

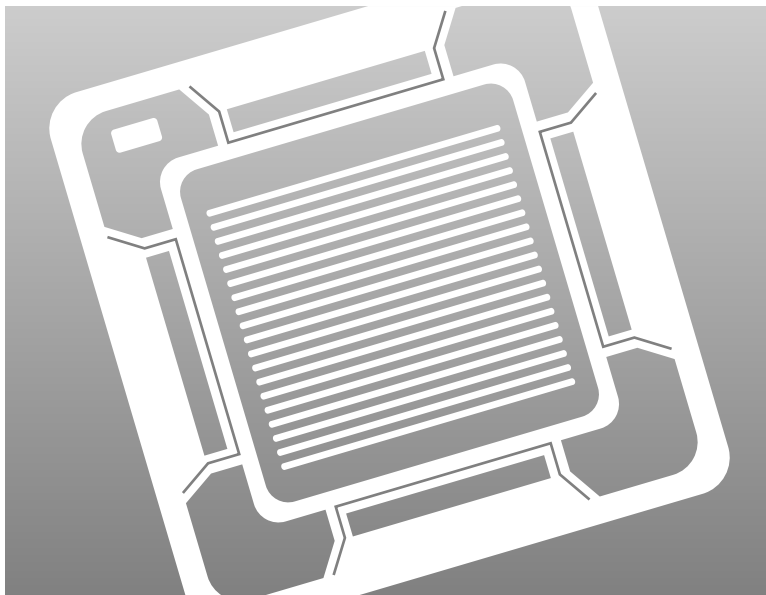

**OWNER'S INSTRUCTIONS
MANUAL DE INSTRUCCIONES
ISTRUZIONI PER L'USO
MANUAL DE INSTRUÇÕES
MANUEL D'UTILISATION
GEBRAUCHSANWEISUNG
ΟΔΗΓΙΕΣ
ИНСТРУКЦИЯ ДЛЯ ПОЛЬЗОВАТЕЛЯ**

Type	Indoor unit	Outdoor unit
ACH1800E	ICH1800E	UBH1800E
ACH2400E	ICH2400E	UBH2400E
ACH3600G	ICH3600G	UCH3600G
ACH4400G	ICH4400G	UCH4400G
CH18ZA	CH18ZA	CH18ZAX
CH24ZA	CH24ZA	CH24ZAX
CH36ZA	CH36ZA	CH36ZAX
CH44ZA	CH44ZA	CH44ZAX
CH18CA	CH18CA	CH18CAX
CH24CA	CH24CA	CH24CAX
CH36CA	CH36CA	CH36CAX
CH44CA	CH44CA	CH44CAX

Cassette-type Air Conditioner (Cool and Heat)
Aire acondicionador Tipo Casete (Refrigeración y Calefacción)
Condizionatore d'aria Tipo Cassetta (Raffreddamento e Riscaldamento)
Ar Condicionado Tipo Casete (Refrigeração e Aquecimento)
Climatiseur de type Cassette (Refroidissement et Chauffage)
Tonbandkassette Klimaanlage (Kühlen und Wärmen)
Κλιματιστικό Τύπου Αεραγωγού (Ψύξη και Θέρμανση)
Кондиционер кассетного типа (Охлаждение и обогрев)



ENGLISH

ESPAÑOL

ITALIANO

PORTUGUÊS

FRANÇAIS

DEUTSCH

ΕΛΛΗΝΙΚΑ

RUSSIAN

Safety Precautions

The following safety precautions must be taken when using your air conditioner.



WARNING

Risk of electric shock. • Can cause injury or death. • Disconnect all remote electric power supplies before servicing, installing or cleaning. • This must be done by the manufacturer or its service agent or a similar qualified person in order to avoid a hazard.

DURING OPERATION

- ◆ Users of this product are cautioned not to attempt repair of this product at their own discretion. Instead, they are requested to directly contact a designated service center or the outlet at which the product was purchased.
- ◆ Never spill any kind of liquid into the unit. Should this happen, unplug or main switch off the unit and contact an authorized service center.
- ◆ Do not insert anything between the air outlet blades because the inner fan may be damaged and could cause injury. Keep children away from the unit.
- ◆ Do not place any obstacles in front of the unit.
- ◆ Do not spray liquid of any kind into the indoor unit. Should this happen, switch off the breaker used for your air conditioner and contact your installation specialist.
- ◆ Make sure that the unit is correctly ventilated at all times:
Do not place clothing or other materials over it.
- ◆ If the wireless remote control will not be used for a long time, remove the batteries. (If applicable)
- ◆ When using a wireless remote control, the distance should not be more than 7 meters from the air conditioner. (If applicable)

DISPOSING OF THE UNIT

- ◆ Before throwing out the device, it is necessary to pull back the battery cells and get rid of them safely for recycling reasons.
- ◆ When you need to dispose of the unit, consult your dealer. If pipes are removed incorrectly, refrigerant may blow out and come into contact with your skin, causing injury. Releasing refrigerant into the atmosphere also damages the environments.
- ◆ Please recycle or dispose of the packaging material for this product in an environmentally responsible manner.

OTHERS

- ◆ Never store or ship the air conditioner upside down or sideways to avoid damage to the compressor.
- ◆ The appliance is not intended for use by young children or infirm persons without supervision: Young children should be supervised to ensure that they do not play with the appliance.
- ◆ Max current is measured according to IEC standard for safety and current is measured according to ISO standard for energy efficiency.

Contents

- ◆ **PREPARING YOUR AIR CONDITIONER**
 - Safety Precautions2
 - View of the Unit4
 - Wired Remote Controller-Buttons and Display6
 - Wireless Remote Controller-Buttons and Display7
 - Centralized Controller8
 - The Indicators on the Unit (For Wireless Remote Controller Only)9
 - Getting Start10
 - Inserting the Wireless Remote Controller Batteries11

USING WIRED REMOTE CONTROLLER

- ◆ **OPERATING YOUR AIR CONDITIONER**
 - Selecting the Automatic Operating Mode13
 - Cooling Your Room14
 - Heating Your Room15
 - Removing Excess Humidity16
 - Airing Your Room17
 - Adjusting the Air Flow Direction17
- ◆ **PROGRAMMING YOUR AIR CONDITIONER**
 - Setting the On Timer18
 - Setting the Off Timer19

USING WIRELESS REMOTE CONTROLLER

- ◆ **OPERATING YOUR AIR CONDITIONER**
 - Selecting the Automatic Operating Mode21
 - Cooling Your Room22
 - Heating Your Room23
 - Removing Excess Humidity24
 - Airing Your Room25
 - Adjusting the Air Flow Direction25
- ◆ **PROGRAMMING YOUR AIR CONDITIONER**
 - Setting the On Timer26
 - Setting the Off Timer27

USING CENTRALIZED CONTROLLER

- Using the Centralized Controller28
- ◆ **RECOMMENDATIONS FOR USE**
 - Operating Recommendations29
 - Cleaning Your Air Conditioner30
 - Bio-Pure Filter Installation(Optional)31
 - Temperature and Humidity Ranges32
 - Solving Common Problems33
- ◆ **TECHNICAL SPECIFICATIONS**



**Correct Disposal of This Product
(Waste Electrical & Electronic Equipment)**

(Applicable in the European Union and other European countries with separate collection systems)

This marking shown on the product or its literature, indicates that it should not be disposed with other household wastes at the end of its working life. To prevent possible harm to the environment or human health from uncontrolled waste disposal, please separate this from other types of wastes and recycle it responsibly to promote the sustainable reuse of material resources.

Household users should contact either the retailer where they purchased this product, or their local government office, for details of where and how they can take this item for environmentally safe recycling.

Business users should contact their supplier and check the terms and conditions of the purchase contract.

This product should not be mixed with other commercial wastes for disposal.

View of the Unit

The figures are shown in this instruction may differ from yours depending on the model.

Indoor Unit

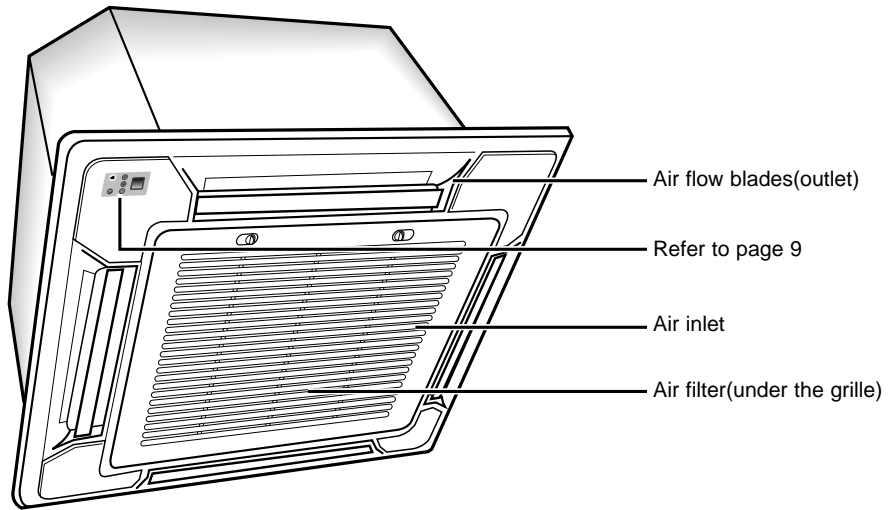

Outdoor Unit

UBH1800E / 2400E
 CH18ZAX / 24ZAX
 CH18CAX / 24CAX

UCH3600G / 4400G
 CH36ZAX / 44ZAX
 CH36CAX / 44CAX

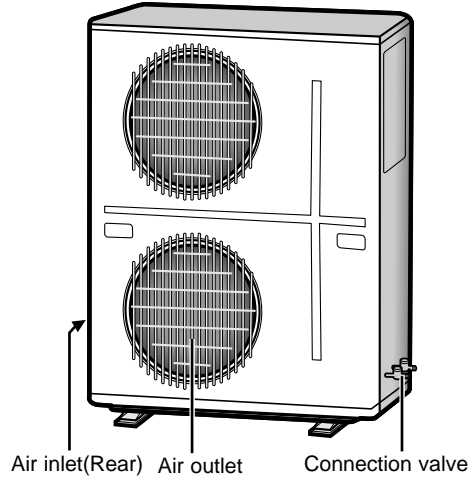
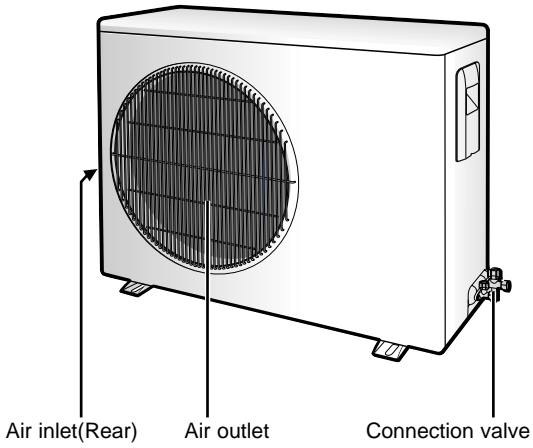

Wired Remote Controller-Buttons and Display

The wired remote controller is an optional accessory.

The wired remote controller is installed on the wall.

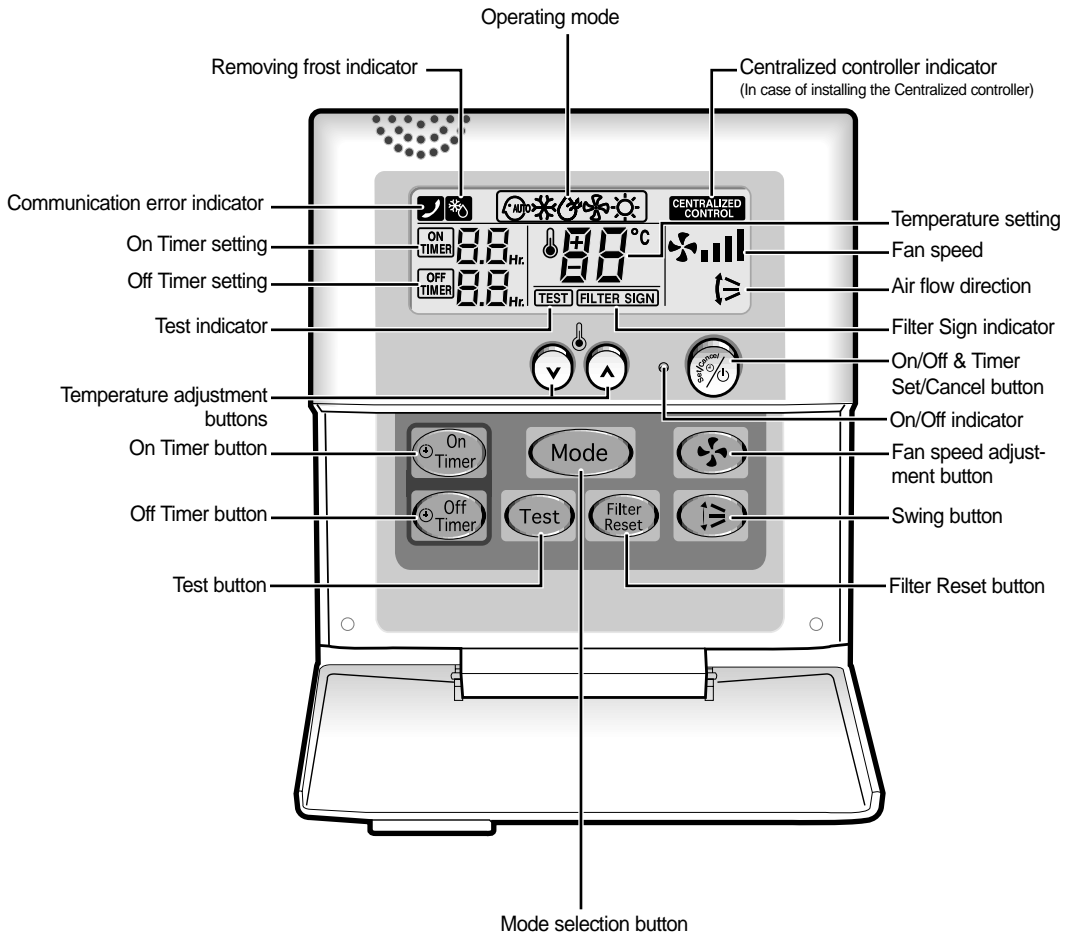

- Note**
- Test button is for your installation specialist. You must NOT press it.
 - After cleaning the air filter, press the filter reset button. Then the wired remote controller will display the FILTER SIGN indicator when the time to clean the air filter; refer to page 30.

Wireless Remote Controller-Buttons and Display

The wireless remote controller is an optional accessory.

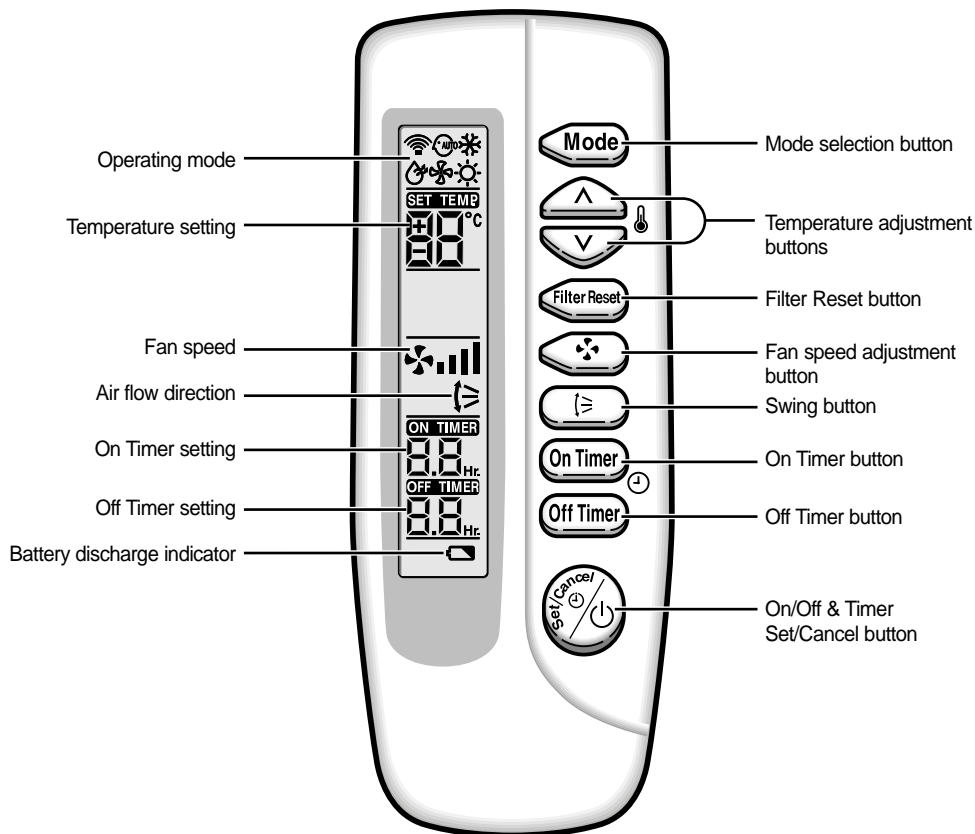

Note After cleaning the air filter, press the filter reset button.

Centralized Controller

The centralized controller is an optional accessory.

The centralized controller is installed on the wall.

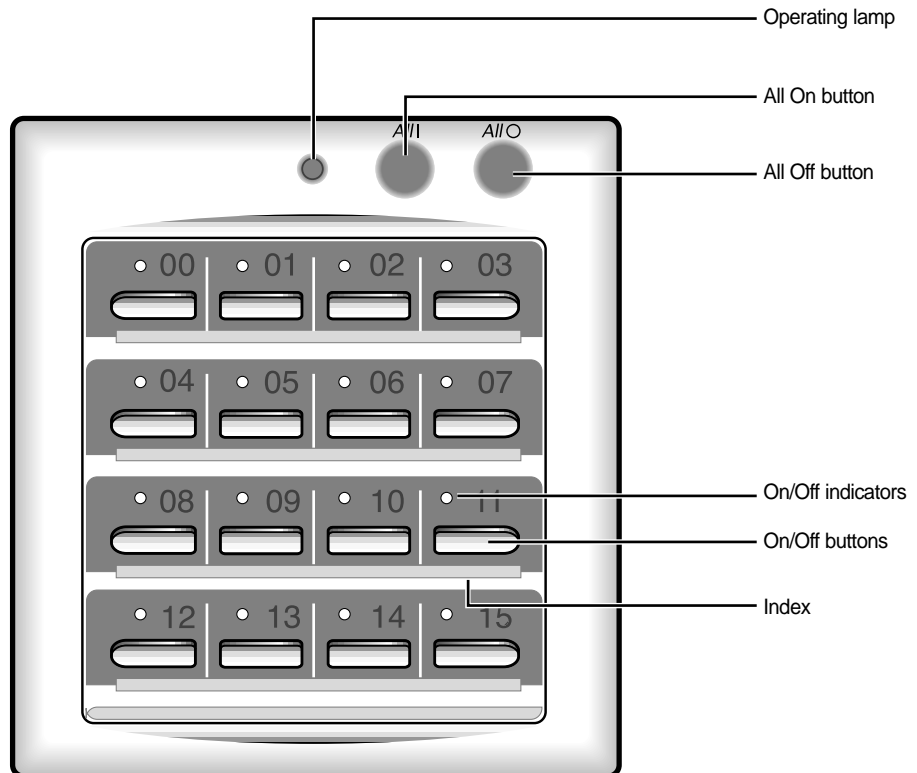

Note Operating lamp comes on when at least one air conditioner connected to the centralized controller is operating.

The Indicators on the Unit (For Wireless Remote Controller Only)

The receiver & display unit is an optional accessory for the wireless remote controller.

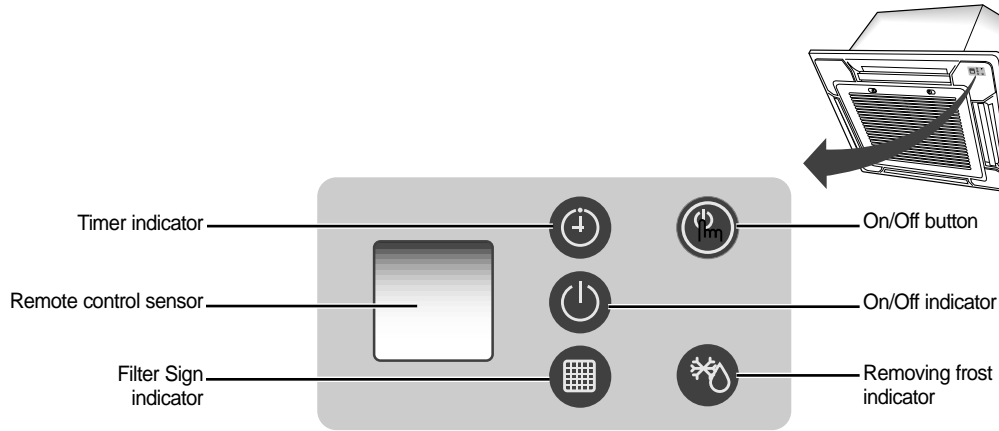

Getting Start

You have just purchased a cassette type air conditioner and it has been installed by your installation specialist.

Your Owner's Instructions contain much valuable information on using your air conditioner. Please take the time to read them as they will help you take full advantage of the unit's features.

The booklet is organized as follows.

- ◆ *The following figures are shown on pages from 4 to 9 :*
 - *Indoor and outdoor units*
 - *Wired remote controller (buttons and display)*
 - *Wireless remote controller (buttons and display)*
 - *Centralized controller*
 - *The indicators on the unit (For wireless remote controller only)*

- ◆ *In the main part of the document, you will find a series of step-by-step procedures for each function available.*

The illustrations in the step-by-step procedures use three different symbols:

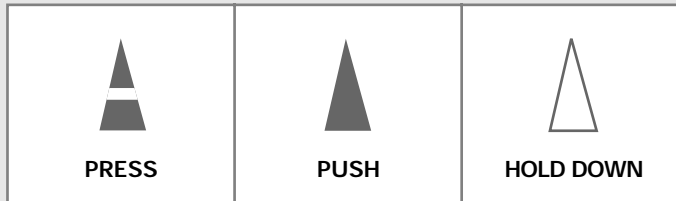

Inserting the Wireless Remote Controller Batteries

You must insert or replace the remote controller batteries when :

- ◆ *You purchase the air conditioner*
- ◆ *The remote controller does not work correctly*

Note

- ◆ Use two AAA, LR03 1.5V batteries.
- ◆ Do not use old batteries or different kinds of batteries together.
- ◆ Batteries may be completely discharged after 12 months, even if they have not actually been used.

- 1 Push the battery cover on the rear of the remote controller with your thumb in the direction of the arrow and remove it.
- 2 Insert the two batteries, taking care to respect the polarities :
 - ◆ + on the battery with + on the remote controller.
 - ◆ - on the battery with - on the remote controller.
- 3 Close the cover by sliding it back until it clicks into place.

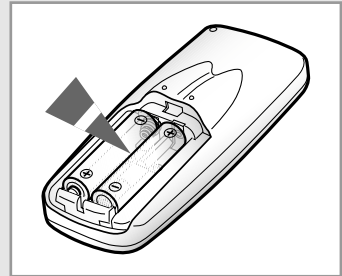
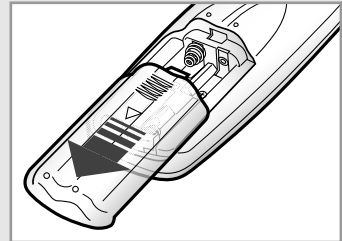

Using Wired Remote Controller

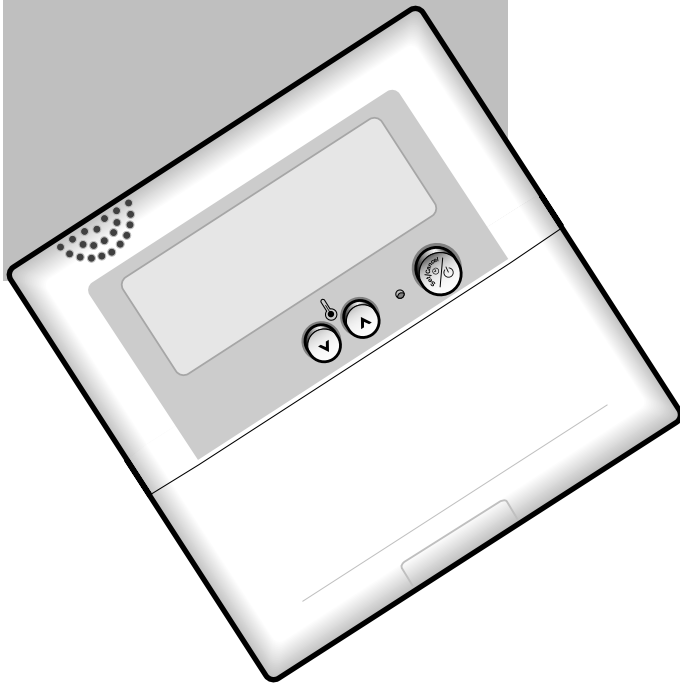

This chapter indicates how to operate and program your air conditioner with the wired remote controller. The wired remote controller is an optional accessory.

Selecting the Automatic Operating Mode

In the Automatic mode, the room temperature and the fan speed are controlled automatically.

- 1 If necessary, press  (ON/OFF) button.

Result:

- ◆ The On/Off indicator on the wired remote controller comes on.
- ◆ The air conditioner runs in the mode selected when the unit was last used.

IMPORTANT The air conditioner is fitted with a protection mechanism to prevent the unit from being damaged when it is started immediately after being:

- ◆ Plugged in
- ◆ Stopped

It will start up normally after three minutes.

- 2 To select the AUTO mode, press the Mode button until  is displayed at the top of the wired remote controller.

Result: ◆ The air conditioner runs in AUTO mode.

Note You can change modes at any time.

- 3 To adjust the temperature, press the Temperature buttons one or more times until the required temperature is displayed. Possible temperatures are between 18°C and 30°C inclusive.

Result:

- ◆ Each time you press Temperature buttons:
 - The temperature is adjusted by 1°C.
- ◆ The air conditioner takes the present temperature of the room every 30 minutes.
 - If the temperature is higher than the selected temperature + α , the air conditioner will start cooling.
 - If the temperature is lower than the selected temperature - α , the air conditioner will start heating.

Note The α is a preset temperature for the most comfortable environment. It can be adjusted by your installation specialist when installing the product.

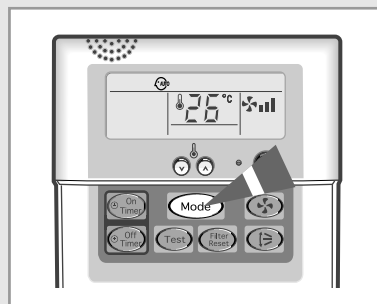
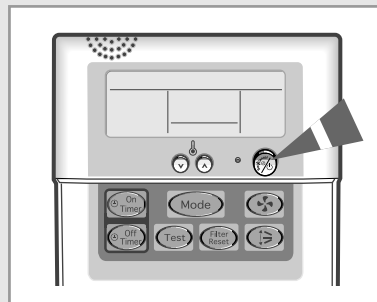

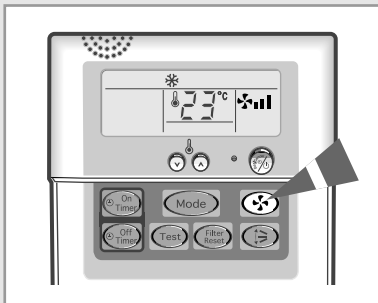
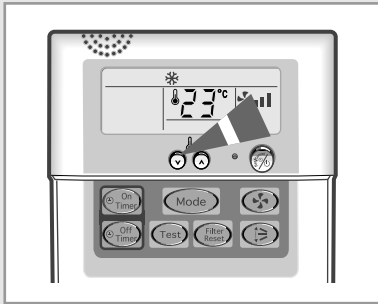
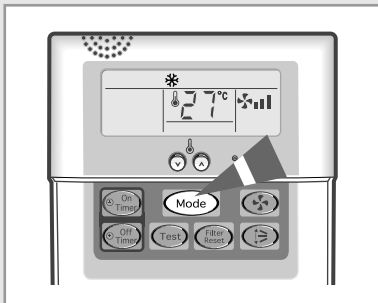
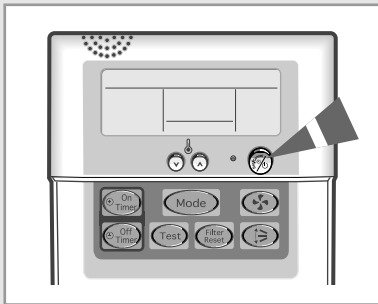

You must select the COOL mode if you wish to adjust the :

- ◆ Cooling temperature
- ◆ Fan speed when cooling

1 If necessary, press (ON/OFF) button.

- Result:**
- ◆ The On/Off indicator on the wired remote controller comes on.
 - ◆ The air conditioner runs in the mode selected when the unit was last used.

IMPORTANT The air conditioner is fitted with a protection mechanism to prevent the unit from being damaged when it is started immediately after being:

- ◆ Plugged in
- ◆ Stopped

It will start up normally after three minutes.

2 To select the COOL mode, press the Mode button until is displayed at the top of the wired remote controller.

- Result:** ◆ The air conditioner runs in COOL mode.

Note You can change modes at any time.

3 To adjust the temperature, press the Temperature buttons one or more times until the required temperature is displayed. Possible temperatures are between 18°C and 30°C inclusive.

- Result:**
- ◆ Each time you press Temperature buttons:
 - The temperature is adjusted by 1°C.
 - ◆ The air conditioner starts cooling, provided that the room temperature is higher than the selected temperature ; the fan will, however, operate.

4 Select the fan speed by pressing the Fan button one or more times until the intended value is displayed :

- Automatic (rotated : → →)
- Low
- Medium
- High

5 To control the direction of the air flow, refer to page 17.

Heating Your Room

You must select the HEAT mode if you wish to adjust the :

- ◆ Heating temperature
- ◆ Fan speed when heating

1 If necessary, press (ON/OFF) button.

- Result:**
- ◆ The On/Off indicator on the wired remote controller comes on.
 - ◆ The air conditioner runs in the mode selected when the unit was last used.

IMPORTANT The air conditioner is fitted with a protection mechanism to prevent the unit from being damaged when it is started immediately after being:

- ◆ Plugged in
- ◆ Stopped

It will start up normally after three minutes.

2 To select the HEAT mode, press the Mode button until is displayed at the top of the wired remote controller.

Result: ◆ The air conditioner runs in HEAT mode.

Note You can change modes at any time.

3 To adjust the temperature, press the Temperature buttons one or more times until the required temperature is displayed. Possible temperatures are between 16°C and 30°C inclusive.

- Result:**
- ◆ Each time you press Temperature buttons:
 - The temperature is adjusted by 1°C.
 - ◆ The air conditioner starts heating, provided that the room temperature is lower than the selected temperature ; the fan will, however, operate.

4 Select the fan speed by pressing the Fan button one or more times until the intended value is displayed :

- Automatic (rotated :)
- Low
- Medium
- High

5 To control the direction of the air flow, refer to page 17.

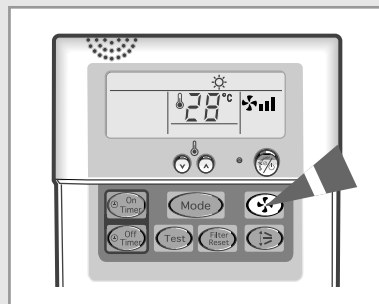
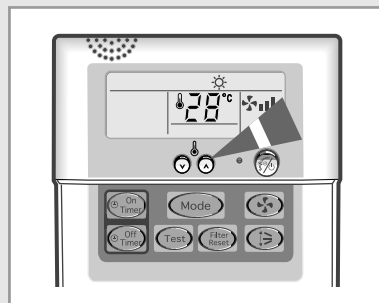
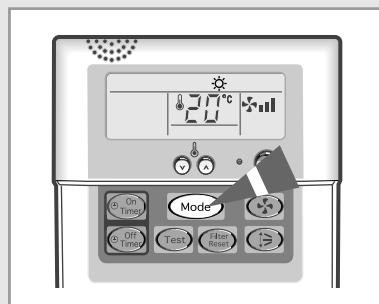
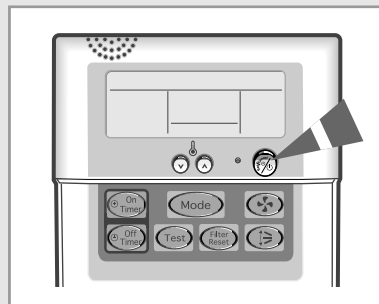

Removing Excess Humidity

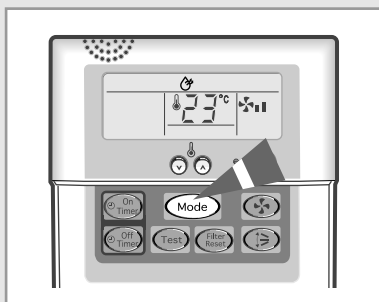
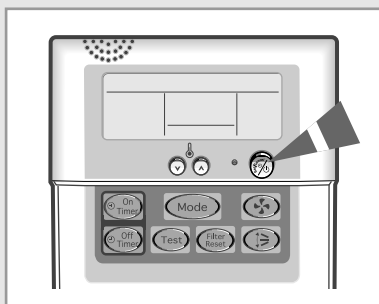

If the atmosphere in your room is very humid or damp, you can remove excess humidity without lowering the room temperature too much.

- 1 If necessary, press  (ON/OFF) button.

Result:

- ◆ The On/Off indicator on the wired remote controller comes on.
- ◆ The air conditioner runs in the mode selected when the unit was last used.

IMPORTANT The air conditioner is fitted with a protection mechanism to prevent the unit from being damaged when it is started immediately after being:

- ◆ Plugged in
- ◆ Stopped

It will start up normally after three minutes.

- 2 To select the DRY mode, press the Mode button until  is displayed at the top of the wired remote controller.

Result: ◆ The air conditioner runs in DRY mode.

Note You can change modes at any time.

- 3 To adjust the temperature, press the Temperature buttons one or more times until the required temperature is displayed. Possible temperatures are between 18°C and 30°C inclusive.

Result:

- ◆ Each time you press Temperature buttons:
 - The temperature is adjusted by 1°C.
- ◆ The air conditioner starts removing the excess humidity. The quantity of air is adjusted automatically.

Note In the dry mode, the fan speed is controlled automatically.

- 4 To control the direction of the air flow, refer to page 17.



Airing Your Room

If the atmosphere in your room is stale, you can air it using the FAN feature.

- 1 If necessary, press (ON/OFF) button.

Result:

- ◆ The On/Off indicator on the wired remote controller comes on.
- ◆ The air conditioner runs in the mode selected when the unit was last used.

- 2 To select the FAN mode, press the Mode button until is displayed at the top of the wired remote controller.

Result: ◆ The air conditioner runs in FAN mode.

- 3 Select the fan speed by pressing the Fan button one or more times until the intended value is displayed:

	Low
	Medium
	High

- 4 To control the direction of the air flow, refer to below.

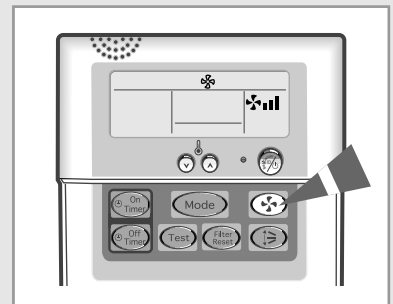
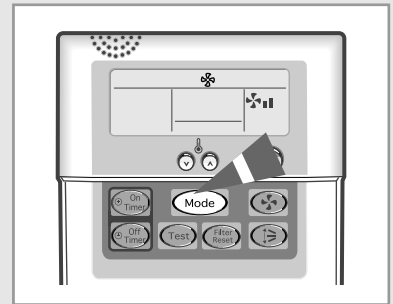

Adjusting the Air Flow Direction

Depending on the position of the indoor unit, you can adjust the position of the air flow blades, thus increasing the efficiency of the air conditioner.

- 1 Press the Swing button.

Result: The blades are moving between up and down.

IMPORTANT When the air conditioner is first turned on, the blades are moved.

- 2 To stop the blades, press the Swing button again.
To set to the required position, press the Swing button again.
When the blades are in the required position.

Note You can also adjust by the hands the blades which are not operated by the Swing button.

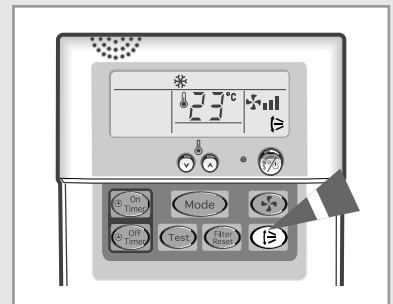

Setting the On Timer

The On Timer enables you to switch on the air conditioner automatically after a given period of time. You can set the period of time from 30 minutes to 24 hours.

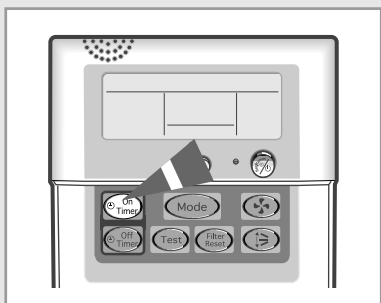
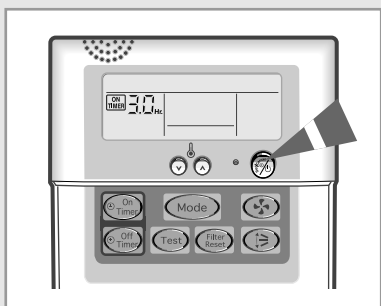
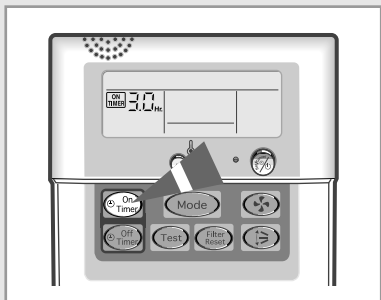

- 1 To set the operating time, press the On Timer button one or more times until the required time is displayed. Possible time is between 0.5 hour and 24 hours inclusive.

Result: ◆ Each time you press On Timer button:
- The time is adjusted by 0.5 hour to 5 hours, by 1 hour from 6 hours to 24 hours.

- 2 Press the  (Set/Cancel) button to complete the setting.

Result: ◆ The remaining time is displayed.
◆ Blinking of the timer indicator stops.
◆ The selected mode and the temperature disappear on the display after 5 seconds.
◆ The air conditioner will switch on automatically when the counter displayed on the remote controller reaches the setting time as disappearing the On timer setting.

Note You can see or change the setting mode and/or the temperature by pressing the Mode button or the Temperature buttons after setting the On timer.

To Cancel the On Timer

- 1 To cancel the On Timer, press the On Timer button one or more times until the On timer setting disappears.

- 2 Press the  (Set/Cancel) button.

Note If you want to turn on the air conditioner before the timer reaches the setting time, press the  (ON/OFF) button.

Setting the Off Timer

The Off Timer enables you to switch off the air conditioner automatically after a given period of time. You can set the period of time from 30 minutes to 24 hours.

- To set the operating time, press the Off Timer button one or more times until the required time is displayed. Possible time is between 0.5 hour and 24 hour inclusive.

Result: ◆ Each time you press Off Timer button:
- The time is adjusted by 0.5 hour to 5 hours, by 1 hour from 6 hours to 24 hours.

- Press the (Set/Cancel) button to complete the setting.

Result: ◆ The remaining time is displayed.
◆ Blinking of the timer indicator stops.
◆ The selected mode and the temperature disappear on the display after 5 seconds.
◆ The air conditioner will switch off automatically when the counter displayed on the remote controller reaches the setting time as disappearing the Off timer setting.

Example If you would like to turn the air conditioner on after 2 hours and to operate it for 2 hours:

- Press the On Timer button until '2.0 Hr' is displayed.
- Press the (Set/Cancel) button.
- Press the Off Timer button until '4.0 Hr' is displayed.
- Press the (Set/Cancel) button.

Note You can see or change the setting mode and/or the temperature by pressing the Mode button or the Temperature buttons after setting the Off timer.

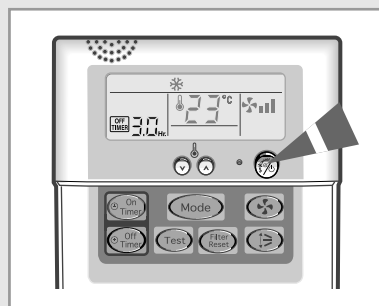
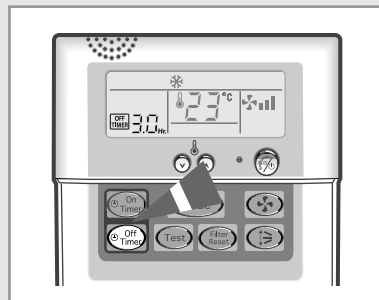

To Cancel the Off Timer

- To cancel the Off Timer, press the Off Timer button one or more times until the timer setting disappears.

- Press the (Set/Cancel) button.

Note If you want to turn off the air conditioner before the timer reaches the setting time, press the (ON/OFF) button.

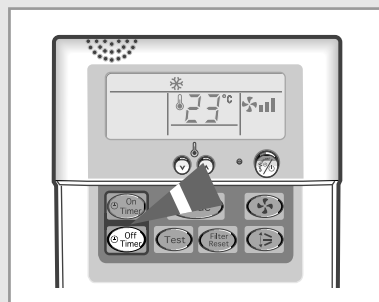

Using Wireless Remote Controller

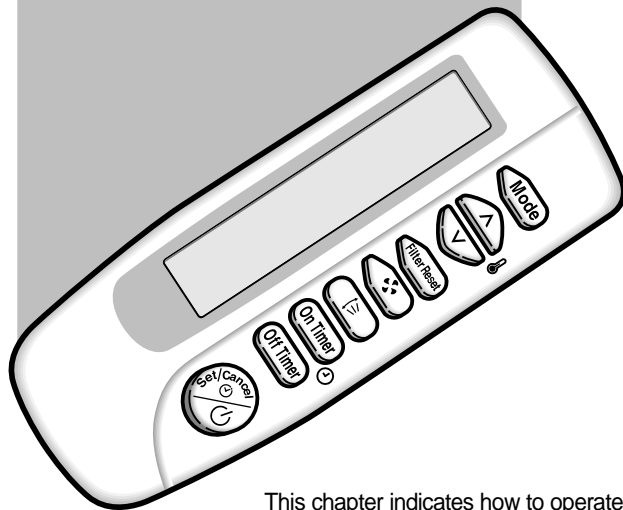

This chapter indicates how to operate and program your air conditioner with the wireless remote controller. The wireless remote controller is an optional accessory.

Selecting the Automatic Operation Mode

In the Automatic mode, the room temperature and the fan speed are controlled automatically.

- 1 If necessary, press  (ON/OFF) button.

Result:

- ◆ The On/Off indicator on the unit comes on.
- ◆ The air conditioner runs in the mode selected when the unit was last used.
- ◆ The indoor unit beeps.

IMPORTANT The air conditioner is fitted with a protection mechanism to prevent the unit from being damaged when it is started immediately after being:

- ◆ Plugged in
- ◆ Stopped

It will start up normally after three minutes.

- 2 To select the AUTO mode, press the Mode button until  is displayed at the top of the wireless remote controller.

Result:

- ◆ The indoor unit beeps.
- ◆ The air conditioner runs in AUTO mode.

Note You can change modes at any time.

- 3 To adjust the temperature, press the Temperature buttons one or more times until the required temperature is displayed. Possible temperatures are between 18°C and 30°C inclusive.

Result:

- ◆ Each time you press Temperature buttons:
 - The temperature is adjusted by 1°C.
- ◆ The air conditioner takes the present temperature of the room every 30 minutes.
 - If the temperature is higher than the selected temperature + α , the air conditioner will start cooling.
 - If the temperature is lower than the selected temperature - α , the air conditioner will start heating.

Note The α is a preset temperature for the most comfortable environment. It can be adjusted by your installation specialist when installing the product.

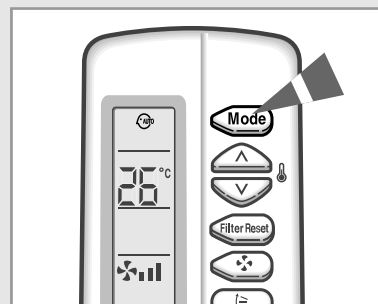
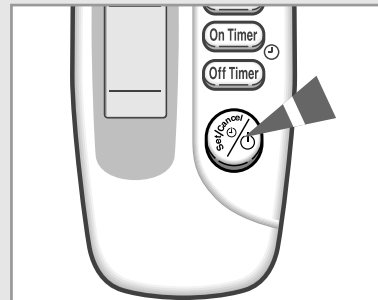

Cooling Your Room

You must select the COOL mode if you wish to adjust the :

- ◆ Cooling temperature
- ◆ Fan speed when cooling

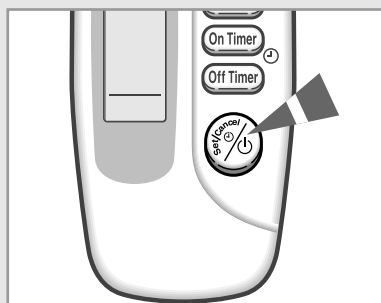

1 If necessary, press (ON/OFF) button.

- Result:
- ◆ The On/Off indicator on the unit comes on.
 - ◆ The air conditioner runs in the mode selected when the unit was last used.
 - ◆ The indoor unit beeps.

IMPORTANT The air conditioner is fitted with a protection mechanism to prevent the unit from being damaged when it is started immediately after being:

- ◆ Plugged in
- ◆ Stopped

It will start up normally after three minutes.

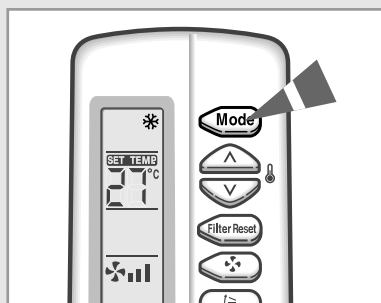

2 To select the COOL mode, press the Mode button until is displayed at the top of the wireless remote controller.

- Result:
- ◆ The indoor unit beeps.
 - ◆ The air conditioner runs in COOL mode.

Note You can change modes at any time.

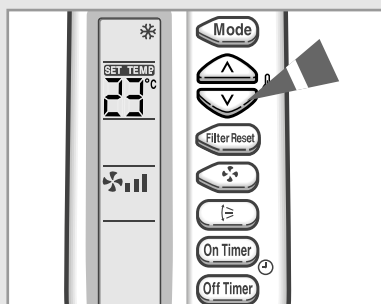

3 To adjust the temperature, press the Temperature buttons one or more times until the required temperature is displayed. Possible temperatures are between 18°C and 30°C inclusive.

- Result:
- ◆ Each time you press Temperature buttons:
 - The temperature is adjusted by 1°C.
 - The indoor unit beeps.
 - ◆ The air conditioner starts cooling, provided that the room temperature is higher than the selected temperature ; the fan will, however, operate.

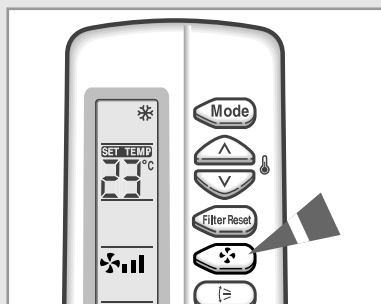

4 Select the fan speed by pressing the Fan button one or more times until the intended value is displayed :

- Automatic (rotated : → →)
- Low
- Medium
- High

5 To control the direction of the air flow, refer to page 25.

Heating Your Room

You must select the HEAT mode if you wish to adjust the :

- ◆ Heating temperature
- ◆ Fan speed when heating

1 If necessary, press (ON/OFF) button.

- Result:**
- ◆ The On/Off indicator on the unit comes on.
 - ◆ The air conditioner runs in the mode selected when the unit was last used.
 - ◆ The indoor unit beeps.

IMPORTANT The air conditioner is fitted with a protection mechanism to prevent the unit from being damaged when it is started immediately after being:

- ◆ Plugged in
- ◆ Stopped

It will start up normally after three minutes.

2 To select the HEAT mode, press the Mode button until is displayed at the top of the wireless remote controller.

- Result:**
- ◆ The indoor unit beeps.
 - ◆ The air conditioner runs in HEAT mode.

Note You can change modes at any time.

3 To adjust the temperature, press the Temperature buttons one or more times until the required temperature is displayed. Possible temperatures are between 16°C and 30°C inclusive.

- Result:**
- ◆ Each time you press Temperature buttons:
 - The temperature is adjusted by 1°C.
 - The indoor unit beeps.
 - ◆ The air conditioner starts heating, provided that the room temperature is lower than the selected temperature ; the fan will, however, operate.

4 Select the fan speed by pressing the Fan button one or more times until the intended value is displayed :

- Automatic (rotated : → →)
- Low
- Medium
- High

5 To control the direction of the air flow, refer to page 25.

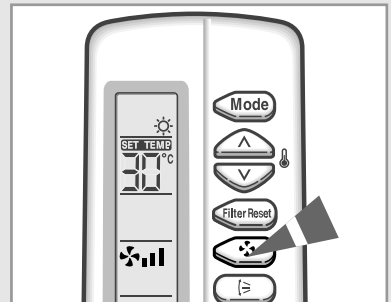
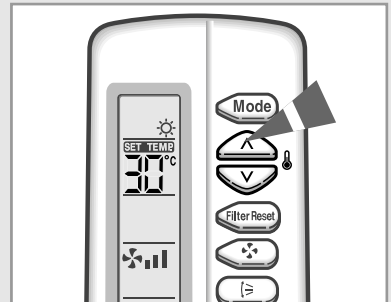
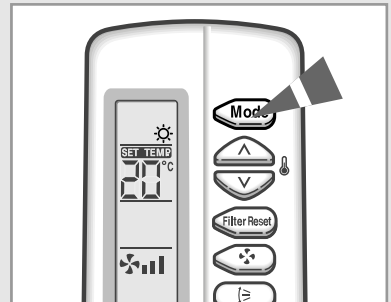
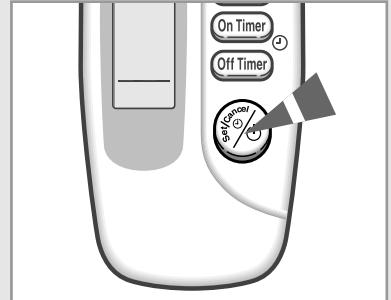

Removing Excess Humidity

If the atmosphere in your room is very humid or damp, you can remove excess humidity without lowering the room temperature too much.

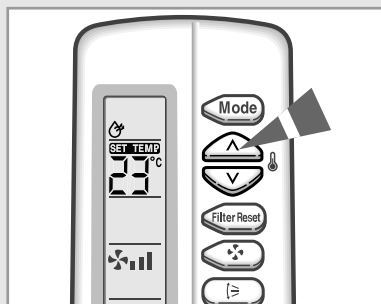
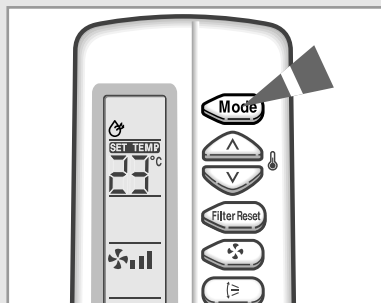
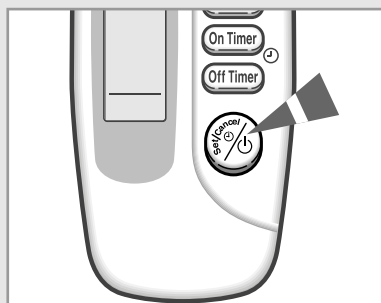

- 1 If necessary, press  (ON/OFF) button.

Result:

- ◆ The On/Off indicator on the unit comes on.
- ◆ The air conditioner runs in the mode selected when the unit was last used.
- ◆ The indoor unit beeps.

IMPORTANT The air conditioner is fitted with a protection mechanism to prevent the unit from being damaged when it is started immediately after being:

- ◆ Plugged in
- ◆ Stopped

It will start up normally after three minutes.

- 2 To select the DRY mode, press the Mode button until  is displayed at the top of the wireless remote controller.

Result:

- ◆ The indoor unit beeps.
- ◆ The air conditioner runs in DRY mode.

Note You can change modes at any time.

- 3 To adjust the temperature, press the Temperature buttons one or more times until the required temperature is displayed. Possible temperatures are between 18°C and 30°C inclusive.

Result:

- ◆ Each time you press Temperature buttons:
 - The temperature is adjusted by 1°C.
 - The indoor unit beeps.
- ◆ The air conditioner starts removing the excess humidity. The quantity of air is adjusted automatically.

Note In the dry mode, the fan speed is controlled automatically.

- 4 To control the direction of the air flow, refer to page 25.

Airing Your Room

If the atmosphere in your room is stale, you can air it using the FAN feature.

- 1 If necessary, press (ON/OFF) button.

Result:

- ◆ The On/Off indicator on the unit comes on.
- ◆ The air conditioner runs in the mode selected when the unit was last used.
- ◆ The indoor unit beeps.

- 2 To select the FAN mode, press the Mode button until is displayed at the top of the wired remote controller.

Result:

- ◆ The indoor unit beeps.
- ◆ The air conditioner runs in FAN mode.

Note You can change modes at any time.

- 3 Select the fan speed by pressing the Fan button one or more times until the intended value is displayed:

- Low
- Medium
- High

- 4 To control the direction of the air flow, refer to below.

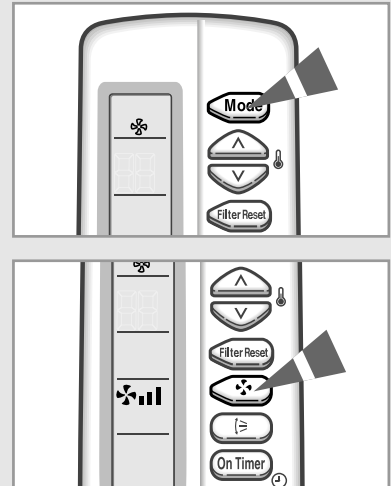

Adjusting the Air Flow Direction

Depending on the position of the indoor unit, you can adjust the position of the air flow blades, thus increasing the efficiency of the air conditioner.

- 1 Press the Swing button.

Result:

- ◆ The blades are moving between up and down.
- ◆ The indoor unit beeps.

IMPORTANT When the air conditioner is first turned on, the blades are moved.

- 2 To stop the blades, press the Swing button again.
To set to the required position, press the Swing button again.
When the blades are in the required position.

Note You can also adjust by the hands the blades which are not operated by the swing button.

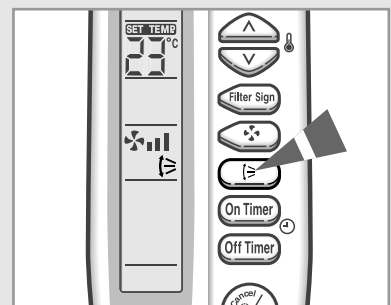

Setting the On Timer

The On Timer enables you to switch on the air conditioner automatically after a given period of time. You can set the period of time from 30 minutes to 24 hours.

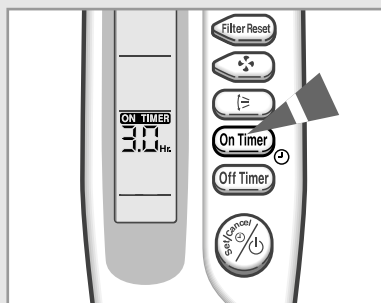

- 1 To set the operating time, press the On Timer button one or more times until the required time is displayed. Possible time is between 0.5 hour and 24 hour inclusive.

Result: ◆ Each time you press On Timer button:
- The time is adjusted by 0.5 hour to 5 hours, by 1 hour from 6 hours to 24 hours.

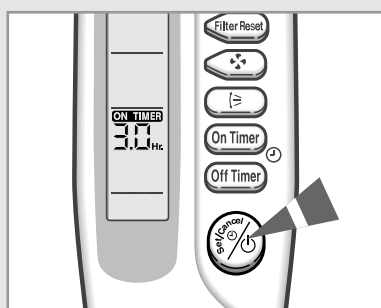

- 2 Press the (Set/Cancel) button to complete the setting.

Result: ◆ The remaining time is displayed.
◆ Blinking of the timer indicator stops.
◆ The selected mode and the temperature disappear on the display after 5 seconds.
◆ The air conditioner will switch on automatically when the counter displayed on the remote controller reaches the setting time as disappearing the On timer setting.

Note You can see or change the setting mode and/or the temperature by pressing the Mode button or the Temperature buttons after setting the On timer.

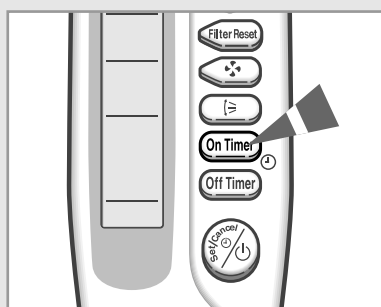

- 1 To cancel the On Timer, press the On Timer button one or more times until the timer setting disappears.

- 2 Press the (Set/Cancel) button.

Note If you want to turn on the air conditioner before the timer reaches the setting time, press the (ON/OFF) button.

Setting the Off Timer

The Off Timer enables you to switch off the air conditioner automatically after a given period of time. You can set the period of time from 30 minutes to 24 hours.

- To set the operating time, press the Off Timer button one or more times until the required time is displayed. Possible time is between 0.5 hour and 24 hour inclusive.

Result:



- ◆ Each time you press Off Timer button:
 - The time is adjusted by 0.5 hour to 5 hours, by 1 hour from 6 hours to 24 hours.

- Press the  (Set/Cancel) button to complete the setting.

Result:

- ◆ The remaining time is displayed.
- ◆ Blinking of the timer indicator stops.
- ◆ The selected mode and the temperature disappear on the display after 5 seconds.
- ◆ The air conditioner will switch off automatically when the counter displayed on the remote controller reaches the setting time as disappearing the Off timer setting.

Example If you would like to turn the air conditioner on after 2 hours and to operate it for 2 hours:

- Press the On Timer button until '2.0 Hr' is displayed.
- Press the  (Set/Cancel) button.
- Press the Off Timer button until '4.0 Hr' is displayed.
- Press the  (Set/Cancel) button.

Note You can see or change the setting mode and/or the temperature by pressing the Mode button or the Temperature buttons after setting the Off timer.

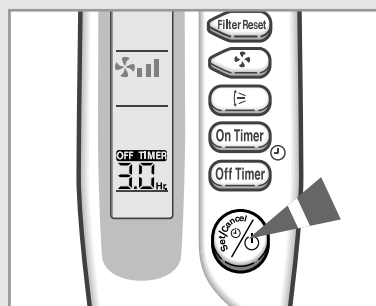
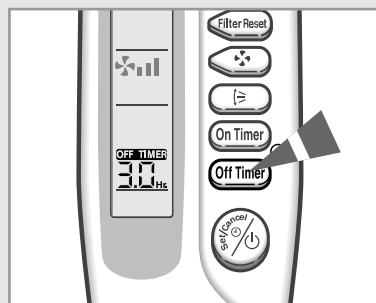

To Cancel the Off Timer

- To cancel the Off Timer, press the Off Timer button one or more times until the timer setting disappears.

- Press the  (Set/Cancel) button.

Note If you want to turn off the air conditioner before the timer reaches the setting time, press the  (ON/OFF) button.

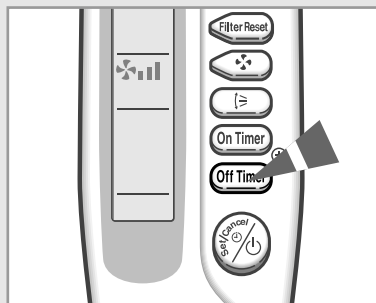

Using the Centralized Controller

The centralized controller is an optional accessory.

*Up to sixteen air conditioners can be turned on or off by connecting to the centralized controller. However, you cannot adjust the cooling/heating temperature or set the timer with it. If you also have the wired remote controller, **CENTRALIZED CONTROL** is displayed at the top of the remote controller.*

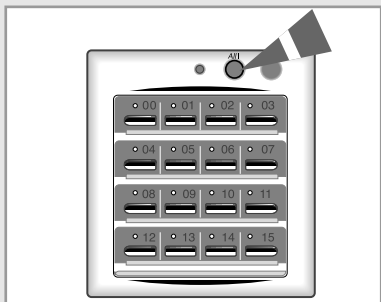

- 1 To turn on the all of air conditioners connected to the centralized controller, press the  (All ON) button.

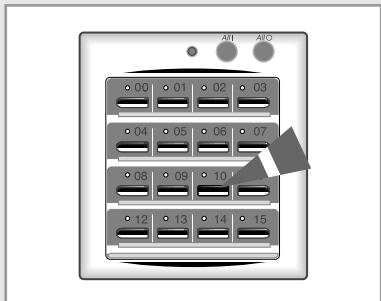

- 2 To turn on/off a specific air conditioner, press the  (ON/OFF) button.
Result: ◆ The On/Off indicator comes on when the air conditioner is operating.

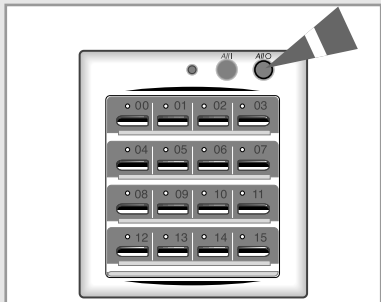

- 3 To turn off the all of air conditioners connected to the centralized controller, press the  (All OFF) button.

Operating Recommendations

Here are a few recommendations that you should follow when operating your air conditioner.

Topic	Recommendation
Heating performances	The heat pump function of the air conditioner absorbs heat from outside air and brings it indoors. As the temperature of the outside air drops, the heating performance of air conditioner will decrease. If you find that the room is not warm enough, using an additional heating appliance is recommended.
Frost	When outside temperature is low but humidity is high, frost may form on the outdoor unit at HEAT mode. If this happens: <ul style="list-style-type: none"> ◆ The heating operation stops. ◆ The defrost mode will be triggered automatically for about ten minutes. No intervention is required ; after about ten minutes, the air conditioner operates again normally.
High indoor and outdoor temperatures	If both indoor and outdoor temperatures are high and the air conditioner is running at HEAT mode, the outdoor unit's fan and compressor may stop at times. This is normal ; simply wait until the air conditioner switches on again.
Power failure	If a power failure occurs while the air conditioner is operating, the unit will be switched off. When the power returns, the air conditioner restarts in the previous operation mode.

Cleaning Your Air Conditioner

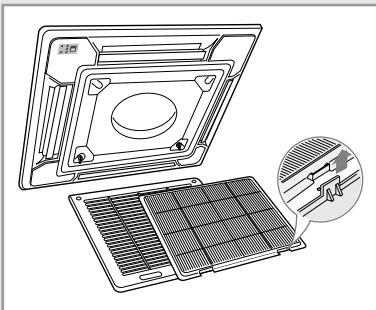
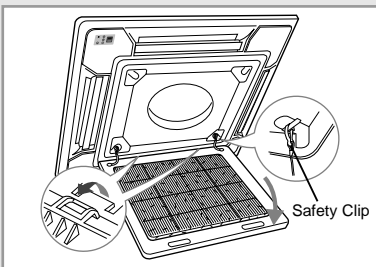
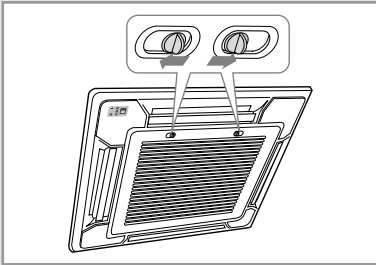

To get the best possible use out of your air conditioner, you must clean it regularly to remove the dust that accumulates on the air filter.

IMPORTANT Before cleaning your air conditioner, ensure that you have switched off the electric circuit breaker used for the unit.

1 Open the front grille by pushing the tabs on the grille.

IMPORTANT You must give attention when disassembling the front grille and must check the safety clips have been installed. If you do not check them, the front grille will drop suddenly and you will be hurt.

2 Remove the front grille.

2-1 Remove the safety clips.

2-2 Open the front grille about 45° and pull it forward.

3 Pull out the air filter.

4 Remove all dust on air filter with a vacuum cleaner or a brush. In case of serious dust accumulation, put the air filter in warm detergent water and shake it vertically.

Note When you have installed the Bio-Pure filter, do not allow any liquids to contact the filter. It may lose its properties.

5 Dry the air filter.

6 When you have finished, insert the filter into the front grille.

7 Clean the unit with a vacuum cleaner or a brush once a month.

8 Reinstall the front grille and the safety clips.

Note You can use all 4 points of the indoor unit for installing the front grille and the safety clips depending on your requirement.

Note After cleaning the air conditioner, press the Filter Reset button.

Wired Remote Controller

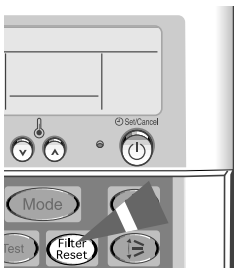

Wireless Remote Controller

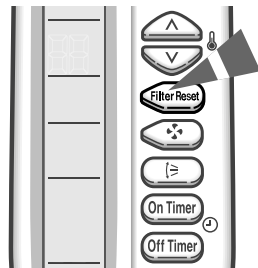

Bio-Pure Filter Installation (Optional)

The air conditioner can be fitted with a Bio-Pure filter to remove minute dust particles. The service life of the filter is approximately three months depending on the time during which the air conditioner is used.

- 1 Remove the vinyl packing from the filter.

Note Do not remove the packing from a bio-pure filter until you wish to use the filter, as it will lose its properties.

- 2 Open the front grille by pulling the tabs on the grille.

- 3 Remove the front grille.

3-1 Remove the safety clips.

3-2 Open the front grille about 45° and pull it forward.

- 4 Pull out the air filter.

- 5 Locate the bio-pure filter on the center of air filter.

- 6 Secure the bio-pure filter with four screws.

- 7 Reinstall the air filter, the front grille and the safety clips.

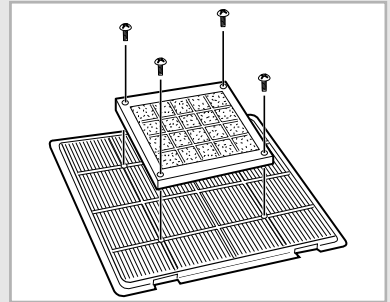

Temperature and Humidity Ranges

The following table indicates the temperature and humidity ranges, within which the air conditioner can be used.



If the air conditioner is used at...	Then...
High temperature	The automatic protection feature may be triggered and the air conditioner stopped.
Low temperature	A water leakage or some other malfunction may happen if the heat exchanger freezes.
High humidity levels	Water may condense on and drip from the surface of the indoor unit if it is used for a long periods.

Mode	Outdoor Temperature	Indoor Temperature	Indoor Humidity
Heating	-5°C to 21°C approx.	15°C to 27°C approx.	-
Cooling	-5°C to 43°C approx.	21°C to 32°C approx.	80% or less
Drying	21°C to 43°C approx.	21°C to 32°C approx.	-

- ※ *If the heating operation is used at below 0°C(outdoor temperature) then, does not a full capacity.
If the cooling operation is used at over 33°C(indoor temperature) then, does not a full capacity.*

Solving Common Problems

Before contacting the after-sales service, perform the following simple checks. They may save your time and expense of an unnecessary call.

Problem	Explanation/Solution
The air conditioner does not operate at all	<ul style="list-style-type: none"> ◆ Check that the breaker used for the air conditioner is switched on.
Wired Remote Controller	
The air conditioner does not operate with the remote controller	<ul style="list-style-type: none"> ◆  is displayed on the wired remote controller. In this case, turn the air conditioner off and contact your dealer.
Wired Remote Controller	
When turning on/off the air conditioner, it is not turned on/off immediately.	<ul style="list-style-type: none"> ◆ In case of using the wired remote controller for a group, the air conditioners connected to the remote controller are turned on/off in order. Thus, it takes some time (up to 32 seconds).
Wireless Remote Controller	
The air conditioner does not operate with the remote controller	<ul style="list-style-type: none"> ◆ Check that there are no obstacles between you and the remote control sensor. ◆ Check the wireless remote controller batteries (Refer to page 11). ◆ Check that you are close enough to the remote control sensor. (seven metres/yards or less).
Wireless Remote Controller	
No beep is heard when you press  (ON/OFF) on the remote controller	<ul style="list-style-type: none"> ◆ Check that you are pointing the remote controller at the remote control sensor of the receiver & display unit. ◆ Replace the remote controller batteries if necessary. ◆ If there is a strong light around the air conditioner, a three-wavelength light, a neon sign, ect., for example, the air conditioner may not be operated with a remote controller. If this happens, use the remote controller close by the remote control sensor.
The air conditioner does not cool or heat	<ul style="list-style-type: none"> ◆ Check that the correct operating mode has been selected. ◆ The room temperature may be too low or too high. ◆ Dust may be blocking the air filter guard; refer to page 30 for cleaning instructions. ◆ Check that there is no obstacle in front of the outdoor unit.
When heating, the required room temperature is never reached and the air conditioner frequently stops	<ul style="list-style-type: none"> ◆ Check that the required temperature has been set correctly. ◆ Increase the fan speed.

Technical Specifications

Model	Power Supply	Package Weight		
		Paper	Plastic	Wood
ACH 1800E	1Ø, 220-240V~, 50Hz			
ACH 2400E				
CH18ZA				
CH24ZA				
CH18CA				
CH24CA				
ACH 3600G	3Ø, 380-415V~, 50Hz			
ACH 4400G				
CH36ZA				
CH44ZA				
CH36CA				
CH44CA				

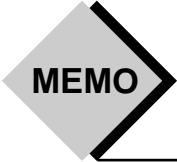

A series of horizontal dotted lines for writing, starting below a solid horizontal line that extends from the right side of the "MEMO" label.

**THIS AIR CONDITIONER IS MANUFACTURED BY:
ESTE AIRE ACONDICIONADO HA SIDO FABRICADO POR:
QUESTO CONDIZIONATORE D'ARIA È PRODOTTO DA:
ESTE APARELHO DE AR CONDICIONADO É FABRICADO POR:
CE CLIMATISEUR EST FABRIQUE PAR:
DIESE KLIMAANLAGE IST FABRIZIERT VON:
ΑΥΤΗ Η ΣΥΣΚΕΥΗ ΚΑΤΑΣΚΕΥΑΣΤΗΚΕ ΑΠΟ :
ЭТОТ КОНДИЦИОНЕР ИЗГОТОВЛЕН ФИРМОЙ:**



ELECTRONICS