

DAEWOO DPN-3500

GPS PORTABLE NAVIGATION

USER MANUAL



1 - Contents What's in the box

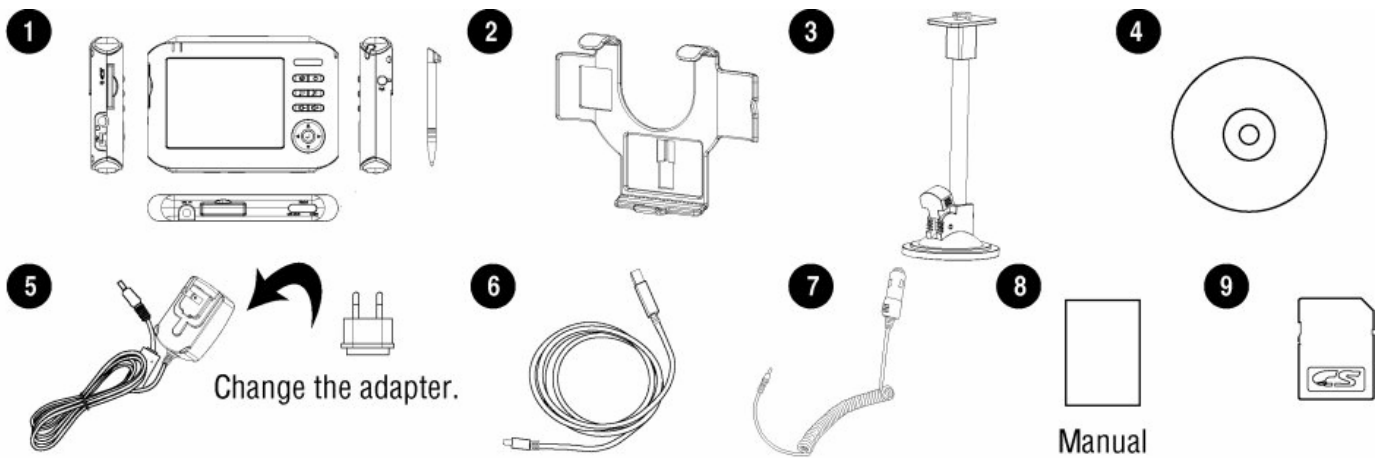

1. Your DPN-3500 w/Stylus touch pen
2. DPN-3500 holder
3. Windshield dock
4. CD-ROM
5. AC adaptor
6. USB cable
7. Car charger
8. User manual
9. Memory card (SD card)

Your DPN-3500 keypad & layout: (Front)



Rear :

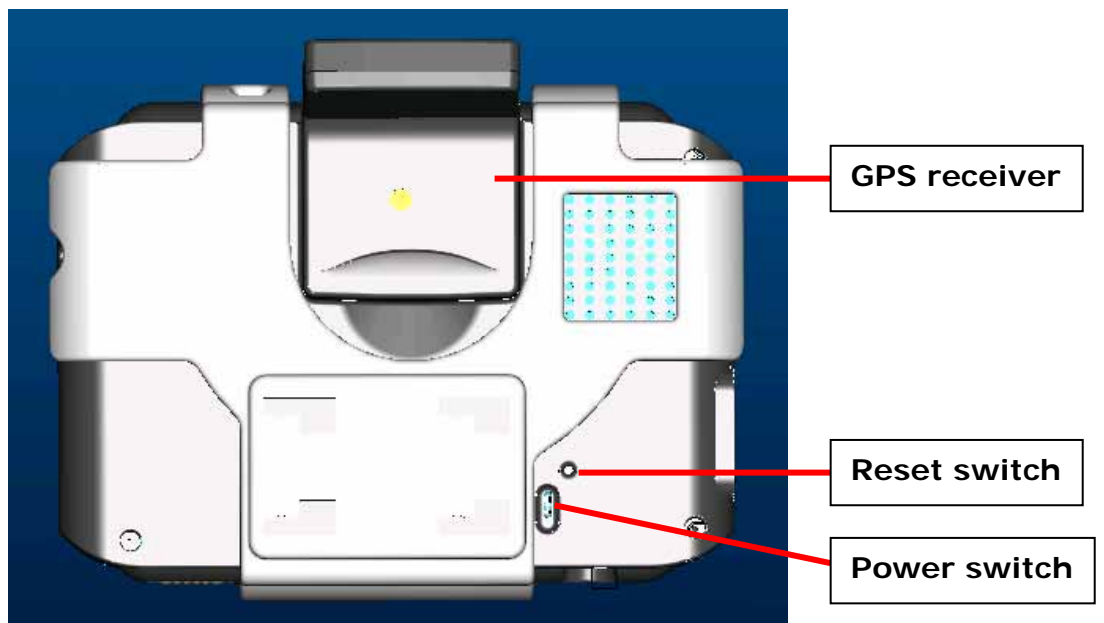

Top:

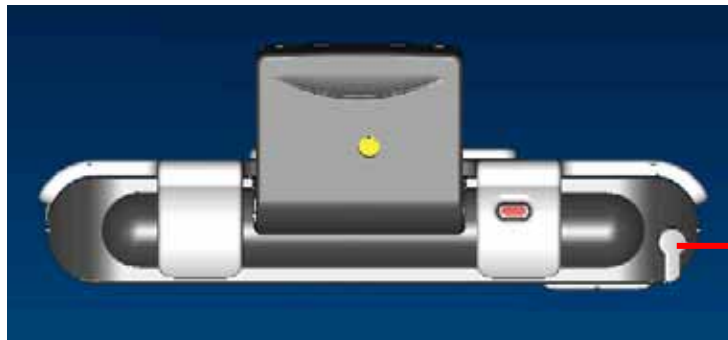

Stylus

Button:

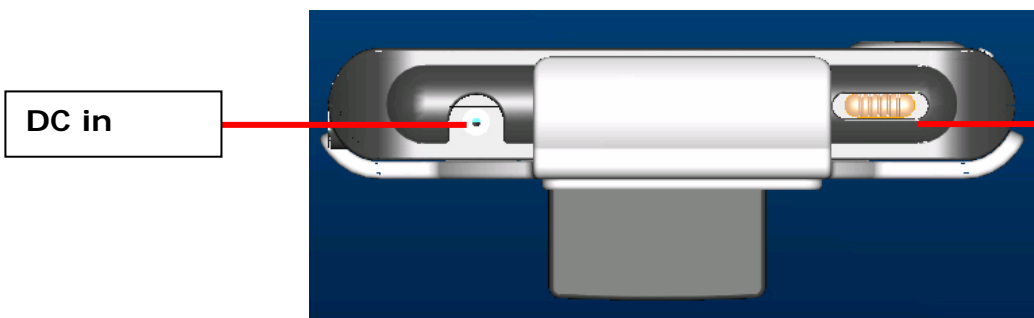

DC in

Hold key

Right:

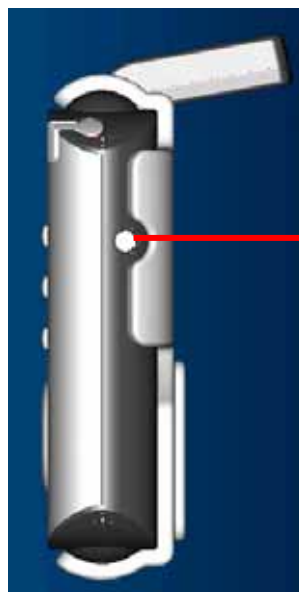

External Antenna

Left:

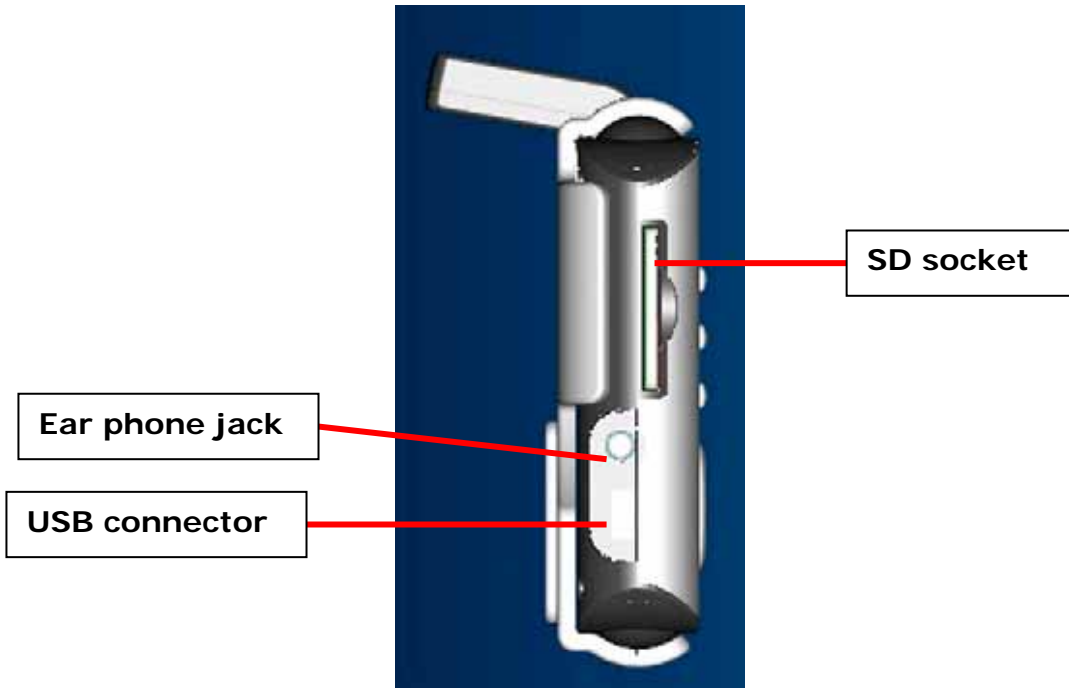

2 - Getting started

Full charge your DPN-3500 battery

We recommend you to get full complete charge your DPN-3500 when the first time you connect it to the home AC adapter. It takes 4 hours to complete charge the battery.

The battery indicator will be in RED when the battery of your DPN-3500 is low. Please be charge of battery.

When in charging, the battery indicator will be in flashing orange. After the full charge, the battery indicator will be colored in light orange.



Switching on

When the first time you get DPN-3500, please follow the instruction to switch your DPN-3500 on and set up the antenna as figure.

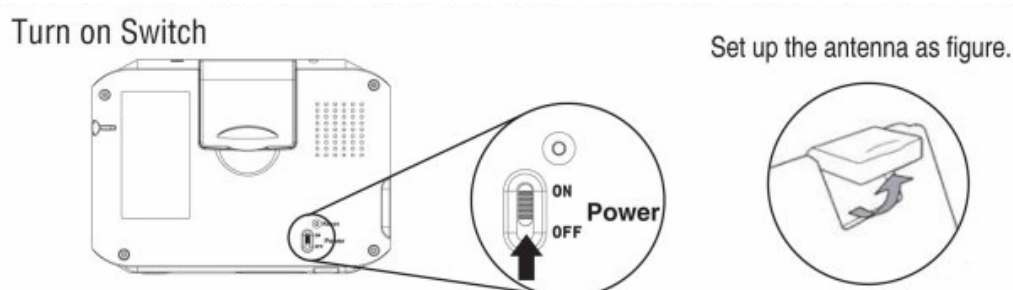

Calibration and Registration

Please follow the next few steps to do the calibration and registration by taping the screen.

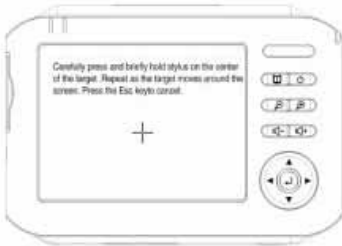

After charging, turn on the device. (Using the power button on the front, top right of it)

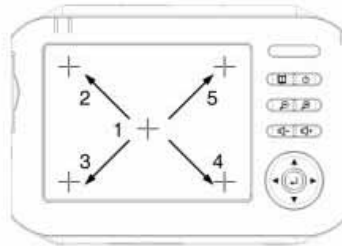

Please, with a stylus, press five targets "+" accordingly, then touch the screen again.



The here to set owner information.

Locating your current position

Please have your DPN-3500 to be outside to locate your current position. When you first start the navigation device, you will hear the message saying "signal is too low". It means the navigation has not located a reliable GPS signal yet. It will be up to 2 ~ 5 minutes to find your current position.

If after five minutes, the navigation is not located a reliable GPS signal, you need to check if you are in an open place without tall buildings or trees around you.

After GPS signal located the position, the GPS indicator will be in flashing GREEN.

GPS signal will be much faster and normally within a few seconds to find your position in the future after the first time use.

3 - Installing your device in a car

Please check the points as the follows when using Windshield Dock to install DPN-3500 in your car:

Use the windshield dock to place your DPN-3500 in your car.

Make sure your windshield is clean and dry before attaching the dock.

Place the dock in a place where it does not block your view of the road.

Attach the dock to an area of the windshield where the glass is flat, not curved.

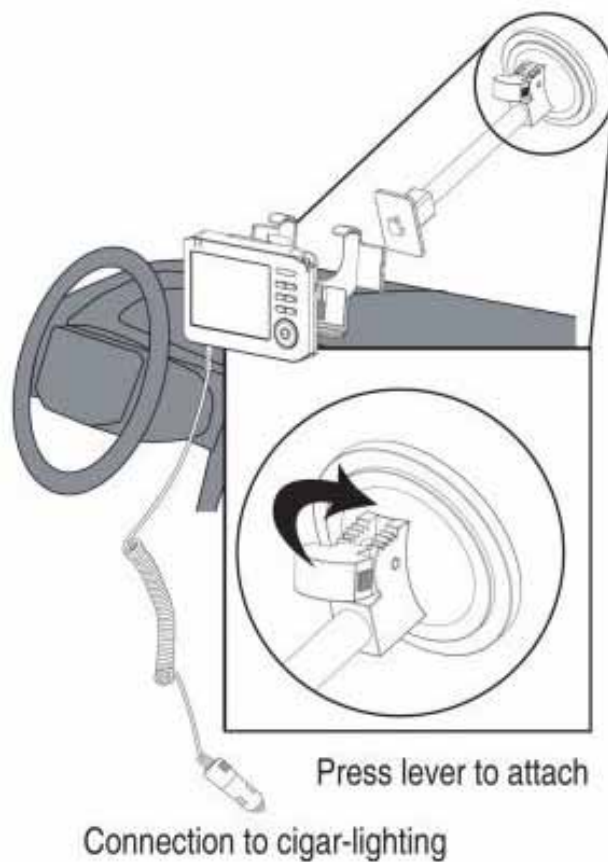

Travel TIP:

When on the road, the travel adapter turns the AC adapter into a portable charger / sync cradle.

4 - Connecting with computer (optional)

You can connect the DPN-3500 to your computer. Please also refer to the user manual for "installing the console' – DestinAtor portion".

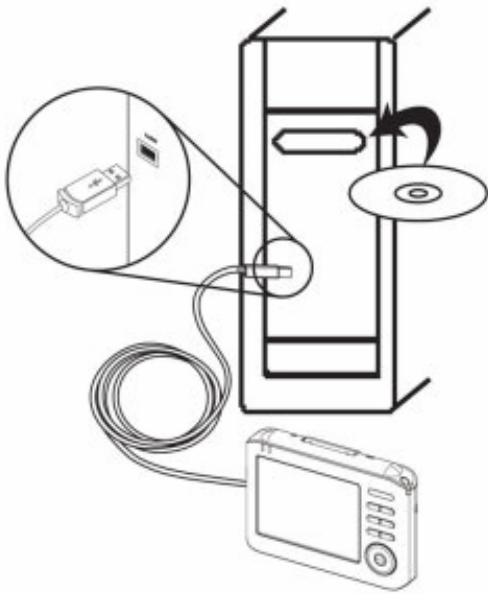

Insert CD into your computer drive.
Install Outlook and ActiveSync.
Insert USB cable into USB port.



With a stylus to push the tail of cover to open it,

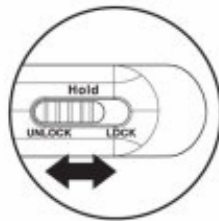

To keep the button bar on unlock side while starting the Navigation/key buttons executing.



Travel TIP:

When on the road, the travel adapter turns the AC adapter into a portable charger / sync cradle.

5 - Information for user

Important Safety Notices and Warnings

Global Positioning System

The Global Positioning System (GPS) is a satellite-based system that provides location and timing information around the globe. GPS is operated and controlled under the sole responsibility of the Government of the United States of America which is responsible for its availability and accuracy. Any changes in GPS availability and accuracy, or in environmental conditions, may impact the operation of your DPN-3500.

Use with car

Use of DPN-3500 for navigation means you need to drive with due care and attention.

Aircrafts and hospital

Use of devices with an antenna is prohibited on most aircraft, in many hospitals and in many others locations. DPN-3500 must not be used in these environments.

Full charging your DPN-3500

Please refer to the 'getting started' in this user manual on page 6 when first time you use the DPN-3500.

When driving a car, please always connect to cigar-lighting the DPN-3500.

Caring Your DPN-3500

Your DPN-3500 contains sensitive electronic components that can be permanently damaged if exposed to excessive shock or vibration. To minimize the risk of damage to your DPN-3500, avoid dropping your unit and operation it in high shock/vibration environments.

Protecting Your DPN-3500

Follow the cautions below to protect your DPN-3500 from damage:

Do not store the DPN-3500 where prolonged exposure to extreme temperatures can occur (such as in the trunk of a car), as permanent damage may result.

Do not expose the DPN-3500 to water. Contact with water can cause this unit to malfunction.

Do not leave your DPN-3500 in plain sight when you leave your vehicle. Take your unit with you or remove it from view to avoid theft.

Upgrade the map

If you have other questions about map upgrade, please contact your supplier or Destinator Technical Support via email at support-eu@destinatortechnologies.com or +44 (0) 871 075 5110.

Notice

Please have your license key number ready when ask for customer service.

6 - Troubleshooting

Here are some of the questions you may need to ask. For more questions and answer, see <http://www.daewoo-electronics.it>

Resetting your DPN-3500

If your unit locks up, please use stylus pen to tip the reset switch which located in rear of DPN-3500; if this does not help, power your DPN-3500 off and power it on again.

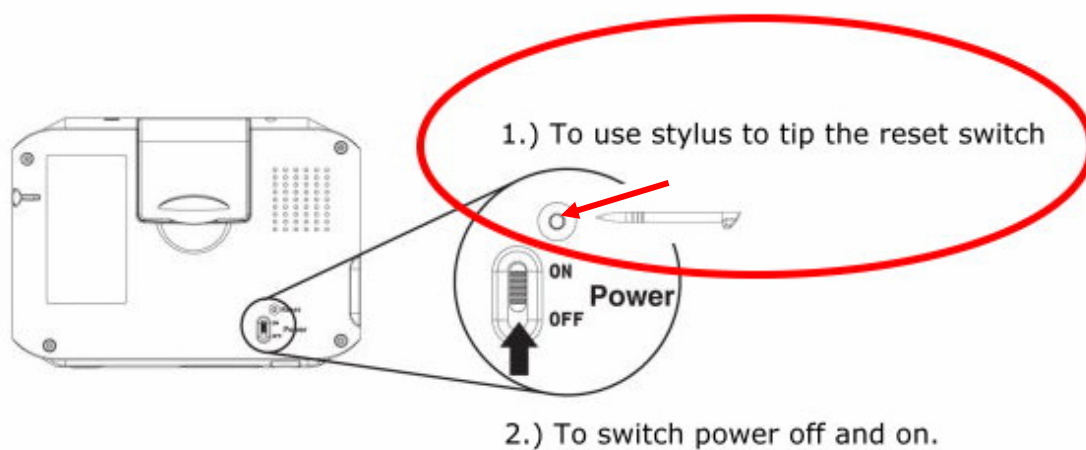

How to charge the unit?

DPN-3500 is normally charged whenever it is plugged into your car when using the supplied car charger, refer on page 8. You can use the AC adapter, as page 6 stated.

How do I get support?

Visit <http://www.daewoo-electronics.it> for technical support and contact information. Our preferred means of communication is by mail.

What do I do if I suspect the DPN3500 is defective?

If you have already tried to reset your DPN3500 and still experience a problem, please contact us by email on <http://www.daewoo-electronics.it>

What can I do if the car charger no longer seems to work?

Like all good automotive accessories, the car charger lead has a fuse, replace it with a standard fuse from an accessory shop.

DPN-3500 Technical Specification

CPU	Samsung 2410 266MHz
GPS	SiRF III or Compatible solution
Display	3.5" Landscape type, QVGA (320x240 pixels), with touch panel
Memory Flash/SDRAM	32MB NAND Flash, 64MB SDRAM
MAP Storage	SD/MMC
Button & Switch	Power, Hold, 5-way Joystick, Zoom in/out, Volume up/down
Audio	1W loudspeaker, stereo earphone output.
Power & Battery support	1350mA, 3.7V Li-Poly rechargeable battery. 5V 2A AC adapter and car charger.
PC Interface	USB 1.1 client for Active Sync.
O.S.	Microsoft WinCE.NET 4..2
Extension port	USB client, Earphone, External Active Antenna, SD Slot
Multimedia Ability (Optional)	MP3 playback, JPEG photo viewer
Operating	Temperature 0°C ~ 40°C, Humidity 40% ~ 80%
Dimension (PCBA)	112*73*18 mm (W*H*D)

Disposal of Used Electrical & Electronic Equipment

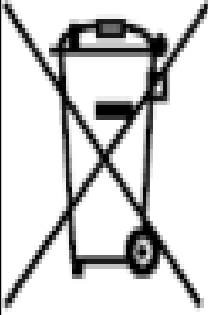

The meaning of the symbol on the product, its accessory or packaging indicates that this product shall not be treated as household waste. Please, dispose of this equipment at your applicable collection point for the recycling of electrical & electronic equipments waste. In the European Union and Other European countries which there are separate collection systems for used electrical and electronic product. By ensuring the correct disposal of this product, you will help prevent potentially hazardous to the environment and to human health, which could otherwise be caused by unsuitable waste handling of this product. The recycling of materials will help conserve natural resources. Please do not therefore dispose of your old electrical and electronic equipment with your household waste. For more detailed information about recycling of this product, please contact your local city office, your household waste disposal service or the shop where you purchased the product.



Destinator ND User Manual

Destinator Technologies

Notices, Disclaimers, and Terms of Use

1. Limited Product Warranty Destinator Technologies. warrants to the Client that the Products shall substantially conform to Destinator Technologies' specification for a period of one (1) year from the date of the original purchase by the end user (the "Warranty Period"). As Destinator Technologies' sole obligation and Client's exclusive remedy for any breach of warranty, Destinator Technologies agrees, at its sole option, to (i) use reasonable efforts to repair the Product with new or refurbished replacement parts; (ii) replace the Product with a new or refurbished unit; or (iii) refund the purchase price, provided Client returns the defective Products to Destinator Technologies with proof of purchase and Destinator Technologies' authorization.

Destinator Technologies' warranty hereunder does not apply in case of any damage caused by accident, abuse, misuse, misapplication, or alteration of any kind performed by anyone other than Destinator Technologies. The Products are not designed or licensed for use in mission-critical applications, or in hazardous environments, requiring fail-safe controls, including without limitation operation of nuclear facilities, aircraft navigation or communication systems, air traffic control, or life support or weapons systems. Without limiting the generality of the foregoing, Destinator Technologies specifically disclaims any express or implied warranty or condition of fitness for such purposes. Destinator Technologies' warranty does not, in any event, apply to physical damage to the surface of the Product or replacement. Destinator Technologies shall have no obligation with respect to any data stored in the Product.

Except as expressly stated in this section, Destinator Technologies makes no warranties or includes any conditions with respect to the products, express or implied, including, but not limited to, the implied warranties or conditions of merchantability, fitness for a particular purpose and no infringement.

2. Liability Limitation. In no event shall Destinator Technologies, be liable to Client, (and Client hereby waives any indirect, special, incidental, or consequential damages in connection with) the transactions contemplated by this agreement, whether or not such damages were foreseen, or their likelihood disclosed. Destinator Technologies shall not be liable to Client or any third party claiming through Client, for any damages of any kind in excess of the amounts paid by Client under the terms of this agreement with respect to the products giving rise to such damages. Some jurisdictions do not allow the exclusion of or limitation on implied conditions, warranties or damages, thus some of the foregoing may not apply to Client.

3. Intellectual Property Rights. Hardware and Software are proprietary to Destinator Technologies or its suppliers and are subject to copyright and other intellectual property laws. Client's only rights with respect to any Destinator Technologies software included with the Products shall be provided, under the terms of Destinator Technologies' software license. The title to all Destinator Technologies Software remains with Destinator Technologies. Client agrees that Destinator Technologies retains ownership of all rights, title and interest in all intellectual property; works of authorship, trade secrets and like's in all aspects of the Product(s). Client and its affiliates and subcontractors agree not to reverse engineer any aspect of the Software and/or Products supplied under this agreement and further agree to pay assessed damages should such action take place.

4. Copyright and Copies. The Software (including any copy thereof) is owned by Destinator Technologies or its suppliers and is protected by United States, Canada, European, Brazilian and Australian copyright and patent laws and international treaty provisions. The Software copy is licensed to you the client, not sold to you, and you (the client) are not an owner of any copy thereof. You may make one copy of the software for backup or archival purposes. You may not otherwise copy the software, except as authorized by applicable law, nor the written materials accompanying the Software. Destinator Technologies hereby reserves all rights not explicitly granted in this license agreement.

Copyright © 2006, Destinator Technologies

Contents

1 - Introduction	3
Destinator ND Features	3
Tutorial	3
2 - Getting Started	4
What's on the Map?	4
GPS Not Found	5
Map Views	5
Point on the Map	6
Menus	7
Screen Buttons	9
Cycling through Screens	10
3 - Search for a Location	11
Enter Address	11
Recent Locations	14
My Favorites	15
POI (Points of Interest)	18
Route Overview or Cancel Route	20
Turn-by-Turn List	21
Select Map	22
4 - Plan a Trip	23
Multistop Planner	23
Avoid Roads	25
Route Playback	27
Pedestrian Mode	28
Map Browsing	28
5 - Settings	29
Map	29
Quick Navigation	30
GPS Settings	30
Prompts	31
Units of Measure	32
Language Settings	32
Help	32
6 - Installation Requirements	33
PC Requirements	33
Installing the Console	33
Console Toolbar	33
Technical Support	34
7 - Maps	35
Map Screen Interface	35
Installing a Map	35
Map Cutter Screen Interface	36
Focus the Map	37
Cut Map	38
Load Map	38
Remove Map	39
8 - Importing a Favorite	40

9 - System Settings	42
Volume Settings.....	43
Power Settings	43
Backlight Settings	43
Date-Time Settings.....	44
Language Settings.....	44
System Information	44
Index	45

1 - Introduction

Welcome to the world of mobile navigation! Your **Destinator** device provides a full-featured mobile satellite navigation system. Gone are the days of “taking out the map”. You can now select an address or a predefined point of interest and request your navigation device to create a route.

Destinator ND Features

Destinator provides the following features for easy navigation:

- Lets you differentiate between car and pedestrian navigation
- Able to install and use your navigation device in minutes
- Full screen 2D/3D day and night maps with precise voice guidance
- Able to quickly create a route for any distance
- Cross border navigation without switching maps
- Intuitive menus and touch-screen buttons for easy input
- Instant address retrieval from recent locations, favorite destinations, or POIs
- Planning routes that include stopovers
- Avoid toll roads, congested roads, or roads through dangerous areas
- Provides traffic messages alerts (Optional)
- A wide selection of maps from all over the world
- A choice of over 10 languages
- Attractive map and screen format
- Totally portable, and can be used in a vehicle or by a pedestrian, during your daily commute or on vacation

Tutorial



From the **Settings** menu, you can tap the **Tutorial** button to open the **Destinator Guide Tour** program. The Guided Tour is an excellent way of becoming familiar with the different navigation features available.

2 - Getting Started

What's on the Map?

When you first turn on **Destinator**, the **Main Map** screen appears. You can use the icons displayed on this screen to plan and view your route.



Figure 1 - Map Screen



Your current location in **Vehicle Mode**.



Your current location in **Pedestrian Mode**.



Your last known location when **GPS** signal is unreliable.



The generated route.





Your selected destination.

The Compass displays the travel direction.

Displays the **GPS** status.

The **red GPS** receiver  means that the navigation device has not yet located a reliable **GPS** signal.

The **green GPS** receiver  means that the navigation device has located a reliable **GPS** signal and that you are ready to navigate.

These icons display your power source, electricity  or battery . The battery appears as green, yellow, or red depending on whether the battery is recharged or weak.

The **GPS** bar is a toggle button that displays the remaining travel distance and travel time, estimated time of arrival, and speed and altitude, and street name and address number.

When you have calculated a route, the **Directions** bar displays information about your next turn. Click this bar for a complete list of turn-by-turn directions.

GPS Not Found

When you first start your navigation device, you will hear the message “Signal too low”. This message means that your navigation device hasn’t yet located a reliable **GPS** signal. Check that your device is connected and has a clear view of the sky. If after five minutes, you have not located a reliable signal, go to the “Technical Support” section on page 34.

Please check that:

- The **GPS** antenna is extended or flipped up.
- The device has a clear view of the sky for uninterrupted **GPS** reception. **Destinator** cannot calculate the route if there is no **GPS** reception (for example, in a tunnel).
- The navigation device is charged or connected to the cigarette lighter.





Map Views

You can determine whether you want to see a two-dimensional or three-dimensional map in daylight or nighttime conditions.

The **2D Day Mode View** is optimized for a daytime viewing. 2D views let you manually pan or zoom. For an example, refer to *Figure 2 - 2D Day Mode Map View*.

The **2D Night Mode View** is optimized for night driving or adverse weather conditions. For an example, refer to *Figure 3 - 2D Night Mode Map View*.

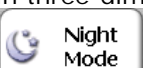
The **3D Mode Day View** or **Night View** provide you with a three-dimensional map for day or night driving. For an example, refer to *Figure 4 - 3D Day Mode Map View* and *Figure 5 - 3D Night Mode Map View*.

From the **Options** menu, click the **3D Mode**  button to view a three-dimensional map. If the map already appears in three-dimensions, **2D Mode**  is displayed on the toggle button. You can click the **Night Mode**  button to display the map in night conditions. If the map already appears in night mode, **Day Mode**  is displayed on the toggle button.

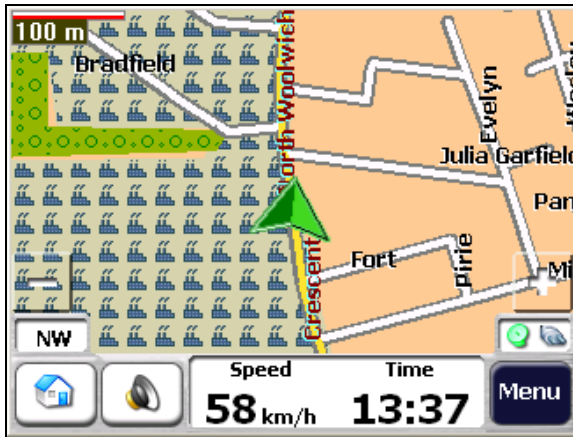

Figure 2 - 2D Day Mode Map View

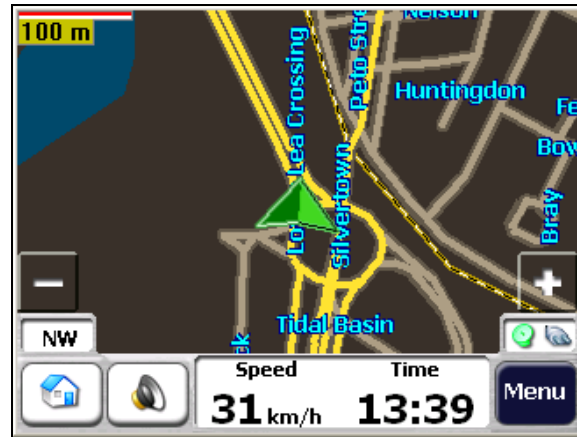

Figure 3 - 2D Night Mode Map View

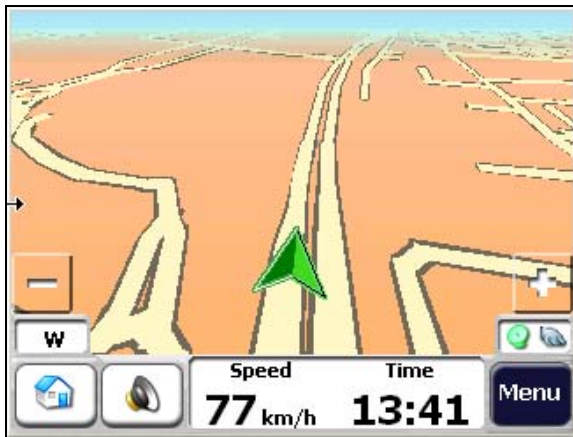

Figure 4 - 3D Day Mode Map View



Figure 5 - 3D Night Mode Map View

Point on the Map

You can navigate to any point by tapping its location directly on the **Map** screen. This feature is especially handy when you want to navigate to a specific point on the map, but you don't have the street address. When you tap on the map, the context menu appears.

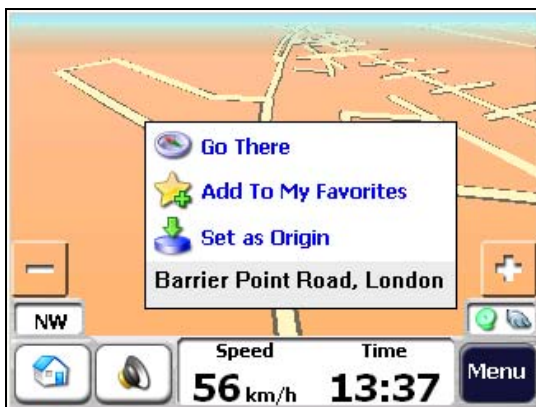

Figure 6 - Point on the Map Options

Navigate – This button lets you calculate a route from the map point.

Favorites – This button lets you save a point on the map as a favorite destination. This is helpful if you see a location that you want to return you later.

Set as Origin – This button lets you designate the selected point as the starting point and not the designation. This is helpful when you want to calculate a route from a point other than your current location.

Menus



You can press the **Menu** button from the **Main Map** screen to display the three main **Destinator** menus, as shown below.



Figure 7 - Destinator Menus



The **More** button lets you cycle through the **Destinator ND** menus.



You can click the **Map** button to return to the **Main Map** screen or the **Quit** button to close the **Destinator ND** Navigation System.

Destination Menu

This menu provides the following options:

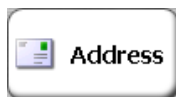

The **Enter Address** button lets you navigate to an address, as described in "Enter Address" on page 11.



The **Recent Locations** button lets you navigate to a previously visited destination, as described in "Recent Locations" on page 14.



The **My Favorites** button lets you navigate to a favorite location, as described in "My Favorites" on page 15.



The **Points of Interest** button lets you navigate to thousands of interesting places, such as beaches, parks, hotels, museums, and restaurants. For more information, see "Points of Interest" on page 18.



The **Route Overview** button lets you display your complete route on the **Map** screen. This button is disabled when no route exists.



The **Cancel Route** button stops the current navigation.



The **Turn-by-Turn** button lets you display the complete, step-by-step directions to your destination. For more information, see "Turn-by-Turn" on page 21.



The **Select Map** button lets you choose among different maps on your memory card. For more information, see "Select Map" on page 22.

Options Menu

This menu provides the following options:



The **Avoid Roads** button lets you avoid a road type, such as toll roads or selected streets, as described in "Avoid Roads" on page 25.



The **Multi-Stop Planner** button lets you designate several stops on a route, as described in "Multi-Stop Planner" on page 23.



The **Route Playback** button lets you record your route and play it back later. For more information, see "Route Playback" on page 27.

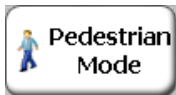

The **Walking Mode/Driving Mode** button lets you toggle between traveling as a pedestrian or in a vehicle. When in **Walking Mode**, the navigation region is limited to ten kilometers and **Voice** prompts are not available.



The **2D/3D Mode** toggle button lets you display the map view in 2-dimensional or 3-dimensional views for either day or night driving. For more information, see "Map Views" on page 5.



The **Day/Night Mode** toggle button lets you display the map view for either day or night driving. For more information, see "Map Views" on page 5.



The **Map Browsing** button lets you browse the map unconnected to the current location. In this mode, the **GPS** system is not used. Your current position is not detected and **Destinator ND** does not keep track of your driving progress.

Settings Menu

This menu provides the following options:



The **Look & Feel** button lets you select a skin, which determines the look and feel of the Destinator Navigation System.



The **Map Settings** button lets you specify map orientation, font, and zoom features. For more information, see "Map" on page 29.



The **Quick Nav Settings** button lets you specify an address or place to which you can navigate with a single tap on the **Quick Nav** button. For more information, see "Quick Navigation" on page 30.



The **GPS** button lets you configure the **GPS** settings. For more information, see "GPS Settings" on page 30.



The **Prompts** button lets you specify the types of voice or visual prompts that you want to use. For more information, see "Prompts" on page 31.

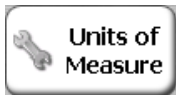

The **System** button lets you specify the system measurement units and provides About information. For more information, see "Units of Measure" on page 32.

Screen Buttons

The following buttons appear on many of the navigation **Destinator** screens.



When you tap the **Next** button for a selected address, group, or place, **Destinator** automatically opens the next screen in the sequence. After you have specified your destination, tap the **Next** button to display a map screen showing your selected location. This map lets you determine a route type and provides a **GO** button, which instructs **Destinator** to calculate the route from your current location to your selected destination.



When you tap the **Back** button, **Destinator** returns you to the previous screen.



When you tap the **GO** button, **Destinator** calculates the route to your selected destination.



The **Actions** button provides a list of command options available for the selected address or place.



The **Hide/Display Keyboard** toggle button lets you show or remove the keyboard.



The **Save**, **OK**, or **Done** buttons confirm your value preferences and returns you to the menu or map.

Cycling through Screens

Every navigation function in the system, such as Address, POI, or My Favorites consists of a sequence of screens. You can cycle through the screen sequences by either:

- Selecting an item from the list and tapping it.
- Selecting an item from the list and tapping the **Next** button.

The sequence ends with the **Show on Map** screen, where the destination is displayed and the **GO** button is available for you to calculate a route.

You must first select an item from the list to cycle through the screen sequence, and for the **Actions**, **Next** and **Back** buttons to be enabled.

3 - Search for a Location

Enter Address

When you click the **Address** button, the **Address** screen appears, as shown below.

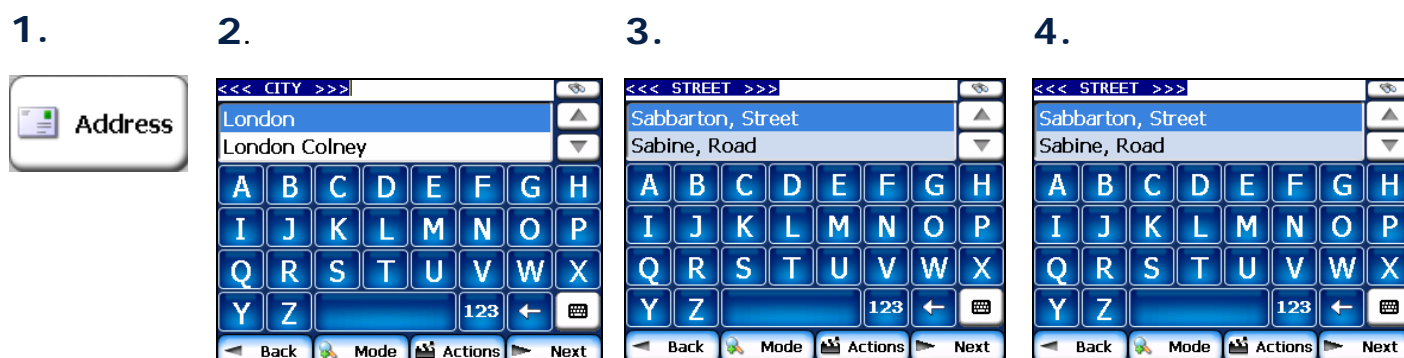

Figure 8 - Display the Address Screen

You can use the keyboard to enter the first characters of the address name. The characters appear in the **Address** field. **Destinator** automatically searches the **Address** list for the first occurrence of the entered characters. After you have selected a city, **Destinator** displays the next address field, such as street and address number.

You can also tap the **Next** button to move through the sequence of address screens.

The following command keys are available to enhance your search process:



If the automatic search feature does not find your specified name, use the **Find** button to conduct a sub-search, particularly useful when the address name consists of two or more words.



The **Scroll** buttons let you move up or down the list of address items, such as city or street names.



The **Hide/Display Keyboard** toggle button lets you extend or shorten the address list by hiding or displaying the keyboard.



The **Select** key lets you display lowercase and numeric characters.



The **Erase** key lets you delete the last character in an address field.

You can change your address search method by tapping the **Mode** button to select from a variety of address formats, as described in "Address Modes".

Note: If the entered characters are not found at the beginning of the name in the Address list, the Smart Search System automatically searches for the entered characters throughout the entire list, for example, in the middle or the end of the name.

Destinator lets you search for city and street names without having to enter accent marks (umlauts), which are used in many European languages.

Address Modes

You can define the information used to locate an address by tapping the **Mode** button. **Destinator** provides a variety of address formats, as described below.

City-Street This sequence displays the following address screens: **City, Street, Address Number**

You can also navigate to city or street only. When you have selected a city, the first entry of the **Street Name** list is **City Center**. When you have selected a street, the first entry in the **Address Number** list is **Street Midpoint**.

City-Street is the default format.

Street-City This sequence displays the following address screens: **Street, City, Address Number**

Lets you enter a street name without having to first designate a city. Useful when you're looking for an address in a metropolitan area where there are many cities and towns.

Cross-Street This sequence displays the following address screens: **City, Street 1, Street 2**

Lets you locate an intersection by entering the names of two intersecting streets.

Zip Code This sequence displays the following address screens: **Zip Code, Street, Address Number**

This mode lets you locate a street address by entering the zip code, without entering a city name. Useful when you have no city information or if the city has multiple zip codes.

In Other Maps

You can select another map of a country that you can travel to by vehicle.

This feature is available only when you have the following maps installed:

- Another map of countries on the same continent as the selected map
- The map of the major roads for the continent that connects one map to another (for example, the major roads of Europe)

For example, if you are in Paris and you want to travel to Munich, select the map of Germany and designate Munich City Center as your destination. **Destinator** automatically displays the map of France when traveling on local roads of that country, a map of Major Roads of Europe when traveling on a European highway, and the map of Germany when traveling on local roads of that country.

Address Actions

When you have specified an address, tap the **Actions** button to select from the following commands:

Set as Origin

Lets you designate the selected address as the route origin. Use this command when calculating a route from a point other than your current location. The navigation device displays the selected location as a starting point only for a few seconds before returning you to your current location. **Note:** You are still receiving the **GPS** signal.

Show on Map

Lets you see the selected address on the map.

Add to My Favorites

Lets you add an address to your list of favorite locations, as shown in the figure below. For more information, see "My Favorites" on page 20.



Figure 9 - Add Address to My Favorites

Information

Displays the location's address information.

Go to your Destination

After you have specified the address, tap the **Next** button. **Destinator** shows your destination on the **Map** screen before calculating a route. Check that the destination address is correct at the top of the screen. If you want to change the destination, tap the **Back** button and change your address entries.

1.



2.



3.



Figure 10 - Calculate your Destination

If the destination is correct, you can instruct **Destinator** how to calculate your route by tapping either the **Faster** or **Shorter** button, as described below.



This option selects the route that takes less time. **Faster** is the default value.



This option selects the route that is the shorter distance. Remember, the shorter route may not always be the quickest, as you are able to travel faster on some roads than on others.

Note: Route generation does not take into account any detours, stops, or delays along the route.

When you are ready, tap the **GO** button to create a route to your selected destination.

Recent Locations

The **Recent Locations** screen lets you select an existing destination from a list of destinations that you have previously traveled to. **Destinator** automatically stores the last 64 destinations in memory. As each new route is added to the top of the list, the older destinations at the bottom are erased.

To navigate to a recently-traveled destination, tap the **Recent Locations** button. From the **Recent Locations** screen, select a location and tap the **Show** or **Next** button. A map appears showing the specified location. Tap the **GO** button to calculate the route.

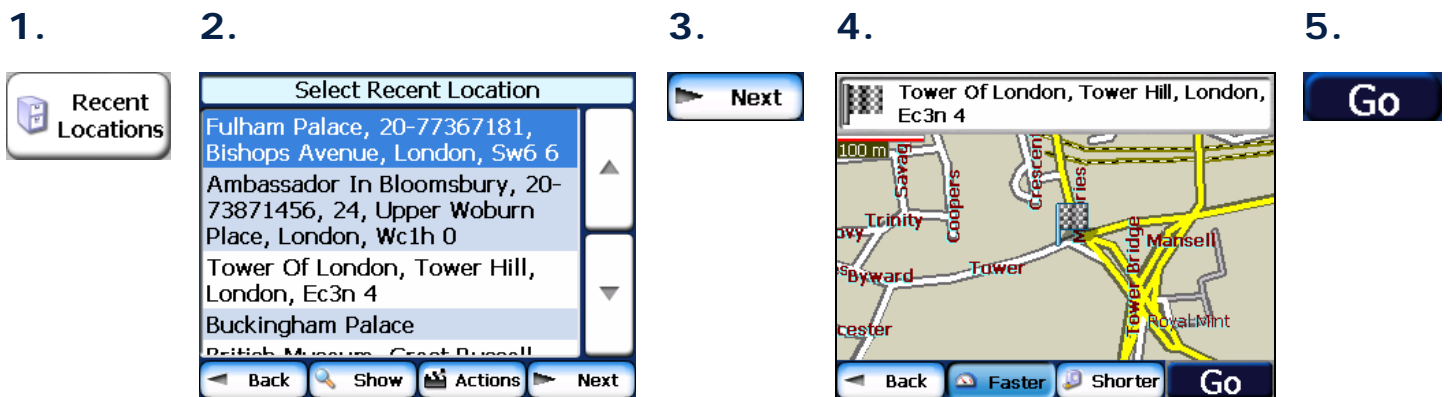

Figure 11 -Traveling to a Recent Location

From this screen, you can tap the **Actions** button to select from the following commands.

- Set as Origin** Lets you designate the selected address as the route origin. You would use this command when calculating a route from a point other than your current location
Note: You are still receiving the **GPS** signal.
- Add to My Favorites** Lets you add an address to your list of favorite locations. For more information, see "My Favorites" on page 20.
- Delete Item** Lets you delete a recent location.
- Clear List** Lets you clear all locations in the **Recent Locations** screen.
- Information** Displays the location's address information.

My Favorites

A Favorite is a destination that you have stored for easy retrieval.

To access a favorite destination, open the **Destinations** menu and tap the **My Favorites** button. The **My Favorites** screen displays your favorites groups. When you tap on a selected group, **Destinator** automatically displays its stored locations. Tap the selected location to show your destination on a map. Tap **GO** to calculate your route.

1.



2.



3.



4.



5.

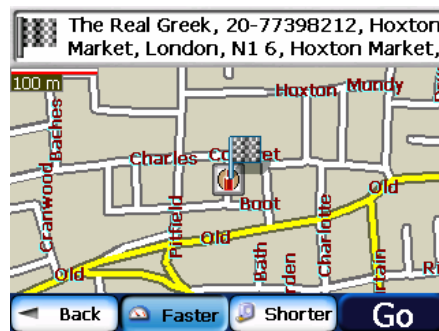

6.



Figure 12 - Travel to a Favorite Location

Note: The **My Favorites** folder is the default folder where all favorites are stored if not assigned to a group.

The **Show Map** screen also lets you set your route type, **Faster** or **Shorter**. For more information, see "Go to your Destination" on page 13.

Favorite Groups

You can tap the **Actions** button from the **My Favorites** screen to add, edit, or delete groups, as described below.

Add Group

When you tap this button, the **Favorites Group** screen appears. Enter the group name and select an icon to identify the group, as shown below.

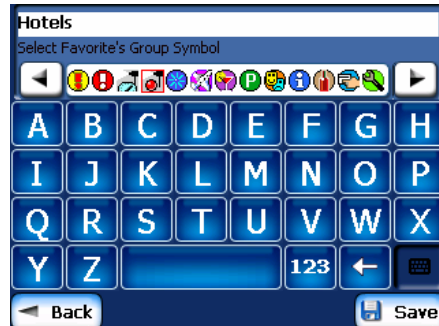

Figure 13 - Create Favorites Group

The icon identifies all destinations located in that group, as displayed on the map.

Edit Group

When you tap this button, the **Favorites Group** screen appears with the name and selected image of the highlighted group. You can change the name and icon.

Delete Group

When you tap this button, the selected group and its associated entries are removed. The **My Favorites** group cannot be deleted.

Favorite Alerts

Alerts let you know that you are within a certain distance of a favorite location.

You can tap the **Alerts** button to set the distances for the 1st and 2nd Alerts. When you travel closer than the designated distance, the alert will sound, as shown below.

- 1.
- 2.

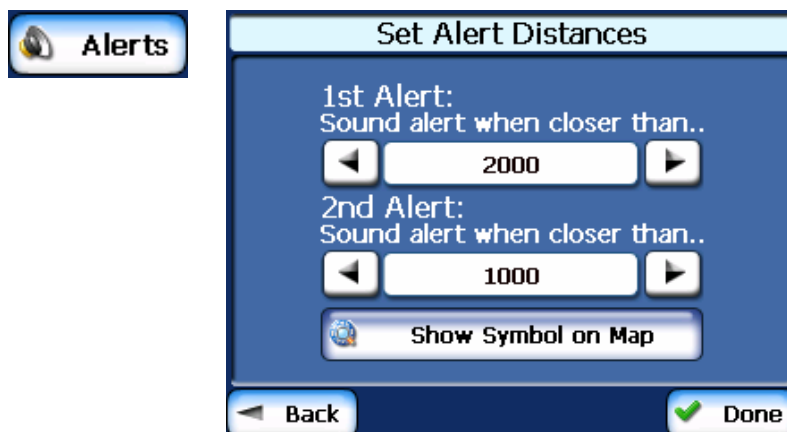

Figure 14 - Setting Your Favorite Alerts

Examples:

You have a group called "Shopping" that includes all of your favorite stores. An alert appears on the screen when you are closer than the designated distance to the stores in your group, providing an opportunity to consider whether you would like to stop and shop.

You have a group called "Projects" that include addresses of your bank, grocery store, garage, hardware store, doctor's office, post office, and so on. When the alert is set, **Destinator** reminds you about these places when you come within close proximity to them.

You are going on a trip and friends have recommended certain restaurants that are on your route. You can create a group called "Restaurants" and enter the restaurant addresses. As you take your trip, an alert will go off when you come within range of these restaurants.

Notes:

Favorite Alert settings affect all Favorites Groups.

The 2nd Alert must be set to go off at closer distance than the 1st Alert.

Alerts can be set for a group but not for individual locations. Of course, you can always create a group that has just one location.

You can disable the alerts for all groups by selecting the **1st Alert** setting to **Off**.

You can disable the alerts for a particular group by selecting the group and tapping the **Hide Symbol on Map** button. Disabled alerts are identified by a red diagonal line through the symbol.



Figure 15 - Disabled Favorite Alerts

Activate that disabled alert by selecting the group and tapping the **Show Symbol on Map** button.

Add Favorite Locations

Tap **MY FAVORITES** or any selected group that you have created to display its locations. You can save a location to your favorites groups from the **Address**, **Recent Locations**, or **POI** screens. For more information, see "Add to Favorites" on page 13.

From this screen, you can tap the **Actions** button to display the following commands.

Set as Origin

Lets you designate the selected location as the route origin. You would use this command when calculating a route from a point other than your current location. **Note:** You are still receiving the **GPS** signal.

Show Map

Lets you see the map with the selected favorite destination for you to review before creating a route.

Edit Favorite Location

Lets you change the name, comment, or group location for the selected location.

Delete Favorite Location

Tap the button to remove the selected location.

Information

This button displays additional address information, such as address details, phone number, and other comments about your favorite location that you have entered.

POI (Points of Interest)

The **POI** list is a collection of hundreds of interesting or useful places organized by easy-to-find categories. For example, you can use **Destinator** to guide you to a mall, hotel, restaurant, or gas station.

From the **Destinations** menu, tap the **Points of Interest** button. The **POI** screen appears. You can find a category by tapping the **Hide/Display Keyboard**  button and entering text in the **POI Category** field. The Smart Search System automatically displays the POI categories that match the characters entered.

If you didn't find the category through the initial search you can also use the **Find**  button to do a sub-search, particularly useful when the category name consists of two or more words. You can always browse the **POI Category** list by using the Browse buttons.

When selecting a category, **Destinator** automatically displays the category entries and the distance each entry is from your current position. Select your entry and tap or click the **Next** button to display your selected destination on the map and then tap **GO** to calculate your route. From the **Show on Map** screen, you can designate a route type, **Faster** or **Shorter**. For more information about calculating a route, see "Go to your Destination" on page 13.

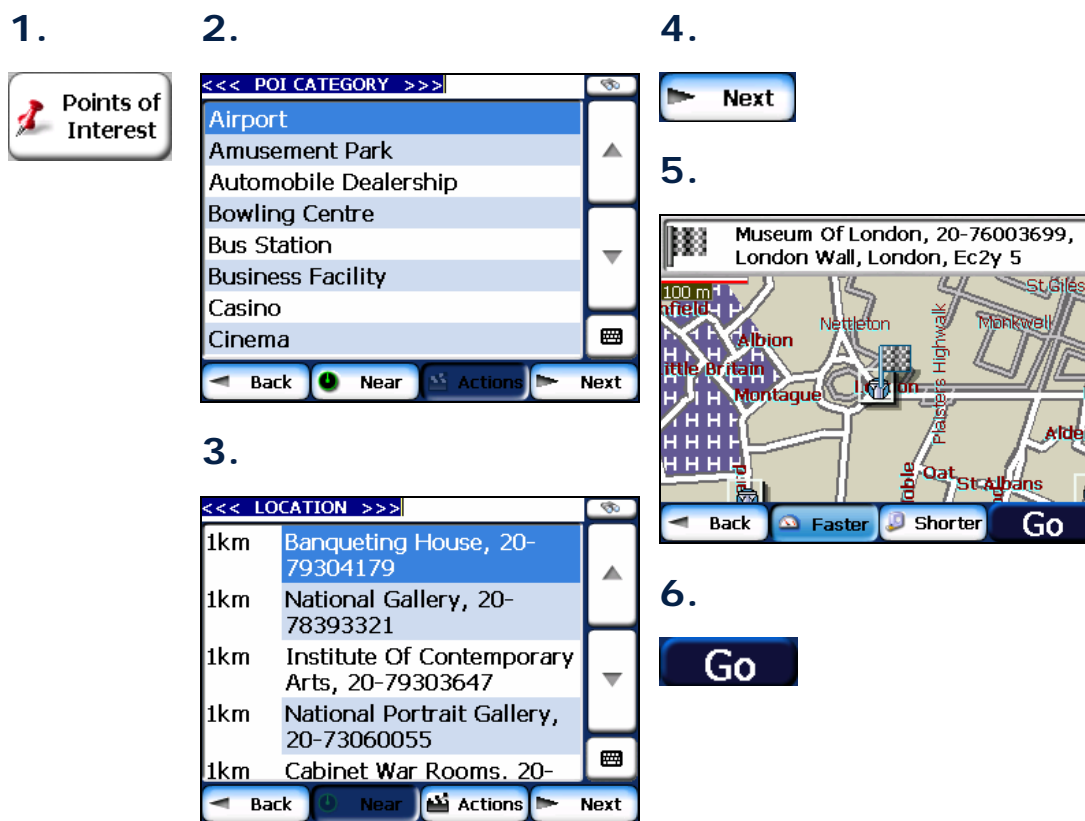

Figure 16 – Points of Interest

Note: From the **Item Entries Actions** screen, click the **Sort by ABC** button to display the category entries in alphabetical order.

Subcategories

Many categories have subcategories to provide for an even greater list of choices. For example, “Gasoline Station” may have many subcategories each representing a particular brand name. The same is also true for “Hotels”. “Restaurants” have subcategories that represent different types of food, such as American, Italian, and French, as shown below.

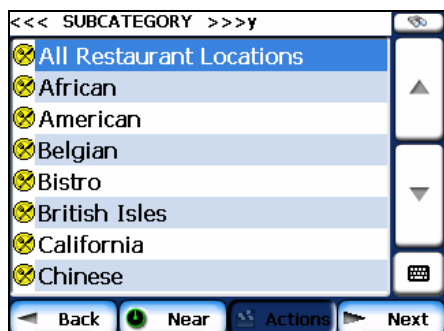

Figure 17 - POI Subcategories

Search Near a Location

You can tap the **Near** button to determine the location area, where you want to search for a specific place, such as a gas station, hotel, or restaurant.

The available options are listed below.

Current Location	Lets you search near your current location. This is the default value.
Destination	Lets you search near a specified destination. For example, you know your general destination, but not very much about interesting locations in the area. You can use Destinator to locate the tourist attractions most appealing to yourself, family, or friends. Note that this button is enabled only when a destination is entered.
Other Address	Lets you search near another address. For example, you have set a destination, but on the way you want to stop at another location. You can use this feature to search near that location for restaurants, lodging, historical sites, or anything you want.
Search Radius	<p>Enter the location distance to search for a designated place. For example, if you enter 5 km, Destinator only searches within a five kilometer radius.</p> <p>When you select a large search radius, you risk the chance of finding too many locations, which makes it harder to find the place that you are searching for. It is best to start with a small search radius size, and then make it larger if necessary.</p> <div style="background-color: #f0f0f0; padding: 5px; border: 1px solid #ccc;"> <p>Note: if you don't specify a search radius, Destinator searches the whole map.</p> </div>
Show or Hide Symbol on Map	Lets you customize your POI list by showing or hiding the POI category symbols that you don't want. When you hide a category a red mark appears. This mark only means that the category symbol does not appear on your map. The category locations are still available to you. You can always show a hidden category symbol by selecting the category and tapping the Show Symbol on Map button.

Actions

When you have selected a POI location, tap the **Actions** button to display the commands listed below.

Set as Origin

Lets you designate the selected location as the route origin. You would use this command when calculating a route from a point other than your current location.
Note: You are still receiving the **GPS** signal.

Show on Map

Lets you show the map with the displayed destination for you to review before creating a route.

Add to My Favorites

Lets you add a POI entry to your list of favorite locations. For more information, see "My Favorites" on page 20.

Sort By ABC or Distance

Lets you sort the entries of the selected category alphabetically or by distance from your current location.

Note: **Destinator** initially displays the entries by distance.

Information

Displays the telephone number and address information, and all other information the system has regarding the selected POI entry.

Route Overview or Cancel Route



The **Route Overview** button lets you display an overview of your complete route on the **Map** screen, the total driving distance to your destination, the estimated travel time, and the complete destination address.

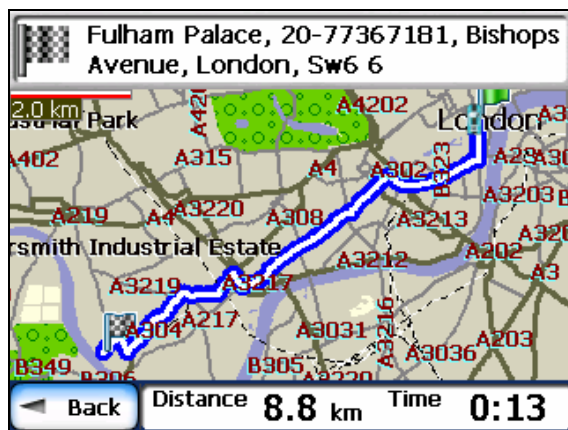

Figure 18 - Show Route



The **Cancel Route** button stops the current navigation and clears the route. This feature is active only after a destination has been set.

Turn-by-Turn List

After you have entered a destination and calculated a route, the **Directions** bar appears at the bottom of the **Map** screen, displaying the following information:

- The next turn direction
- The distance to the next turn
- The street name of the next turn

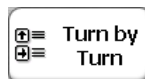

When you tap the **Directions** bar or click the **Turn-by-Turn** button, **Destinator** displays a complete set of turn-by-turn directions from your current point to your selected destination.

Use the Scroll buttons to move up or down the directions list.

1.



2.



Figure 19 - Display Turn-by-Turn

The following options are available:



The **Route Summary** button displays your entire route on the **Map** screen, plus the travel distance and the **Estimated Travel Time Remaining (ETR)**.



The **Show Turn** button displays the next turn on the **Map** screen, including the street name, the distance to it, and the turn direction.



The **Avoid** button lets you avoid the selected turn in the directions list. **Destinator** recalculates the route automatically. Note that when you exclude a turn, the recalculated route may take longer.

Select Map

This feature lets you change the currently selected map to another map saved on your SD memory card. If you want to store additional maps on your memory card, see “Maps” on page 35.

You can tap the **Select Map** button from the **Options** menu to display the maps saved on your SD memory card. The **Select Map** screen displays map details and version numbers. The map currently used appears at the top of the list.

1.



2.

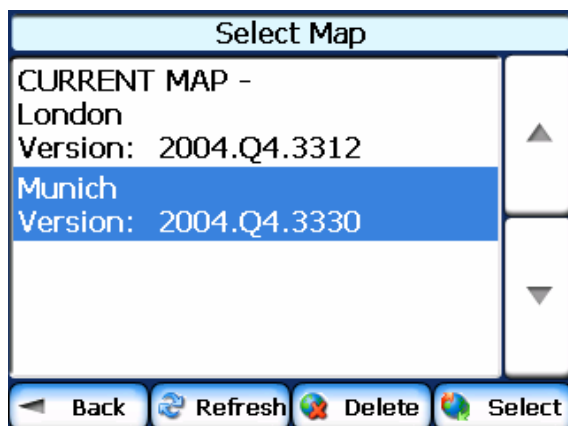

Figure 20 - Select a Map

The following **Select Map** commands are:

Select Lets you designate a selected map as the current map.

Delete Lets you permanently remove a selected map.

Note: You cannot delete the current map.

Refresh Lets you refresh the screen when a new memory card is inserted into the device.

4 - Plan a Trip

Multistop Planner

The **Multistop Planner** lets you plan a route with up to twelve stops.

When you press the **GO** button, the route is calculated in stages, from the departure point to the first stop. When you reach the first stop, the route recalculates to the second stop, and so on.

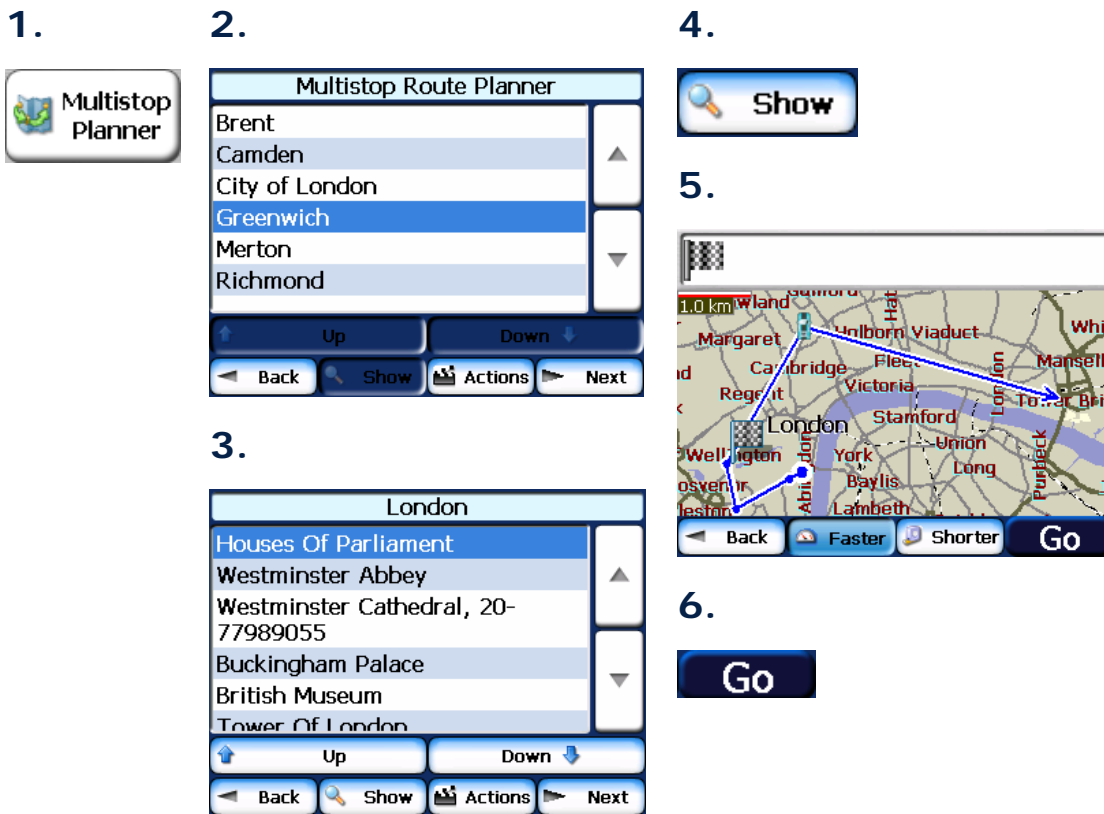

Figure 21 - Travel to Multiple Routes

The **Show on Map** screen provides you with the following route types: **Faster** and **Shorter**. You can select **Shorter** to calculate a route with the shorter physical distance between your current location and the selected designation. When you tap the **GO** button, **Destinator** automatically calculates the faster route.

Defining Route Groups

A **Route Group** represents a group of stops.

From the **Multistop Planner** screen, select the **Actions** button and tap **Add Group**. From the **Add Group** screen, enter the **Group** name and save. The **Actions** screen also lets you edit or delete a selected group.

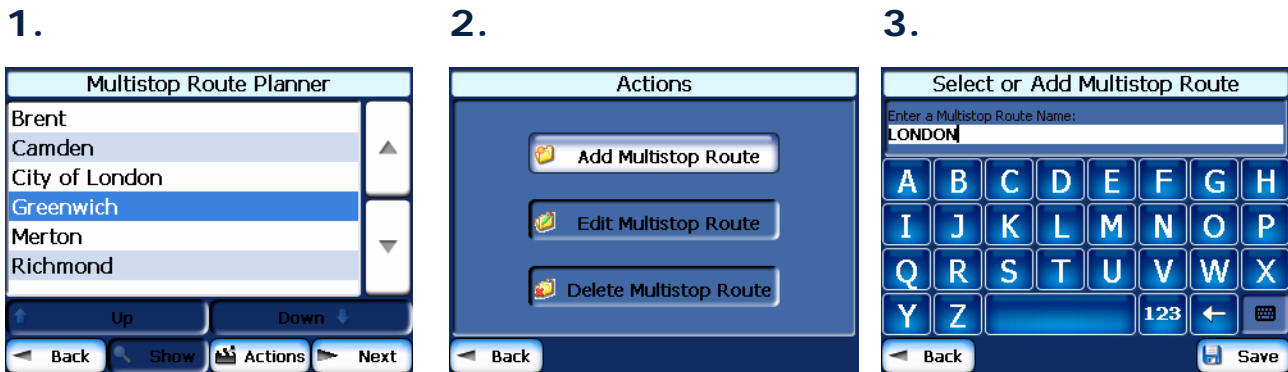

Figure 22 - Defining the Route Group

Setting Stops along the Route

You can set up stops by selecting the **Route Group** and tapping the **Next** button. From the **Stops** screen, tap the **Actions** button to add, rename, or delete a destination.

Add a stop by **Address**, **POI**, **My Favorites**, or **Recent Locations**. Select one of these options, specify a location, and click the **OK** button. The **Add Stop** screen appears. You can change the location name, enter a comment, or designate a different group. When you're done, tap **Save**.

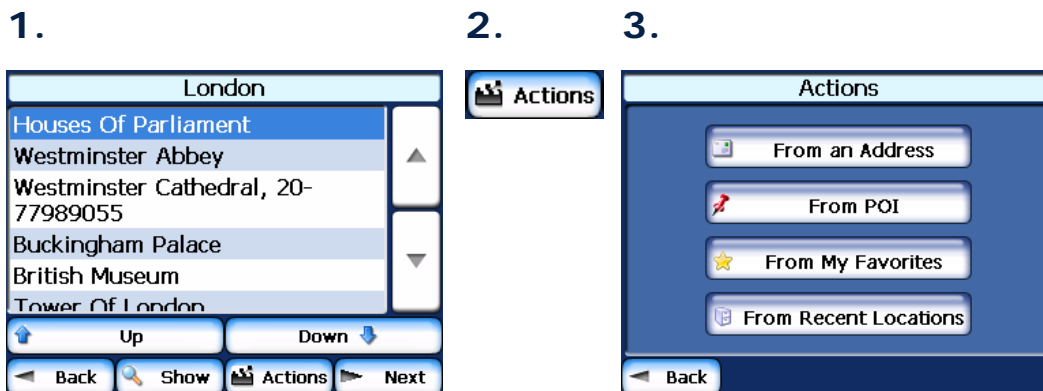





Figure 23 - Specifying a Stop

When in the **Stops** screen, you can use the following commands:

-  You can use the **Move Up** or **Move Down** buttons to change the order of your itinerary.
- 
-  Shows the stop destination on the map and lets you select a route type, **Faster** or **Shorter**. Tap **GO** to calculate the stop destination.
-  Select the **Show** button to view the selected stop destination on the map.

Stop Actions

You can tap the **Actions** button for the following command options:

- Set as Origin** Lets you designate the selected address as the route origin. You would use this command when calculating a route from a point other than your current location. **Note:** You are still connected to the **GPS** signal.
- Add Stop** Lets you add a location by specifying an address from recent locations, favorite locations, or pre-defined POIs, such as fuel, food, or lodging.
- Rename Stop** Lets you change the stop information, such as name, comments, or route group.
- Delete Stop** Lets you remove a selected stop.
- Optimize Route** Your trip itinerary is created by the sequence of stops entered. This may not be the most efficient route. When you click **Optimize Stops**, **Destinator** changes the order of **stops** to create the most efficient route.
- Information** This button displays the location's address information.

Avoid Roads

You can specify that certain roads be permanently excluded from your route calculations. Use this feature when you want to avoid congested boulevards, toll roads, or unsafe streets.

From the **Destinations** menu, tap the **Avoid Roads** button. The **Avoid Roads** screen appears, displaying the **Toll Roads** and **Avoid Road** groups.

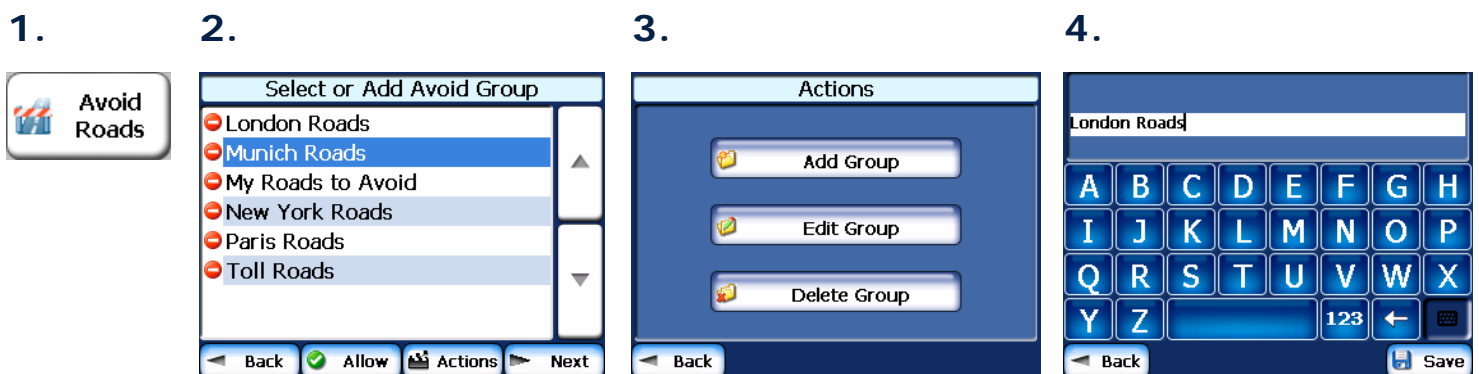

Figure 24 – Creating Avoid Road Groups

Avoid Road Groups

From the **Avoid Roads** screen, tap the **Actions** button. The **Actions** screen lets you select from the following commands:

- Add Group** Create a new a group of roads to avoid. For example, you can create a group called “San Francisco Roads”, where you designate the roads in that area to be avoided.
When you tap the **Add Group** button, the **Avoid Roads Group** screen appears. Enter the group name and tap **Save**.
- Edit Group** Select a group and tap this button to change the group name. When you tap the **Edit Group** button, the **Avoid Roads Group** screen appears displaying the group name. Change the group name and tap **Save**. The new name is displayed on the **Avoid Roads** screen.

Delete Group Select a group and tap this button to remove the group from the **Avoid Roads** screen. The road entries in this group are also removed.

When selecting a group route, you can tap the **Allow**  or **Avoid**  button to include or exclude all roads located in the group.

Avoid Road Locations

When you tap **Default** or an **Avoid Roads** group, **Destinator** displays the group screen, which lets you select roads to avoid. From this screen, you can use the **Allow** or **Avoid** buttons to include or exclude a selected road when calculating a route.

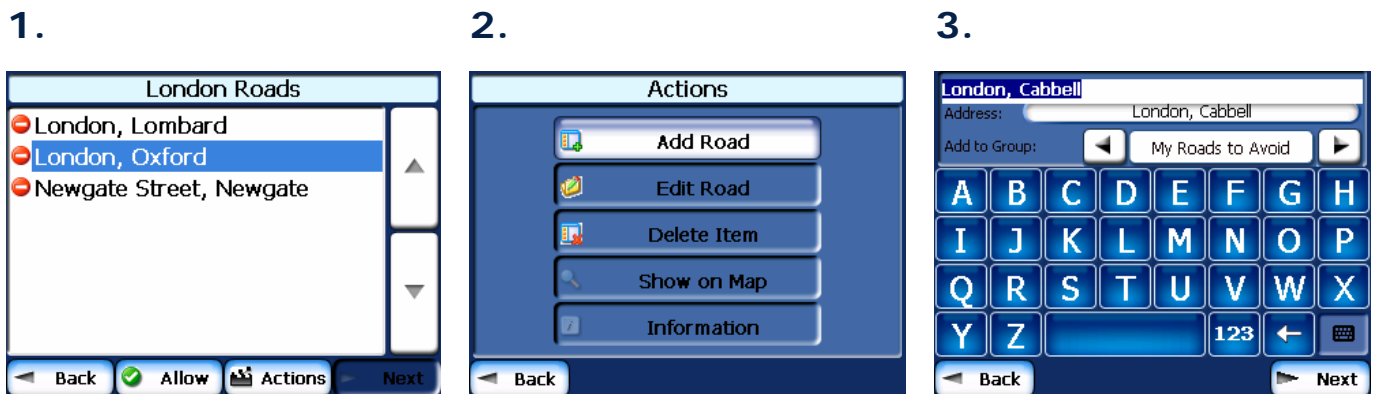

Figure 25 - Adding a Road to Avoid

Note: You cannot specify a particular toll road.

You can tap the **Actions** button from this screen to select from the following commands:

- Add Road** Lets you select a road. An address screen appears for you to specify a city and street. When you have completed updating your road information, tap **Save**.
- Edit Road** Lets you rename the road and select a different group. When you have made your changes, tap **Save**.
- Delete Road** Select a road and tap this button to remove the road from your group. **Destinator** no longer recognizes the removed entry as a road to avoid.
- Show on Map** Lets you show the map with the displayed destination for you to review before creating a route.
- Information** This button displays the location's address information.

Route Playback

This feature lets you record your route as you're traveling and then to play it back on the **Map** screen. From the **Options** menu, tap the **Route Playback** button.

To record a route, tap the **Record** button in the **Route Playback** screen. **Destinator ND** shows the **Map** screen and navigates you to your selected destination. To stop recording, return to the **Route Playback** screen and tap the **Stop** button.

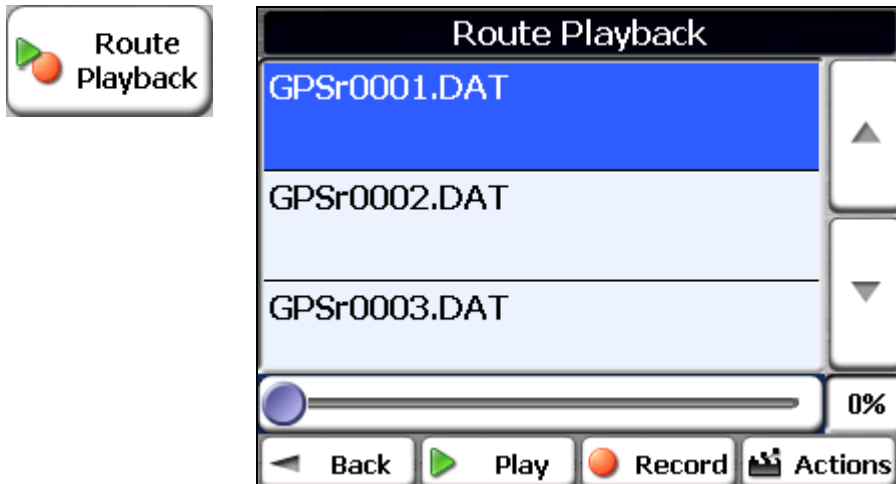

Figure 26 - Recording a Route

To playback your recording, select the data file, and tap the **Play** button. **Destinator ND** shows the **Map** screen to play the recorded route. To stop the playback, return to the **Route Playback** screen and tap the **Stop** button.

You can tap the **Actions** button to display the following commands:

- | | |
|-----------------------------|--|
| Delete Recording | This button lets you remove a selected recording. |
| Clear All Recordings | This button removes all recordings. |
| Playback Speed | Use the arrow keys to adjust the playback speed. The range is from 100% to 300%. |

Pedestrian Mode



The Pedestrian Mode button lets you toggle between traveling as a pedestrian or in a vehicle. When in Pedestrian Mode, your navigation region is limited to ten kilometers. When creating a pedestrian route, Destinator avoids highways or other roads where pedestrians would not travel. Voice prompts are not available in this mode.

Pedestrian Mode displays a shadow that shows the position of the sun. This is helpful when you are trying to orient yourself to the Map screen during the day. For example, you have calculated a route, but you don't know whether the route is to the right or left of your current position. If your shadow is behind you, then the sun is in front of you. Move your navigation device to the direction of the sun and follow the route. At night, no shadow is displayed.

Note: The sun is always in the opposite direction from where your shadow appears.

Map Browsing



This feature lets you browse the map without the **GPS** receiver returning you to your current location. Tap the **Browse the Map** button to disconnect from the **GPS** receiver.

5 - Settings

Map

You can click the **Map Settings** button from the **Settings** menu to customize your map display, as shown in the figure below.

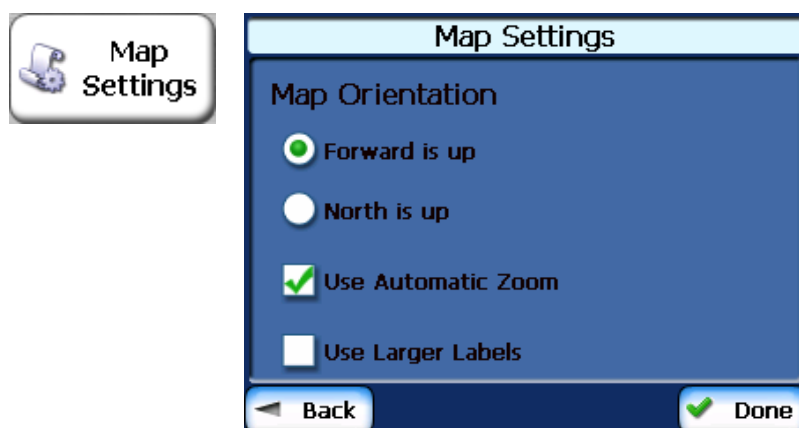

Figure 27 - Map Settings

The following map settings are:

Map Orientation

Forward is up – This option orients the map so that your forward direction is always at the top.

North is up – This option orients the map so that North is always at the top.

Use Automatic Zoom

When this option is selected, the zoom is speed dependent. The map zooms out at higher speeds, displaying a larger map area, and zooms in at slower speeds, displaying a smaller map area. If you manually change the zoom, the Automatic Zoom returns to its system level after several seconds of inactivity.

Use Larger Print

This option increases the size of street names to make the map easier to read.

Quick Navigation

You can define the **Quick Nav.** location by selecting either the **To Predefined Address** or **To Nearest POI Category** in the **Quick Nav. Settings** screen. When the location is selected, you can navigate to your address

by tapping the **Quick Nav.**  button displayed on the **Map** screen.

For example, if you have selected "Gas Stations" as the **Quick Nav.** destination, when you click the **Quick Nav.** from the **Map** screen, **Destinator** automatically creates a route to the closest gas station.

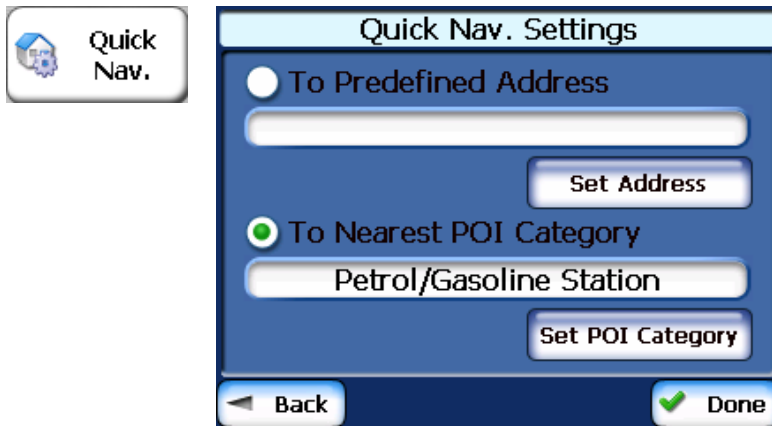

Figure 28 - Setting the Quick Nav Location

GPS Settings

Destinator ND uses the **GPS** receiver to pinpoint your location. **GPS** signals are automatically acquired and your vehicle's location and position are constantly updated unless you are working in the **Browse Map** mode. The **GPS** may take a few minutes to find its initial location. For best results, ensure that the **GPS** has a clear view of the sky.

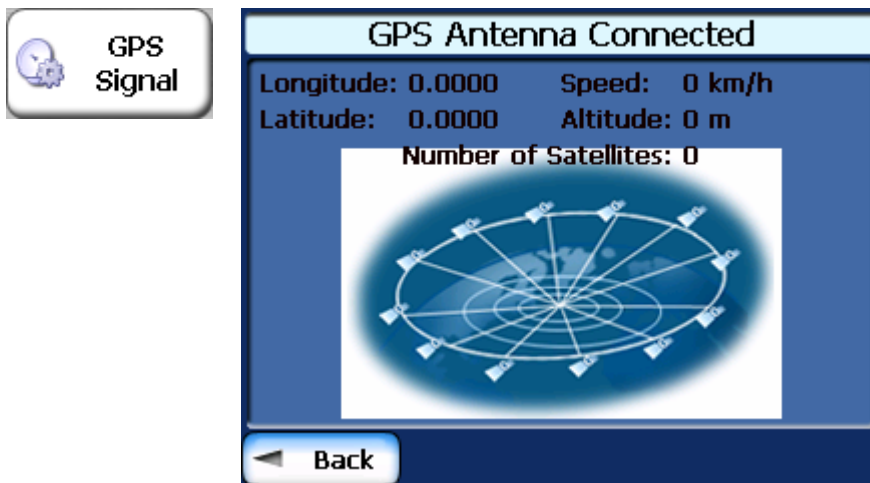

Figure 29 - GPS Status

You can tap the **GPS Status** button from the **Settings** menu to display the following information:

- Longitude - The angular distance east or west on the earth's surface, as measured in degrees from the meridian of a particular point to the prime meridian of Greenwich, England.
- Latitude - The angular distance, measured north or south from the equator, of a point on the earth's surface.
- Speed - The rate of movement, as expressed by kilometers or miles per hour.
- Altitude - The height above sea level.

The green lines that appear on the satellite image represent the satellites that are sending **GPS** signals to your receiver.

Prompts

You can select the types of voice and visual notifications that you would like to use while navigating. From the **Settings** menu, tap the **Prompts** button. The **Prompts** screen appears, as shown in the figure below.

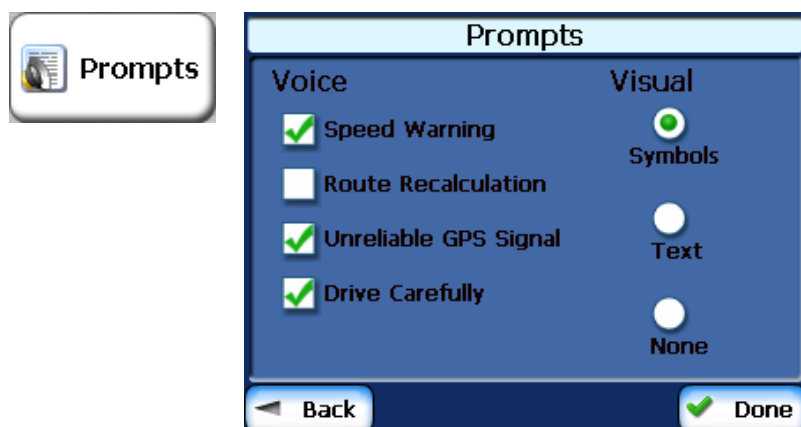

Figure 30 - Prompts Settings

Voice Prompts

Speed Warning

This prompt warns you when your car exceeds the speed limit. This prompt is not active unless selected.

Route Recalculation

This prompt is activated when **Destinator** recalculates a new route. This prompt is not active unless selected.

Unreliable GPS Signal

This prompt warns that the **GPS** signal is too low and unreliable for navigation. This prompt is automatically active.

Drive Carefully

This is a friendly reminder at the start of each journey. This prompt is automatically active.

Visual Prompts

Text

Directional prompts are displayed in written form.

Symbols

Directional prompts are displayed in diagram form, such as an arrow.

None

Directional prompts are not displayed.

Units of Measure

From the **Settings** menu, click the **Units of Measure** button to specify the system's units of measurement.

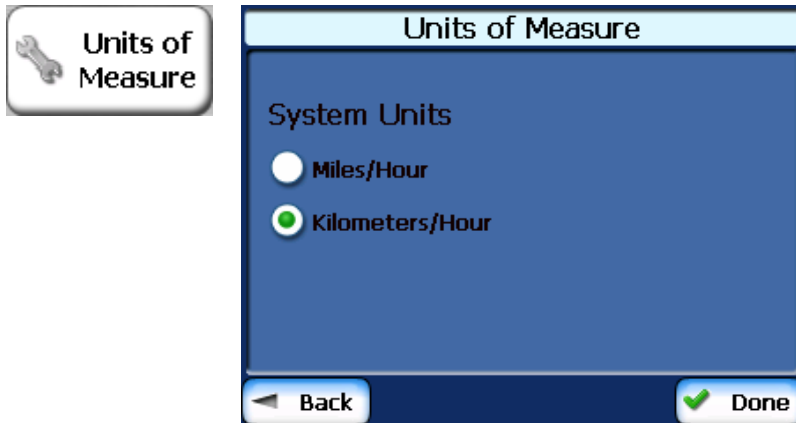

Figure 31 - Units of Measure

You can select:

System Units You can select:

Imperial – Yards or miles

Metric – Meters or kilometers

About

This information box provides version and copyright information.

Language Settings

This screen lets you select the language for announcing travel prompts, street names and driving directions. You can also select the type of voice, such as American, British, French, German, and so on.

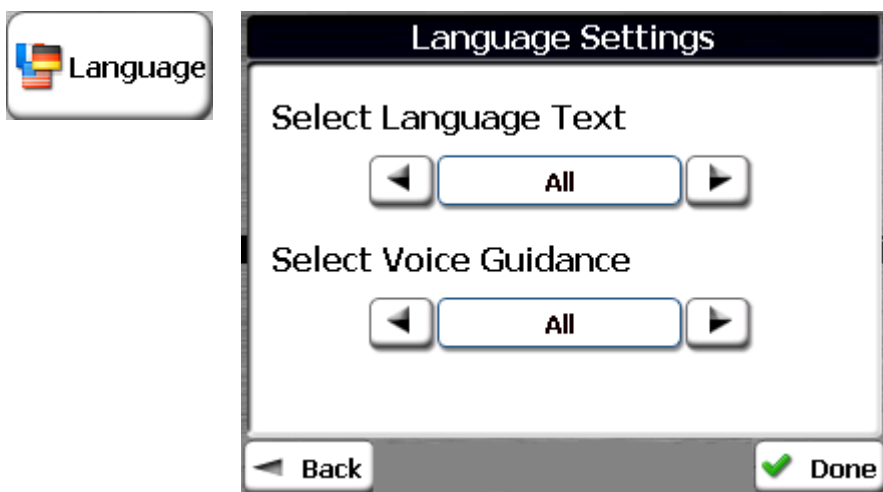

Help



The **Help** button displays the **Destinator ND** Help file.

6 - Installation Requirements

Destinator ND is already installed on your proprietary device, but to add or change maps, you are required to install the **Destinator ND Console** on to your PC.

PC Requirements

To install and use the Console, your PC must meet the following requirements.

- Microsoft Windows 98, ME, NT, 2000, or XP
- Microsoft ActiveSync
- A minimum of 300 MB free space for temporary files
- An Internet connection for online registration

Installing the Console

To install the **Destinator ND Console**:

- 1 Insert the **Destinator ND Disk** into the PC's CD-ROM drive. The **Destinator ND Console Installation Wizard** prompts you to select the language used for the installation process. When you have selected a language, click **OK**.
- 2 Please read the **Welcome** message and click **Next**.
- 3 From the **Select Directory** screen, either accept the recommended default directory or browse to a different directory to install the **Destinator ND Console**. Click **Next**.
- 4 From the **Language** screen, select the default language. Click **Next**.
- 5 The **Installation Confirmation** screen displays your installation choices. If you are ready to install, click **Next**. The **Installation Status** box displays the progress of the installation process.

If you want to change the language selection or the directory location before installing, click **Back**, make your changes, and return to the **Installation Confirmation** screen, and click **Next**.

- 6 When the installation is complete, click the **Finish** button to close the wizard.

Console Toolbar

The following options are available from the **Console Toolbar**:



The **Install Software** button lets you install the Navigation System to your device.



The **Install/Remove Map** button lets you install or remove a map. For more information, see "Installing a Map" on page 35.

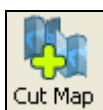

The **Map Cutter** button lets you customize an installed map. For more information, see "Map Cutter Screen Interface" on page 36.



Favorites Importer

The **Import Favorites** button lets you download a list of your favorite locations from your PC to the selected **My Favorites** group on your device.



Quick Activation

The **Quick Activation** button lets you activate your Navigation System through an automated process.



Destinator Backup

The **Backup** button allows you to save your **Favorites, Multi-Stops** or **My Destinator**. When you click on the **Save** button, the Favorites files, the MPR and the Destinator.ini file are copied into your drive: **[X]:\Destinatorapps\Backup [X]** represents the letter of the installation reader for Destinator on the user's PC. If these files already exist on the PC, the following message will appear: **Warning: A safeguard exists on this computer. Do you wish to override?**



Destinator Restore

The **Restore** button allows you to restore your **Favorites, Multi-stops** and **My Destinator**. When you click on the **Restore** button, the console recovers the information saved in the drive: **[X]:\Destinatorapps\Backup** and sends those files to the appropriate destinations on your machine. If an existing file already has the same name, the console will add the extension **<<old>>**.

Technical Support

Hotline: +49 (0)1805-123012

Fax: +49 (0)1805-008318

Web: support-eu@destinatortechnologies.com

7 - Maps

When you receive your device, **Destinator ND** is installed on your SD memory card along with a series of maps. This section provides information about installing additional maps from the **Destinator ND Console**. For information about installing the **Destinator ND Console**, see “Installation Requirements” on page 33.

Map Screen Interface

On the **Destinator ND Console**, a collection of maps is displayed.

Standard Maps Maps available for installation from your CD.

My Maps Maps that you have customized from a standard map. For example, creating a map of London from the standard map of the United Kingdom and Ireland.

Installed Maps Current maps on your SD memory card.

Installing a Map

You can install a map by selecting it from the **Standard Maps** pane in the **Destinator Console** and clicking the **Install/Remove Maps** button. The **Target Device** dialog box appears. Select **Storage Card**. The amount of memory available for the SD memory card appears on the **Target Device Memory Balance** pane. The installed map appears in the **Installed Maps** pane.

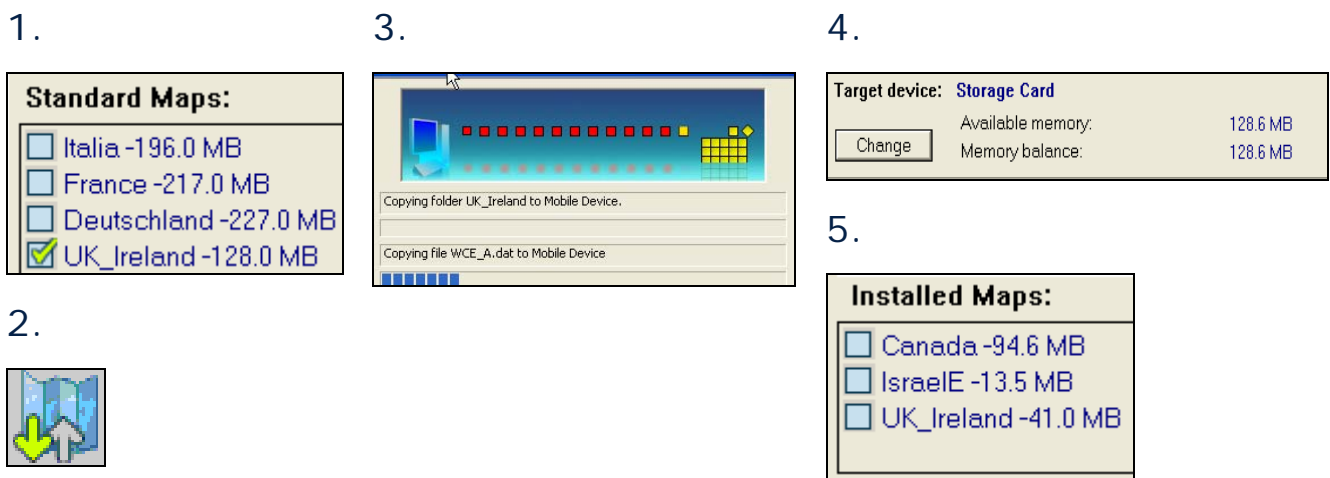



Figure 32 - Installing a Map

Map Cutter Screen Interface

Due to memory limitations of your SD memory card, you may want to customize a standard map by selecting the area you need. For example, if you are visiting a number of European cities on business, you may not want to install entire maps of those countries.

You can crop a standard map from the **Destinator Map Cutter** screen. Select a standard map and click the **Cut Map**  button. The **Map Cutter** screen appears, as shown in the figure below.

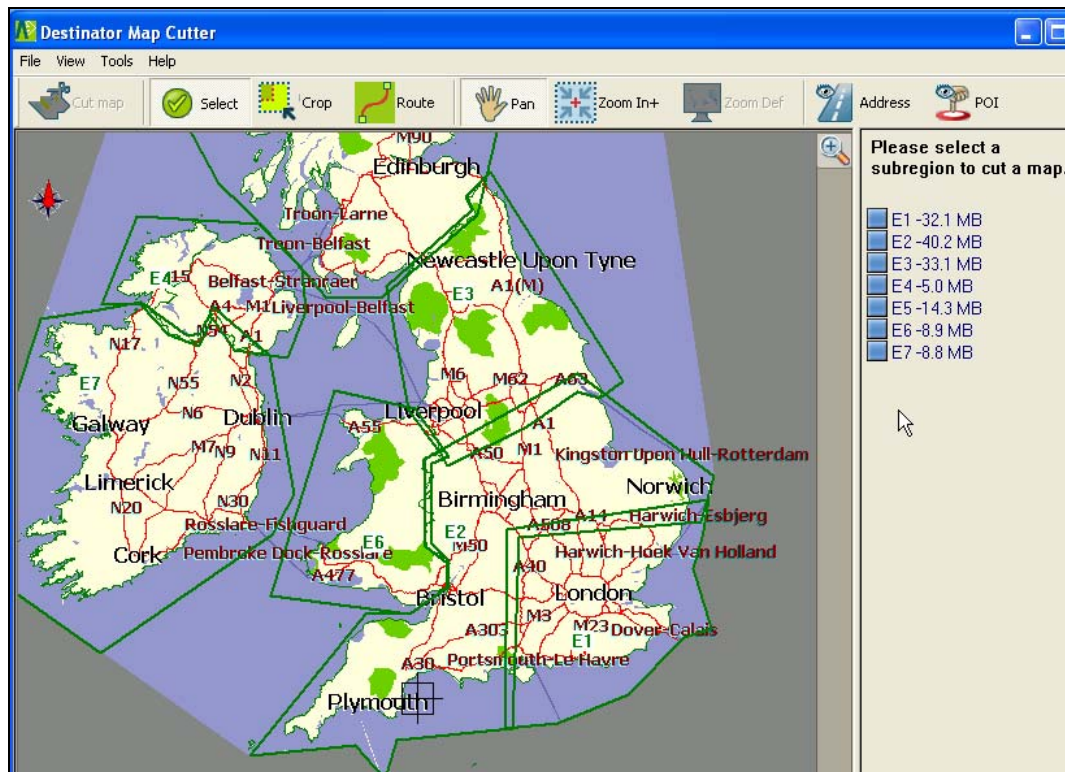

Figure 33 - Using the Map Cutter

The following tools are provided to help you easily move, view, and designate an area on the map:



You can use the **Pan** tool to move the map up, down, left, or right.



You can use the **Zoom** tool to increase or decrease the map detail. You can also use the scroll bar to zoom in or out.



You can use the **Crop** tool to designate an area on the map that you want to cut. When you have selected your focus by using the focus tools, as described below, click the **Crop** tool to designate an area on the standard map.



You can use the **Cut** tool to create a customized map from your designated area.

Focus the Map

The following tools are provided to help you center your map, so you can designate the area that you want to cut. For example, perhaps you want the Center of London to be the center of your map. If you are creating a very local map, perhaps you want to make the office or the hotel the center.



You can click the **Address** tool to set the origin of the map to a **City, Street Address, or Intersection**. The **Address** dialog box provides the **Show** and **Set** buttons to view and set the map focus.



You can click the **POI** tool to set the origin of the map to a point of interest. The **POI** dialog box displays all categories in the left pane. When you click a category, the items associated with the category appear in the right pane. You can click the **Show POI** and **Set POI** buttons to view and set the map focus.



You can click the **Select** tool to set the origin of the map by a predefined sub-region. A list of sub-regions is displayed in a pane to the right of the map. When you click a sub-region, that area is highlighted.

Focus the Map by Route

Destinator ND supports route cutting, which allows you to create a map composed of points on a route. To create the route, you must specify two or more points. After the route has been created, you can cut a map from your route specifications.

Click the **Route** tool. The **Route** pane appears. Use the **Address** and **POI** tools to set route points. Click the **Create Route** button. Your route is highlighted in blue. Click the **Cut Map** tool.

- 1.
2.

Point ...	Point's Name
	Belfast
	Tron (England)
	Glasgow
	Edinburgh
3.
 Corridor: 40 km
 Route: Quickest Shortest
- 4.
- 5.
- 6.

Figure 34 - Create Map by Route

The following commands are described below:



Click this button to center the map on the selected point.



Click this button to delete the selected point.



Click this button to delete all selected points.



Click these buttons to move a selected point up or down.



Corridor You can select the amount of surrounding area that is included along the route's path, as measured in kilometers or miles.

Route You can select either the quickest route, as determined by speed limit, or the shortest physical route.

Cut Map

When you have designated your map area, click the **Cut Map**  tool. The **Cut Map** dialog box appears, as shown in the figure below.

Figure 35 - Cutting a Map

You must enter a map name and description. If you have entered a name that already exists, **Destinator ND** prompts you to enter a different name.

You can click the **Estimate** button to display the map size. This is an important feature when memory space is limited.

Load Map

On the **Destinator Console**, you can refresh your maps by clicking **Tools>Refresh New Map Data**. Select the map that you wish to load by clicking on the map image or select it from the list. A checkmark represents a selected map.

From the **Target Device** pane, click the **Change** button to specify where to install the map. You can choose Removable Disk. After you have selected your target device and have confirmed that there's sufficient memory, click the **Install/Remove Maps** button. Your selected maps are installed and appear in the **Installed Maps** pane.

Remove Map

In the **Target Device** pane, click the **Change** button and select the location from where to remove the map. You can choose **Storage Card**. This updates the **Installed Map** pane.

The **Installed Map** pane displays a list of all the loaded maps available. Select the check box by the map you want to remove. Click the **Install/Remove Maps** button to remove the selected map.

8 - Importing a Favorite

You can download a list of favorite locations from your PC to your device.

The list must be contained in **.csv** files. As part of the download procedure, you convert the **.csv** files to **.dat** format for storage on your device by using the **Destinator Conversion** utility.

Favorites Importing File Structure

The Favorites Importing file structure must be in **.csv** (Comma-Separated Values) format.

The file contains the following fields:

1. Name of favorite
2. Comment
3. Longitude
4. Latitude
5. ZIP Code
6. City
7. Street
8. House number

The Longitude and Latitude are numerical values. All the others are string values. If a string value contains a comma, the field must have quotation marks.

Examples:

Name	Comment	Long.	Lat.	Zip Code	City	Street	House Number
Favorite place 1	Destinator Favorites Converter Comment 1	39.21370	38.78903	8033	Munich	Ariboweg	173
Favorite place 2	Destinator Favorites Converter Comment 2	24.85091	34.33012	1070	Brussels	Moutstraat "Weg"	183
Favorite place 3	Destinator Favorites Converter Comment 3	44.80999	38.16141	1096	Amsterdam	Joop Geesinkweg	9003
Favorite place 4	Destinator Favorites Converter Comment 4	24.79360	37.08604	75010	Paris	Rue Danton	3013
Favorite place 5	Destinator Favorites Converter Comment 5	44.97889	23.82718	8044	Zurich	Frits Weg	123

The **.csv** file contains the values in a table as a series of ASCII text lines, organized so that each column value is separated by a comma from the next column's value and each row starts a new line.

Importing a .CSV File

To import a **.csv** file:

On the Destinator Console, click on a **Standard Map**. This will enable the Installing Map and Favorites Importer features.

- 1 Click the **Favorites Importer** button. The **Converter** dialog is displayed.
- 2 Select the **.csv** file, specify a category name, and click the **Convert** button. The **Report Area** displays a message stating that the content of the file has been converted and that the file is ready for download.
- 3 Download the file to your device by clicking the **Download** button.

9 - System Settings



Starts the **Destinator ND** application

Opens the device's **System Settings** screen

Figure 36 - The Main Menu

You can change the system settings by tapping the **System** button. The **System** screen shows all of the system settings that you can change, as displayed below.



Figure 37 - System Settings

You can tap the **Back**  button to return to a previous screen.

Volume Settings

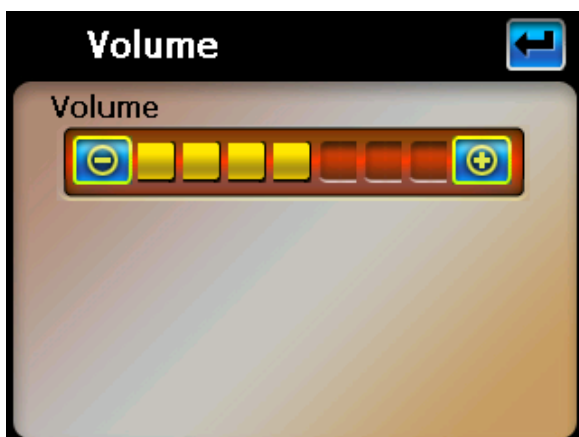

Figure 38 - Volume Settings

This screen lets you change the volume level for voice prompts and tap sounds.

Power Settings

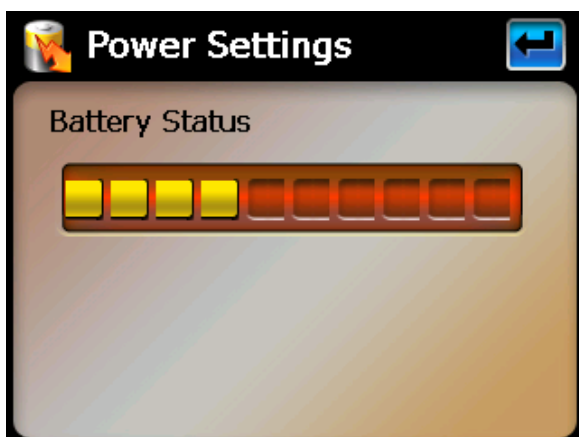

Figure 39 - Power Settings

This screen indicates the battery status of the device.

Backlight Settings

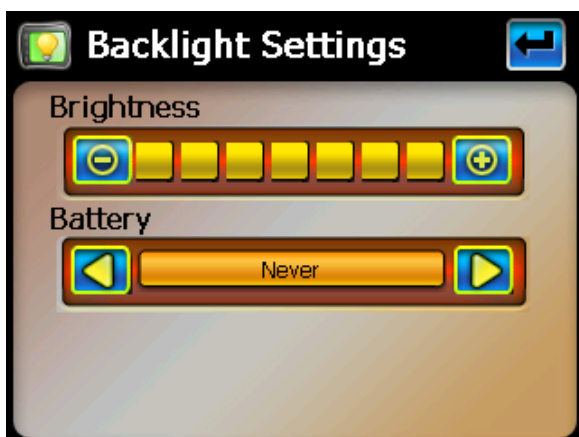

Figure 40 - Backlight Settings

This screen lets you determine the brightness of the screen. You can save power by selecting how long the backlight will stay on before it dims when running the device either on battery or on AC power.

Date-Time Settings

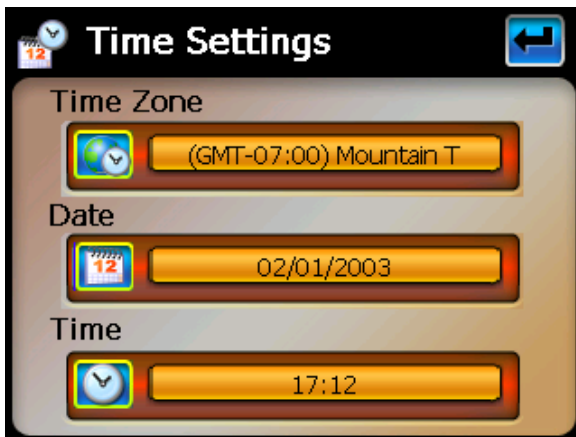

Figure 41 - Date-Time Settings

This screen lets you select your time zone, and to set the date and time.

Language Settings

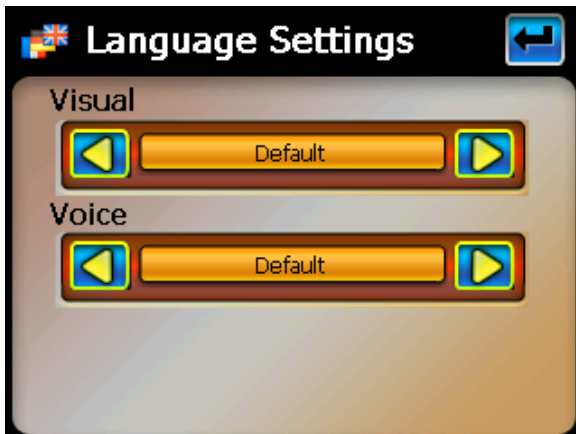

Figure 42 - Language Settings

This screen lets you select the language to be used for screen displays and voice prompts.

System Information

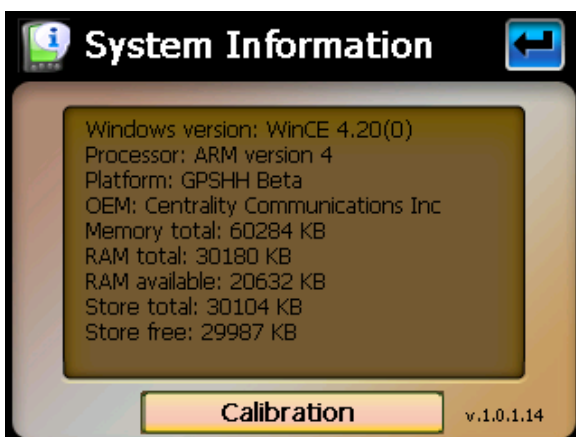

Figure 43 - System Information

This screen displays information about the device.

Index

A

Address • 11
 Address Actions • 13
 Address Modes • 12
 Avoid Road Groups • 25
 Avoid Road Locations • 26
 Avoid Roads • 8, 25

B

Backlight Settings • 43

C

Cancel Route • 20
 Comma-Separated Values • 40
 CSV • *See* Comma-Separated Values
 Cut Map • 38

D

Date-Time Settings • 44
 Defining the Route Groups • 24
 Destination Menu • 7
 Destinator ND Features • 3
 Destinator Technologies • 3

E

Enter Address • 7

F

Favorite Groups • 16
 Favorite Locations • 17
 Favorites' Alert • 16
 Focus the Map • 37
 Focus the Map by Route • 37

G

Gas, Food, Lodging • 7
 General Settings • 9
 Getting Started • 4
 Go to your Destination • 13, 15, 18
 GPS Not Found • 5
 GPS Status • 9, 30

H

Help • 32

I

Installation Requirements • 33
 Installing a Map • 33, 35
 Installing the Console • 33

L

Language Settings • 32, 44
 Load Map • 38

M

Map Browsing • 28
 Map Cutter Screen Interface • 36
 Map Preferences • 9
 Map Screen Interface • 35
 Map Settings • 29
 Map Views • 5, 8
 Maps • 35
 Menus • 7
 Multistop Planner • 23
 My Favorites • 7, 13, 14, 15, 20

O

Options Menu • 8

P

PC Requirements • 33
 Pedestrian Mode • 28
 Plan a Trip • 23
 POI Actions • 20
 POI Convertor • 41
 Point on the Map • 6
 Power Setting • 43
 Prompts • 9

Q

Quick Nav. Settings • 30

R

Recent Locations • 7, 14
 Remove Map • 39
 Route Overview • 20
 Route Planner • 8
 Route Playback • 8, 27

S

Screen Buttons • 9
 Search for a Location • 11
 Search Near a Location • 19
 Select Map • 7, 22
 Set Quick Navigation • 9
 Setting Stops Along the Route • 24
 Settings Menu • 9
 Stops Actions • 25
 System Information • 44
 System Settings • 42
 System Units • 32

T

Technical Support • 34
 Turn-by-Turn • 7
 Tutorial • 3

V

Volume Settings • 43

W

What's on the Map • 4

Working with a Navigation list • 10