

SERVICE CALL: If you have a problem with your appliance ring your local Service Office.

SPARES and ACCESSORIES: To purchase spares and accessories send your Accessories Order Form to your Spares Centre. If the accessory or spare part you want is not on the form then contact your Spares Centre for prices and availability.

Please address all correspondence to Hotpoint Spares Centre or Hotpoint Service Office as applicable.

Service Offices and Spares Centres are open between 8.30am-5.00pm Monday to Friday except on public holidays.

IRELAND

Northern Ireland:
235 Ormeau Road, Belfast,
BT7 2ZJ.
Tel: Belfast 647111.

Eire: 35/36 Arran Quay,
Dublin 7.
Tel: Dublin 725922.

Spares and accessories may be ordered from either address.

NORTH WEST

- **KENDAL:** 28 Highgate, LA9 4SX.
Tel: Kendal 24463.
- **PRESTON:** 24/25 Cannon Street,
PR1 3JN. Tel: Preston 24111.
- **ST HELENS:** 40 Resing Hill,
WA10 2AD. Tel: St. Helens 35152.
- **ELLESMERE PORT:**
1 Church Parade, L55 2ER.
Tel: 051-356 2141.
- **STOCKPORT:** 44/46 Station Road,
Heaton Mersey, SK4 3OT.
Tel: Office 061-442 8677.
Centre 061-432 0255.

WALES

- **LLANUDNO JUNCTION:** Conwy Road,
LL31 9RZ. Tel: Deganwy 82828.
- **BRIDGEND:** 18 Western Avenue,
Bridgend Industrial Estate, CF31 3SL.
Tel: Office Bridgend 64121.
Centre Bridgend 64121.

WEST MIDLANDS

- **STONE-ON-TRENT:** West Avenue,
Rishton Estate, Kilsby Grove, S17 1TN.
- **ALDRIDGE:** W6 74811, W6 80UX.
Tel: Office Aldridge 743374.
Centre Aldridge 743377.

SOUTH MIDLANDS

- **DIDCOT:** 224 Broadway, OX11 9RS.
Tel: Didcot 817711.
- Spares and accessories may be ordered from either Aldridge or Wembley Centres.

SOUTH WEST

- **BRISTOL:** 3/5 Brimsington Hill, Brimsington, BS4 5BP. Tel: Bristol 714471.
- **PLYMOUTH:** 69 Mulvey Place, PL4 6JH. Tel: Plymouth 262631.
- **TOTTEN:** South Hampshire Industrial Park, Salisbury Road, S04 3SA.
Tel: Office Totton 861983.
Centre Totton 867933.

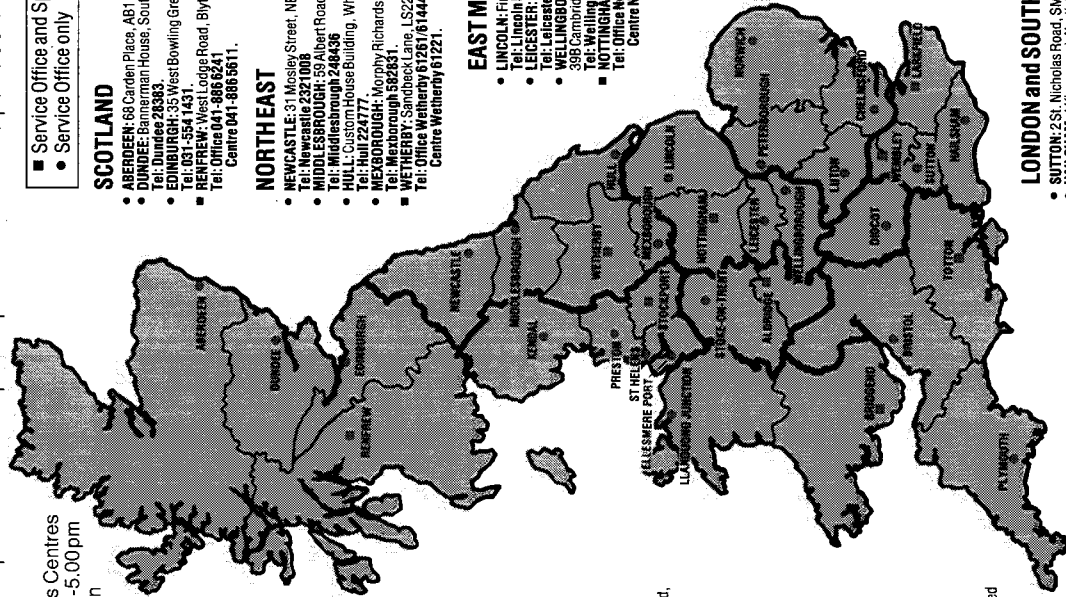

- Service Office and Spares Centre
- Service Office only

SCOTLAND

- **ABERDEEN:** 68 Carden Place, AB1 1UL. Tel: Aberdeen 642283.
- **DUNDEE:** Baneriman House, South Tay Street, DD1 1NR.
Tel: Dundee 28383.
- **EDINBURGH:** 35 West Bowling Green Street, Leith, EH6 5NX.
Tel: 031-554 1431.
- **RENFREW:** West Lodge Road, Blythswood Estate, PA4 9EN.
Tel: Office 041-886 6241.
Centre 041-886 5611.

NORTHEAST

- **NEWCASTLE:** 31 Mosley Street, NE1 1YF.
Tel: Newcastle 222 2209.
- **MIDDLESBROUGH:** 59 Albert Road, TS1 1NG.
Tel: Middlesbrough 248438.
- **HULL:** Custom House Building, Whitefriargate, HU1 2EU.
Tel: Hull 224777.
- **MEXBOROUGH:** Morphy Richards, Swinton Works, S64 8AJ.
Tel: Mexborough 582831.
- **WETHERBY:** Sandbeck Lane, LS22 4TW.
Tel: Office Wetherby 612616/1444.
Centre Wetherby 61221.

EAST MIDLANDS

- **LINCOLN:** Firth Road, LN6 7BW.
Tel: Lincoln 512300.
- **LEICESTER:** 65 Regis Gate, LE1 3HR.
Tel: Leicester 814485.
- **WELLINGBOROUGH:**
296 Kingsway Street, NN8 1DW.
Tel: Wellingborough 223669.
- **NOTTINGHAM:** Ashling Street, NG2 3JB.
Tel: Office Nottingham 862451.
Centre Nottingham 860387.

EASTERN

- **NORWICH:**
92 Upper St. Giles Street,
NR2 1LT.
Tel: Norwich 620581.
 - **PETERBOROUGH:**
Celia Road, PE2 9JB.
Tel: Peterborough 64741.
 - **LUTON:** 5 Crawley Road,
LU1 1HX.
Tel: Luton 452211.
Centre Luton 452211.
- Industrial Buildings
Beauly Lane, CM2 0TE
Tel: Chelmsford 288331.
- Spares and accessories may be ordered from
Hotpoint Spares Administration Dept.
Celia Road, Peterborough,
PE2 9JB. Tel:
Peterborough 68989.

LONDON and SOUTH EAST

- **SUTTON:** 251, Nicholas Road, SM1 1EH. Tel: 01-643 0921
 - **HALLSHAM:** 1 Kingswood, North Street, BN27 1DQ.
Tel: Hallsham 842733
 - **WELSHLEIGH:** 6258 Lane, HA9 7PD.
Tel: 0181-898 1100. Tel: Middlesbrough 01-908 1933
- Service Office for London area 01-904 1250
Service Centre 01-904 0201
- **LARKFIELD:** Larkfield Trading Estate, New Hythe Lane,
ME20 6SW. Tel: Office Maidstone 76631.
Centre Maidstone 76631.

HOTPOINT DE LUXE DISHWASHER

USER HANDBOOK - MODEL 7840

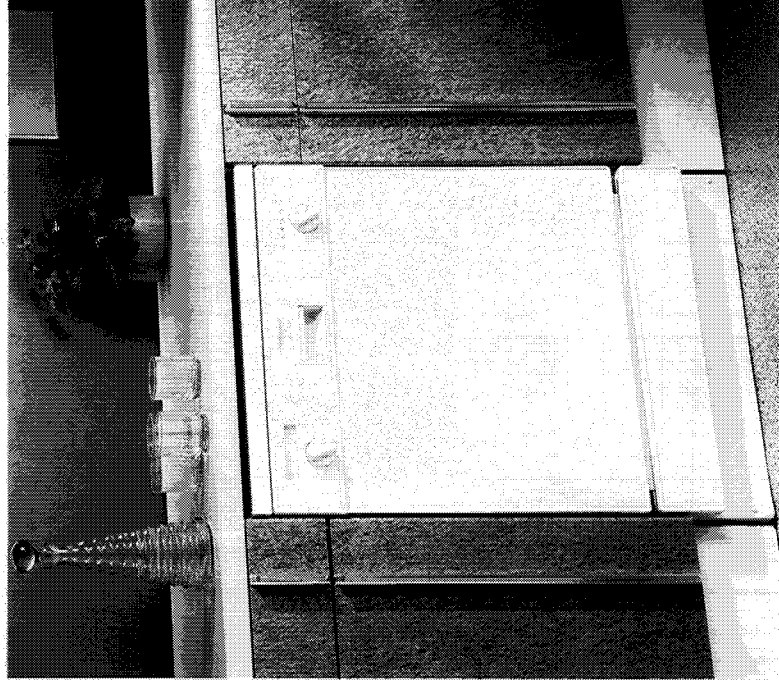

Hotpoint®

In accordance with its policy of progressive product design, the Company reserves the right to alter specifications.

Hotpoint Ltd, Peterborough, England PE2 9JG

Hotpoint Limited is a subsidiary of The General Electric Company, p.l.c.

014/3270/33

Before you operate your new Hotpoint Dishwasher

1. Follow the Installation Instructions booklet supplied with the machine. If it is missing please contact your nearest Hotpoint Spares Centre (see back page) for a replacement. Make sure that the machine is correctly installed.
2. For your own safety and to get the best out of your machine read right through this Handbook **before** using your machine. Once you have read through the Handbook the summary on pages 4 and 5 will remind you of how to operate the machine.
3. Get to know the main parts of your Dishwasher.

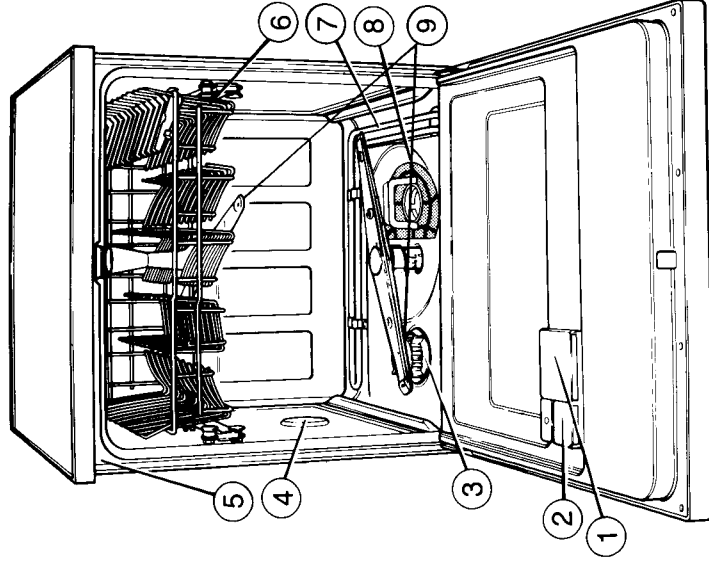

1. Detergent Dispenser (see page 9).
2. Rinse Aid Container with Level Indicator (see page 9).
3. Salt Container Cap (see page 8).
4. Vent, to allow steam to condense during drying.
5. Water Hardness Adjuster (see page 7).
6. Upper Basket (see page 12, for height adjustment).
7. Heater (see note on plastic and wooden items, page 10).
8. Filters (see page 15 for cleaning).
9. Spray Arms.

NOTE: Do not attempt to stand on top of your dishwasher, it is not designed for such use and you could injure yourself or damage the appliance by such abuse.

2

Hotpoint Service Cover

Hotpoint's Consumer Guarantee

From the moment your appliance is delivered, Hotpoint guarantees it for **FIVE YEARS**.

- In the Five Years all replacement parts are **FREE** provided they are fitted by our own Service Engineer. During the first year our Engineer's time and labour is also free.
- After the first year we will charge for our Engineer's time and labour. We do, however, operate our own Service Plan (see opposite) which for an annual payment enables you to cover any repair costs which may be necessary.
- All of our service repairs are guaranteed for twelve months in respect of our labour and any parts fitted.
- The appliance must be used in the United Kingdom and must not be tampered with or taken apart by anyone other than our own Service Engineer.
- You may however, buy parts which can be safely fitted without specialised knowledge or equipment. The correct fitting of such parts provided they are genuine Hotpoint spares, will not affect your Guarantee. Parts are available from your main Hotpoint Spares Centre (see back page).
- Our Guarantee does not cover the cost of any repair which is needed because of power cuts, accidents or misuse. Nor does it cover the cost of any visit to advise you on the use of the appliance except for our Free Installation Check for Automatic Washing Machines and Dishwashers. Please read this instruction book thoroughly to ensure you get the best out of your appliance. If at any time during the Guarantee period we are unable to repair your appliance, we will refund any money paid to us in the previous twelve months. We will also offer you a new appliance, instead of a repair, at a reduced charge.
- Our Guarantee is in addition to and does not affect your legal rights.

- Should you need independent advice on your consumer rights, help is available from your Consumer Advice Centre, Law Centre, Trading Standards Department and Citizens Advice Bureau.

- All Hotpoint servicing is carried out by our own Service Organisation which will be happy to deal with any problems.

Hotpoint's Installation Check

If you ask at your local Service Office (see back page), Hotpoint will send one of its trained Engineers to make sure that the appliance has been properly unpacked and correctly connected to existing water and electrical supplies. If you wish, the Engineer will be happy to explain how to use your new appliance.

Hotpoint's Service Plan

Hotpoint operates a Service Plan which for an annual payment enables consumers to have repairs completed free of charge during the membership period. Consumers may choose to include an annual safety/maintenance check. The Plan starts at the end of the first year of the guarantee and is renewable each year by mutual agreement. The annual fee may change.

To make sure that you have the opportunity to participate in this Plan, please complete and post the Appliance Registration Card to your nearest Hotpoint Service Office. Full details of our Service Plan together with an application form will then be sent to you at the end of the first year of the guarantee. The addresses of our Services Offices are shown on the back page of this Handbook.

Proof of Purchase.

For future reference please attach your purchase receipt for this dishwasher to this booklet and keep it in a safe place.

Spares and Accessories

Spares and accessories can be ordered from your local Hotpoint Spares Centre (listed on the back page), using the order form enclosed.

If it still won't work . . .

Contact the Service Office

If something is still wrong with your machine after you've been through the check-lists on the previous two pages:

1. Switch off and unplug your machine from the mains.
2. Turn off the hot or cold tap.
3. Call your nearest Hotpoint Service Office or local importer (outside the UK). The telephone number is shown on the back page. You can note down the number in this space for convenience:

.....
When you contact us we will want to know the following:

1. Your name, address and post code.
2. Your telephone number.
3. Clear and concise details of the fault.
4. The Model number (7840 for this machine), and the colour.
5. The date of purchase. Enter the date here:

.....

6. If you have taken out a Hotpoint Service Plan.

Please make sure you have all these details ready when you call.

Contents

	page
Before you operate your new Hotpoint Dishwasher	2
How to do a wash	4
Dishwasher-proof items	6
Getting your Hotpoint Dishwasher ready to work	7
Setting the Water Hardness Adjuster	7
Salt, Rinse Aid and Detergent	8
Loading the Dishwasher	10
The Controls	12
Programme Guide	13
When the washing-up is done	14
Caring for your Dishwasher	14
If something goes wrong	16
If it still won't work	18
Hotpoint Service Cover	19
Hotpoint Service Offices and Spares Centres	back page

How to do a wash

Before using your new machine for the first time please refer to page 7 'Getting your Hotpoint Dishwasher ready to work' before proceeding any further.

1. Turn on water

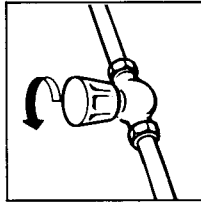

2. Plug in, switch on electricity
WARNING: WHEN SWITCHING ELECTRICITY ON OR OFF PLEASE ENSURE THAT YOUR HANDS ARE DRY.

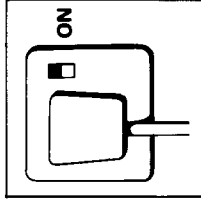

3. Check the Salt Refill Indicator

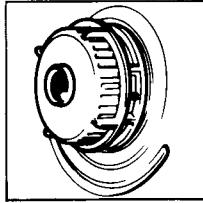

Ensure the green float is showing through the window of the Salt Container (see page 8)

4. Check filters

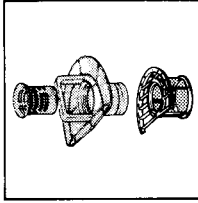

Make sure that filters are clean and correctly positioned (see page 15)
Remember to clean them at the end of the wash

5. Load machine

Do not obstruct spray arms or detergent dispenser (see page 10)

6. Check Rinse Aid Indicator

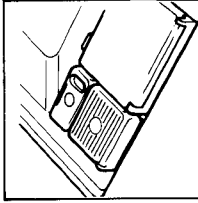

Ensure the window on the rinse aid dispenser is dark red (see page 9)

7. Add Detergent

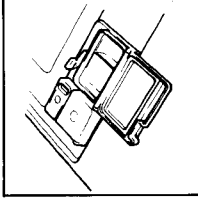

Add relevant quantity of detergent based on type of wash (see page 13)

White deposit left on dishes/Glasses dull or misty

Possible causes:

1. The salt has run out (see page 8).
2. Rinse aid dosage is set too low (see page 9).
3. Lid of Salt Container not screwed down.

Glasses have greasy smears

Make sure that the rinse aid dosage is not set too high (see page 9).

Dishes still wet after drying

Make sure that:

1. Rinse aid dosage is not set too low (see page 9).
2. Water can drain off freely and not collect during drying (see pages 10 and 11).

Food specks left on dishes

Make sure that the filters are properly seated (see page 15).

Water left under the filter

This is perfectly normal, especially after using Quick Wash. It will be rinsed away at the start of the next programme.

Tea/Coffee stains and lipstick left on cups and glasses

You may be using too little detergent (see page 9).

Results are unsatisfactory

Possible causes:

1. Insufficient detergent used (see page 9).
2. Programme selector turned after filling detergent dispenser causing detergent to be lost.
3. Not correctly loaded/overloaded baskets (see pages 10 and 11).
4. Salt needs filling (see page 8).
5. Incorrect rinse aid setting (see page 9).
6. Filters incorrectly fitted or blocked (see page 15).
7. Nozzles in spray arm blocked (see page 14).
8. Spray arms obstructed by the dishes (see pages 10 and 11).
9. Incorrect programme selected (see page 13).

Rattling noises

Make sure that the utensils are correctly arranged (see pages 10 and 11).

If something goes wrong...

Firstly, don't panic! There may be nothing wrong at all. Look for your problem below, then check the things we suggest. More often than not this will give you the answer to your problem, and you'll be able to carry on without having to telephone your Hotpoint Service Office.

If after this you still cannot get your machine to work, follow the advice given on page 18.

Problem	Checklist
It won't start	<p>Make sure that:</p> <ol style="list-style-type: none"> 1. The machine is plugged in and switched on at the socket. 2. The door is securely closed. 3. You have selected a programme and switched on. 4. The water supply is turned on. 5. The hoses are not kinked. 6. The fuses in the plug and main fuse box are OK. <p>Try plugging in another appliance to check. If the fuse has blown refer to Electrical Requirements on page 2 of the Installation Handbook.</p>
It won't fill	<p>Make sure that:</p> <ol style="list-style-type: none"> 1. You have not forgotten to turn on the tap. 2. The inlet hose is not kinked.
It won't empty	<p>Make sure that:</p> <ol style="list-style-type: none"> 1. The drain hose is not kinked. 2. The filters are not blocked (see page 15).
The machine's leaking	<p>Make sure that:</p> <ol style="list-style-type: none"> 1. The inlet and drain hoses are firmly attached to the machine. To do this remove the kick strip and trim panel (see Installation booklet). 2. The inlet hose is firmly attached to the water supply. 3. If your machine is not permanently plumbed in; did you empty the hose into a bucket after disconnecting it from the tap? 4. If your machine is permanently plumbed in; is the standpipe at the correct height (500 mm/20 in min) and is it the correct bore size (32 mm/1¼ in min.)? 5. Could it be condensation from the wall?
It keeps stopping and making clicking noises	<p>Don't worry, the timer is working and selecting the next operation, and there are also pauses whilst the water heats up.</p>

8. Close door

Make sure that dishwasher door clicks shut

9. Select programme

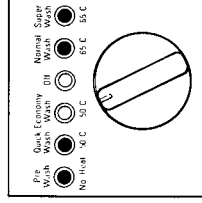

Turn programme selector to the relevant programme (see page 12)
NOTE: See page 12 for selecting the Quick Wash programme

10. Switch on machine

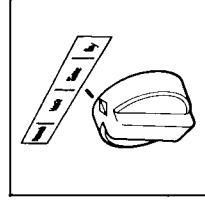

Turn the timer control clockwise until the **♦** on the control lines up with the mark on the fascia (see page 12)

11. Turn off the machine

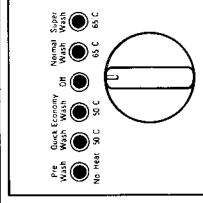

When the machine has completed its programme turn the Programme Selector to the off position (see page 13)

12. Switch off electricity

WARNING: WHEN SWITCHING ELECTRICITY ON OR OFF PLEASE ENSURE THAT YOUR HANDS ARE DRY

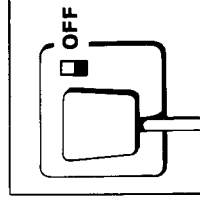

Turn off water

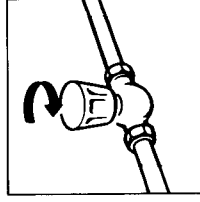

13. Remove wash load

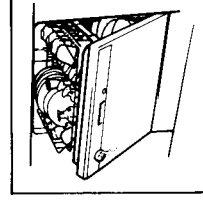

Allow 15 minutes for the load to cool. Unload lower rack first (see page 14) Remember to clean filters

What items are not dishwasher-proof?

This is always the first question asked by anyone who has bought a dishwasher for the first time, so we will answer it before we go any further.

The items **not** suitable for washing in a dishwasher are:

Cutlery with wooden or bone handles

Pans with wooden handles

Parts joined by adhesive

Plastic, copper or tin items which cannot resist hot water

'On-glaze' decorated china, aluminium and silver items can discolour or fade

Lead crystal glassware can become opaque after being washed many times.

If you are in any doubt check with the manufacturers of the china, pans, and cutlery on their dishwasherability.

Can I only wash dishes in my dishwasher?

No, there are many more items you can wash in a dishwasher than you imagine, for example:

Oven furniture, hob fittings, stainless steel items, teapots, coffee pots, glass

microwave turntables, food processor and mixer attachments. **If you are in any doubt check with the manufacturers of the items on their dishwasherability.**

WARNING: DO NOT ATTEMPT TO WASH ITEMS IN YOUR DISHWASHER WHICH HAVE CONTAINED POISONOUS OR DANGEROUS SUBSTANCES.

Special care notes

Stainless steel items

Stainless steel is very good for washing in the dishwasher. Some types however can become tarnished by the humid atmosphere in the dishwasher during drying.

To avoid this remove the items at the end of the rinse programme and wipe dry.

Any staining will not harm the items and can be removed with a proprietary stainless steel cleaner.

Silverware

Silverware can be washed in your dishwasher but should not be washed alongside stainless steel items as this could cause corrosion of the stainless steel.

To 'polish' tarnished silver and A1 EPNS, Hotpoint makes a *Silverware Cassette*, Part No. 7004. This can be ordered through your retailer or nearest Hotpoint Spares Centre, see back page, using the enclosed order form.

It is placed in the cutlery basket and the silver cutlery placed inside. The areas of discolouration will disappear after a few washes.

It should be noted that any decorative toning on the handles of silverware will eventually fade, so if this is of particular importance to you do not wash such items in the dishwasher.

Cleaning the Filters

This is the most important item of maintenance you have to do.

The filters are found on the bottom of the machine on the right-hand side (see page 2).

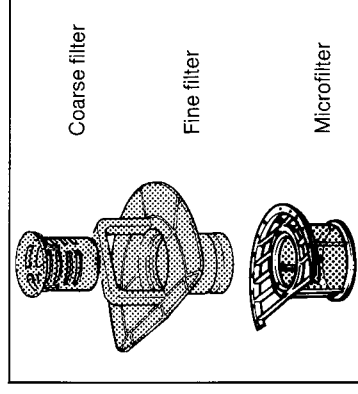

The coarse and fine filters can be lifted out by the handle on the fine filter. They are simply pushed together and pulled apart. They should be cleaned under running water after every wash.

The microfilter is a push fit device which sits in the base of the machine and can be removed by lifting straight upwards.

It should be inspected in place after every wash and removed and cleaned when necessary, and at least after every five washes.

When replacing make sure that the microfilter clips firmly into place and that the edges are flush with the base of the machine. The coarse and fine filters should then be reassembled and located back inside the microfilter, again with the edges flush with the base of the machine.

When the washing-up is done

The machine stops automatically when the programme is finished.

Switching off

The first thing you should do is to switch the machine off by turning the Programme Selector to Off (Mains Indicator Light will go out) and switching off the power at the mains socket.

Turn off the water

If you have finished washing always turn off the water at the stopcock, or tap. If you do not have permanent plumbing you will also need to disconnect the water supply and stow the drain hose after emptying it in a bucket.

Unloading

Allow the load to cool for about 15 minutes.
Unload the lower rack before the upper rack to avoid any drops of water falling on the lower dishes when the upper rack is moved.

Caring for your Dishwasher

Your Hotpoint Dishwasher needs very little attention. The following steps will keep it performing well.

NOTE: Before doing any cleaning check that the electricity supply to the machine is switched off.

1. Clean the spray arms occasionally. To do this, remove the arms (the lower arm clips into place and can be removed by lifting upwards) and brush them under fresh running water or use a mild soap or detergent solution. They need to be kept clean to keep the jets clear and spraying properly.
2. Clean the metal surfaces on the outside of your machine with a damp cloth only. **Do not use** any abrasive cleaners or metal polishes, otherwise you will damage the protective coating on these parts.
3. If the machine is not going to be used for a long time leave the door ajar to allow air to circulate inside.
4. We recommend you take out a Hotpoint Service Plan with Annual Safety/Maintenance Check which ensures the machine is professionally serviced every year. Details are given on page 19 of this Handbook.

Hotpoint strongly recommends that all of its appliances are regularly checked for electrical and mechanical safety whether or not they are covered by a Hotpoint Service Plan. This is to avoid such things as worn hoses which may cause a leak on an appliance which could become dangerous if neglected.

WARNING: IT IS POSSIBLE FOR CHILDREN TO CLIMB INTO DISHWASHERS AND INJURE THEMSELVES. ALWAYS SWITCH ELECTRICITY OFF AT SOCKET AND REMOVE PLUG AFTER USE.

Aluminium items

Bright polished, matt, enamelled and non-stick coated aluminium items are all suitable for washing in a dishwasher.

However aluminium is vulnerable to everyday minerals found in water, which could lead to discolouration during rinsing. If items show signs of discolouration they should be removed immediately after the washing cycle and rinsed in cold water by hand. This discolouration will not, however, seriously affect the aluminium.

WARNING: TAKE SPECIAL CARE WHEN REMOVING ITEMS IMMEDIATELY AFTER A WASH AS THEY MAY BE VERY HOT.

Getting your Hotpoint Dishwasher ready to work

Before you can use your dishwasher you must first carry out the following steps to ensure that you obtain the best possible wash performance from your machine.

Setting the Water Hardness Adjuster

In order to ensure the correct amount of salt is being used to regenerate the water softener the Water Hardness Adjuster needs to be set accordingly. To set this you need to ascertain the degree of hardness of your water supply.

This is very easy to do if you follow the following steps:

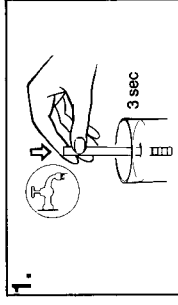

1. Take the test strip (supplied with this handbook) out of its plastic seal and dip it for 3 seconds into a container of mains water so that both zones of the strip are covered.

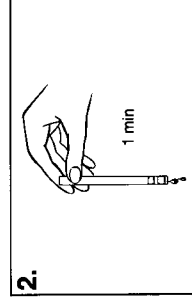

2. Remove the test strip from the water, wait for one minute and observe any colour change.

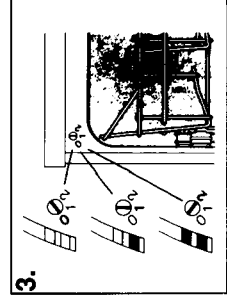

If both areas remain greenish you are in a soft water area. Set the Water Hardness Adjuster to 0, by using a screwdriver or coin.

If one of the two zones turns reddish the Water Hardness Adjuster should be set at 1.

If both zones turn reddish you are in a very hard water area and the Water Hardness Adjuster should be set at 2.

If in any doubt, please consult your nearest Hotpoint Service Office for advice (see back page).

After setting the Water Hardness Adjuster you will need to add salt to the machine (see page 8).

Salt, Rinse Aid and Detergent

In order to function properly your dishwasher needs a supply of the above three items. Salt and rinse aid are added occasionally whilst detergent is added everytime you wash a load.

Various manufacturers sell dishwasher rinse aid and detergent, most of which are suitable for your Hotpoint Dishwasher. We particularly recommend *Sun* as it gives excellent results on all programmes and loads.

Salt

Salt is used to regenerate the resins in the water softener which aids both washing and rinsing, and avoids the furring-up of the internal parts of the machine. In areas with very soft water you will not need salt very often but you should occasionally use it to avoid the risk of furring up.

NOTE: Only use special granular or tablet salt. Do not use table salt, cooking salt or road salt as they contain insoluble substances which could harm the dishwasher.

How to fill the Salt Container

The Salt Container is located on the bottom left-hand side of the dishwasher (see page 2). Remove the lower basket and turn the Salt Container Cap anti-clockwise. When the machine is new pour in 0.5 litre (1 pint) of water and then add 2.5 kg (5½lb) of salt.

NOTE: Be careful not to overflow when using tablet salt or you may not be able to refit the Salt Container Cap, keep the salt load down to 1.5 kg (3lb 5 oz).

Replace the cap and switch the machine to the Prewash programme, (see page 12 for programme selection), which will rinse away any spilled salt solution.

Salt Refill Indicator

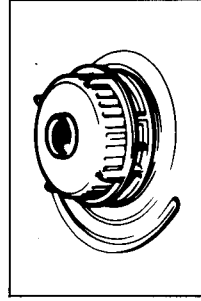

The Salt Refill Indicator is a green float built into the Salt Container Cap. When there is sufficient salt in the machine, you will see the green float through the window in the cap. When the float disappears refill the Salt Container remembering to use the Prewash programme afterwards to rinse away any spilled salt solution.

Rinse Aid

Rinse aid ensures quick drying and avoids the water spots and streaks which normally occur when a wet object is allowed to dry in the air.

NOTE: Only use rinse aid designed for use in dishwashers, do not use normal washing-up liquid.

During periods where the water is being heated the Indicator will remain stationary for some time, so don't worry.

After all programmes except Quick Wash and Prewash the Indicator returns to the left-hand side of the display.

After Quick Wash the Indicator stops in the Dry section and returns when the next programme is selected.

After Prewash it stops at the beginning of the Wash section. To return the Indicator to the Prewash section you should turn the Programme Selector to 'Off' and then turn the Timer Knob clockwise until the **♦** is in the 12 o'clock position and it lines up with the mark on the fascia. The Indicator will flick back to the Prewash section.

Economy 7

Your dishwasher can be used with Economy 7 or any other cheap rate electricity using a **separate** time switch into which the dishwasher is plugged.

To do this press the mains switch to 'Off', select the programme (see page 12), set the separate time switch, turn the Timer Knob to the appropriate start position and press the mains switch to 'On'. The machine will start when the time switch turns on the power.

Programme Guide

Programme	Pre Wash	Quick Wash	Economy Wash	Normal Wash	Super Wash
Temperature	No heat	50°C	50°C	65°C	65°C
Type of utensil	All	All	Glasses Fine porcelain Breakfast dishes	Glasses Fine porcelain Breakfast dishes Supper dishes Daily dishes Cutlery	Fine porcelain Breakfast dishes Supper dishes Daily dishes Cooking utensils Cutlery Oven/Hob fittings
Soiling level	All	Light	Normal or slight	Normal or slight	Heavy
Load Level	Any	Half	½-Full	Full	Full
Detergent quantity	None	15cc or less Small Chamber	15cc or more Small Chamber	25cc Large Chamber	25cc Large Chamber
Programme time (min)	10	35	66	78	80
Cold fill	10	17	42	42	42
Hot fill (70°C)*					

*These times are approximate as they are dependent upon your household water pressure.

Use of the Programmes

- Prewash**
- Use each day when utensils are collected over a period of several days to prevent food deposits from becoming hardened.
- Quick Wash**
- Use for those lightly soiled utensils which you urgently require.
- Economy Wash**
- Suitable for light to normal soiled utensils which are to be washed on the same day.
- Normal Wash**
- Suitable for most loads including those collected over several days providing Prewash has been used.
- Super Wash**
- Use when dealing with heavily soiled items such as pots and pans, oven fittings, teapot, or anything else with baked-on food deposits.

Adjusting the height of the upper basket

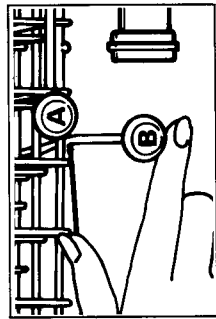

You can adjust the height of the upper basket if required. The upper basket can be put in on the upper rollers (A) or on the lower rollers (B) in order to make more room in either the upper or lower basket for tall utensils.

The Controls

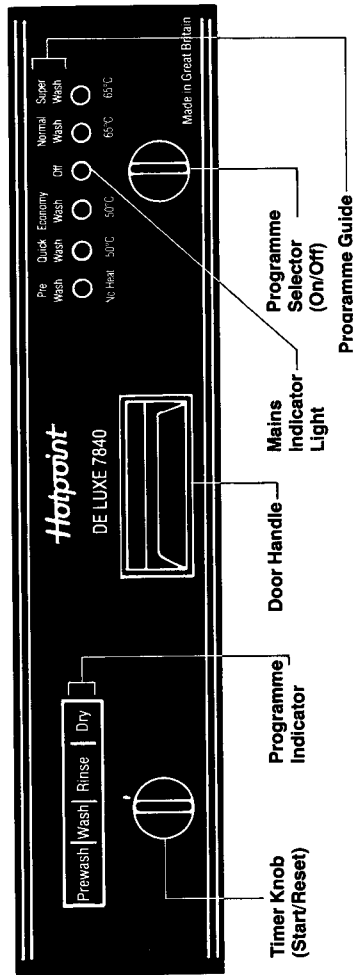

Selecting a Programme (other than Quick Wash)

Turn the Programme Selector to the required programme (see Programme Guide on page 13 for the best programme), the Mains Indicator Light will come on. To start the machine turn the Timer Knob clockwise until the \blacklozenge on the knob reaches the 12 o'clock position and it lines up with the mark on the fascia. The machine will then start.

NOTE: The Timer knob should never be turned anti-clockwise.

Selecting Quick Wash

When the Programme Selector is in the 'off' position, turn the Timer Knob clockwise until the Q symbol on the Timer Knob lines up with the mark on the fascia.

You can now turn the Programme Selector to the Quick Wash programme, the Mains Indicator Light will come on and the machine will then start.

Programme Progress Indicator

As the programme proceeds the Progress Indicator will move across the display to indicate which stage of the wash process the machine is at. The Indicator will move from left to right as shown below.

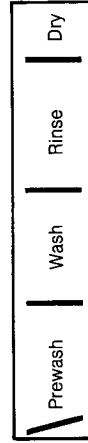

How to fill the Rinse Aid Container

The Rinse Aid Container is located on the back of the dishwasher door (see page 2).

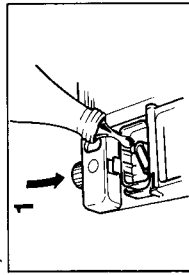

Open the container by pressing the red button (arrow 1), the lid will spring open. Pour in approximately 200ml (1/3 pint) of rinse aid. Close the lid firmly so that it clicks shut.

Adjusting the Rinse Aid Dispenser

The dispenser automatically adds rinse aid to the final rinse. The amount it dispenses can be adjusted using the slot as shown (arrow 2).

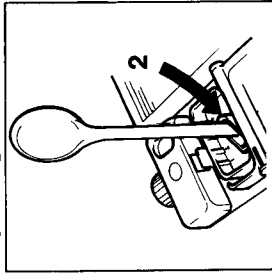

Any position from 1-4 can be chosen, the higher numbers dispense more rinse aid. We suggest that you initially set it between 3 and 4 and then adjust it in the light of your own experience.

Pages 16-17 highlight the faults found on washing with too much or too little rinse aid.

Rinse Aid Refill Indicator Window

When full this window will appear as a dark red colour (arrow 3). When the window becomes light red (after about 30 rinses on setting 3) you should refill the dispenser.

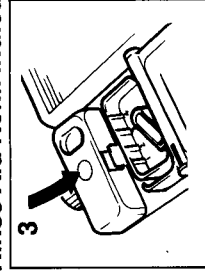

Detergent

The Detergent Dispenser is next to the Rinse Aid Dispenser (see page 2), and it should be filled before each wash.

NOTE: Only use special dishwasher detergent. Do not use ordinary washing-up liquids or washing powders.

Filling the Detergent Dispenser

The dispenser will normally be open after a programme has finished. If not press the red button underneath and the lid will spring open (arrow 4).

The dispenser has two chambers. If you are using a Normal Wash or Super Wash programme fill the larger 25cc chamber. If you are using an Economy Wash or Quick Wash programme fill the smaller 15cc chamber. You can of course vary these quantities in the light of your own experience.

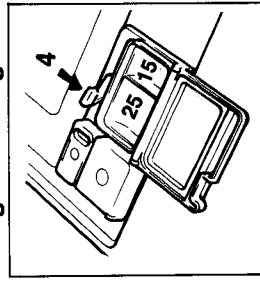

When filled close the lid firmly so that it clicks shut. It will automatically spring open during the programme to release the detergent.

Loading the Dishwasher

Your dishwasher is designed to take 12 standard place settings.

There is no one correct method for loading the dishwasher. The upper and lower baskets are designed to give the maximum flexibility possible to cope with the almost infinite variety of cups, glasses, dishware, pots, pans and utensils – not to mention your oven fittings or teapot – which might be put into them.

Loading

- Firstly remove all excess food, as you would for hand washing.
- Arrange all items so that water can drain away, as you would on a draining board.
- Large or heavily soiled articles should go in the lower baskets. The upper basket can be adjusted to allow for large items in the lower basket (see page 11). Smaller, delicate items (eg glasses) should go in the top basket.
- Arrange plates so that they are not touching and water can flow freely between them.
- Tall, narrow receptacles should be placed in the centre of the baskets directly over the spray.
- Long stemmed glasses should lean against the cup rack not against dishware (see upper photograph).
- Cutlery should be distributed randomly in the cutlery basket with handles down (except if the handles are very thin and could drop through the basket).
- Long cutlery, such as ladles and knives should be laid horizontally across the filled cutlery basket (see lower photograph).
- Pots and pans with baked-on areas should be arranged so that the water jets can have direct access to the dirty areas.
- Do not block the funnel in the centre of the upper basket.
- After loading check that the upper spray arm is free to rotate by giving it a spin with your hand.

WARNING
MAKE SURE LIGHT PLASTIC/WOODEN ITEMS ARE WEIGHTED DOWN WITH HEAVIER OBJECTS SO THAT THEY CANNOT BECOME DISLODGED AND COME INTO CONTACT WITH THE HEATER (SEE PAGE 2). DO NOT PLACE THESE ITEMS DIRECTLY ABOVE THE HEATER.
TAKE EXTRA CARE WHEN LOADING AND UNLOADING SHARP ITEMS SUCH AS KNIVES.

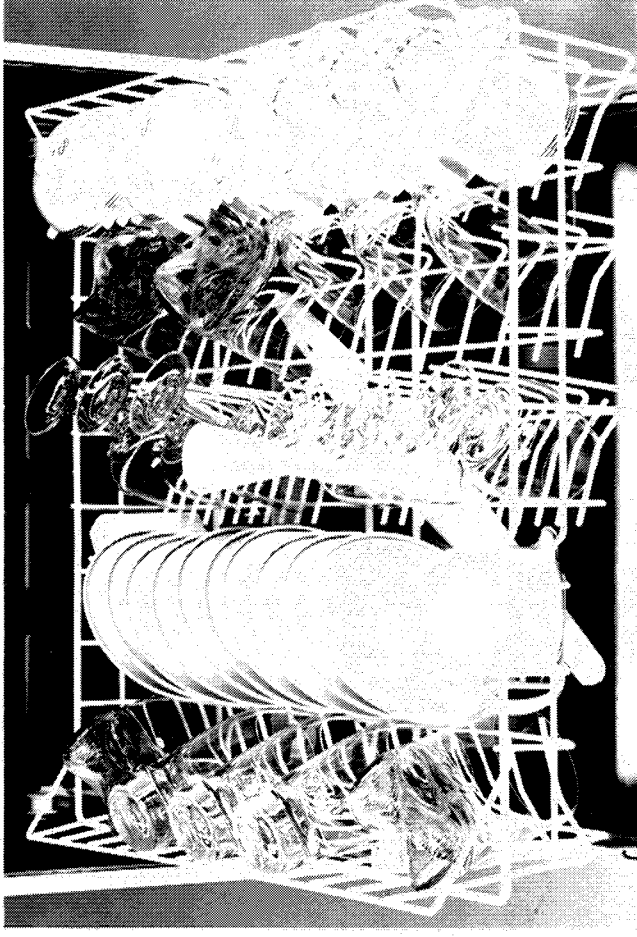

Upper Basket

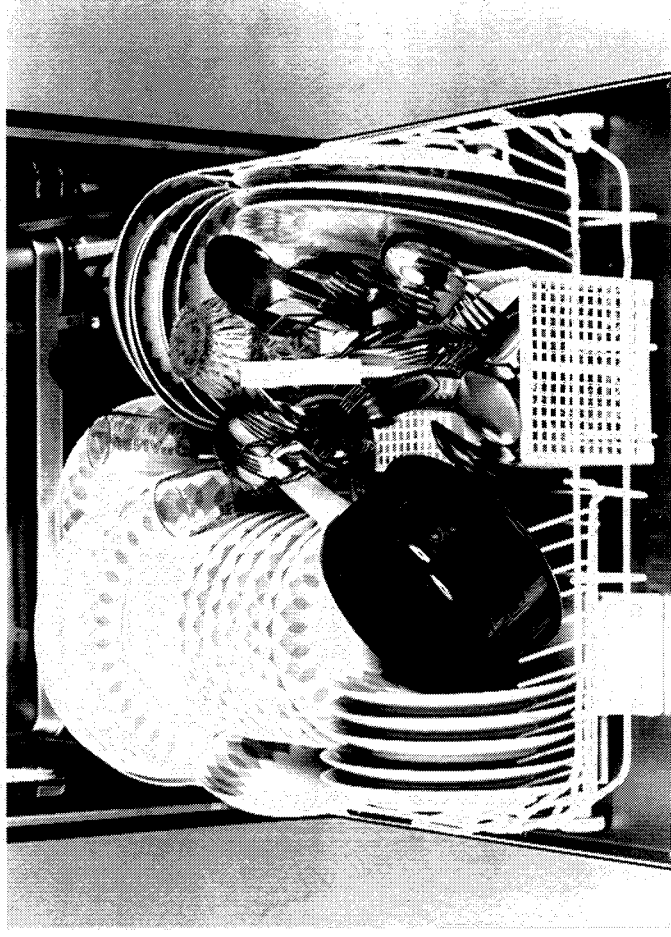

Lower Basket

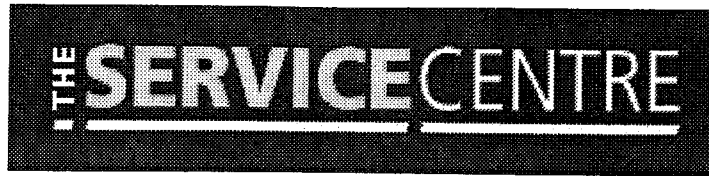

Key Contacts

After Sales Service

Over 1100 trained specialists, directly employed by us, ensure that you have complete confidence in both the appliances and services we offer.

Repair Service

UK: 08709 066 066

(Open 8 to 8 Mon - Fri, 8 to 6 Sat & 10 to 4 Sun)

www.theservicecentre.co.uk

Republic of Ireland: 1850 302 200

Note: Our Service Operators will require the following information:

Model Number

Serial Number

Extended Warranties

UK: 08709 088 088

(Open 8 to 6 Mon - Fri)

www.theservicecentre.co.uk

Republic of Ireland: 1850 502 200

Genuine Parts and Accessories

UK: 08709 077 077

(Open 8-30 to 5-30 Mon - Fri, 8-30 to 12 Sat)

www.theservicecentre.co.uk

Republic of Ireland: (01) 842 6836

General Domestic Appliances Limited, Morley Way, Peterborough, PE2 9JB