

Poulan®

ENGLISH



Please do not return unit to retailer.
Por favor, no devuelva el aparato al lugar de compra.
Veuillez ne pas retourner l'outil au détaillant.

1-800-554-6723

www.poulan.com

Instruction Manual Manual de Instrucciones Manuel d'Instructions

PLN3516F

ESPAÑOL

245157



WARNING:

Read and follow all Safety Rules and Operating Instructions before using this product. Failure to do so can result in serious injury.

ADVERTENCIA:

Lea el manual de instrucciones y siga todas las advertencias e instrucciones de seguridad. El no hacerlo puede resultar en lesiones graves.

AVERTISSEMENT:

Lire le manuel d'instructions et bien respecter tous les avertissements et toutes les instructions de sécurité. Tout défaut de le faire pourrait entraîner des blessures graves.

Poulan
1030 Stevens Creek Road
Augusta, GA 30907

Poulan
850 Matheson Blvd, West
Mississauga, Ontario L5V 0B4

FRANÇAIS

9096-212604

INTRODUCTION

TABLE OF CONTENTS

1	GENERAL INFORMATION	3
	1-1. General Identification	
	1-2. Safety Features	
	1-3. Glossary	
	1-4. Specification	
2	SAFETY PRECAUTIONS	5
	2-1. Kickback Safety Labels	
	2-2. Important Safety Instructions	
	2-3. Other Safety Precautions	
	2-4. General Safety Precautions for chain saw users	
	2-5. More About Kickback	
	2-6. International Symbols	
3	ASSEMBLY INSTRUCTIONS	9
	3-1. Introduction	
	3-2. Assembly Requirements	
	3-3. Guide Bar / Saw Chain Installation	
	3-4. Saw Chain Tension Adjustment	
	3-5. Filling Oil Tank	
	3-6. Selecting the Proper Extension Cord for Your Saw Model	
4	OPERATING INSTRUCTIONS	11
	4-1. To Start Saw	
	4-2. To Stop Saw	
	4-3. Chain and Bar Lubrication	
	4-4. CHAIN BRAKE® / Hand Guard	
	4-5. Extension Cords	
5	GENERAL CUTTING INSTRUCTIONS	13
	5-1. Felling	
	5-2. Limbing	
	5-3. Bucking	
	5-4. Bucking Using a Sawhorse	
6	BAR / CHAIN MAINTENANCE	15
	6-1. Guide Bar Maintenance	
	6-2. Chain Maintenance Instructions	
7	BAR / CHAIN MAINTENANCE	17
	7-1. Preventive maintenance	
	7-2. Chain Replacement Information	
8	LIMITED WARRANTY	18

1 - GENERAL INFORMATION

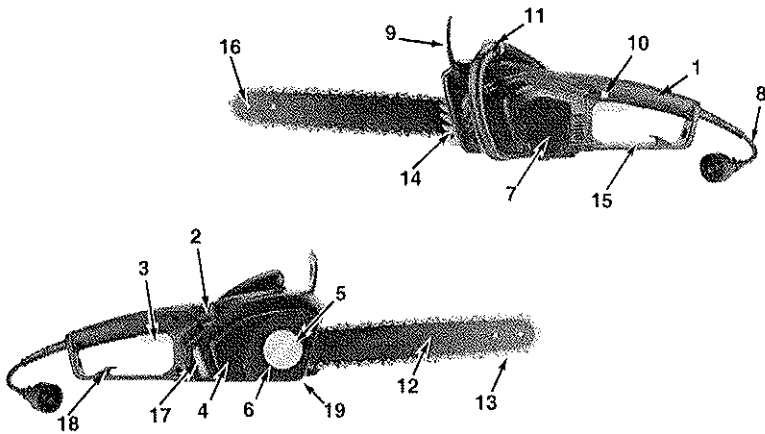

1-1. GENERAL IDENTIFICATION

1. REAR HANDLE
2. OIL TANK CAP
3. TRIGGER START/STOP SWITCH
4. SPROCKET COVER
5. BAR BOLT KNOB
6. CHAIN TENSION RING
7. ELECTRIC MOTOR
8. ELECTRIC CORD
9. CHAIN BRAKE[®] LEVER / HAND GUARD
10. LOCK / OFF BUTTON
11. FRONT HANDLE
12. GUIDE BAR
13. SAW CHAIN
14. SPIKES
15. REAR HAND GUARD
16. SPROCKET
17. OIL TANK WINDOW
18. CORD RETAINER
19. CHAIN CATCHER

1-2. SAFETY FEATURES

Numbers preceding the descriptions correspond with the numbers on preceding page to help you locate the safety feature.

- 3 TRIGGER START / STOP SWITCH** stops saw motor when released.
- 7 ELECTRIC MOTOR** is double insulated for added safety.
- 9 CHAIN BRAKE[®] LEVER / HAND GUARD** activates the chain brake and protects the operator's left hand in the event it slips off the front handle while saw is running.
- 10 LOCK / OFF BUTTON** prevents accidental acceleration of the saw motor. The trigger cannot be squeezed unless lock/off button is depressed.
- 12 GUIDE BAR** Reduced kickback guide bar reduces the intensity of kickback.
- 13 LOW-KICKBACK CHAIN** helps significantly reduce kickback, or the intensity of kickback, due to specially designed depth gauges and Guard links.
- 19 CHAIN CATCHER** reduces the danger of injury in the event saw chain breaks or derails during operation. The catcher is designed to intercept a whipping chain.

1-3. GLOSSARY

1. **BUCKING** - The process of cross cutting felled tree or log into lengths.
2. **CHAIN BRAKE** - A device used to stop the chain saw.
3. **CHAIN SAW POWERHEAD** - A chain saw without the saw chain and guide bar.
4. **DRIVE SPROCKET OR SPROCKET** - The toothed part that drives the saw chain.
5. **FELLING** - The process of cutting down a tree.
6. **FELLING BACK CUT** - The final cut in a tree felling operation made on the opposite side of the tree from the notching undercut.
7. **FRONT HANDLE** - The support handle located at or toward the front of the chain saw.
8. **FRONT HANDLE GUARD** - A structural barrier between the front handle of a chain saw and the guide bar, typically located close to the hand position on the front handle and sometimes employed as an activating lever for a chain brake.
9. **GUIDE BAR** - A solid railed structure that supports and guides the saw chain.
10. **KICKBACK** - The backward or upward motion, or both of the guide bar occurring when the saw chain near the nose of the top area of the guide bar contacts any object such as a log or branch, or when the wood closes in and pinches the saw chain in the cut.
11. **KICKBACK, PINCH** - The rapid pushback of the saw which can occur when the wood closes in and pinches the moving saw chain in the cut along the top of the guide bar.
12. **KICKBACK, ROTATIONAL** - The rapid upward and backward motion of the saw which can occur when the moving saw chain near the upper portion of the tip of the guide bar contacts and object, such as a log or branch.
13. **LOW-KICKBACK CHAIN** - A chain that complies with the kickback performance requirements of ANSI B175.1-1991 when tested on a representative sample of chain saws.
14. **NORMAL CUTTING POSITION** - Those positions assumed in performing the bucking and felling cuts.
15. **NOTCHING UNDERCUT** - A notch cut in a tree that directs the tree's fall.
16. **OILER CONTROL** - A system for oiling the guide bar and saw chain.
17. **REAR HANDLE** - The support handle located at or toward the rear of the saw.
18. **REDUCED KICKBACK GUIDE BAR** - A guide bar which has been demonstrated to reduce kickback significantly.
19. **REPLACEMENT SAW CHAIN** - A chain that complies with the kickback performance requirements of ANSI B175.1-1991 when tested with specific chain saws. It may not meet the ANSI performance requirements when used with other saws.
20. **SAW CHAIN** - A loop of chain having cutting teeth, that cut the wood, and that is driven by the motor and is supported by the guide bar.
21. **SPIKED BUMPER (SPIKE)** - The pointed tooth or teeth for use when felling or bucking to pivot the saw and maintain position while sawing.
22. **SWITCH** - A device that when operated will complete or interrupt an electrical power circuit to the motor of the chain saw.
23. **SWITCH LINKAGE** - The mechanism that transmits motion from a trigger to the switch.
24. **SWITCH LOCKOUT** - A movable stop that prevents the unintentional operation of the switch until manually actuated.

1-4. SPECIFICATIONS

Model No.PLN3516F
Input120V~, 60Hz, 13.5 Amp
Peak Horsepower3.5HP
No Load Speed5500/min
Bar Length16" (40cm)
Cutting Speed10.5 m/sec
Chain Oil Capacity180ml
Net Weight (Without guide bar and chain)4.2 kg (9.24 Lbs)

2 - SAFETY PRECAUTIONS

SAFETY PRECAUTIONS FOR CHAIN SAW USERS (ANSI/UL 1662-1995) (CAN/CSA-Z62.1-03)

2-1. KICKBACK SAFETY LABELS



1. Worst-case computed kickback angle.



2. Avoid bar nose contact.



3. Beware of kick back.



4. Do not attempt to hold saw with one hand.



RECOMMENDED

5. Hold Saw properly with both hands.

2-2. IMPORTANT SAFETY INSTRUCTIONS

1. **REPLACEMENT PARTS** - When servicing use only identical replacement parts.
2. **POLARIZED PLUGS** - To reduce the risk of electric shock, this equipment has a polarized plug (one blade is wider than the other). This plug will fit in a polarized extension cord only one way. If the plug does not fit fully in the extension cord, reverse the plug. Do not change the plug in any way.
3. **KEEP THE WORK AREA CLEAN:** Cluttered areas invite injuries. Do not start cutting until you have a clear work area, secure footing, and a planned retreat path from the falling tree.
4. **CONSIDER THE WORK AREA ENVIRONMENT:** Use extreme caution when cutting small sized brush and saplings because the slender material may catch the saw chain and be whipped toward you or pull you off balance. Do not operate a chain saw in a tree unless specifically trained to do so. When cutting a limb that is under tension, be alert for spring back so that you will not be struck when the tension in the wood fibers is released. Do not expose the chain saw to rain. Do not use the chain saw in damp or wet locations. Do not use the chain saw in presence of flammable liquids or gases.
5. **GUARD AGAINST ELECTRIC SHOCK:** Prevent body contact with grounded surfaces. For example: metal pipes, wire fences.
6. **KEEP CHILDREN AWAY:** Do not let visitors contact the chain saw or extension cord. All visitors should be kept away from the work area.
7. **STORE IDLE CHAIN SAW:** When not in use, chain saws should be stored in a dry, and high or locked-up place - out of the reach of children. When storing saw, use a scabbard or carrying case.
8. **DO NOT FORCE CHAIN SAW:** It will do the job better and safer at the rate for which it was intended.
9. **USE RIGHT TOOL:** Cut wood only. Don't use chain saw for purposes not intended - for example - Don't use the chain saw for cutting plastic, masonry, or nonwood building materials.
10. **DRESS PROPERLY:** Do not wear loose clothing or jewelry. They can get caught in moving parts. Rubber gloves and non-skid footwear are recommended when working outdoors. Wear protective hair covering to contain long hair.
11. **USE SAFETY GLASSES:** Also use safety footwear; snug fitting clothing; protective gloves; head safety chaps protection.
12. **CARRYING SAW:** Carry the chain saw by the front handle with the saw stopped, finger off the switch, the guide bar and saw chain to the rear.
13. **MAINTAIN CHAIN SAW WITH CARE:** Inspect chain saw cords periodically and if damaged, have repaired by authorized service facility. Keep cord clear of the chain and operator at all times. Never carry saw by the cord or pull it to disconnect from receptacle. Keep the cord free from oil and away from sharp edges. Inspect extension cords periodically and replace if damaged. Keep tools sharp and clean for better and safer performance. Follow instructions for lubricating and changing accessories. Keep handles dry, clean and free from oil and grease.
14. **DISCONNECT CHAIN SAW:** Disconnect the chain saw when not in use, before servicing, and when changing accessories and attachments, such as saw chain and guard.

15. **OUTDOOR EXTENSION CORDS:** Use only extension cords intended for outdoor use and marked accordingly.
16. **STAY ALERT:** Watch what you are doing. Use common sense. Do not operate the chain saw when you are tired. Keep all parts of the body away from the saw chain when the motor is operating. Before you start the saw, make sure the saw chain is not contacting anything.
17. **CHECK DAMAGED PARTS:** Before further use of the chain saw, a guard or other part that is damaged should be carefully checked to determine that it will operate properly and perform its intended function. Check for alignment of moving parts, binding of moving parts, breakage of parts, mounting, and any other conditions that may affect its operation. A guard or other part that is damaged should be properly repaired or replaced by an authorized service center unless otherwise indicated elsewhere in this instruction manual.
18. **GUARD AGAINST KICKBACK:**

WARNING:

Kickback may occur when the nose or tip of the guide bar touches an object, or when the wood closes in and pinches the saw chain in the cut. Tip contact in some cases may cause a lightening fast reverse action, kicking the guide bar up and back towards the operator. Pinching the saw chain along the top of the guide bar may push the guide bar rapidly back towards the operator. Either of these reactions may cause you to lose control of the saw which could result in serious injury to the user. The following precautions should be followed to minimize kickback:

- A. **GRIP SAW FIRMLY:** Hold the chain saw firmly with both hands when the motor is running. Use a firm grip with thumbs and fingers encircling the chain saw handles. Note : If a manual oiler control is provided, additional or modified instructions regarding its use is to be provided.
- B. Do not over reach.
- C. Keep proper footing and balance at all times.
- D. Don't let the nose of the guide bar contact a log, branch, ground or other obstruction.
- E. Do not cut above shoulder height.
- F. Use devices such as low kickback chain, guide bar nose guards, chain brakes and special guide bars that reduce the risks associated with kickback.
- G. Only use replacement bars and chains specified by the manufacturer or the equivalent.
- H. There are no other replacement components for achieving kickback protection.
19. **POWER SUPPLY:** Connect the chain saw to correct voltage, that is, be sure that the voltage supplied is the same as that specified on the nameplate of the tool.

2-3. OTHER SAFETY PRECAUTIONS

1. DO NOT operate a chain saw that is damaged, improperly adjusted, or not completely and securely assembled. Be sure that the saw chain stops moving when the trigger is released.
2. DO NOT attempt operations beyond your capacity or experience.
3. DO NOT operate a chain saw with one hand! Serious injury to the operator, helpers, or bystanders may result from one-handed operation. A chain saw is intended for two-handed use.
4. TO REDUCE potential for electric shock, do not operate the saw on wet or slippery surfaces, or during snow storms, rain storms, and other adverse weather conditions.
5. Keep the handles dry, clean, and free of oil or grease.
6. DO NOT allow dirt, debris or sawdust to build up on the motor or outside air vents.
7. Follow the manufacturer's sharpening and maintenance instructions for the saw chain.
8. Cut at high motor speeds.
9. Operation of a chain saw should be restricted to mature, properly instructed individuals.
10. Your chain saw is intended for occasional homeowner use. It is not made for continuous heavy duty use.
11. DO NOT FORCE a small saw to do a job requiring a heavier duty unit.
12. **EXAMINE THE ELECTRICAL SWITCHES.** Do not use the chain saw if the switches do not properly turn on and off. Do not attempt to make any repairs to the electric switches. Take your saw to a Poulan Authorized Service Center.
13. **MAINTAIN EXTENSION CORDS.** Inspect the extension cords periodically and replace if damaged. Only use power cords that are suitably marked for outdoor use.

14. DO NOT OPERATE YOUR CHAIN SAW near or around flammable liquids or gases, whether in or out of doors. An explosion and/or fire may result.
 15. All chain saw service, other than the items listed in the user manual safety and maintenance instructions, should be performed by competent chain saw personnel. Do not attempt to repair it yourself; there are no user serviceable parts inside.
 16. NEVER REMOVE, modify or make inoperative any safety device furnished with your unit. The CHAIN BRAKE[®]/ Hand Guard is a major safety feature. The saw will not run when the CHAIN BRAKE[®] is tripped.
 17. This electric powered saw is intended for infrequent use by homeowner's, cottagers and campers, and for such general applications such as clearing, pruning, cutting firewood, etc. It is not intended for prolonged use. If the intended use involves prolonged periods of operation, this may cause circulatory problems in the user's hands due to vibration. It may be appropriate to use a saw having an anti-vibration feature.
 18. Safety clothing required by your safety organizations, government regulations, or your employer should be used; otherwise, snug fitting clothing, safety footwear, safety chaps and hand and ear protection should be worn.
 19. When felling, keep at least two (2) tree lengths between yourself and your fellow workers.
5. Follow the instructions in your operator's manual for starting the chain saw and control the chain saw with a firm grip on both handles when it is in operation. Keep handles dry, clean, and free of oil.
 6. When transporting your chain saw, use the appropriate transportation covers, which should be available for the guide bar and saw chain.
 7. Never operate a chain saw that is damaged or improperly adjusted or that is not completely and securely assembled. Be sure that the saw chain stops moving when the power control system trigger is released. Never adjust the guide bar or saw chain when the motor is operating.
 8. Do not attempt a pruning or limbing operation in a standing tree unless specifically trained to do so.
 9. Guard against kickback. Kickback is the upward motion of the guide bar that occurs when the saw chain, at the nose of the guide bar, contacts an object. Kickback can lead to dangerous loss of control of the chain saw.
 10. A chain saw is intended for two-handed use. Serious injury to the operator, helpers, and/or bystanders could result from one-handed operation.
 11. See section 1-6 for symbol definitions, page 14.
 12. When carrying a chain saw with the motor running, engage the chain brake.
 13. Keep other persons or animals a safe distance away from a running chain saw or the area where a tree is being felled.
 14. Use extreme caution when cutting small brush and saplings because slender material can catch the saw chain and be whipped toward you.
 15. When cutting a limb that is under tension or compression, be alert for springback.

2-4. GENERAL SAFETY PRECAUTIONS FOR CHAIN SAW USERS

1. Fatigue causes carelessness. Be more cautious before rest periods and towards the end of your shift.
2. Personal protective clothing required by your safety organizations, government regulations, or your employer should be used. At all times when using a chain saw, snug-fitting clothing, safety chaps protective eye wear, safety footwear, and hand, leg, and hearing protection should be worn.
3. When felling, keep at least two (2) tree lengths away from your fellow workers.
4. Plan your work, ensuring an obstacle-free work area and, in the case of felling, at least one escape path from the falling tree.

2-5. MORE ABOUT KICKBACK WARNING:

DANGER! BEWARE OF KICKBACK! Kickback can lead to dangerous loss of control of the chain saw and result in serious or fatal injury to the saw operator or to anyone standing close by. Always be alert because rotational kickback and pinch kickback are major chain saw operational dangers and the leading cause of most accidents.

BEWARE OF:
ROTATIONAL KICKBACK (Figure 2-5A)
 A = Kickback path
 B = Kickback reaction zone

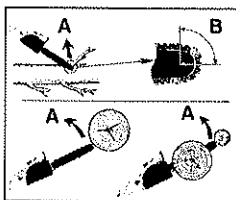

2-5A

THE PUSH (PINCH-KICKBACK) AND PULL REACTIONS (Figure 2-5B)
 A = Pull
 B = Solid objects
 C = Push

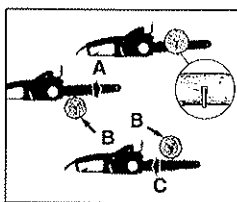

2-5B

KICKBACK may occur when the NOSE or TIP of the guide bar touches an object, or when wood closes in and pinches the saw chain in the cut.

Tip contact in some cases may cause a lightening-fast reverse reaction, kicking the guide bar up and back toward the operator.

PINCHING the saw chain along the BOTTOM of the guide bar may PULL the saw forward, away from the operator. (See Fig. 2-5B "A")

PINCHING the saw chain along the TOP of the guide bar may PUSH the guide bar rapidly back toward the operator (See Fig. 2-5B "C").

Any of these reactions may cause you to lose control of the saw, which could result in serious personal injury.

2-6. IDENTIFICATION OF SAFETY SYMBOLS



WARNING! This chain saw can be dangerous, careless or improper use can cause serious or even fatal injury.



Read and understand the instruction manual before using the chain saw.



Double insulated - When servicing use only identical replacement parts. Replace damaged cord immediately.



To reduce shock hazard, do not expose unit to water or operate on wet ground.



Contact of the guide bar tip with any object should be avoided. Tip contact may cause the guide bar to move suddenly upward and backward, which may cause serious injury.



Always use both hands when operating the chain saw.



There may be other replacement components for achieving Kickback protection.



Hearing protection should be worn.

3 - ASSEMBLY INSTRUCTIONS

3-1. INTRODUCTION

This unit is designed for occasional homeowner use and should not be used for commercial purposes or subjected to heavy continuous use.

Your new chain saw can be used for a variety of projects such as cutting firewood, making fence posts, felling small trees, limbing, pruning at ground level, and light carpentry. Cut only wood or wood products with your saw.

3-2. ASSEMBLY REQUIREMENTS

Your new chain saw will require adjustment of chain and filling the oil tank with lubricating oil before the unit is ready for operation. Do not start the saw motor until the unit is properly prepared. Read all instructions carefully. Do not install any other size bar and chain than what is recommended for your model.

3-3. GUIDE BAR / SAW CHAIN INSTALLATION

CAUTION

Disconnect the chain saw from power source before checking or adjusting the chain saw tension.

TO INSTALL GUIDE BAR & SAW CHAIN:

These instructions are for replacing a bar. The unit is fully assembled when shipped. **NOTE:** Always wear heavy gloves when handling the saw chain.

1. Place power unit on flat surface.
2. Loosen knob (B) slightly by turning knob counter-clockwise and then turn the chain tension ring (C) counter-clockwise to relief chain tension. To remove the sprocket cover (A), turn knob (B) counter-clockwise. (Fig. 3-3A)
3. Remove saw chain from around the guide bar and the sprocket. Slide the guide bar, with tension plate (D) attached, from the unit. (Fig. 3-3B)
4. Remove screw (C) from the tension plate (D) to remove it from the old bar and attach it to the new bar. (Fig. 3-3B)
5. Spread the chain out with the cutting edges (E) of the chain pointing in the DIRECTION OF ROTATION. (Fig. 3-3C)

6. To fit the chain links into the groove on the guide bar, turn the tension plate (D) counter-clockwise to the end. Install the chain and bar on the power unit, turn the tension plate (D) clockwise and then put the side cover (A) on. (Fig. 3-3D)
7. Turn the knob clockwise, adjust the chain tension ring (F) and then tighten the knob. After running the chain saw about for one (1) hour - retension the chain, if needed, based on figure 3-4A.

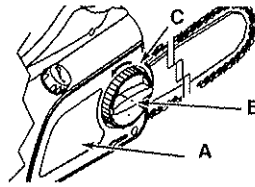

3-3A

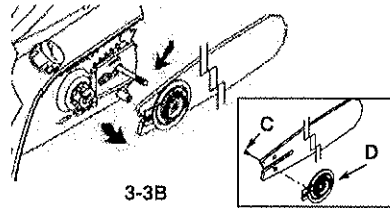

3-3B

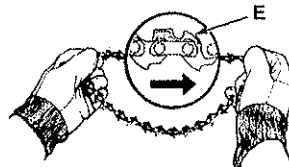

3-3C

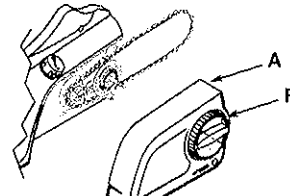

3-3D

3-4. SAW CHAIN TENSION ADJUSTMENT

Proper tension of the saw chain is extremely important and must be checked before starting, as well as during, any cutting operation. Taking the time to make needed adjustments to the saw chain will result in improved cutting performance and prolonged chain life.

NOTE: A new chain and bar will need readjustment after as few as 5 cuts. This is normal during the break-in period, and the interval between future adjustments will lengthen quickly (Figure 3-4A).

CAUTION

If a chain is TOO LOOSE or TOO TIGHT, the bar chain and saw bearings will wear more rapidly. Study Figure 3-4A for information concerning correct cold tension (A), correct warm tension (B), and as a guide for when saw chain needs adjustment (C).

TO ADJUST SAW CHAIN TENSION:

With no tools system - wear gloves while tensioning chain.

NOTE: Make sure the CHAIN BRAKE® is disengaged. Disengage the CHAIN BRAKE® (D) by pulling it backward (Figure 3-4B).

1. Tensioning the chain is easy. Turn bar bolt knob (E) counter clock wise. Then turn ring (F) counter clock wise to loosen chain or clock wise to tighten chain. (Fig. 3-4C)
2. After adjustment and while wearing heavy duty work gloves, move the saw chain back and forth on the guide bar to be sure the chain moves freely and is in proper mesh with sprocket.

NOTE: If the chain is difficult to rotate or if it binds on the guide bar, too much tension has been applied and must be adjusted as described in step 1.

3. While tensioning the chain. Hold tip of the bar up and then tighten the bar bolt knob (E).

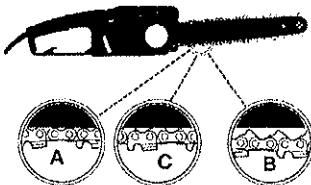

3-4A



3-4B

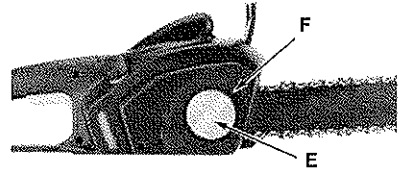

3-4C

3-5. FILLING OIL TANK

Using a funnel, fill oil tank with Genuine Factory Parts Chain, Bar and Sprocket oil. Wipe up any spills. Make sure no dirt gets into the oil tank.

The saw chain requires lubrication while in use to minimize friction with the guide bar. The oil tank holds 4.5 ozs of oil, enough to lubricate the chain for 12-15 minutes of sawing.

We recommend using Genuine Factory Parts Chain, Bar and Sprocket Oil, which contains additives to reduce friction wear and reduce resin residue formations.

CAUTION

The oil tank level should be frequently checked during operation to avoid starving the bar and chain of lubrication.

NOTE: Your chain saw is equipped with an Automatic Oiler system and is the ONLY source of lubrication for the bar and chain (Figure 3-5A).

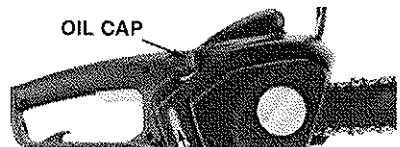

OIL TANK INSPECTION SLOT

3-5A

3-6. SELECTING THE PROPER EXTENSION CORD FOR YOUR SAW MODEL

Minimum Gauge Wire					
Saw Model	Ampere Rating	Volts AC	Length of Power Cord		
			25 ft. / 7.5m	50 ft. / 15m	100 ft. / 30m
PLN3516F	13.5	120	16 Gauge	16 Gauge	14 Gauge

1. The extension cord is to be for outdoor use, marked with the suffix W or W-A following the cord type designation, for example - SJTW or SJTW-A.
2. Make sure the extension cord is in good condition before using.
3. Keep the cord away from the cutting area and to position cord so that it will not be caught on branches, and the like, during cutting.

4 - OPERATING INSTRUCTIONS

4-1. TO START SAW

1. Make sure the CHAIN BRAKE® IS DISENGAGED. The motor will not start if the CHAIN BRAKE® is in the ENGAGED position. Disengage the CHAIN BRAKE® by pulling backward toward the motor (Figure 4-1A).

WARNING

Ensure the extension cord is of the proper size and type for your saw.

2. An extension cord retainer (A) (Fig. 4-1B) is built into the rear handle that prevents the extension cord from pulling out of the handle. To use this feature, simply double the extension cord, about a foot from the end, and insert it through the hole at the end of the handle. Hook the loop formed by doubling the cord over the tab. Gently tug on the cord to ensure that it is firmly retained in the saws handle. Plug the receptacle end of the extension cord into the tool's power supply cord.

WARNING

Make sure the extension cord does not come in contact with the guide bar and saw chain.

3. Grip the saw with both hands, left hand holding the front handle (DO NOT HOLD CHAIN BRAKE®) and the right hand holding the rear handle. Thumbs and fingers should encircle both handles (Figure 4-1C).
4. With your RIGHT THUMB, depress the LOCK/OFF button (C) on the top of the rear handle, and at the same time squeeze the trigger. To stop the saw, release the trigger (Figure 4-1D).

NOTE: It is not necessary to maintain pressure on the LOCK/OFF button once the trigger is squeezed and the motor is

running. The LOCK/OFF button is a safety device to avoid accidental starting.



4-1A

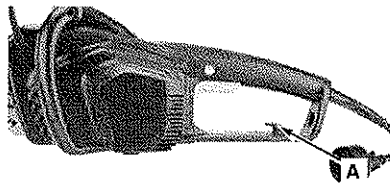

4-1B



4-1C



4-1D

4-2. TO STOP MOTOR

The saw motor will automatically stop when the trigger is released. The LOCK/OFF button will have to be depressed and the trigger squeezed to restart the motor.

4-3. CHAIN AND BAR LUBRICATION

Adequate lubrication of the saw chain during cutting operations is essential to minimize friction with the guide bar.

Your chain saw is equipped with an automatic oiler system.

The oiler automatically delivers the proper amount of oil to the bar and chain. There is no flow adjustment.

The oil tank level can be checked in the inspection slot (A) provided on the right side of the saw. Tank is full when oil is at the top of the slot (Figure 4-3A).

CAUTION

Never starve the bar and chain of lubrication oil. Running the saw DRY or with TOO LITTLE OIL will decrease cutting efficiency, shorten chain saw life, and cause rapid dulling of the chain and excessive wear of the bar from overheating. Too little is evidenced by smoke or bar discoloration.

NOTE: The saw chain stretches during use, particularly when it is new, and occasional adjustment will be needed. A new chain requires more frequent adjustment during the break-in period. This is normal. See Section 3-4, Saw Chain Tension Adjustment instructions.

WARNING / CAUTION

A loose chain can jump off the bar while you are cutting, as well as wear the bar and chain. A chain that is too tight can damage the saw. Either situation, chain too loose or too tight, could cause serious personal injury.

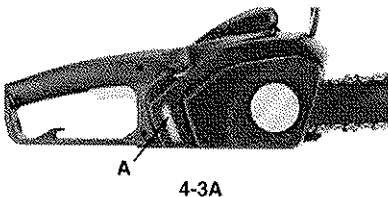

4-3A

4-4. CHAIN BRAKE® / HAND GUARD

This Poulan chain saw is equipped with chain brake/hand guard.

The Hand Guard protects your left hand in the event it slips off the front handle.

The CHAIN BRAKE® is a safety feature which is activated if pressure is applied

against the guard or when, in the event of kickback, the operator's hand strikes the lever. When the CHAIN BRAKE® is activated, chain movement abruptly stops and the power supply to the motor is immediately cut off.

The purpose of the CHAIN BRAKE® is to reduce the possibility of injury due to kickback. The CHAIN BRAKE® cannot, however, provide the measure of intended protection if the saw is carelessly operated. The CHAIN BRAKE® is disengaged (chain can move) when the brake is pulled back and locked. This is the normal running position (Figure 4-4A).

The CHAIN BRAKE® is engaged (chain cannot move) when the brake is in forward position (Figure 4-4B).

NOTE: The motor will not start if the CHAIN BRAKE® is in the engaged position.

CAUTION

The CHAIN BRAKE® should not be used for starting and stopping the saw during normal operation.

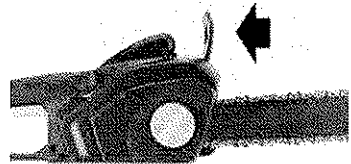

4-4A

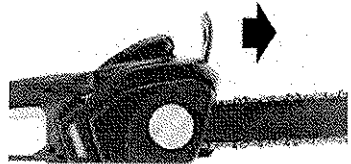

4-4B

CHAIN BRAKE® TEST

Before cutting with your saw, the CHAIN BRAKE® should be tested as follows:

- Make sure the CHAIN BRAKE® is disengaged (Figure 4-4A).
- Place the saw on a firm, flat, dry surface that is clear of any debris. Do not let the saw come in contact with any objects.
- Plug the unit into the power source.
- Grasp the front handle (not the CHAIN BRAKE®/Hand Guard Lever) with your left hand. Thumb and fingers should encircle the handle.

- E. Grasp the rear handle with your right hand. Thumb and fingers should encircle the handle.
- F. Depress the LOCK/OFF button with your right thumb. Squeeze the trigger with your index finger. (See Fig.4-1D).
- G. While the motor is running, activate the CHAIN BRAKE® by rolling your left hand forward against the lever.
- H. Chain and motor should stop abruptly.

WARNING

If the chain and motor fail to stop when the CHAIN BRAKE® is engaged, take the saw to the nearest Authorized Service Center. Do not use the saw if the CHAIN BRAKE® is not in proper working order.

4-5. EXTENSION CORDS

When using an electric chain saw, plug it into the extension cord only when you are ready to cut wood. Connect the extension cord to a 110/120 voltage outlet. see chart 3-6.

CAUTION

A cord that is hot to the touch is overloaded.

WARNING

Do not operate your chain saw in a wet or damp environment. Do not expose the saw to rain, snow or sleet. Moisture will cause short circuits. Replace or repair any

damaged or frayed extension cords before using your saw. Keep the cord away from the cutting area and position the cord so that it will not be caught on branches or other objects during cutting.

DOUBLE INSULATION ☐ WHEN SERVICING USE ONLY IDENTICAL REPLACEMENT PARTS

Do not use if the cord or plug is damaged. Your appliance is double insulated to help protect against electric shock.

Double insulation construction consists of two(2) separate "layers" of electrical insulation.

Appliances built with this insulation system are not intended to be grounded. As a result, the extension cord used with your appliance can be plugged into any conventional 120 volt electrical outlet. Normal safety precautions must be observed when operating an electrical appliance. The double insulation system is only for added protection against injury resulting from a possible internal electrical insulation failure.

WARNING

Your double insulated appliance has no serviceable parts inside. Do not attempt to repair it yourself. For service information, contact the Poulan Product Service Department toll-free number listed on the back cover of this manual.

5 - GENERAL CUTTING INSTRUCTIONS

5-1. FELLING

Felling is the term for cutting down a tree. Small trees up to 6-7 inches (15-18cm) in diameter are usually cut in a single cut. Larger trees require notch cuts. Notch cuts determine the direction the tree will fall.

FELLING A TREE:

WARNING

A retreat path (A) should be planned and cleared as necessary before cuts are started. The retreat path should extend back and diagonally to the rear of the expected line of fall, as illustrated in Figure 5-1A.

CAUTION

If felling a tree on sloping ground, the chain saw operator should keep on the uphill side of the terrain, as the tree is likely to roll or slide downhill after it is felled.

NOTE: Direction of fall (B) is controlled by the notching cut. Before any cuts are made, consider the location of larger branches and natural lean of the tree to determine the way the tree will fall.

WARNING

Do not cut down a tree during high or changing winds or if there is a danger to property. Consult a tree professional. Do not cut down a tree if there is a danger of striking utility wires; notify the utility company before making any cuts.

GENERAL GUIDELINES FOR FELLING TREES:

Normally felling consists of two (2) main cutting operations, notching (C) and making the felling cut (D). Start making the upper notch cut (C) on the side of the tree facing the felling direction (E). Be sure you don't make the lower cut too deep into the trunk.

The notch (C) should be deep enough to create a hinge (F) of sufficient width and strength. The notch should be wide enough to direct the fall of the tree for as long as possible.

WARNING

Never walk in front of a tree that has been notched.

Make the felling cut (D) from the other side of the tree and 1.5 - 2.0 inches (3-5 cm) above the edge of the notch (C) (Figure 5-1B).

Never saw completely through the trunk. Always leave a hinge. The hinge guides the tree. If the trunk is completely cut through, control over the felling direction is lost.

Insert a wedge or felling lever in the cut well before the tree becomes unstable and starts to move. This will prevent the guide bar from binding in the felling cut if you have misjudged the falling direction. Make sure no bystanders have entered the range of the falling tree before you push it over.

WARNING

Before making the final cut, always recheck the area for bystanders, animals or obstacles.

FELLING CUT:

1. Use wooden or plastic wedges (G) to prevent binding the bar or chain (H) in the cut. Wedges also control felling (Figure 5-1C).
2. When diameter of wood being cut is greater than the bar length, make 2 cuts as shown (Figure 5-1D).

WARNING

As the felling cut gets close to the hinge, the tree should begin to fall. When tree begins to fall, remove saw from cut, stop engine, put chain saw down, and leave area along retreat path (Figure 5-1A).

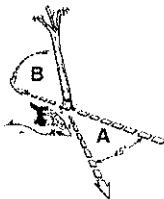

5-1A

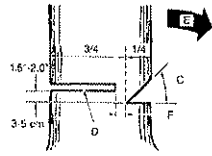

5-1B

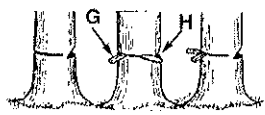

5-1C



5-1D

5-2. LIMBING

Limbing a tree is the process of removing the branches from a fallen tree. Do not remove supporting limbs (A) until after the log is bucked (cut) into lengths (Figure 5-2A). Branches under tension should be cut from the bottom up to avoid binding the chain saw.

WARNING

Never cut tree limbs while standing on tree trunk.



5-2A

5-3. BUCKING

Bucking is cutting a fallen log into lengths. Make sure you have a good footing and stand uphill of the log when cutting on sloping ground. If possible, the log should be supported so that the end to be cut off is not resting on the ground. If the log is supported at both ends and you must cut in the middle, make a downward cut halfway through the log and then make the undercut. This will prevent the log from pinching the bar and chain. Be careful that the chain does not cut into the ground when bucking as this causes rapid dulling of the chain.

When bucking on a slope, always stand on the uphill side.

1. Log supported along entire length: Cut from top (overbuck), being careful to avoid cutting into the ground (Figure 5-3A).
2. Log supported on 1 end: First, cut from bottom (underbuck) 1/3 diameter of log to avoid splintering. Second, cut from above (overbuck) to meet first cut and avoid pinching (Figure 5-3B).
3. Log supported on both ends: First, overbuck 1/3 diameter of log to avoid splintering. Second, underbuck to meet first cut and avoid pinching (Figure 5-3C).

NOTE: The best way to hold a log while bucking is to use a sawhorse. When this is not possible, the log should be raised and supported by the limb stumps or by using supporting logs. Be sure the log being cut is securely supported.



5-3A



5-3B



5-3C

5-4. BUCKING USING A SAWHORSE

For personal safety and ease of cutting, the correct position for vertical bucking is essential (Figure 5-4A).

VERTICAL CUTTING:

- A. Hold the saw firmly with both hands and keep the saw to the right of your body while cutting.
- B. Keep the left arm as straight as possible.
- C. Keep weight on both feet.

CAUTION

While the saw is cutting, be sure the chain and bar are being properly lubricated.

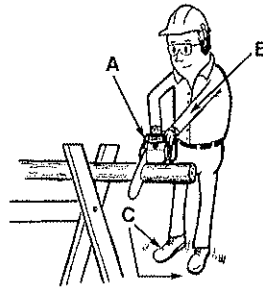

5-4A

6 - BAR / CHAIN MAINTENANCE

6-1. GUIDE BAR MAINTENANCE

WARNING

Ensure that the power cord is disconnected before performing any maintenance on your saw.

Proper maintenance of the guide bar, as explained in this section, is essential to keep your saw in good working order.

SPROCKET TIP LUBRICATION:

(For units supplied with sprocket tip guide bars only.)

CAUTION Ⓢ

Failure to lubricate the guide bar sprocket tip as explained below will result in poor performance and seizure, voiding the manufacturer's warranty.

Lubrication of the sprocket tip is recommended after each saw use. Always thoroughly clean the guide bar sprocket tip before lubrication.

Tool for lubrication: Poulan Lube Gun (disposable)

This grease gun is designed to fit the small lubrication point on the guide bar.

The disposable Lube Gun is packed with grease. For information on where to purchase a lube gun, contact the Poulan Product Service Department toll-free number listed on the back cover of this manual.

TO LUBRICATE SPROCKET TIP:

WARNING

Wear heavy duty work gloves when performing this application to reduce risk of personal injury.

1. Unplug the chain saw from the power source.

NOTE: It is not necessary to remove the saw chain to lubricate the guide bar sprocket tip. Lubrication can be done on the job.

2. Clean the guide bar sprocket tip.
3. Using disposable Lube gun, insert tip of lube gun into the lubrication hole and inject grease until it appears at the outside edge of the sprocket tip (Figure 6-1A).
4. Make sure that the CHAIN BRAKE® is deactivated. Rotate the saw chain by hand. Repeat the lubrication procedure until the entire sprocket tip has been greased.

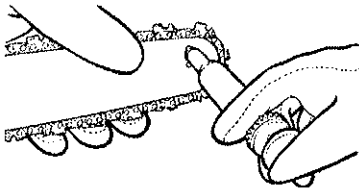

6-1A

GUIDE BAR MAINTENANCE

Most guide bar problems can be prevented merely by keeping the chain saw well maintained.

Incorrect filing and non-uniform cutter and depth gauge settings cause most guide bar problems, primarily resulting in uneven bar wear. As the bar wears unevenly, the rails widen, which may cause chain clatter and difficulty in making straight cuts.

Insufficient guide bar lubrication and operating the saw with a chain that is TOO TIGHT will contribute to rapid bar wear (see Section 6-2).

To help minimize bar wear, the following guide bar maintenance is recommended.

BAR WEAR - Turn guide bar frequently at regular intervals (for example, after 5 hours of use), to ensure even wear on top and bottom of bar.

BAR GROOVES - Bar grooves (or rails which support and carry the chain) should be cleaned if the saw has been heavily used or if the saw chain appears dirty. Rails should always be cleaned every time the saw chain is removed.

OIL PASSAGES - Oil passages at bar pad should be cleaned to ensure proper lubrication of the bar and chain during operation. This can be done using a soft wire small enough to insert into the oil discharge hole.

NOTE: The condition of the oil passages can be easily checked. If the passages are clear, the chain will automatically give off a spray of oil within seconds of starting the saw. Your saw is equipped with an automatic oiler system.

TO CLEAN GUIDE BAR RAILS:

1. Remove sprocket cover, bar and chain. (see Section 3-3)
2. Using a screwdriver, putty knife, wire brush or other similar instrument, clear residue from the rails on the guide bar. This will keep the oil passages open to provide proper lubrication to the bar and chain (Figure 6-1B).
3. Reinstall the bar, chain, sprocket cover and bar bolt knob. (See Section 3-3).

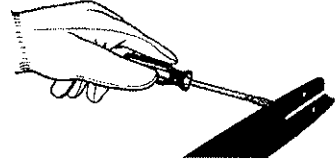

6-1B

6-2. CHAIN MAINTENANCE INSTRUCTIONS

WARNING

Unless you have experience and specialized training for dealing with kickback (see Safety Precautions), always use a low-kickback saw chain, which significantly reduces the danger of kickback. Low-kickback saw chain does not completely eliminate kickback. A low-kickback or "safety chain", should never be regarded as total protection against injury.

A low-kickback saw chain should always be used in conjunction with other kickback protection devices such as the CHAIN BRAKE®/Hand Guard furnished with your unit.

Always use a replacement saw chain designed as "low-kickback" or a saw chain which meets the low-kickback performance requirements of ANSI (American National Standards Institute).

A standard saw chain (a chain which does not have the kickback reducing guard links) should only be used by an experienced professional chain saw operator.

WHAT IS A LOW-KICKBACK SAW CHAIN?

A low-kickback saw chain is a chain which has met the kickback performance requirements of ANSI B175.1.

By keeping the CHAIN BRAKE® and saw chain in good working condition and correctly serviced as recommended in this manual, you will be able to maintain the safety system of your chain saw over the life of the product.

WARNING

Never remove, modify or make inoperative any safety device furnished with your unit. The CHAIN BRAKE®/Hand Guard and low-kickback saw chain are major safety features provided for your protection.

WARNING

Always wear heavy duty protection work gloves and disconnect the extension cord when working on the saw chain.

CHAIN TENSION:

Check the chain tension frequently and adjust as often as necessary to keep the chain snug on the bar, but loose enough to be pulled around by hand. (See Section 3-4, Saw Chain Tension Adjustment).

BREAKING IN A NEW SAW CHAIN

A new chain and bar will need readjustment after as few as five (5) cuts. This is normal during the break-in period, and the interval between future adjustments will begin to lengthen quickly.

Over a period of time, however, the moving parts of the saw chain will become worn, resulting in what is called CHAIN STRETCH. This is normal. When it is no longer possible to obtain correct chain tension adjustment, a link will have to be removed to shorten the chain. See your nearest Authorized Service Center to have this repair performed.

WARNING / CAUTION

Never have more than three (3) links removed from a loop of chain. This could cause damage to the sprocket.

CHAIN LUBRICATION:

Always make sure the automatic oiler system is working properly. Keep the oil tank filled with Genuine Factory Parts Chain, Bar and Sprocket Oil. Adequate lubrication of the bar and chain during cutting operations is essential to minimize friction with the guide bar. Never starve the bar and chain of lubricating oil. Running the saw dry or with too little oil will decrease rapid cutting efficiency, shorten saw chain life, cause rapid dulling of the chain, and lead to excessive wear of the bar from overheating. Too little oil is evidenced by smoke or bar discoloration.

7 - PREVENTIVE MAINTENANCE

7-1. PREVENTIVE MAINTENANCE

WARNING

SERVICING A DOUBLE INSULATED APPLIANCE

In this double insulated appliance, 2 systems of insulation, instead of grounding, are provided. No grounding means is provided on a double insulated appliance, nor should a means for grounding be added to the appliance. No serviceable parts are inside. A double insulated appliance is marked with the words, "DOUBLE INSULATION" or "DOUBLE INSULATED". The symbol  may also be marked on the appliance.

1. Place switch in OFF position and unplug the power supply before the appliance is serviced, cleaned, or maintenance is performed.
2. Keep the air intake clean and air vents free of debris to avoid overheating the motor.
3. Clean with a damp sponge and mild soap. Do not squirt with a water hose or douse with water or other liquids.
4. Inspect the saw chain for proper tension before each use and frequently during cutting. Sharpen as required.
5. Clean the guide bar and bar pad to ensure free path for oil.
6. Turn the bar over after each use to achieve even wear.
7. No motor lubrication is necessary. The motor is equipped with lifetime lubricated bearings.

8. If the saw does not operate, turn switch to OFF position and disconnect the extension cord, first from the power supply, then from the saw. Check the power supply for blown fuses or tripped circuit breakers. If it still does not

operate, contact the Poulan Product Service Department, through the toll-free number listed on the back cover of this manual, for service information. Do not attempt to repair it yourself. No serviceable parts are inside.

7-2. CHAIN REPLACEMENT INFORMATION

Drive Links	Bar		Chain			
	P/N	Length	P/N	Length	Gauge	Pitch
55 DL	966-051301	16"	966-051603	16"	0.05	3/8"

There may be other quality equivalent replacement components for achieving kickback protection.

8 - LIMITED WARRANTY

Poulan, a division of Husqvarna Consumer Outdoor Products N.A., Inc., warrants to the original consumer purchaser that each new **Poulan** brand electric or cordless product is free from defects in material and workmanship and agrees to repair or replace under this warranty any defective **Poulan** brand electric product within one (1) year from the original date of purchase. If your **Poulan** brand electric or cordless product should fail within the limited warranty period, you may return it in complete condition, prepaid, with proof of purchase to the dealer from whom it was purchased for repair or replacement at the option of **Poulan**.

This warranty is not transferable and does not cover damage or liability caused by improper handling, improper maintenance or alteration, or the use of accessories and/or attachments not specifically recommended by **Poulan** for this product. This warranty does not cover parts that will wear and require replacement with reasonable use during the warranty period. This warranty does not cover pre-delivery setup or normal adjustments explained in the instruction manual. Should you have any unanswered questions regarding this warranty, please contact:

Poulan, a division of Husqvarna
Consumer Outdoor Products N.A., Inc.
1030 Stevens Creek Road
Augusta, GA 30907
1-800-554-6723

In Canada, contact:

Poulan
850 Matheson Blvd. West
Mississauga, Ontario L5V 0B4

Giving the model number, serial number and date of purchase of your product and the name and address of the authorized dealer from whom it was purchased.

THIS WARRANTY GIVES YOU SPECIFIC LEGAL RIGHTS, AND YOU MAY HAVE OTHER RIGHTS WHICH VARY FROM STATE TO STATE.

NO CLAIMS FOR CONSEQUENTIAL OR OTHER DAMAGES WILL BE ALLOWED, AND THERE ARE NO OTHER EXPRESS WARRANTIES EXCEPT THOSE EXPRESSLY STIPULATED HEREIN.

SOME STATES DO NOT ALLOW LIMITATIONS ON HOW LONG AN IMPLIED WARRANTY LASTS OR THE EXCLUSION OR LIMITATIONS OF INCIDENTAL OR CONSEQUENTIAL DAMAGES, SO THE ABOVE LIMITATIONS OR EXCLUSION MAY NOT APPLY TO YOU.

This is a limited warranty within the meaning of that term as defined in the Magnuson-Moss Act of 1975.

The policy of **Poulan** is to continuously improve its products. Therefore, **Poulan** reserves the right to change, modify, or discontinue models, designs, specifications, and accessories of all products at any time without notice or obligation to any purchaser.