

JVC

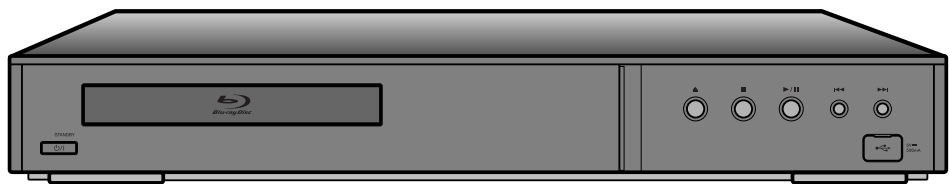

Blu-ray Disc Player

XV-BP1



INSTRUCTIONS

**CAUTION: TO REDUCE THE RISK
OF ELECTRIC SHOCK
DO NOT REMOVE COVER (OR BACK)
NO USER-SERVICEABLE PARTS INSIDE
REFER SERVICING TO QUALIFIED SERVICE
PERSONNEL.**

WARNING: Do not install this equipment in a confined space such as a book case or similar unit.

CAUTION:

Do not block any ventilation openings. Install in accordance with the manufacturer's instructions. Slots and openings in the cabinet are provided for ventilation and to ensure reliable operation of the product and to protect it from over heating.

The openings shall never be blocked by placing the product on a bed, sofa, rug or other similar surface. This product shall not be placed in a built-in installation such as a bookcase or rack unless proper ventilation is provided or the manufacturer's instruction have been adhered to.

IMPORTANT FOR LASER PRODUCTS

1. CLASS 1 LASER PRODUCT
2. **CAUTION:** Do not open the top cover or cabinet. There are no user serviceable parts inside the unit; leave all servicing to qualified service personnel.
3. **CAUTION:** CLASS 3B VISIBLE AND INVISIBLE LASER RADIATION WHEN OPEN. AVOID EXPOSURE TO THE BEAM.
4. REPRODUCTION OF LABEL: CAUTION LABEL, PLACED INSIDE THE UNIT.

CAUTION	CLASS 3B VISIBLE AND INVISIBLE LASER RADIATION WHEN OPEN. AVOID EXPOSURE TO THE BEAM.
ADVARSEL	KLASSE 3B SYNLIG OG USYNLIG LASERSTRÅLING VED ÅBNING. UNDGÅ UDSAETTELSE FOR STRÅLING.
ADVARSEL	KLASSE 3B SYNLIG OG USYNLIG LASERTSRÅLING NÅR DEKSEL ÅPENS. UNNGÅ EKSPONERING FOR STRÅLEN.
VARNING	KLASS 3B SYNLIG OCH OSYNLIG LASERSTRÅLNING NÅR DENNA DEL ÄR ÖPPNAD. STRÅLEN ÄR FARLIG.
VARO	AVATTAESSA OLET ALTTIINA LUOKAN 3B NÄKYVÄÄ JA NÄKYMÄTÖNTÄ LASERSÄTEILYLLLE VARO ALTISTUMISTA SÄTEELLE.
VORSICHT	SICHTBARE UND UNSICHTBARE LASERSTRAHLUNG KLASSE 3B, WENN ABDECKUNG GEÖFFNET. NICHT DEM STRAHL AUSSETZEN.

CAUTION concerning the Power Cord

Most appliances recommend they be placed upon a dedicated circuit;

That is, a single outlet circuit which powers only that appliance and has no additional outlets or branch circuits. Check the specification page of this owner's manual to be certain.

Do not overload wall outlets. Overloaded wall outlets, loose or damaged wall outlets, extension cords, frayed power cords, or damaged or cracked wire insulation are dangerous. Any of these conditions could result in electric shock or fire. Periodically examine the cord of your appliance, and if its appearance indicates damage or deterioration, unplug it, discontinue use of the appliance, and have the cord replaced with an exact replacement part by an authorized servicer.

Protect the power cord from physical or mechanical abuse, such as being twisted, kinked, pinched, closed in a door, or walked upon. Pay particular attention to plugs, wall outlets, and the point where the cord exits the appliance.

To disconnect power from the mains, pull out the mains cord plug. When installing the product, ensure that the plug is easily accessible.



As an ENERGY STAR® Partner, JVC has determined that this product or product models meet the ENERGY STAR® guidelines for energy efficiency.

ATTENTION:

- The STANDBY/ON button does not completely shut off mains power from the unit, but switches operating current on and off.
- When moving the product, press STANDBY/ON to turn off the power, and wait at least 30 seconds before unplugging the power cord. Then, wait at least 2 minutes before moving the product.
- When discarding batteries, environmental problems must be considered and the local rules or laws governing the disposal of these batteries must be followed strictly.

CAUTION

- Do not block the ventilation openings or holes. (If the ventilation openings or holes are blocked by a newspaper or cloth, etc., the heat may not be able to get out.)
- Do not place any naked flame sources, such as lighted candles, on the apparatus.
- When discarding batteries, environmental problems must be considered and local rules or laws governing the disposal of these batteries must be followed strictly.
- Do not expose this apparatus to rain, moisture, dripping or splashing and that no objects filled with liquids, such as vases, shall be placed on the apparatus.
- Battery shall not be exposed to excessive heat such as sunshine, fire or the like.

Notes on Copyrights

- Because AACS (Advanced Access Content System) is approved as content protection system for BD format, similar to use of CSS (Content Scramble System) for DVD format, certain restrictions are imposed on playback, analog signal output, etc., of AACS protected contents. The operation of this product and restrictions on this product may vary depending on your time of purchase as those restrictions may be adopted and/or changed by AACS after the production of this product.

Furthermore, BD-ROM Mark and BD+ are additionally used as content protection systems for BD format, which imposes certain restrictions including playback restrictions for BD-ROM Mark and/or BD+ protected contents. To obtain additional information on AACS, BD-ROM Mark, BD+, or this product, please contact an authorized Customer Service Center.

- Many BD-ROM/DVD discs are encoded with copy protection. Because of this, you should only connect your player directly to your TV, not to a VCR. Connecting to a VCR results in a distorted picture from copy-protected discs.
- This product incorporates copyright protection technology that is protected by U.S. patents and other intellectual property rights. Use of this copyright protection technology must be authorized by Macrovision, and is intended for home and other limited viewing uses only unless otherwise authorized by Macrovision. Reverse engineering or disassembly is prohibited.
- Under the U.S. Copyright laws and Copyright laws of other countries, unauthorized recording, use, display, distribution, or revision of television programs, videotapes, BD-ROM discs, DVDs, CDs and other materials may subject you to civil and/or criminal liability.

Licenses

Java and all Java-based trademarks and logos are trademarks or registered trademarks of Sun Microsystems, Inc. in the United States and other countries.

Manufactured under license from Dolby Laboratories. Dolby and the double-D symbol are trademarks of Dolby Laboratories.

Manufactured under license under U.S. Patent #: 5,451,942; 5,956,674; 5,974,380; 5,978,762; 6,487,535 & other U.S. and worldwide patents issued & pending. DTS is a registered trademark and the DTS logos, Symbol, DTS-HD and DTS-HD Advanced Digital Out are trademarks of DTS, Inc. © 1996-2008 DTS, Inc. All Rights Reserved.

HDMI, the HDMI logo and High-Definition Multimedia Interface are trademarks or registered trademarks of HDMI licensing LLC.

“BD-LIVE” logo is a trademark of Blu-ray Disc Association.

“DVD Logo” is a trademark of DVD Format/Logo Licensing Corporation.

“x.v.Color” is a trademark of Sony Corporation.

“Blu-ray Disc” is a trademark.

“BONUSVIEW” is trademark of Blu-ray Disc Association.

This product is licensed under the AVC patent portfolio license and VC-1 patent portfolio license for the personal and non-commercial use of a consumer to (i) encode video in compliance with the AVC Standard and VC-1 Standard (“AVC/VC-1 Video”) and/or (ii) decode AVC/VC-1 Video that was encoded by a consumer engaged in a personal and non-commercial activity and/or was obtained from a video provider licensed to provide AVC/VC-1 Video. No license is granted or shall be implied for any other use. Additional information may be obtained from MPEG LA, LLC. See <http://www.mpegla.com>.

“AVCHD” and the “AVCHD” logo are trademarks of Panasonic Corporation and Sony Corporation.

Contents

Introduction6-12

About the ∅ Symbol Display	6
Symbols Used in this Manual	6
Notes on Discs	6
Moisture Condensation	6
Handling the Unit	6
Playable Discs	7
Regional Code	7
BD-ROM Disc Features	8
Compatibility Notes	9
Certain System Requirements	9
Resetting the Player	9
Using a USB Flash Drive	10
Using the Home Menu	10
Front Panel	11
Rear Panel	11
Remote Control	12
Remote Control Operation	12

Installation and Setup13-23

HDMI connection	13
Connections to Your TV	14
Connecting to an Amplifier	15
Internet connection	16
Resolution Setting	17-18
Initial Settings	19
- General Operation	19
- [DISPLAY] Menu	19
- [LANGUAGE] Menu	20
- [AUDIO] Menu	20
- [LOCK] Menu (Parental Control)	21
- [NETWORK] Menu	22
- [OTHERS] Menu	23

Operations24-32

General playback features	24-25
If a disc menu screen is displayed	26
Enlarge the playback image	26
Time Search	26
Skip Search	26
Marker Search	26
Watching from a different angle	26
Last Scene Memory	26
Using Color (R, G, B, Y) Buttons	27
Screen Saver	27
Displaying Disc Information On-Screen	27
Enjoying BD-LIVE™ or BONUS VIEW™ in BD-Video	28
Playing a DVD VR Format Disc	29
Playing a MPEG4 movie file	30
Playing an Audio CD or MP3/WMA files	31
Viewing a Photo file	32

Reference33-37

Language Codes	33
Area Codes	33
Troubleshooting	34
Specifications	35
This unit's Audio Output Specifications	36
Open source software notice	37

Introduction

To ensure proper use of this product, please read this owner's manual carefully and retain for future reference.

This manual provides information on the operation and maintenance of your player. Should the unit require service, contact an authorized service location.

About the Symbol Display

"  " may appear on your TV display during operation and indicates that the function explained in this owner's manual is not available on that specific media.

Symbols Used in this Manual

Note:

Indicates special notes and operating features.

Tip:

Indicates tips and hints for making the task easier.

A section whose title has one of the following symbols are applicable only to the disc represented by the symbol.

ALL All discs listed below

- BD** BD-ROM disc
- DVD** DVD-Video, DVD-R/RW, +R/+RW in Video mode or VR mode and finalized
- AVCHD** DVD-R/RW, +R/+RW in AVCHD format
- MPEG4** MPEG4 files
- ACD** Audio CDs
- MP3** MP3 files
- WMA** WMA files
- PHOTO** Photo files

Notes on Discs

Handling Discs

Do not touch the playback side of the disc. Hold the disc by the edges so that fingerprints do not get on the surface. Never stick paper or tape on the disc.

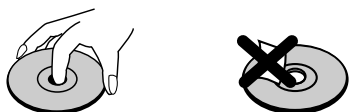

Storing Discs

After playing, store the disc in its case. Do not expose the disc to direct sunlight or sources of heat and never leave it in a parked car exposed to direct sunlight.

Cleaning Discs

Fingerprints and dust on the disc can cause poor picture quality and sound distortion. Before playing, clean the disc with a clean cloth. Wipe the disc from the center out.

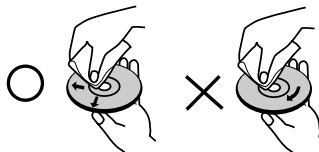

Do not use strong solvents such as alcohol, benzene, thinner, commercially available cleaners, or anti-static spray intended for older vinyl records.

Moisture Condensation

Never operate this product immediately after moving it from a cold location to a warm location. Leave it for two or three hours without operating it. If you use this product in such a situation, it may damage discs and internal parts.

Handling the Unit

When shipping the unit

Please save the original shipping carton and packing materials. If you need to ship the unit, for maximum protection, re-pack the unit as it was originally packed at the factory.

Keeping the exterior surfaces clean

- Do not use volatile liquids such as insecticide spray near the unit.
- Wiping with strong pressure may damage the surface.
- Do not leave rubber or plastic products in contact with the unit for a long period of time.

Cleaning the unit

To clean the player, use a soft, dry cloth. If the surfaces are extremely dirty, use a soft cloth lightly moistened with a mild detergent solution. Do not use strong solvents such as alcohol, benzene, or thinner, as these might damage the surface of the unit.

Maintaining the Unit

The unit is a high-tech, precision device. If the optical pick-up lens and disc drive parts are dirty or worn, the picture quality could be diminished.

For details, please contact your nearest authorized service center.

Playable Discs



Blu-ray Disc

- Discs such as movies that can be purchased or rented
- BD-R/RE discs that contain audio titles, MPEG4, MP3, WMA, or Photo files.



DVD-VIDEO

- Discs such as movies that can be purchased or rented



DVD-R

- Video mode and finalized only
- Supports the dual layer disc also
- AVCHD format
- DVD-R discs that contain audio titles, MPEG4, MP3, WMA, or Photo files.



DVD-RW

- VR mode, Video mode and finalized only
- AVCHD format
- DVD-RW discs that contain audio titles, MPEG4, MP3, WMA, or Photo files.

+R

- Finalized disc only
- Supports the dual layer disc also
- AVCHD format
- DVD+R discs that contain audio titles, MPEG4, MP3, WMA, or Photo files.

+RW

- Video mode and finalized only
- AVCHD format
- DVD+RW discs that contain audio titles, MPEG4, MP3, WMA, or Photo files.



Audio CD

- Audio CDs or CD-Rs/CD-RWs in audio CD format that can be purchased



CD-R/CD-RW

- CD-R/CD-RW discs that contain audio titles, MPEG4, MP3, WMA, or Photo files.

AVCHD (Advanced Video Codec High Definition)

- This player can playback AVCHD format discs. These discs are normally recorded and used in camcorders.
- The AVCHD format is a high definition digital video camera format.
- The MPEG-4 AVC/H.264 format is capable of compressing images at higher efficiency than that of the conventional image compressing format.
- Some AVCHD discs use the “x.v.Color” format.
- This player can playback AVCHD discs using “x.v.Color” format.

- Some AVCHD format discs may not play, depending on the recording condition.
- AVCHD format discs need to be finalized.
- “x.v.Color” offers a wider color range than normal DVD camcorder discs.

Regional Code

This unit has a regional code printed on the rear of the unit. This unit can play only BD-ROM or DVD discs labeled same as the rear of the unit or “ALL”.

Notes:

- Depending on the conditions of the recording equipment or the CD-R/RW (or DVD-R/RW, +R/+RW) disc itself, some CD-R/RW (or DVD-R/RW, +R/+RW) discs cannot be played on the unit.
- Do not attach any seal or label to either side (the labeled side or the recorded side) of a disc.
- Do not use irregularly shaped CDs (e.g., heart-shaped or octagonal). Doing so may result in malfunctions.
- Depending on the recording software & the finalization, some recorded discs (CD-R/RW or DVD-R/RW, +R/+RW) may not be playable.
- DVD-R/RW, +R/+RW and CD-R/RW discs recorded using a personal computer or a DVD or CD Recorder may not play if the disc is damaged or dirty, or if there is dirt or condensation on the player’s lens.
- If you record a disc using a personal computer, even if it is recorded in a compatible format, there are cases in which it may not play because of the settings of the application software used to create the disc. (Check with the software publisher for more detailed information.)
- This player requires discs and recordings to meet certain technical standards in order to achieve optimal playback quality. Pre-recorded DVDs are automatically set to these standards. There are many different types of recordable disc formats (including CD-R containing MP3 or WMA files) and these require certain pre-existing conditions to ensure compatible playback.
- Customers should note that permission is required in order to download MP3 / WMA files and music from the Internet. Our company has no right to grant such permission. Permission should always be sought from the copyright owner.
- This player supports 8 cm disc except Blu-ray Disc.

BD-ROM Disc Features

BD-ROM Discs can store 25 GB (single layer) or 50 GB (dual layer) on a single sided disc - about 5 to 10 times the capacity of a DVD.

BD-ROM Discs also support the highest quality HD video available in the industry (up to 1920 x 1080) - Large capacity means no compromise on video quality. Furthermore, a BD-ROM disc has the same familiar size and look as DVD.

- The following BD-ROM disc features are disc dependent and will vary.
- Appearance and navigation of features will also vary from disc to disc.
- Not all discs will have the features described below.
- BD-ROM, Hybrid disc have both BD-ROM and DVD (or CD) layers on one side. On such discs, BD-ROM layer will be only played back in this player.

Video highlights

The BD-ROM format for movie distribution supports three highly advanced video codecs, including MPEG-2, MPEG4 AVC (H.264), and SMPTE VC1. HD video resolutions are also available:

- 1920 x 1080 HD
- 1280 x 720 HD

For High-Definition Playback

To view high-definition contents from BD-ROM discs, an HDTV is required. Some discs may require HDMI OUT for viewing of high-definition contents. Ability to view high-definition contents in BD-ROM discs may be limited depending on the resolution of your TV.

Graphic planes

Two individual, full HD resolution (1920x1080) graphic planes (layers) are available, on top of the HD video layer. One plane is assigned to video-related, frame accurate graphics (like subtitles), and the other plane is assigned to interactive graphic elements, such as buttons or menus.

For both planes, various wipes, fades and scroll effects may be available.



Graphic Plane

HD Video

Menu sounds

When you highlight or select a menu option, sounds can be heard such as button clicks or a voice-over explaining the highlighted menu choice.

Multi-page/PopUp Menus

With DVD-Video, playback is interrupted each time a new menu screen is accessed. Due to BD-ROM disc's ability to preload data from the disc without interrupting playback, a menu can consist of several pages.

You can browse through the menu pages or select different menu paths, while the audio and video remain playing in the background.

Interactivity

Certain BD-ROM Discs may contain animated menus and/or trivia games.

User Browsable Slideshows

With BD-ROM Discs, you can browse through various still pictures while the audio remains playing.

Subtitles

Depending on what is contained on the BD-ROM disc, you may be able to select different font styles, sizes and colors for some subtitles. Subtitles may also be animated, scrolled or faded in and out.

BD-J Interactive Capability

The BD-ROM format supports Java for interactive functions. "BD-J" offers content providers almost unlimited functionality when creating interactive BD-ROM titles.

BD-ROM Disc Compatibility

This player supports BD-ROM Profile 2.

- Discs supporting BD-Live (BD-ROM version 2 Profile 2) that allows interactive functions to be used when this unit is connected to the Internet in addition to the BONUSVIEW function.
- Discs supporting BONUSVIEW (BD-ROM version 2 Profile 1 version 1.1/Final Standard Profile) that allows Virtual packages or Picture-in-Picture functions to be used.
- See "Enjoying BD-LIVE™ or BONUS VIEW™ in BD-Video" on page 28 for details.

Compatibility Notes

- Because BD-ROM are a new format, certain disc, digital connection and other compatibility issues are possible. If you experience compatibility problems, please contact an authorized Customer Service Center.
- Viewing high-definition content and up-converting standard DVD content may require an HDMI-capable input or HDCP-capable DVI input on your display device.
- Some BD-ROM and DVD discs may restrict the use of some operation commands or features.
- Dolby TrueHD, Dolby Digital Plus and DTS-HD are supported with maximum 7.1 channels if you use HDMI connection for the audio output of the unit.
- You can use a USB Flash Drive that is used to store some disc related information, including downloaded on-line content. The disc you are using will control how long this information is retained.

Certain System Requirements

For high definition video playback:

- High definition display that has COMPONENT or HDMI input jacks.
- BD-ROM disc with high definition content.
- HDMI or HDCP capable DVI input on your display device is required for some content (as specified by disc authors).
- For up-conversion of standard definition DVD, an HDMI or HDCP capable DVI input on your display device is required for copy protected content.

For Dolby® Digital Plus, Dolby TrueHD and DTS-HD multi-channel audio playback:

- An amplifier/receiver with a built-in (Dolby Digital, Dolby Digital Plus, Dolby TrueHD, DTS or DTS-HD) decoder.
- Main, center, surround speakers and subwoofer as necessary for chosen format.

Resetting the Player

If you observe any of the following symptoms...

- When the Player is plugged in, but the power will not turn on or off.
- When the display window is not working.
- When the Player does not operate normally.

You can reset the Player as follows:

- Press and hold the STANDBY/ON button for more than five seconds. This will force the Player to power off. Press the STANDBY/ON button again to turn the Player back on.
- Unplug the power cord and then plug the power cord again after more than five seconds.

Using a USB Flash Drive

This unit can play the movie, music and photo files contained on the USB Flash Drive.

Insert/Remove a USB Flash Drive

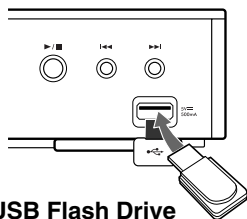

USB Flash Drive

Inserting a USB Flash Drive

Insert straight-in until it fits into place.

Removing a USB Flash Drive

Withdraw the USB Flash Drive carefully.

Notes:

- This unit supports only USB Flash Drive with FAT16 or FAT32 format.
- The USB Flash Drive can be used for the local storage for enjoying BD-Live discs with Internet
- Do not extract the USB Flash Drive during operation (play, etc.).
- A USB Flash Drive which requires additional program installation when you have connected it to a computer is not supported.
- USB Flash Drive: USB Flash Drive that support USB1.1 and USB2.0.
- Movie Files (MPEG4), Music files (MP3/WMA) and photo files (JPEG/PNG/GIF) can be played. For details of operations on each file, refer to relevant pages.
- Regular back up is recommended to prevent data loss.
- If you use a Card Reader, USB extension cable or USB HUB, the USB Flash Drive may not be recognized.
- Some USB Flash Drives may not work with this unit.
- Digital camera and mobile phone are not supported.
- USB Port of the unit cannot be connected to PC. The unit cannot be used as a storage device.
- When take off an active device connecting to USB port, please take it off after switching off the unit.
- When connecting with a USB cable, use the USB 2.0 cable those length is less than 1 m.

Using the USB Flash Drive

1. Connect a USB Flash Drive.
2. Press HOME on the Remote Control.
3. Select [Music], [Photo] or [Movie] option then press ENTER.

4. Select [USB] then press ENTER.
[MOVIE], [MUSIC] or [PHOTO] menu appears.
Details for the menu are on pages 30-32.

Using the Home Menu

From the Home Menu screen you can access all the Media for playback and setting of the unit.

1. Press HOME and the [Home Menu] appears.

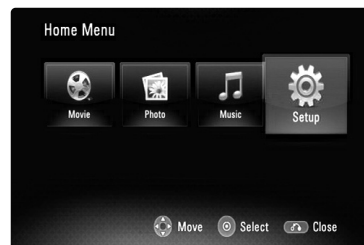

2. Use ◀ / ▶ to select the desired option then press ENTER.

[Movie] – Start video media's playback or displays the [MOVIE] menu.

[Photo] – Displays [PHOTO] menu. (page 32)

[Music] – Displays [MUSIC] menu. (page 31)

[Setup] – Displays [Setup] menu. (page 19)

Note:

When a disc and USB Flash Drive have the contents, it can choose those menus.

About Setup menu:

Menus	Buttons	Operations
Move		Moves the cursor.
Select		Activates the selected item.
Close		Closes the menu.

Tip:

If you select the [Movie], [Photo] or [Music] option when a USB Flash Drive is connected and a disc is inserted simultaneously, the menu for selecting a media will appear. Select a media then press ENTER.

For example:

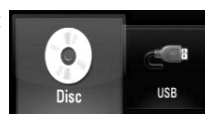

Note:

The unit will be in stop mode then the [Home Menu] will appear if you press HOME during playback.

Front Panel

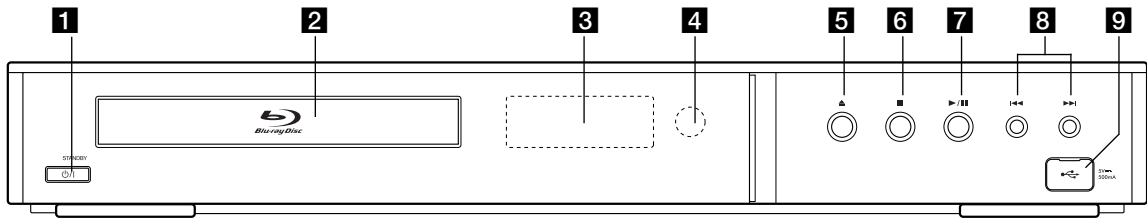

- 1** **⏻/⏻ (STANDBY/ON) Button**
Switches the unit ON or OFF.
- 2** **Disc Tray**
Insert a disc here.
- 3** **Display Window**
Shows the current status of the player.
- 4** **Remote Sensor**
Point the Remote Control here.
- 5** **▲ (OPEN/CLOSE)**
Opens or closes the disc tray.
- 6** **■ (STOP)**
Stops playback.
- 7** **▶ / ⏸ (PLAY / PAUSE)**
Starts playback.
Pause playback temporarily, press again to exit pause mode.
- 8** **⏮ / ⏭ (SKIP)**
Go to next or previous file/track/chapter.
- 9** **USB Port**
Connect a USB Flash Drive.

Rear Panel

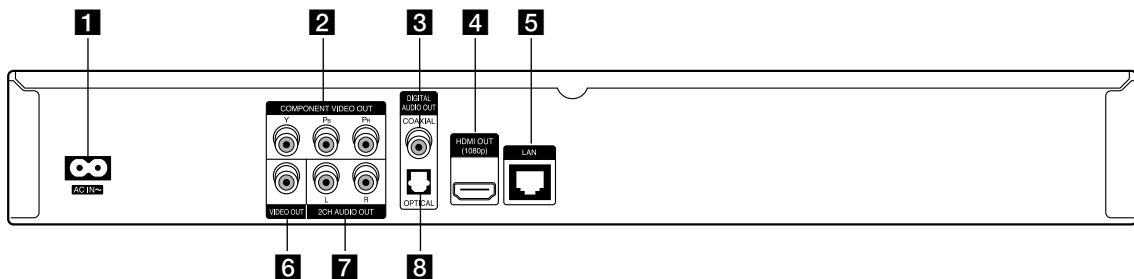

- 1** **AC IN connector**
Connect the supplied power cord.
- 2** **COMPONENT VIDEO OUT (Y Pb Pr)**
Connect to a TV with Y Pb Pr inputs.
- 3** **DIGITAL AUDIO OUT (COAXIAL)**
Connect to digital (coaxial) audio equipment.
- 4** **HDMI OUT (Type A)**
Connect to TV with HDMI inputs. (Interface for digital audio and video)
- 5** **LAN port**
Connect a network with an always-on broadband connection.
- 6** **VIDEO OUT**
Connect to a TV with video inputs.
- 7** **2CH AUDIO OUT (Left/Right)**
Connect to a TV with 2 channel audio inputs.
- 8** **DIGITAL AUDIO OUT (OPTICAL)**
Connect to digital (optical) audio equipment.

Remote Control

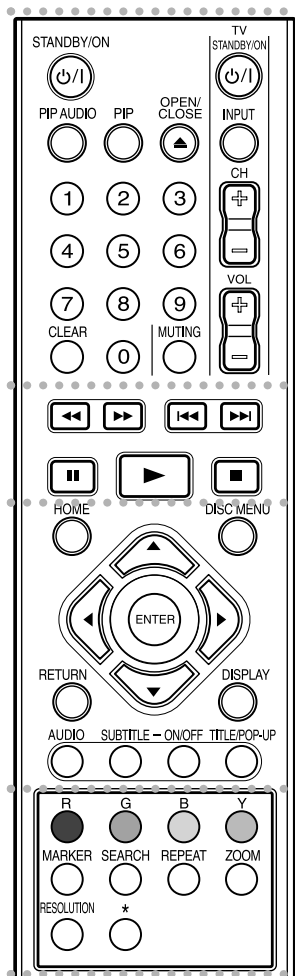

• • • • • **1** • • • • •

STANDBY/ON (⏻/⏻): Switches the player ON or OFF.

PIP AUDIO*: Switch on/off Secondary Audio (BD-ROM only).

PIP*: Switches on/off Secondary Video (Picture-in-picture) (BD-ROM only).

^ Depending on a disc type or the pre-recorded contents of the BD-ROM disc, different functions may be executed than other media or there are no responses when pressing some buttons (depending on media used).

1 OPEN/CLOSE (⏮): Opens and closes the disc tray.

0-9 numerical buttons: Select numbered options in a menu.

CLEAR: Removes a mark on the search menu or a number when setting the password.

2 JVC TV Control Buttons:

- TV STANDBY/ON (⏻/⏻): Turn the TV on or off.
- INPUT: Switch the TV's input source between the TV and other input sources.
- CH (+/-): Scan up or down through memorized channels.
- VOL (+/-): Adjust the volume of the TV.
- MUTING: Temporarily turns TV sound OFF, press again to restore.

3

• • • • • **2** • • • • •

◀ / ▶ (SCAN): Search backward or forward.

⏮ / ⏭ (SKIP): Go to next or previous chapter / track / file.

⏸ (PAUSE/STEP): Pauses playback.

▶ (PLAY): Starts playback.

■ (STOP): Stops playback.

4

• • • • • **3** • • • • •

HOME: Displays or exits the [Home Menu].

DISC MENU: Accesses menu on a disc.

Direction buttons: Select an option in the menu.

ENTER (⊙): Acknowledges menu selection.

RETURN (↶): Exits or closes the menu, or resumes playback. The resume play function may work depending on the BD-ROM disc.

DISPLAY: Displays or exits On-Screen Display.

AUDIO: Selects an audio language or audio channel.

SUBTITLE: Selects a subtitle language.

SUBTITLE ON/OFF: Switches the subtitle on or off.

TITLE/POP-UP: Displays the DVD title menu or BD-ROM's pop-up menu, if available.

• • • • • **4** • • • • •

Color (R, G, B, Y) buttons: Use to navigate BD-ROM menus. They are also used for [MOVIE], [PHOTO] and [MUSIC] menu.

MARKER: Marks any point during playback.

SEARCH: Displays or exits the search menu.

REPEAT: Repeat a desired section.

ZOOM: Displays or exits the [Zoom] menu.

RESOLUTION: Sets the output resolution for HDMI and COMPONENT VIDEO OUT jacks.

* : This button is not available.

Remote Control Operation

Point the Remote Control at the remote sensor and press the buttons.

Caution

- Do not mix old and new batteries and never mix different types of batteries such as standard, alkaline, etc.
- Do not put the batteries in the place where young children can reach.

Remote Control Battery Installation

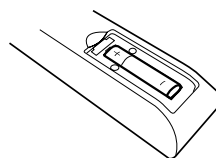

Remove the battery cover on the rear of the Remote Control, and insert a R03 (size AAA) battery with + and - matched correctly.

Installation and Setup

HDMI connection

If you have a HDMI TV or monitor, you can connect it to this player using a HDMI cable.

1. Connect the HDMI jack on the player to the HDMI jack on a HDMI compatible TV or monitor (**H**).
2. Set the TV's source to HDMI (refer to TV's Owner's manual).

Notes:

- You must select a HDMI audio output and a maximum sampling frequency that your TV accepts using [HDMI] and [Sampling Freq.] options on the setup menu (see page 20).
- If a connected HDMI device does not accept the audio output of the unit, the HDMI device's audio sound may be distorted or may not output.

Tips:

- When you use HDMI connection, you can change the resolution for the HDMI output. (Refer to "Resolution Setting" on page 17.)
- Select the type of video output from the HDMI OUT jack using [HDMI Color Setting] option on the [Setup] menu (see page 19).

Cautions

- Changing the resolution when the connection has already been established may result in malfunctions. To solve the problem, turn off the player and then turn it on again.
- When the HDMI connection with HDCP is not verified, TV screen is changed to black screen. In this case, check the the HDMI connection, or disconnect the HDMI cable.
- If there is noise or lines on the screen, please check the HDMI cable (length is generally limited to 15ft).

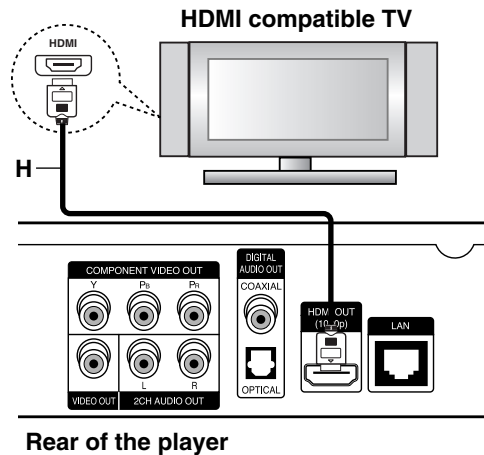

Additional Information for HDMI

- When you connect a HDMI or DVI compatible device make sure of the following:
 - Try switching off the HDMI/DVI device and this player. Next, switch on the HDMI/DVI device and leave it for around 30 seconds, then switch on this player.
 - The connected device's video input is set correctly for this unit.
 - The connected device is compatible with 720x480p, 1280x720p, 1920x1080i or 1920x1080p video input.
- Not all HDCP-compatible HDMI or DVI devices will work with this player.
 - The picture will not be displayed properly with non-HDCP device.
 - This player does not playback and TV screen is changed to black screen.

Connections to Your TV

Make one of the following connections, depending on the capabilities of your existing equipment.

Tips:

- Depending on your TV and other equipment you wish to connect, there are various ways you could connect the player. Use only one of the connections described below.
- Please refer to the manuals of your TV, Stereo System or other devices as necessary to make the best connections.

Caution

- Make sure the player is connected directly to the TV. Tune the TV to the correct video input channel.
- Do not connect the player's AUDIO OUT jack to the phono in jack (record player) of your audio system.
- Do not connect your player via your VCR. The image could be distorted by the copy protection system.

Component Video Connection

Connect the COMPONENT VIDEO OUT jacks on the player to the corresponding input jacks on the TV using Y Pb Pr cables (**C**).

Tip:

When you use COMPONENT VIDEO OUT connection, you can change the resolution for the output. (Refer to "Resolution setting" on page 17.)

Video Connection

Connect the VIDEO OUT jack on the player to the video in jack on the TV using a video cable (**V**).

Audio (Left/Right) Connection

Connect the left and right AUDIO OUT jacks of the player to the audio left and right IN jacks on the TV using the audio cables (**A**).

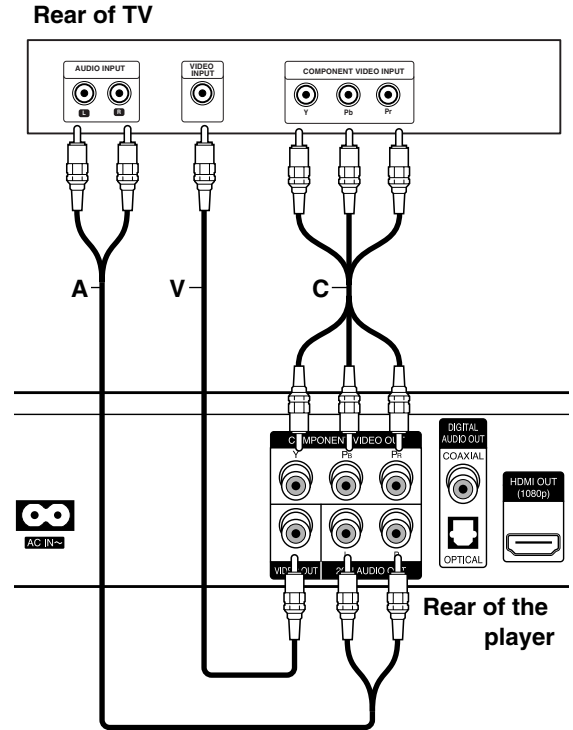

Connecting to an Amplifier

Make one of the following connections, depending on the capabilities of your existing equipment.

Note:

Since many factors affect the type of audio output, see “The unit’s Audio Output Specifications” on page 36 for details.

Connecting to an Amplifier via 2 Channel Audio Output

Connect the Left and Right 2CH AUDIO OUT jacks on the player to the audio left and right in jacks on your amplifier, receiver, or stereo system, using audio cables **(A)**.

Connecting to an Amplifier via Digital Audio Output (Optical or Coaxial)

1. Connect the player’s DIGITAL AUDIO OUT jack to the corresponding in jack (OPTICAL **O** or COAXIAL **X**) on your amplifier. Use an optional digital (optical **O** or coaxial **X**) audio cable.
2. You will need to activate the player’s digital output. (See “[AUDIO] Menu” on pages 20.)

Connecting to an Amplifier via HDMI Output

1. Connect the player’s HDMI OUT jack to the corresponding in jack on your amplifier. Use an HDMI cable **(H1)**.
2. You will need to activate the player’s digital output. (See “[AUDIO] Menu” on pages 20.)

Tip:

Connect the amplifier’s HDMI output jack to HDMI input jack on your TV using an HDMI cable **(H2)** if your amplifier has HDMI output jack.

Digital Multi-channel sound

A digital multi-channel connection provides the best sound quality. For this you need a multi-channel Audio/Video Receiver that supports one or more of the audio formats supported by your player. Check the receiver manual and the logos on the front of the receiver. (PCM Stereo, PCM Multi-Ch, Dolby Digital, Dolby Digital Plus, Dolby TrueHD, DTS and/or DTS-HD)

Notes:

- You must select a digital audio output and a maximum sampling frequency that your Amplifier (or AV receiver) accepts using [SPDIF], [HDMI] and [Sampling Freq.] options on the [Setup] menu (see page 20).
- With digital audio connection (SPDIF or HDMI), Disc Menu button sounds of BD-ROM may not be heard if the [SPDIF] or [HDMI] option is set to [Primary Pass-Thru].
- If the audio format of the digital output does not match the capabilities of your receiver, the receiver will produce a strong, distorted sound or no sound at all.
- Multi-channel Digital Surround Sound via digital connection can only be obtained if your receiver is equipped with a Digital Multi-channel decoder.
- To see the audio format of the current disc in the on-screen display, press AUDIO.

Rear of the player

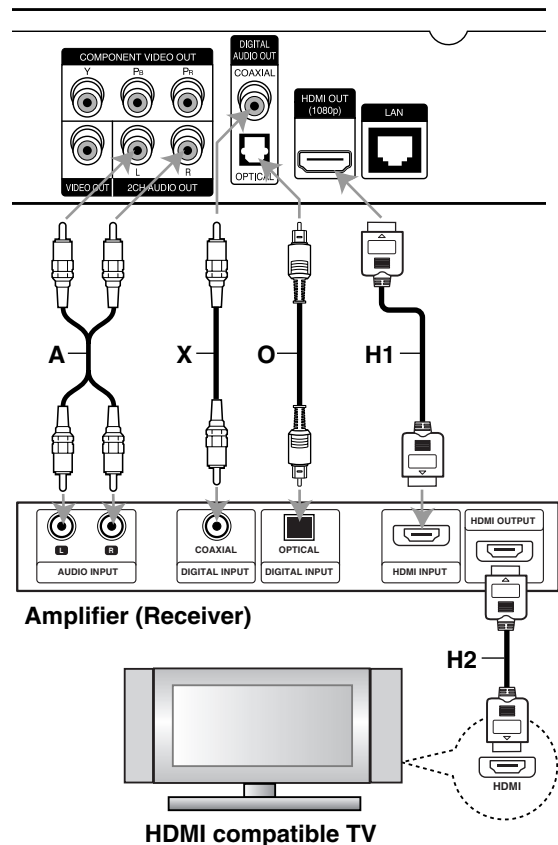

Internet connection

This player can be connected to a local area network (LAN) via the LAN port on the rear panel. After making the physical connection the player needs to be set up for network communication. This is done from the [Setup] menu — see “[NETWORK] Menu” on page 22 for detailed instructions.

Connect the player’s LAN port to the corresponding port on your Modem or Router using a LAN cable. Use a commercially available straight LAN cable (Category 5/CAT5 or better with RJ45 connector).

By connecting the unit to broadband Internet, you can use a disc that offers BD-Live function (see page 28).

Cautions:

- When plugging or unplugging the LAN cable, hold the plug portion of the cable. When unplugging, do not pull on the LAN cable but unplug while pressing down on the lock.
- Do not connect a modular phone cable to the LAN port.
- Since there are various connection configurations, please follow the specifications of your telecommunication carrier or internet service provider.

Rear of the player

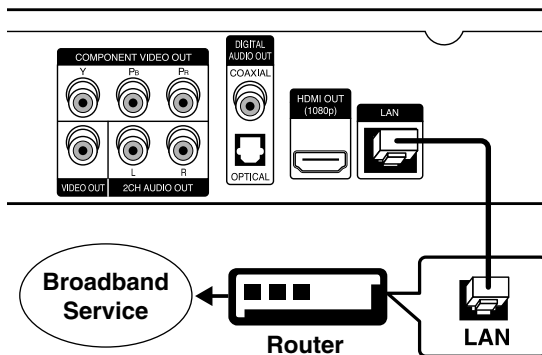

Notes:

- Depending on the internet service provider (ISP), the number of devices that can receive internet service may be limited by the applicable terms of service. For details, contact your ISP.
- Our company is not responsible for any malfunction of the player and/or the internet connection feature due to communication errors/malfunctions associated with your broadband internet connection, or other connected equipment.
- Our company is not responsible for any trouble in your internet connection.

- The features of BD-ROM discs made available through the Internet Connection feature are not created or provided by our company, and our company is not responsible for their functionality or continued availability. Some disc related material available by the Internet Connection may not be compatible with this player. If you have questions about such content, please contact the producer of the disc.
- Some internet contents may require a higher bandwidth connection.
- Even if the player is properly connected and configured, some internet contents may not operate properly because of internet congestion, the quality or bandwidth of your internet service, or problems at the provider of the content.
- Some internet connection operations may not be possible due to certain restrictions set by the Internet service provider (ISP) supplying your broadband Internet connection.
- Any fees charged by an ISP including, without limitation, connection charges are your responsibility.
- A 10 Base-T or 100 Base-TX LAN port is required for connection to this player. If your internet service does not allow for such a connection, you will not be able to connect the player.
- You must use a Router to use xDSL service.
- A DSL modem is required to use DSL service and a cable modem is required to use cable modem service. Depending on the access method of and subscriber agreement with your ISP, you may not be able to use the internet connection feature contained in this player or you may be limited to the number of devices you can connect at the same time. (If your ISP limits subscription to one device, this player may not be allowed to connect when a PC is already connected.)
- The use of a “Router” may not be allowed or its usage may be limited depending on the policies and restrictions of your ISP. For details, contact your ISP directly.
- Your ISP may protect this player from being connected to network when confirming MAC ADDRESS. In that case, contact your ISP to request to initialize MAC ADDRESS.

Resolution Setting

The player provides several output resolutions for HDMI OUT and COMPONENT VIDEO OUT jacks. You can change the resolution using [Setup] menu or pressing the RESOLUTION button in stop mode.

Note:

Since several factors affect the resolution of video output, see “Video output according to the Resolution setting” on next page.

Auto – If the HDMI OUT jack is connected for TVs providing display information (EDID), automatically selects the resolution best suited to the connected TV. If the COMPONENT VIDEO OUT is only connected, this changes the resolution to 1080i as default resolution.

1080p – Outputs 1080 lines of progressive video.

1080i – Outputs 1080 lines of interlaced video.

720p – Outputs 720 lines of progressive video.

480p – Outputs 480 lines progressive video.

480i – Outputs 480 lines of interlaced video.

How to change the resolution using RESOLUTION button

Press RESOLUTION button in stop mode.



How to change the resolution using Setup menu

1. Press HOME and the Home Menu appears.
2. Select [Setup] and press ENTER. The Setup menu appears.
3. Use ▲ / ▼ to select [DISPLAY] option then press ► to move to the second level.
4. Use ▲ / ▼ to select the [Resolution] option then press ► to move to the third level.

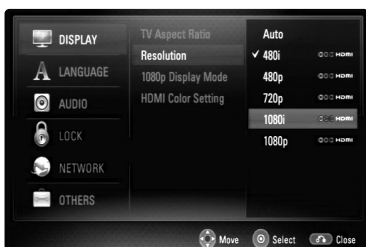

5. Use ▲ / ▼ to select the desired resolution then press ENTER to confirm your selection.

Available resolution according to connection and media format

HDMI OUT connection

- If you select a resolution manually and then connect the HDMI jack to TV and your TV does not accept it, the resolution setting is set to [Auto].
- If the [1080p Display Mode] option is set to [24 Hz], the 1080p video output frame rate may be automatically set to either 24Hz or 60Hz depending both on the capability and preference of the connected TV and based on the native video frame rate of the content on the BD-ROM disc.

COMPONENT VIDEO OUT connection

- For the 720p, 1080i, 1080p resolution setting with protected media, real output resolution of COMPONENT VIDEO OUT will be outputted at 480p resolution.
- Even if the resolution is set to 1080p, non-copy protected BDs and DVDs playback are outputted at 1080i resolution.
- BD or DVD video stream could prevent up-scaling on analog output.

VIDEO OUT connection

- The resolution of the VIDEO OUT jack is always outputted at 480i resolution.

Notes:

- Depending on your display, some of the resolution settings may result in the picture disappearing or an abnormal picture appearing. In this case, press HOME key then RESOLUTION repeatedly until the picture re-appear.
- This player supports simultaneous output of all video out jacks. The resolution of the HDMI output may not be the same as the resolution output on the component video output.
- When the 1080p/24Hz video source is outputted via HDMI connection, the VIDEO OUT and COMPONENT VIDEO OUT will not output any video signal.

Available resolution according to the resolution setting

• When the non-copy protected media is playing back

Resolution Setting \ Video Output	HDMI OUT	COMPONENT VIDEO OUT
480i	480i	480i
480p	480p	480p
720p	720p	720p
1080i	1080i	1080i
1080p / 24Hz	1080p / 24Hz	1080i / 60Hz *
1080p / 60Hz	1080p / 60Hz	1080i / 60Hz

• When the copy protected media is playing back

Resolution Setting \ Video Output	HDMI OUT	COMPONENT VIDEO OUT
480i	480i	480i
480p	480p	480p
720p	720p	480p
1080i	1080i	480p
1080p / 24Hz	1080p / 24Hz	480p*
1080p / 60Hz	1080p / 60Hz	480p

* When the 1080p/24Hz video source is outputted via HDMI connection, the VIDEO OUT and COMPONENT VIDEO OUT will not output any video signal.

Initial Settings

By using the Setup menu, you can make various adjustments to items such as picture and sound. You can also set a language for the subtitles and the Setup menu, among other things. For details on each Setup menu item, see pages 19 to 23.

To display and exit the Menu:

Press HOME and the Home Menu appears. Select [Setup] then press ENTER, and Setup menu appears.

Press RETURN or HOME to exit the Setup menu.

To go to the next level:

Press ► on the Remote Control.

To go back to the previous level:

Press ◀ on the Remote Control.

General Operation

1. Press HOME and the Home Menu appears.
2. Select [Setup] and press ENTER. The Setup menu appears.



3. Use ▲ / ▼ to select the desired option then press ► to move to the second level. The screen shows the current setting for the selected item, as well as alternate setting(s).
4. Use ▲ / ▼ to select the second desired option then press ► to move to the third level.
5. Use ▲ / ▼ to select the desired setting then press ENTER to confirm your selection. Some items require additional steps.
6. Press RETURN or HOME to exit the Setup menu.

[DISPLAY] Menu



TV Aspect Ratio

[4:3 Letter Box] – Select when a standard 4:3 TV is connected. Displays theatrical images with masking bars above and below the picture.

[4:3 Pan Scan] – Select when a standard 4:3 TV is connected. Displays pictures cropped to fill your TV screen. Both sides of the picture are cut off.

[16:9 Original] – Select when a 16:9 wide TV is connected. The 4:3 picture is displayed with an original 4:3 aspect ratio, with black bars appearing at the left and right sides.

[16:9 Wide] – Select when a 16:9 wide TV is connected. The 4:3 picture is adjusted horizontally (in a linear proportion) to fill the entire screen.

Resolution

Sets the output resolution of the Component and HDMI video signal. Refer to “Resolution Setting” on page 17 for details about the resolution.

1080p Display Mode

When the resolution is set to 1080p, select [24Hz] for smooth presentation of film material (1080p/24Hz) with an HDMI-equipped display compatible with 1080p/24Hz input.

Notes:

- When you select [24Hz], you may experience some picture disturbance when the video switches video and film material. In this case, select [60Hz].
- Even when [1080p Display Mode] is set to [24Hz], if your TV is not compatible with 1080p/24Hz, the actual frame frequency of the video output will be 60 Hz.
- When the 1080p/24Hz video source is outputted via HDMI connection, the VIDEO OUT and COMPONENT VIDEO OUT will not output any video signal.
- If you want to set the 1080p/24Hz, set the resolution setting to [1080p] and [1080p Display Mode] option to [24Hz].

HDMI Color Setting

Select the type of output from the HDMI OUT jack. For this setting, please refer to the manuals of your display device.

[YCbCr] – Select when connecting to an HDMI display device.

[RGB] – Select when connecting to an RGB display device.

Note:

When you connect the HDMI OUT jack to DVI display device, the [HDMI Color Setting] will automatically switch to [RGB].

[LANGUAGE] Menu



Display Menu

Select a language for the [Setup] menu and on-screen display.

Disc Menu / Disc Audio / Disc Subtitle

Select the language you prefer for the audio track (disc audio), subtitles, and the disc menu.

[Original] – Refers to the original language in which the disc was recorded.

[Other] – Press ENTER to select another language. Use number buttons then ENTER to enter the corresponding 4-digit number according to the language code list on page 33.

[Off] (for Disc Subtitle) – Turn off Subtitle.

Note:

Depending upon the disc, your language setting may not work for some discs.

[AUDIO] Menu

Each disc has a variety of audio output options. Set the player's Audio options according to the type of audio system you use.

Note:

Since many factors affect the type of audio output, see "The unit's Audio Output Specifications" on page 36 for details.

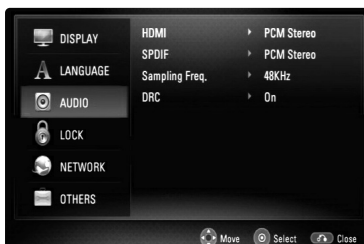

HDMI / SPDIF (Digital Audio Output)

Select the output sound format when a device equipped with an HDMI or Digital Audio input jack is connected to the HDMI OUT or DIGITAL AUDIO OUT jack on this player.

[PCM Stereo] – Select if you connect this unit's HDMI OUT or DIGITAL AUDIO OUT jack to a device with two-channel digital stereo decoder.

[PCM Multi-Ch] (HDMI only) – Select if you connect this unit's HDMI OUT jack to a device with multi-channel digital decoder.

[DTS Re-Encode] – Select if you connect this unit's HDMI OUT or DIGITAL AUDIO OUT jack to a device with DTS decoder.

[Primary Pass-Thru] – Select if you connect this unit's DIGITAL AUDIO OUT and HDMI OUT jack to a device with LPCM, Dolby Digital, Dolby Digital Plus, Dolby TrueHD, DTS and DTS-HD decoder.

Notes:

- When [HDMI] option is set to [PCM Multi-CH], the audio may output as PCM Stereo if the PCM Multi-Ch information is not detected from HDMI device with EDID.
- If the connected device is only capable of PCM, the menu can be changed but it will not affect the actual output format.

Sampling Freq. (Only for SPDIF audio)

[192KHz] – Select this if your A/V Receiver or Amplifier is capable of handling 192 KHz signals.

[96KHz] – Select this if your A/V Receiver or Amplifier is NOT capable of handling 192 KHz signals. When this choice is made, this unit automatically converts any 192 KHz signals to 96 KHz so your system can decode them.

[48KHz] – Select this if your A/V Receiver or Amplifier is NOT capable of handling 192 KHz and 96 KHz signal. When this choice is made, this unit automatically converts any 192 KHz and 96 KHz signals to 48 KHz so your system can decode them.

Check the documentation for your A/V Receiver or Amplifier to verify its capabilities.

DRC (Dynamic Range Control)

When a disc encoded in Dolby Digital or Dolby Digital Plus is playing back, you may wish to compress the dynamic range of the audio output (the difference between the loudest sounds and the quietest ones). This allows you to listen to a movie at a lower volume without losing clarity of sound. Set DRC to [On] for this effect.

[LOCK] Menu (Parental Control)

Use the ▲ / ▼ / ◀ / ▶ buttons to select [LOCK] settings in the [Setup] menu.

The [LOCK] settings affect only BD and DVD playback. Set the password and have to input it to validate the [LOCK] settings.



Password

You can create, change or delete the password.

1. Select [Password] option on the [LOCK] menu then press ▶.
2. Use number buttons on the remote control to input the 4-digit password.

To create new password, press ENTER when the [New] option is highlighted. Input new password and press ENTER. Enter it again and press ENTER to verify.

To change the password, press ENTER when the [Change] option is highlighted, then input old password and press ENTER. Input new password and press ENTER. Enter it again and press ENTER to verify.

To delete the password, select [Delete] option then press ENTER, then input old password and press ENTER. The password is deleted.

Tip:

If you make a mistake before pressing ENTER, press ◀ to delete a number one by one.

If you forget your password

If you forget your password, you can clear it using the following steps:

1. Remove any disc that might be in the player.
2. Select [LOCK] → [Password] option in the [Setup] menu.
3. Use Number buttons to enter the 6-digit number "210499".
The password is cleared.

Rating **DVD**

Blocks playback of rated disc based on their content. (Not all discs are rated.)

1. Select [Rating] on the [LOCK] menu then press ▶.
2. To access this option, you must input the password you have created. If you have not yet entered password, you will be prompted to do so. Input a password and press ENTER. Enter it again and press ENTER to verify. If you make a mistake before pressing ENTER, press ◀ to delete a number one by one.
3. Select a rating from 1 to 8 using the ▲ / ▼ buttons.

[Rating 1-8] – Rating one (1) has the most restrictions and rating eight (8) is the least restrictive.

[Unlock] – If you select unlock, parental control is not active and the disc plays in full.

4. Press ENTER to confirm your rating selection.

BD Age **BD**

Set an age limit for BD-ROM viewing.

1. Select [BD Age] on the [LOCK] menu then press ▶.
2. Follow step 2 as shown above (Rating).
3. Use number buttons to input an age limit for BD-ROM viewing.

[255] – All BD-ROM can be played.

[0-254] – Prohibits play of BD-ROM with corresponding ratings recorded on them.

4. Press ENTER to confirm your selection.

Area Code

Enter the code of the area whose standards were used to rate the DVD video disc, based on the list on page 33.

1. Select [Area Code] on the [LOCK] menu then press ▶.
2. Follow step 2 as shown above (Rating).
3. Select the first character using ▲ / ▼ buttons then press ENTER.
4. Select the second character using ▲ / ▼ buttons then press ENTER to confirm your selection.

[NETWORK] Menu

The [NETWORK] settings are needed to use the BD-Live features.

Some BD-ROM discs may enable you to access special BD-ROM sites, if you connect the player to the Internet. For example, if an BD-ROM site includes content such as links to future movie trailers, you can watch the downloaded on-line content on the player.

You do not need to connect to a PC to use this function.

Preparations:

- This feature requires an always-on broadband internet connection. (see page 16.)
- An BD-ROM disc compatible with this feature is required. Not all BD-ROM discs are compatible.



IP Mode

If there is a DHCP server on the local area network (LAN), this player will automatically be allocated an IP address. If you're using a broadband router or broadband modem that has a DHCP (Dynamic Host Configuration Protocol) server function, select [Dynamic IP]. The IP address will automatically be determined.

If there is no DHCP server on the network and you want to set the IP address manually, select [Static IP] then set the [IP Address], [Subnet Mask], [Gateway] and [DNS Server] using [IP Setting] option.

How to check the network configuration

Select [IP Mode] option and check the Network status indicator shown above the menu. (The Network status indicator changes according to Network configuration.)



Able to use network



Testing Network



Unable to use network

IP Setting

This option is available only if [IP Mode] option is set to [Static IP].

Use the ▲ / ▼ / ◀ / ▶ buttons to select a field; use the number buttons to enter a value. Press ENTER when [OK] is highlighted to finish and exit the screen.

BD-LIVE connection

You can restrict Internet access when BD-Live functions are used. See "Enjoying BD-LIVE™ or BONUS VIEW™ in BD-Video" on page 28 for details.

[Permitted] – Internet access is permitted for all BD-Live contents.

[Partially permitted] – Internet access is permitted only for BD-Live contents which have content owner certificates. Internet access and AACs Online functions are prohibited for all BD-Live contents without a certificate.

[Prohibited] – Internet access is prohibited for all BD-Live contents.

When [Prohibited] is selected, the screen may become black when BD-Live functions are selected. Press STOP to return to Main menu.

Notes:

- Connection confirmation of the Internet is displayed when BD-Live mode is started.
- There are BD-Live data downloaded in USB Flash Drive.

[OTHERS] Menu

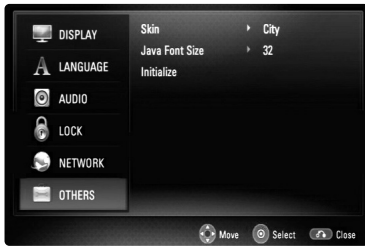

Skin

Changes the background of the initial screen.

Java Font Size **BD**

You can adjust the default text size displayed for the BD-J contents during BD-ROM playback.

This setting is only valid when BD-J contents do not set the size of text.

Please select a font size bigger than 24 when the player is connected with an HD TV.

Initialize

You can reset the player to its original factory settings or initialize the BD storage.

1. Select [Initialize] option then press ►.
2. Press ▲ / ▼ to select the desired option then press ENTER.
The confirm message will appear.

[Factory Set] – If you need to, you can reset the player to all its factory settings. Some options cannot be reset. (Rating, Password and Area Code, etc.)

[BD Storage Clear] – Deletes the downloaded on-line content for BD-Live feature from the connected USB Flash Drive. The files (such as movie, music or photo file) stored in the USB Flash Drive except content downloaded via BD-Live are not erased.

3. Use ◀ / ▶ to select [Yes] or [No] then press ENTER.

Operations

General playback features

1. Load your chosen disc in the tray, with the playback side down.
2. Start playback using the HOME menu (see page 10).

Buttons	Operations	Discs
OPEN / CLOSE (▲)	Opens or closes the disc tray.	ALL
▶ (PLAY)	Starts the playback.	ALL
ENTER	Acknowledges the selection on the menu screen (Disc menu, Title menu, POP-UP menu, etc.).	BD DVD
■ (STOP)	Stops the playback. The unit records the stopped point, depending on the disc. "■■■" appears on the screen briefly. Press ▶ (PLAY) to resume playback (from the scene point). If you press ■ (STOP) again or unload the disc ("■" appears on the screen.), the unit will clear the stopped point. (■■■ = Resume Stop, ■ = Complete Stop) Notes: <ul style="list-style-type: none"> • The resume point may be cleared when a button is pressed (for example; STANDBY/ON, OPEN/CLOSE, etc). • On BD-Video discs including BD-J, the resume play function does not work. • On BD-ROM interactive title, the unit will be in Complete Stop mode if you press ■ (STOP) once during playback. 	ALL BD DVD ACD MP3 WMA AVCHD MPEG4
⏸ (PAUSE)	During playback, press ⏸ (PAUSE) to pause playback. Tip: During Audio CD or MP3/WMA playback, press ⏸ (PAUSE) once again to resume playback. Press ⏸ (PAUSE) repeatedly to play Frame-by-Frame.	ALL DVD BD AVCHD MPEG4
⏮ / ⏭ (SKIP)	During playback, press ⏮ or ⏭ to go to the next chapter/track/file or to return to the beginning of the current chapter/track/file. Press ⏮ twice briefly to step back to the previous chapter/track/file.	ALL
⏪ / ⏩ (SCAN)	During playback, press SCAN (⏪ or ⏩) repeatedly to select the required scan speed. - DVD, BD, AVCHD, MPEG4: 5 steps, - Audio CD, MP3, WMA: 3 steps While the playback is paused, press SCAN ⏩ repeatedly to play in slow motion (4 steps, forward only).	ALL DVD BD AVCHD MPEG4
TITLE/POP-UP	If the current DVD or BD-ROM disc has a menu, the Title menu or Popup menu appears on the screen. Depending on the disc, the menu may not be available.	DVD BD AVCHD
DISC MENU	The menu appears on the screen. Depending on the disc, the menu may not be available.	DVD BD AVCHD

Continued →

General playback features (Continued)

Buttons	Operations	Discs
REPEAT	<p>Playing repeatedly: During playback, press REPEAT repeatedly to select a desired repeat mode. DVD, BD, AVCHD: Chapter/Title/Off Audio CD, MP3, WMA, MPEG4: Track/All/Off</p> <p>Note: If you press ►► once during Repeat Chapter/Track playback, the repeat playback cancels.</p> <p>Repeating a specific portion (A-B): During playback, press REPEAT to select [A-] at the beginning of the portion you wish to repeat and press ENTER at the end of the portion. To return to normal playback, press REPEAT repeatedly to select [Off].</p> <p>Note: You cannot select a portion less than 3 seconds.</p>	<p>DVD BD ACD MP3 WMA AVCHD MPEG4</p>
SUBTITLE	<p>During playback, press SUBTITLE repeatedly to select a desired subtitle language.</p> <p>Note: Some discs allow you to change subtitle selections only via the disc menu. If this is the case, press TITLE/POPUP or DISC MENU button and choose the appropriate subtitle from the selections on the disc menu.</p>	<p>DVD BD AVCHD MPEG4</p>
SUBTITLE ON/OFF	<p>During playback, press SUBTITLE ON/OFF to switch the subtitle on or off.</p>	<p>DVD BD AVCHD MPEG4</p>
AUDIO	<p>During playback, press AUDIO repeatedly to hear a different audio language or audio track.</p> <p>Notes:</p> <ul style="list-style-type: none"> Some discs allow you to change audio selections only via the disc menu. If this is the case, press TITLE/POPUP or DISC MENU button and choose the appropriate audio from the selections on the disc menu. Immediately after you have switched sound, there may be a temporary discrepancy between the display and actual sound. On BD-ROM disc, the multi audio format (5.1CH or 7.1CH) is displayed with [MultiCH] in the on-screen display. 	<p>DVD BD AVCHD MPEG4</p>

Notes on general features:

- When you turn on the player or replace a disc, the player returns to the initial default setting. Depending on a disc, a specific type of audio the disc has is output.
- Depending on the pre-recorded contents of the BD-ROM, some functions may not be available or may be operated differently than other media.

If a disc menu screen is displayed

DVD **BD** **AVCHD** **MPEG4**

The menu screen may be displayed first after loading a disc which contains a menu.

Use ◀ / ▶ / ▲ / ▼ buttons to select the title/chapter you want to view, then press ENTER to start playback.

Enlarge the playback image

DVD **AVCHD** **MPEG4**

1. During playback or pause mode, press ZOOM to display the [Zoom] menu.
2. Use ◀ / ▶ to select zoom mode (16 steps). Press RETURN to exit the [Zoom] menu.
3. To return to the normal picture size, select [Off] on the [Zoom] menu.

Note:

This function may not work on some disc or titles.

Time Search **DVD** **BD** **AVCHD** **MPEG4**

To start playing at any chosen time on the disc:

1. Press DISPLAY during playback.
2. Press ▲ / ▼ to select the time clock icon and "--:--:--" appears.
3. Input the required start time in hours, minutes, and seconds from left to right. For example, to find a scene at 2 hours, 10 minutes, and 20 seconds, enter "21020" and press ENTER. If you enter the wrong numbers, press CLEAR to remove the numbers you entered. Then input the correct numbers.
4. Press ENTER to confirm. Playback starts from the selected time.

Note:

This function may not work on some disc or titles.

Skip Search **DVD** **BD** **AVCHD** **MPEG4**

You can skip the playback 15 seconds forward or backward using the search menu.

1. During playback, press SEARCH and the search menu appears on the screen.
2. Press ◀ / ▶ to skip the playback forward or backward.

Tip:

You can select a point that you want to skip by pressing and holding ◀ / ▶ button.

Marker Search **DVD** **BD** **AVCHD** **MPEG4**

To enter a Marker

You can start playback from up to nine memorized points. To enter a marker, press MARKER at the desired point on the disc. The Marker icon appears on the TV screen briefly. Repeat to enter up to nine markers.

To Recall or Clear a Marked Scene

1. Press SEARCH and the search menu appears on the screen.
2. Press a number button to select a marker number that you want to recall. Playback starts from the marked scene.

OR

Press ▼ to highlight a marker number. Use ◀ / ▶ to select a marked scene that you want to recall or clear.

Press ENTER and playback starts from the marked scene. Press CLEAR and the marked scene is erased from the search menu.

Notes:

- This function may not work on some disc or titles.
- All marked points are cleared if you press ■ (STOP) twice (complete stop), the title is changed or unload the disc.

Watching from a different angle

BD **DVD**

If the disc contains scenes recorded at different camera angles, you can change to a different camera angle during playback.

1. Press DISPLAY during playback.
2. Press ▲ / ▼ to select the angle icon then use ◀ / ▶ to select desired angle.

Last Scene Memory **DVD** **BD**

This unit memorizes last scene from the last disc that is viewed. The last scene remains in memory even if you remove the disc from the unit or switch off the unit. If you load a disc that has the scene memorized, the scene is automatically recalled.

Notes:

- Settings are stored in memory for use any time.
- This unit does not memorize settings of a disc if you switch off the unit before commencing to play it.
- Last Scene Memory function for a previous disc is erased once a different disc is played.
- This function may not work depending on the disc.

Using Color (R, G, B, Y) Buttons **BD**

These buttons are available only during BD-J contents playback. Use the appropriate buttons as indicated by the display. Depending on the disc contents, the functions of each button may differ.

Screen Saver

The screen saver appears when you leave the player in Stop mode for about five minutes. If the Screen Saver is displayed for five minutes, the unit automatically turns itself off.

Displaying Disc Information

On-Screen **DVD** **BD** **AVCHD** **MPEG4**

You can display various information about the disc loaded on-screen.

1. Press DISPLAY to show various playback information.
The items displayed differ depending on the disc type or playing status.

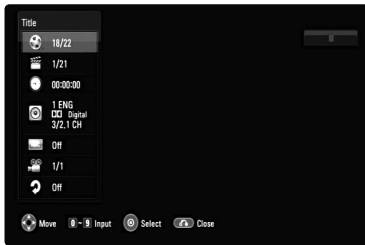

2. During BD-ROM or DVD playback, you can select an item by pressing ▲ / ▼ and change or select the setting by pressing ◀ / ▶.
 - Title/Track – Current title/track number/total number of titles/tracks.
 - Chapter – Current chapter number/total number of chapters.
 - Time – Elapsed playing time.
 - Audio – Selected audio language or channel.
 - Subtitle – Selected subtitle.
 - Angle – Selected angle/total number of angles.
 - Repeat – Selected repeat mode.

Notes:

- If no button is pressed for a few seconds, the on-screen display disappears.
- A title number cannot be selected on some discs.
- An item may not be available on some discs or titles.
- If BD interactive title is playing back, some setting information is displayed on the screen but prohibited to be changed.

Enjoying BD-LIVE™ or BONUS VIEW™ in BD-Video **BD**

This unit allows you to enjoy functions such as picture-in-picture, secondary audio and Virtual packages, etc., with BD-Video supporting BONUSVIEW (BD-ROM version 2 Profile 1 version 1.1/ Final Standard Profile). In addition to the BONUSVIEW function, BD-Video supporting BD-Live (BD-ROM version 2 Profile 2) that has a network extension function allows you to enjoy more functions such as online games by connecting this unit to the Internet.

Enjoying BD-Live discs with Internet

This unit supports BD-Live, a new BD-Video function that allows you to use the following interactive functions when connected to the Internet. (The usable functions and the operating method may vary with each disc. For details, refer to the instructions for the disc.)

- Additional contents such as movie's trailer, subtitles and BD-J, etc. can be downloaded to the USB Flash Drive to play them.
- Special video data, etc. may be played back while they are being downloaded to a USB Flash Drive.

Preparations:

- The unit must be connected to the Internet and set up to use the BD-Live functions (see page 16 and 22).
- A USB Flash Drive is required to use this function. Connect a USB Flash Drive (see page 10).
- The free space in the USB Flash Drive must be more than 1GB.
- Please connect USB Flash Drive before playback the Disc.

Caution:

- Do not extract the connected USB Flash Drive while content is being downloaded or a Blu-ray disc is still in the disc tray. Doing so may damage the connected USB Flash Drive and BD-Live features may not operate properly with the damaged USB Flash Drive anymore. If the connected USB Flash Drive seems damaged from such an action, you can format the connected USB Flash Drive from the PC and reuse it with this player.
- BD-Live on-line contents may not be downloaded because of insufficient space in the USB Flash Drive. In this case, please change USB Flash Drive with sufficient space or erase the data using [BD Storage Clear] option on the setup menu (See page 23 for details.)

Notes:

- Some BD-Live contents may be restrictively accessed in some territories by contents provider's own decision.

- It may take up to several minutes to load and start enjoying BD-Live contents.
- Depending on the disc, the BD-Live function may not be operated if [BD-LIVE connection] option is set to [Partially Permitted]. In this case, set [BD-LIVE connection] option to [Permitted] (See page 22.)
- The connection to the Internet may take time or the Internet may not be connected depending on the connection environment. It is required that you use a broadband connection.
- Do not remove the USB Flash Drive during operation. The USB Flash Drive may be damaged. Stop playback and turn off the menu beforehand.

Tip:

Special video data, etc. may be played back while they are being downloaded to a USB Flash Drive using one function of BD-Live. The playback may be paused depending on the communication environment.

Some functions may be disabled to prevent skipping to sections that have not been downloaded, etc.

AACS Online

When discs supporting BD-Live are played back, the player or disc IDs may be sent to the content provider via the Internet.

Services and functions to be provided differ depending on the disc.

- You can be introduced to other similar movies if you record your viewing history on the server by using these IDs.
- Game score histories can be saved.

Playing secondary video (picture-in-picture) and secondary audio

Secondary video can be played from a disc compatible with the picture-in-picture function.

For the playback method, refer to the instructions for the disc.

- To turn on/off secondary video, press PIP. Secondary video is played. Press the button to turn it ON or OFF.
- To turn on/off audio with the secondary video, press PIP AUDIO. The secondary audio is played. Press the button to turn it ON or OFF.

Notes:

- Discs may not always be played back according to the settings on this unit, as certain playback formats are prioritized on certain discs.
- Only the primary video is played during search/slow-motion or frame-by-frame.
- When the secondary video is turned off, the secondary audio does not play.
- This function may not work depending on the disc.

Playing a DVD VR Format Disc

This unit will play DVD-RW disc that is recorded using the Video Recording (VR) format.

1. Insert a disc and close the tray.
The [MOVIE] menu appears on the TV screen.



2. Press ▲ / ▼ to select a title then press ► (PLAY) and playback starts.
You can use variable playback functions.
Refer to pages 24-27.
3. Press DISC MENU to move to the list menu.

Notes:

- On the [MOVIE] menu, use red or blue button to move to the previous or next page.
- Unfinalized DVD-VR format discs may not be played in this player.
- Some DVD-VR disc are made with CPRM data by DVD RECORDER. This unit cannot support these kinds of discs.

What is CPRM?

CPRM is a copy protection system (with scramble system) only allowing the recording of 'copy once' broadcast programs. CPRM stands for Content Protection for Recordable Media.

MOVIE menu options

1. Use ▲ / ▼ to select a title on the [MOVIE] menu then press ENTER.
The menu options appear.
2. Use ▲ / ▼ to select an option, then press ENTER.



- **[Play]** Starts playback the selected title.
- **[Resume Play]** Starts playback from where you stopped it previously.
- **[Close]** Exits menu options. Also you can disappear it by pressing RETURN button.

Playing a MPEG4 Movie File

The player can play MPEG4 files. Before playing MPEG4 files, read "MPEG4 file requirement" on right.

1. Insert a disc containing MPEG4 files, or connect the USB Flash Drive containing MPEG4 files.
2. Press HOME and Home Menu appears.
3. Select [Movie] then press ENTER.
The [MOVIE] menu appears on the TV screen.

Note:

When the USB Flash Drive is connected and a disc is inserted simultaneously, the menu for selecting a media will appear. Select a media then press ENTER.



4. Press ▲ / ▼ to select a file then press ► (PLAY) and playback starts.
You can use variable playback functions.
Refer to pages 24-27.
5. Press DISC MENU to move to the list menu.

Note:

On the [MOVIE] menu, use red or blue colour button to move to the previous or next page.

MOVIE menu options

1. Use ▲ / ▼ to select a file on the [MOVIE] menu then press ENTER.
The menu options appear.
2. Use ▲ / ▼ to select an option, then press ENTER.



- **[Play]** Starts playback the selected file.
- **[Resume Play]** Starts playback from where you stopped it previously.
- **[Close]** Exits menu options. Also you can disappear it by pressing RETURN button.

Notice for displaying the MPEG4 subtitle

If the subtitle does not display properly, press and hold SUBTITLE for 3 seconds during playback. The language code will appear. Press ◀ / ▶ repeatedly to select another language code until the subtitle is displayed properly and then press ENTER.

MPEG4 file requirement

MPEG4 file compatibility with this player is limited as follows:

- Available resolution size: 1920 x1080 (W x H) pixels
- The file names of MPEG4 and subtitle are limited to 50 characters.
- MPEG4 file extensions: ".avi", ".mpg", ".mpeg", ".mp4", ".mkv"
- This unit does not support the DivX file.
- Playable MPEG4 subtitle: SubRip (.srt / .txt), SAMI (.smi), SubStation Alpha (.ssa/.txt), MicroDVD (.sub/.txt), SubViewer 2.0 (.sub/.txt), TPlayer (.txt), DVD Subtitle System (.txt)
- Playable Codec format: "XVID", "H.264/MPEG-4 AVC"
- Playable Audio format: "Dolby Digital", "DTS", "MP3", "WMA", "AAC"
- Sampling frequency: within 8 - 48 kHz (MP3), within 32 - 48 kHz (WMA)
- Bit rate: within 8 - 320 kbps (MP3), within 32 - 164 kbps (WMA)
- CD-R/RW, DVD-R/RW, +R/+RW, BD-R/RE Format: ISO 9660+JOLIET, UDF and UDF Bridge format
- Maximum Files/Folder: Less than 650 (total number of files and folders)
- Not all the WMA Audio format is compatible with this unit.
- This player support H.264/MPEG-4 AVC profile Main, High at Level 4.1.
For a file with higher level, the player will ask whether you want to play or not.
- Displaying subtitle file is not available for video files with ".mpg" and ".mpeg" extensions.
- HD movie files contained on the CD or USB 1.0/1.1 may not played properly. BD, DVD or USB 2.0 are recommended to play back HD movie files.

Playing an Audio CD or MP3/WMA files **ACD** **MP3** **WMA**

The player can play Audio CDs and MP3/WMA files. Before playing MP3/WMA files, read "MP3/WMA audio file requirement" on right.

1. Insert Audio CD or a disc containing MP3/WMA files, or connect the USB Flash Drive containing MP3/WMA files
2. Press HOME and Home Menu appears.
3. Select [Music] then press ENTER. The [MUSIC] menu appears on the TV screen.

Note:

When the USB Flash Drive is connected and a disc is inserted simultaneously, the menu for selecting a media will appear. Select a media then press ENTER.

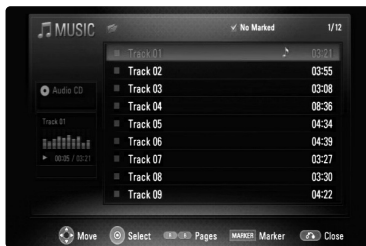

Example) Audio CD

4. Use ▲/▼ to select a track or file then press ► (PLAY). Playback starts. You can use variable playback functions. Refer to pages 24-27.
5. To stop playback at any time, press ■ (STOP).

Tips:

- To go directly to any track or file and play, enter the track/file number using the numbered buttons (0-9).
- The playback may start automatically if the Audio CD is inserted.
- Select a folder then press ENTER and you can view the files in the folder. If you want to move to the upper directory, use ◀ or ▲/▼ to highlight [UP Folder] and press ENTER.
- On the [MUSIC] menu, use red or blue button to move to the previous or next page.
- The equalizer indicator is not coupled with the music in play back.
- If there is impossible code to express in the file name, it may be displayed as illegible.

MUSIC menu options

1. Use ▲/▼ to select a track or file on the [MUSIC] menu then press ENTER. The menu options appear.

2. Use ▲/▼ to select an option, then press ENTER.

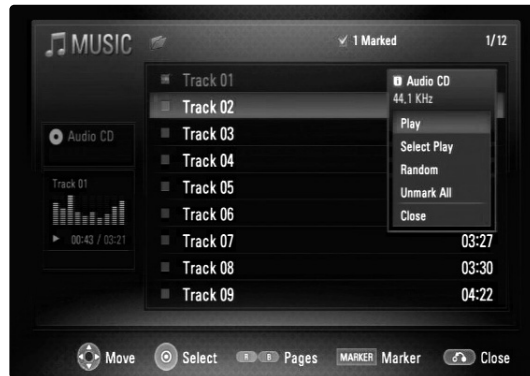

- **[Play]** Starts playback the selected track or file.
- **[Select Play]** Plays back only the marked track(s) or file(s). Use MARKER for selecting the multiple files or tracks. All marked tracks or files are cleared if you select [Play] option or press ► (PLAY) after selecting an unmarked track or file.
- **[Random]** Starts or stops random playback. By pressing ►► during random playback, the unit selects another track and resumes random playback.
- **[Unmark All]** Unmarks all marked files or tracks.
- **[Close]** Exits menu options. Also you can disappear it by pressing RETURN button.

Note:

You cannot use [Select Play] and [Random] functions simultaneously.

MP3/WMA audio file requirement

File extensions: ".mp3", ".wma"

Sampling frequency: within 8 - 48 kHz (MP3), within 32 - 48 kHz (WMA)

Bit rate: within 8 - 320 kbps (MP3), within 32 - 164 kbps (WMA)

CD-R/RW, DVD-R/RW, +R/+RW, BD-R/RE Format: ISO 9660+JOLIET, UDF and UDF Bridge format

Maximum Files/Folder:

Less than 650 (total number of files and folders)

Notes on MP3/WMA file

- Depending on the size and number of the MP3/WMA files, it may take several minutes to read the contents of the media.
- This unit cannot support the ID3 Tag embedded in the MP3 file.
- The total playback time indicated on the screen may not correct for VBR files.

Viewing a Photo file **PHOTO**

This unit can play photo files. Before playing photo files, read "Photo file requirement" on below.

1. Insert a disc containing photo files, or connect the USB Flash Drive containing photo files.
2. Press HOME and Home Menu appears.
3. Select [Photo] then press ENTER.
The PHOTO menu appears on the TV screen.

Note:

When the USB Flash Drive is connected and a disc is inserted simultaneously, the menu for selecting a media will appear. Select a media then press ENTER.



4. Use ▲▼◀▶ to select a file and press ENTER.
The selected image is displayed in full screen.



5. To stop viewing at any time, press ■ (STOP).
The PHOTO menu appears.

Tips:

- To go directly to any file and play, enter the file number using the numbered buttons (0-9).
- You can advance to the previous or next file by pressing ◀◀ or ▶▶ during viewing a photo file in full screen.
- You can start the slide show by pressing ▶ (PLAY) while the [PHOTO] menu appears. To start the slide show, choose the folder containing photo files or the photo file then press ▶ (PLAY).
- Select a folder then press ENTER and you can view the files in the folder. If you want to move to the upper directory, use ▲/▼/◀/▶ to highlight [UP Folder] and press ENTER.

- On the PHOTO menu, use red or blue color button to move to the previous or next page.
- If there is impossible code to express in the file name, it may be displayed as illegible.

Options during viewing a photo file in full screen

You can use various options during viewing a picture in full screen. Use ▲▼◀▶ to select an option and use the options as described below.

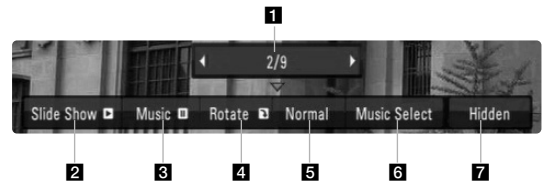

- 1 Use ◀▶ to advance to the previous or next file.
- 2 Press ENTER to start or pause the slide show.
- 3 Press ENTER to play or pause the background music. This option is available after the background music is selected using [Music Select] option.
- 4 Press ENTER to rotate the picture clockwise. This option is not available during slide show.
- 5 Press ENTER to set the Slide Show speed.
- 6 Selects the background music.
 - 1) Press ENTER and the menu will appear.
 - 2) Use ▲▼◀▶ to select a media or folder that there are music file(s).
 - 3) Press ENTER to confirm your selection.
- 7 Press ENTER to exit the option menu. To appear the menu again, press ENTER.

Photo file requirement

File extensions: ".jpg", ".jpeg", ".png", ".gif"

Recommended size:

Less than 3,000 x 3,000 x 24 bit/pixel

Less than 3,000 x 2,250 x 32 bit/pixel

CD-R/RW, DVD-R/RW, +R/+RW, BD-R/RE Format:
ISO 9660+JOLIET, UDF and UDF Bridge format

Maximum Files/Folder:

Less than 650 (total number of files and folders)

Notes on Photo file

- Progressive and lossless compression photo image files are not supported.
- Depending on the size and number of the photo files, it may take several minutes to read the contents of the media.

Reference

Language Codes

Use this list to input your desired language for the following initial settings: [Disc Audio], [Disc Subtitle] and [Disc Menu].

Language	Code	Language	Code	Language	Code	Language	Code
Abkhazian	6566	Fiji	7074	Lingala	7678	Singhalese	8373
Afar	6565	Finnish	7073	Lithuanian	7684	Slovak	8375
Afrikaans	6570	French	7082	Macedonian	7775	Slovenian	8376
Albanian	8381	Frisian	7089	Malagasy	7771	Somali	8379
Ameharic	6577	Galician	7176	Malay	7783	Spanish	6983
Arabic	6582	Georgian	7565	Malayalam	7776	Sudanese	8385
Armenian	7289	German	6869	Maltese	7784	Swahili	8387
Assamese	6583	Greek	6976	Maori	7773	Swedish	8386
Aymara	6589	Greenlandic	7576	Marathi	7782	Tagalog	8476
Azerbaijani	6590	Guarani	7178	Moldavian	7779	Tajik	8471
Bashkir	6665	Gujarati	7185	Mongolian	7778	Tamil	8465
Basque	6985	Hausa	7265	Nauru	7865	Tatar	8484
Bengali; Bangla	6678	Hebrew	7387	Nepali	7869	Telugu	8469
Bhutani	6890	Hindi	7273	Norwegian	7879	Thai	8472
Bihari	6672	Hungarian	7285	Oriya	7982	Tibetan	6679
Breton	6682	Icelandic	7383	Panjabi	8065	Tigrinya	8473
Bulgarian	6671	Indonesian	7378	Pashto, Pushto	8083	Tonga	8479
Burmese	7789	Interlingua	7365	Persian	7065	Turkish	8482
Byelorussian	6669	Irish	7165	Polish	8076	Turkmen	8475
Cambodian	7577	Italian	7384	Portuguese	8084	Twi	8487
Catalan	6765	Japanese	7465	Quechua	8185	Ukrainian	8575
Chinese	9072	Javanese	7487	Rhaeto-Romance	8277	Urdu	8582
Corsican	6779	Kannada	7578	Rumanian	8279	Uzbek	8590
Croatian	7282	Kashmiri	7583	Russian	8285	Vietnamese	8673
Czech	6783	Kazakh	7575	Samoan	8377	Volapük	8679
Danish	6865	Kirghiz	7589	Sanskrit	8365	Welsh	6789
Dutch	7876	Korean	7579	Scots Gaelic	7168	Wolof	8779
English	6978	Kurdish	7585	Serbian	8382	Xhosa	8872
Esperanto	6979	Laothian	7679	Serbo-Croatian	8372	Yiddish	7473
Estonian	6984	Latin	7665	Shona	8378	Yoruba	8979
Faroese	7079	Latvian, Lettish	7686	Sindhi	8368	Zulu	9085

Area Codes

Choose an Area code from this list.

Area	Code	Area	Code	Area	Code	Area	Code
Afghanistan	AF	Ethiopia	ET	Malaysia	MY	Saudi Arabia	SA
Argentina	AR	Fiji	FJ	Maldives	MV	Senegal	SN
Australia	AU	Finland	FI	Mexico	MX	Singapore	SG
Austria	AT	France	FR	Monaco	MC	Slovak Republic	SK
Belgium	BE	Germany	DE	Mongolia	MN	Slovenia	SI
Bhutan	BT	Great Britain	GB	Morocco	MA	South Africa	ZA
Bolivia	BO	Greece	GR	Nepal	NP	South Korea	KR
Brazil	BR	Greenland	GL	Netherlands	NL	Spain	ES
Cambodia	KH	Herd and McDonald Islands	HM	Netherlands Antilles	AN	Sri Lanka	LK
Canada	CA	Hong Kong	HK	New Zealand	NZ	Sweden	SE
Chile	CL	Hungary	HU	Nigeria	NG	Switzerland	CH
China	CN	India	IN	Norway	NO	Taiwan	TW
Colombia	CO	Indonesia	ID	Oman	OM	Thailand	TH
Congo	CG	Israel	IL	Pakistan	PK	Turkey	TR
Costa Rica	CR	Italy	IT	Panama	PA	Uganda	UG
Croatia	HR	Jamaica	JM	Paraguay	PY	Ukraine	UA
Czech Republic	CZ	Japan	JP	Philippines	PH	United States	US
Denmark	DK	Kenya	KE	Poland	PL	Uruguay	UY
Ecuador	EC	Kuwait	KW	Portugal	PT	Uzbekistan	UZ
Egypt	EG	Libya	LY	Romania	RO	Vietnam	VN
El Salvador	SV	Luxembourg	LU	Russian Federation	RU	Zimbabwe	ZW

Troubleshooting

Symptom	Possible Cause	Correction
No power.	<ul style="list-style-type: none"> The power cord is disconnected. 	<ul style="list-style-type: none"> Plug the power cord into the wall outlet securely.
The power is on, but the player does not work.	<ul style="list-style-type: none"> No disc is inserted. 	<ul style="list-style-type: none"> Insert a disc.
No picture.	<ul style="list-style-type: none"> The TV is not set to receive video signal output. 	<ul style="list-style-type: none"> Select the appropriate video input mode on the TV.
	<ul style="list-style-type: none"> The video cable is not connected securely. 	<ul style="list-style-type: none"> Connect the video cable securely.
	<ul style="list-style-type: none"> The selected resolution is not capable with your TV. 	<ul style="list-style-type: none"> Select another resolution using RESOLUTION button.
No sound.	<ul style="list-style-type: none"> The equipment connected with the audio cable is not set to receive disc signal output. 	<ul style="list-style-type: none"> Select the correct input mode of the audio receiver so you can listen to the sound from the player.
	<ul style="list-style-type: none"> The power of the equipment connected with the audio cable is turned off. 	<ul style="list-style-type: none"> Turn on the equipment connected with the audio cable.
	<ul style="list-style-type: none"> The [AUDIO] options are set to the wrong position. 	<ul style="list-style-type: none"> Set the [AUDIO] options to the correct position (see page 20).
	<ul style="list-style-type: none"> The player is in reverse play, fast forward, slow motion or pause mode. 	<ul style="list-style-type: none"> Return to the normal playback.
The player does not start playback.	<ul style="list-style-type: none"> The disc is upside down. 	<ul style="list-style-type: none"> Insert the disc with the playback side down.
	<ul style="list-style-type: none"> An unplayable disc is inserted. 	<ul style="list-style-type: none"> Insert a playable disc. (Check the disc type and regional code.)
	<ul style="list-style-type: none"> The rating level is set. 	<ul style="list-style-type: none"> Change the rating level.
	<ul style="list-style-type: none"> The disc was recorded on another unit and was not finalized. 	<ul style="list-style-type: none"> Finalize the disc on that unit.
BD-Live feature does not work.	<ul style="list-style-type: none"> A USB Flash Drive is not connected. 	<ul style="list-style-type: none"> Connect a FAT16 or FAT32 formatted USB Flash Drive to the USB port (see page 10).
	<ul style="list-style-type: none"> The connected USB Flash Drive does not have enough space. 	<ul style="list-style-type: none"> Secure at least 1GB free space in the USB Flash Drive for using BD-Live features.
	<ul style="list-style-type: none"> Internet connection is not established. 	<ul style="list-style-type: none"> Ensure that the unit is correctly connected to the local area network and can access the internet (see page 16).
	<ul style="list-style-type: none"> Your broadband speed is not fast enough to use the BD-Live features. 	<ul style="list-style-type: none"> Contact your Internet Service Provider (ISP) and increase the broadband speed is recommended.
	<ul style="list-style-type: none"> The [BD-LIVE connection] option in the [Setup] menu is set to [Prohibited]. 	<ul style="list-style-type: none"> Set the [BD-LIVE connection] option to [Permitted].
The Remote Control does not work properly.	<ul style="list-style-type: none"> The Remote Control is not pointed at the remote sensor on the player. 	<ul style="list-style-type: none"> Point the Remote Control at the remote sensor of the player.
	<ul style="list-style-type: none"> The Remote Control is too far from the player. 	<ul style="list-style-type: none"> Operate the Remote Control closer to the player.
The system does not function at all.	<ul style="list-style-type: none"> A state is unstable. 	<ul style="list-style-type: none"> Unplug the power cord and then plug the power cord again after more than five seconds.

Specifications

General

Power requirements:	AC 110-240 V~, 50/60 Hz
Power consumption:	18W
Dimensions (W x H x D):	Approx. 16.9 x 2.1 x 9.7 inches (430 x 54 x 245 mm) without foot
Net Weight (Approx.):	6.2 lbs (2.8 kg)
Operating temperature:	41 °F to 95 °F (5 °C to 35 °C)
Operating humidity:	5 % to 90 %

Outputs

VIDEO OUT:	1.0 V (p-p), 75 Ω, sync negative, RCA jack x 1
COMPONENT VIDEO OUT:	(Y) 1.0 V (p-p), 75 Ω, sync negative, RCA jack x 1 (Pb)/(Pr) 0.7 V (p-p), 75 Ω, RCA jack x 2
HDMI OUT (video/audio):	19 pin (HDMI standard, Type A)
ANALOG AUDIO OUT:	2.0 Vrms (1 kHz, 0 dB), 600 Ω, RCA jack (L, R) x 1
DIGITAL OUT (COAXIAL):	0.5 V (p-p), 75 Ω, RCA jack x 1
DIGITAL OUT (OPTICAL):	3 V (p-p), Optical jack x 1

System

Laser:	Semiconductor laser, wavelength: 405nm / 650 nm
Signal system:	Standard NTSC Color TV system
Frequency response:	20 Hz to 20 kHz (48 kHz, 96 kHz, 192 kHz sampling)
Signal-to-noise ratio:	More than 100 dB (ANALOG OUT connectors only)
Harmonic distortion:	Less than 0.008%
Dynamic range:	More than 95 dB
LAN port:	Ethernet jack x 1, 10BASE-T/100BASE-TX
Bus power supply:	DC 5 V $\overline{\text{---}}$ 500 mA
Accessories:	Video cable (1) Audio cable (1) Remote control (1) Batteries (1)

Note: Design and specifications are subject to change without prior notice.

The unit's Audio Output Specifications

Source	Jack/ Setting	Analog Output Stereo	SPDIF (DIGITAL AUDIO OUT)		
			PCM Stereo	DTS Re-encode *3	Primary Pass-Thru *1
Dolby Digital		PCM 2ch	PCM 2ch	DTS	Dolby Digital
Dolby Digital Plus		PCM 2ch	PCM 2ch	DTS	Dolby Digital
Dolby TrueHD		PCM 2ch	PCM 2ch	DTS	Dolby Digital
DTS		PCM 2ch	PCM 2ch	DTS	DTS
DTS-HD		PCM 2ch	PCM 2ch	DTS	DTS
Linear PCM 2ch		PCM 2ch	PCM 2ch	DTS	PCM 2ch
Linear PCM 5.1ch		PCM 2ch	PCM 2ch	DTS	PCM 2ch
Linear PCM 7.1ch		PCM 2ch	PCM 2ch	DTS	PCM 2ch

Source	Jack/ Setting	HDMI OUT			
		PCM Stereo	PCM Multi-Ch	DTS Re-encode *3	Primary Pass-Thru *1, *2
Dolby Digital		PCM 2ch	PCM 5.1ch	DTS	Dolby Digital
Dolby Digital Plus		PCM 2ch	PCM 7.1ch	DTS	Dolby Digital Plus
Dolby TrueHD		PCM 2ch	PCM 7.1ch	DTS	Dolby TrueHD
DTS		PCM 2ch	PCM 5.1ch	DTS	DTS
DTS-HD		PCM 2ch	PCM 5.1ch	DTS	DTS-HD
Linear PCM 2ch		PCM 2ch	PCM 2ch	DTS	PCM 2ch
Linear PCM 5.1ch		PCM 2ch	PCM 5.1ch	DTS	PCM 5.1ch
Linear PCM 7.1ch		PCM 2ch	PCM 7.1ch	DTS	PCM 7.1ch

Notes:

- *1 The secondary and interactive audio may not be included in the output bitstream if [SPDIF] or [HDMI] option is set to [Primary Pass-Thru]. (Except LPCM Codec : the output always include interactive and secondary audio.)
- *2 This player automatically selects the HDMI audio according to the decoding capability of the connected HDMI device even though [HDMI] option is set to [Primary Pass-Thru].
- *3 If the [HDMI] or [SPDIF] option is set to [DTS re-encode], the audio output is limited to 48 kHz and 5.1 Ch. If the [HDMI] or [SPDIF] option is set to [DTS Re-encode], the DTS Re-encode audio is outputted for BD-ROM discs with secondary audio or interactive audio. Otherwise the original audio is outputted for the other discs (like [Primary Pass-Thru]).
- The audio is outputted as PCM 48 kHz/16 bit for MP3/WMA file and PCM 44.1kHz/16 bit for Audio CD while playback.

Open source software notice

This product includes

- Freetype library : copyright © 2003 The FreeType Project (www.freetype.org).
- Zlib compression library: Copyright © 1995-2002 Jean-loup Gailly and Mark Adler.
- Expat library : copyright © 2006 expat maintainers.
- OpenSSL library :
 - cryptographic software written by Eric Young (eay@cryptsoft.com).
 - software written by Tim Hudson (tjh@cryptsoft.com).
 - software developed by the OpenSSL Project for use in the OpenSSL Toolkit. (<http://www.openssl.org>)

This product includes other open source software.

- Copyright © 1995, 1996, 1997 Kungliga Tekniska Hogskolan (Royal Institute of Technology, Stockholm, Sweden).
- Copyright © 1995-2008 International Business Machines Corporation and others
- Copyright © 1999, ASMUS, Inc.

Permission is hereby granted, free of charge, to any person obtaining a copy of this software and associated documentation files (the "Software"), to deal in the Software without restriction, including without limitation the rights to use, copy, modify, merge, publish, distribute, sublicense, and/or sell copies of the Software, and to permit persons to whom the Software is furnished to do so, subject to the following conditions:

THE SOFTWARE IS PROVIDED "AS IS", WITHOUT WARRANTY OF ANY KIND, EXPRESS OR IMPLIED, INCLUDING BUT NOT LIMITED TO THE WARRANTIES OF MERCHANTABILITY, FITNESS FOR A PARTICULAR PURPOSE AND NONINFRINGEMENT. IN NO EVENT SHALL THE AUTHORS OR COPYRIGHT HOLDERS BE LIABLE FOR ANY CLAIM, DAMAGES OR OTHER LIABILITY, WHETHER IN AN ACTION OF CONTRACT, TORT OR OTHERWISE, ARISING FROM, OUT OF OR IN CONNECTION WITH THE SOFTWARE OR THE USE OR OTHER DEALINGS IN THE SOFTWARE.

- HarfBuzz

IN NO EVENT SHALL THE COPYRIGHT HOLDER BE LIABLE TO ANY PARTY FOR DIRECT, INDIRECT, SPECIAL, INCIDENTAL, OR CONSEQUENTIAL DAMAGES ARISING OUT OF THE USE OF THIS SOFTWARE AND ITS DOCUMENTATION, EVEN IF THE COPYRIGHT HOLDER HAS BEEN ADVISED OF THE POSSIBILITY OF SUCH DAMAGE.

THE COPYRIGHT HOLDER SPECIFICALLY DISCLAIMS ANY WARRANTIES, INCLUDING, BUT NOT LIMITED TO, THE IMPLIED WARRANTIES OF MERCHANTABILITY AND FITNESS FOR A PARTICULAR PURPOSE. THE SOFTWARE PROVIDED HEREUNDER IS ON AN "AS IS" BASIS, AND THE COPYRIGHT HOLDER HAS NO OBLIGATION TO PROVIDE MAINTENANCE, SUPPORT, UPDATES, ENHANCEMENTS, OR MODIFICATIONS.

JVC