



**nostramo**  
***SpeedPad n52***



**User Guide**  
**F8GFC100**

## Table of Contents

	Page
Introduction	
Installing the Software . . . . .	.1
Assigning Profiles to Games in Loadout Manager . . . . .	.1
Nostromo Array Programming Software . . . . .	.2
Making a Profile . . . . .	.3
Creating a Macro . . . . .	.5
Other Remapping/Reprogramming Options . . . . .	.5
“Signing” and Sharing your Profile . . . . .	.6
Using the Profile Loadout Manager . . . . .	.7
Troubleshooting . . . . .	.8
User Guide for Mac® Users . . . . .	.9
Information . . . . .	.13

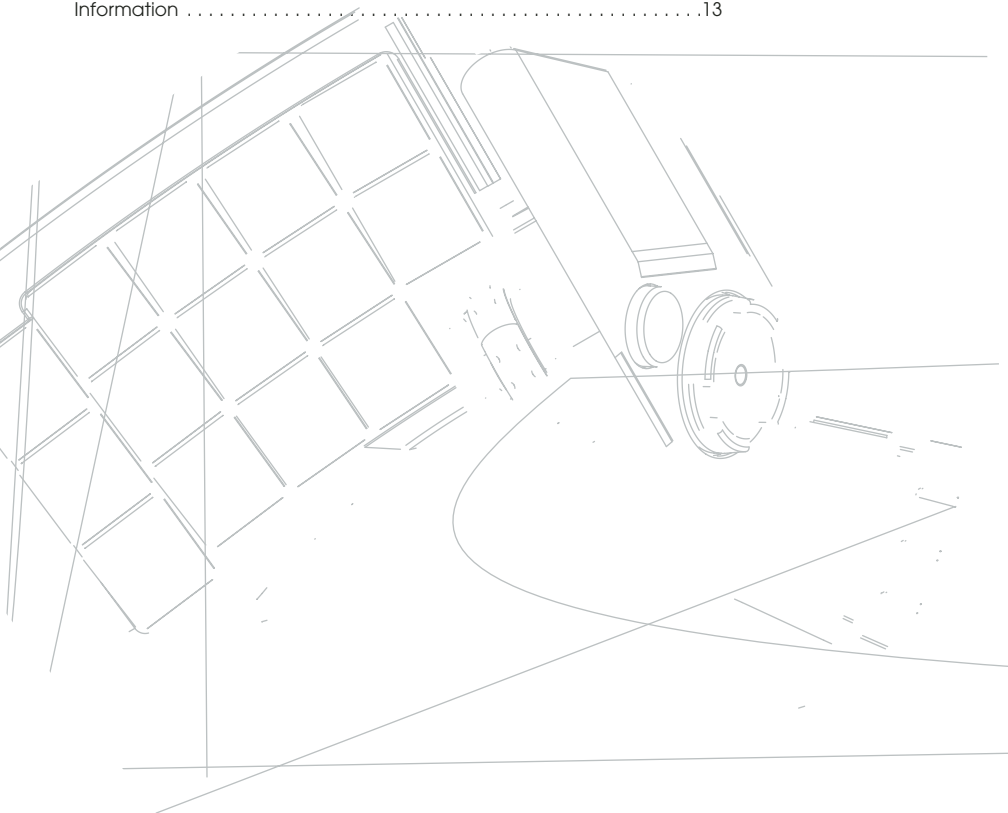

## INSTALLING THE SOFTWARE

### **Important Notes:**

**If you choose to install the n52 driver, you must install it prior to connecting the SpeedPad to your computer. If you choose not to install the n52 driver, please proceed to the "Using the SpeedPad as a default HID Device" at the end of this user guide.**

**If you have previously installed a driver for any Nostromo game controller, you must uninstall the old driver before proceeding with this installation procedure.**

1. Insert your Nostromo Array Programming Software into your CD/DVD drive on your computer.
2. The software should start automatically. If it does not, click the "Start" button and choose "Run". Click "Browse" and choose your CD drive. Select "setup.exe" and click "OK".
3. Follow the on-screen instructions to continue with the software installation.
4. After the installation is done, select "Finish". Connect the n52 to an available USB port on your computer.
5. Once installation is completed, please check to see if the installation was successful by proceeding to "Verifying Proper Installation".

### **Verifying Proper Installation**

1. You will need to confirm that the installation was successful through the device manager.
2. To get to Device Manager, right-click on "My Computer" and left-click on "Properties". Then left-click on "Hardware" and then on the "Device Manager" button.
3. Check to make sure that the Device Manager list includes
  - a) two new entries under Human Interface Devices, "Nostromo n52 HID SpeedPad 2.0" and "Nostromo n52 HID SpeedPad 2.0 Mouse Wheel".
  - b) a new entry under Keyboards, "HID Keyboard Device".
  - c) a new entry under Mice and Other Pointing Devices, "HID-Compliant Mouse".
4. Once you have confirmed that the installation was successful, you can either proceed to "Assign a Profile to a Game in the Loadout Manager" or "Making a Profile".

## ASSIGNING PROFILES TO GAMES IN LOADOUT MANAGER

The Nostromo Array Programming Software comes with premade profiles. Additional profiles are available for download at [www.belkin.com/nostromo](http://www.belkin.com/nostromo). To submit your own profiles, e-mail them as an attachment to [nostromoprofiles@belkin.com](mailto:nostromoprofiles@belkin.com). Please note that pre-built profiles are created by other gamers, which means you may not feel comfortable with the key layout for them. It is always recommended to create your own profiles so that the n52 is customized to your needs, according to the ways you play. To create your own profile, please check out the "Making a Profile" section in this User Guide before following the next steps.

1. Be sure you have the n52 connected to your computer before continuing.
2. Open the Loadout Manager by clicking on the Nostromo icon in the taskbar, your desktop, or in the Start menu under Program Files. Click on the bar (on the left) that shows your attached controller. Select "Load Profile" and then select the profile you want to use. The default location of pre-built profiles and website downloaded profiles are in the "pre-built" folder under "C:\Program Files\Belkin\Nostromo\Profiles". If you created one, the default location is right under "Profiles".
3. Then click "Browse" (on the right) and find the game executable (.exe) file you would like to use. You can select the game's shortcut from your desktop as an easier way of finding the path. If you don't have a link on your desktop, you can select the file by looking in the directory where you installed the game.
4. For more detailed information, please see the following "Nostromo Array Programming Software" section.

## NOSTROMO ARRAY PROGRAMMING SOFTWARE

### Introduction

The Nostromo Array Programming Software is a suite of tools that enhances your gaming experience when using the Nostromo SpeedPad n52.

The Nostromo Array Programming Software increases your play functionality and customization options. It allows you to remap your controller however you like, depending on which games you are playing.

There are two major components to the Nostromo Array Programming Software:

- The Profile Editor, which is used to create and change profiles. A profile is a set of mapped keyboard, mouse, and/or controller functions that can be saved and assigned to specific games.
- The Loadout Manager sets the profile to a certain program that can launch automatically or manually with the program. The Loadout Manager also gives you the ability to set a default profile that would launch with any program that does not have a profile assigned to it.

With this Software, you can:

- Create and save your customized profiles;
- Download/upload profiles via the Internet;
- Assign profiles to your favorite programs for use each time you start that program; and
- Set default profiles that would be active for everything on your computer that does not have a profile already set to it.

### Remap or Reprogram Buttons and Scroll Wheel 5 Ways

- Remap n52 buttons or scroll wheel to correspond to the keyboard keys.
- Reprogram buttons or scroll wheel to different controller ID buttons. (For games that identify controllers and have a certain key mapping for the game.)
- Remap buttons or scroll wheel with macros.
- Reprogram any of the buttons or wheel as a mouse click (left-, center-, right-click).
- Reprogram any of the buttons or scroll wheel to change shift states.

### Utilize 3 Shift States

Red, green, blue, and normal shift states quadruple the number of functions that can be programmed into the other buttons. There are different ways to set this.

- With the cycle shift option, one button or one direction of the scroll wheel will cycle through all the shift states.
- You can set the keys to work separately for red, green, and blue. You can create a toggle switch (which keeps the game in that shift state until pressed again), or momentary (stays in the shift state only as long as you hold down the key).

*Note: When shift state is not active, the game returns to its normal state.*

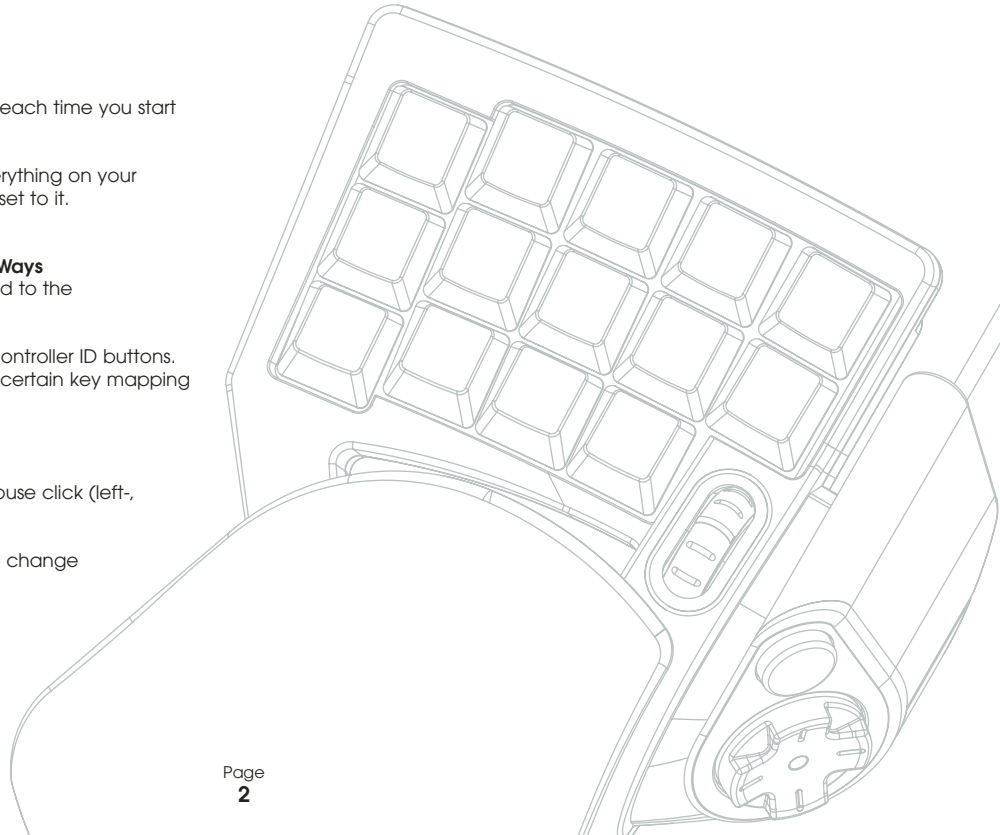

## MAKING A PROFILE

### Profile Editor

The Profile Editor is the tool used to create and customize profiles. A profile is a set of remapped button functions that can be saved.

Some examples of the types of actions you can program are:

**Single Key**—Make a button on the controller work like a keyboard key.

**Macros**—Record a sequence of keyboard keystrokes, mouse-button presses, and/or joystick commands (such as axis controls, d-pad controls, and joystick button commands) to be played back when a button is pushed.

**Remap Direct Input Buttons, Axis Controls**—Remap the buttons on the game controller to the Direct Input commands that are used within the game.

*Note: You would use this when playing a game that supports game controllers and you want to use its preset configuration.*

**Four Shift Modes**—Utilize one of three shift buttons for each game controller and quadruple the number of functions you can program.

**Mouse**—Program the game controller to function as a mouse click or scroll wheel.

### Main Screen of the Profile Editor

This figure shows the Profile Editor for the Nostromo SpeedPad n52.

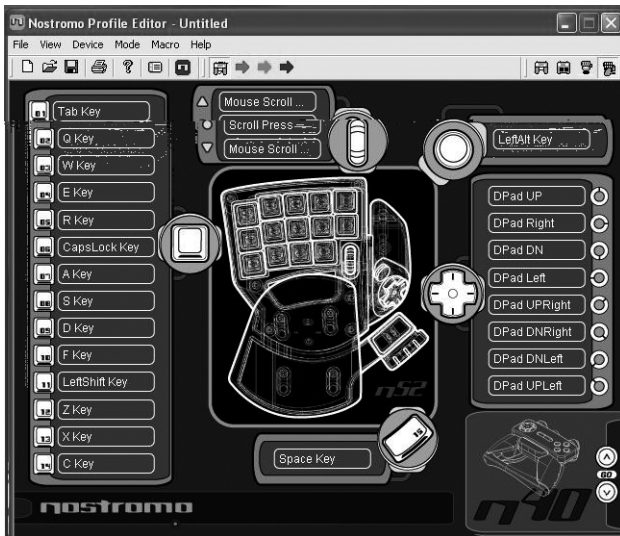

The main screen consists of:

**View of the Device**—This makes clear which keys you are programming.

### Menu Bar & Tool Bar

**Mode Bar**—This allows you to select between normal, red, green, and blue shift state modes.

**Controller Selection Corner**—This allows owners of multiple Nostromo devices to easily switch back and forth between controllers when programming.

**Function Assignment Hardpoints**—These are the buttons or axis identifiers, such as button "01", that you click to open your programming windows.

### Make a Profile

This section will explain how to create a profile using the Profile Editor. In general, creating a profile consists of the following functions: remapping single-key assignments, creating macros, setting mouse-control functions, programming control (direct input) function, and setting shift states.

To begin, click on "Start", then "Programs", then "Nostromo", then "Profile Editor". This will display the main screen of the "Profile Editor".

### Remapping Single-Key Assignments

1. Left-click on the hardpoint next to button "01" (labeled "Tab" by default).
2. Select "Single Key" from the pop-up menu. This will bring up the "Single Key Assignment" screen. This screen is used to select a single key to assign to one of the buttons on a Nostromo game controller. When a single key is assigned to a button, pushing the button is the same as pressing that key on the keyboard.

If this is the first time you have assigned a single key to one of the hardpoints, the screen will look like this:



3. At this point, press a key on the keyboard or the space bar. The screen will display the name of the key you pressed.
4. Notice that in addition to displaying the key you pressed, the edit window in the middle displays and highlights the same key name. You can elect to keep the default name, or type your own, such as "Fire Guns".

5. Now you can click “OK” if you are happy with the current setup, or you can click “Cancel” to abort the key assignment. You can also click “Record Key” to record a different key on the keyboard.

*Note: If you record a new key, any name you type in the edit box will be erased.*

### Macro Editor

To make a macro for a specific button, select another hardpoint, and select “New Macro”. A macro is a combination of buttons that enacts a special function. Additionally, in many games you can make a macro to send messages (“cover me” or “attack”, for example) with one button press.

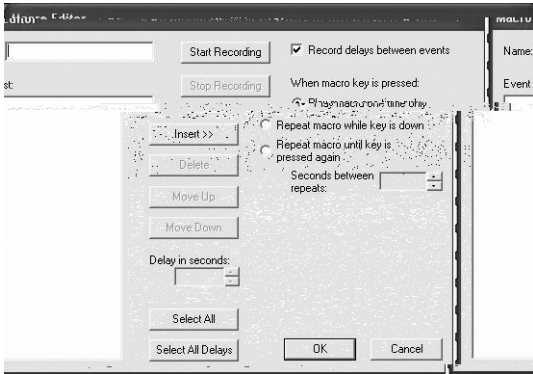

This screen is used to create macros. You can also use it to adjust properties of macros after they are recorded.

**Event Field**—As you record a macro, the keyboard commands that you type along with the actual delays between the events will start listing while you are typing in the “Event” panel on the left.

*Note: You cannot record joystick or mouse click commands during the recording phase. You can add them after you have completed the recording of all the single keys.*

**Start**—Starts the recording of a new macro.

**Stop**—As you probably guessed, this stops macro recording.

**Delay Adjust**—This control allows you to adjust the duration of a delay in the event list. Simply click on the delay in the event list that you want to adjust and then use the up and down arrow keys or number keys to change it.

**Record Delays Between Events**—This switch turns recording of delays on or off. A macro without recorded delays replays the events at the maximum possible rate, which is about 10 milliseconds between events. By default, this feature is on.

There are three settings to choose from under “when macro key is pressed”:

1. Play macro only one time.  
This is set by default and means that when you push or hold down the button assigned to it, it will run the macro only once. To reactivate it, you will have to push it again.
2. Repeat macro while key is down.  
This runs the same macro over and over when you hold the button down, until you release it.
3. Repeat macro until key is pressed again.  
This makes the macro command act like a toggle switch. If you push it once and let go, it will repeat the commands until you push it again to release the macro.

**Repeat Delay Adjust**—This control allows you to adjust the repeat rate. This next group of buttons is for modifying recorded macros.

**Insert:** This feature enables you to add commands that were missed during the recording or were not available during the recording.

1. Delay: Here you can add delays to your macro. By default they are set to 0.05 when added.
2. Keyboard: Here you can add a single key to your profile.
3. Mouse Button: Here you can set a left, right, or center mouse click to your macro.

The next six features are standard controls for game controllers and only work with games that support game controllers, and have a place for these commands.

1. Axis Up
2. Axis Centered
3. Axis Down
4. D-pad
5. Joystick
6. Throttle

**Delete:** Removes something in the macro that is not needed. Left-click what you want to remove and then left-click on “Delete”.

**Move Up:** If you want to move up a command in the event list, select the one you want to move with your mouse and left-click on “Move up” until it is in the desired position.

**Move Down:** If you want to move down a command in the event list, select the one you want to move with your mouse and left-click on “Move down” until it is in the desired position.

**Select All:** Highlights everything on the event list.

**Select All Delays:** This feature selects only the recorded delays in the event list. This is helpful if you want to make all the delays the same.

## CREATING A MACRO

1. Type a new name for the macro in the "Name" field at the top.
2. Left-click on the "Start" button to start recording keyboard events.
3. Using the keyboard, type in the key-press combination of the macro you want to create. This will normally be a combination of moves to create a new move, or a phrase, such as "cover me", that you would use during a game. Notice the keys you press and release are recorded in the "Event" field on the left side of the macro editor.
4. Left-click on the "Stop" button to stop recording the macro.
5. Click on the "OK" button. That saves your macro to the assigned button.

*Note that the "Delay Adjust" function allows you to adjust the time between each button press.*

You can even adjust the time delay between the finish and start of the macros while they are repeating with the "Adjust Delay Between Repeats" function at the bottom of the window.

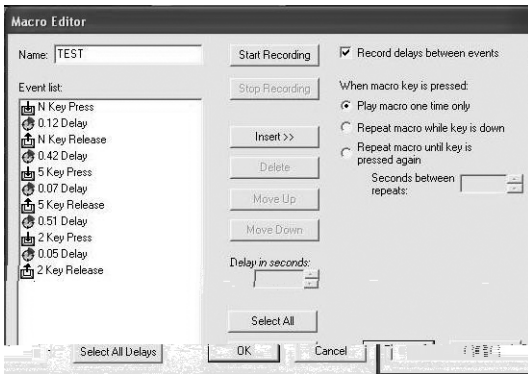

## OTHER REMAPPING/REPROGRAMMING OPTIONS

### Assigning a Direct Input Button to a Button

1. To assign a "Direct Input" button to a button on a Nostromo game device, simply left-click on the hardpoint you would like and select "DI Button". This will open the "Direct Input" window.
2. From the pull-down menu, select the "Direct Input" button that you would like to program to the selected button on the controller.
3. Select "OK" to remap the button.

### Assigning a Direct Input Axis to a Button

To assign a "Direct Input" axis to a button on a Nostromo game device, simply left-click on the hardpoint you would like and select "DI Axis Up" or "DI Axis Down". This will open the "Direct Input" window. From the pull-down menu, select the "Direct Input" axis that you would like to program to the selected button on the controller. Select "OK" to remap the button.

*Note: DI buttons and DI Axis can only be used for games or programs that can identify them. The types of games that this would be used with are sports or flight simulation games. Most first-person shooter games don't map with direct input commands by default.*

### Assigning a Mouse Button to a Nostromo Game Controller

To assign a mouse button to a button on a Nostromo game device, simply left-click on the button hardpoint you would like and select "Mouse Button". This will open the "Mouse Button" window. To reassign the left, center, or right button, simply select the circle of the mouse button you want to assign to your selected controller button. Select "OK" to remap the button.

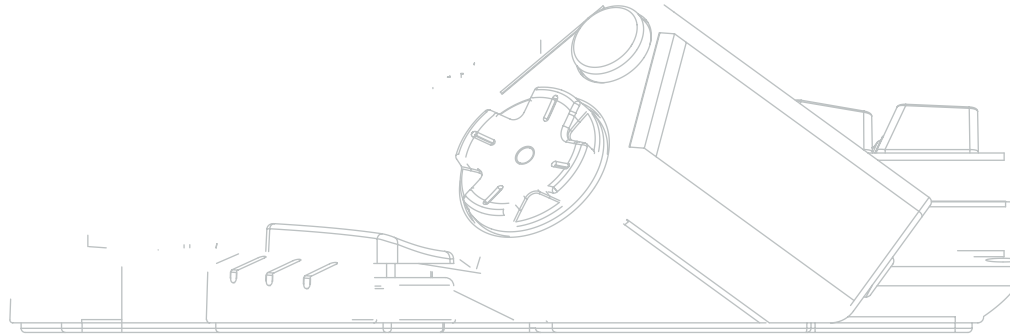
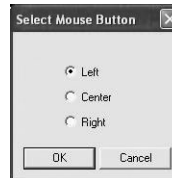



## Shift States

The Nostromo Array Programming Software allows you to program three shift states: red, green, and blue. A shift state allows you to add another layer of programming to each button. You can either set different keys for each of the shift states, or set one to cycle through all the different states. This cycle shift gives you the capability to have two extra buttons for each state. Basically, it frees up six buttons.

- To program shift states, you must choose one button for a cycle shift command or individual buttons for each of the shift states. In any shift state, that button will remain a shift button and cannot be remapped with a function.
- To program a key as a shift button, left-click on the button you would like to program and select red, green, or blue shift key or "Cycle Shift". For the red, green, and blue, you can select "Momentary" or "Toggle".
- If you select "Momentary", the shift function will only be in effect while you hold the button down. If you select "Toggle", pressing the shift button will start the programmed shift state and the controller will remain in that shift state until the shift button is pressed again.
- Once the button is assigned as a shift key, you must go to the corresponding shift window to assign the functions in that shift state.
- You can view different shift-state windows by clicking on the red, green, or blue arrows in the toolbar at the top. You can return to the original window by clicking on the "SpeedPad" icon.
- Once you are in the different shift-state windows, you can remap keys, create macros, and reprogram axes just as you did in the original shift state.
- Through use of these shift states, you can quadruple the programmability of each Nostromo game device. This will also allow you quick access to many functions during games while giving you the flexibility of assigning shift keys to any position on your Nostromo controller.
- Save your work.

*Note: It is always a good idea to get into the habit of saving your profiles by going to "File" and "Save As". This ensures that when you modify a profile that is used in a different game for another purpose, you won't simply overwrite it. This lets you keep your different profiles intact.*

## "SIGNING" AND SHARING YOUR PROFILE

In the "Profile Editor" toolbar, the icon between the question mark and the "Loadout Manager" icon is the "Contact Info" window. Click on that to get a window similar to this:

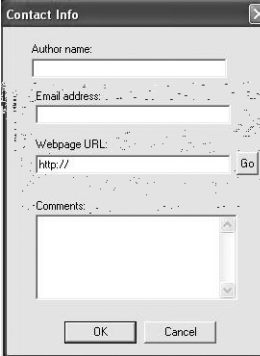

The screenshot shows a dialog box titled "Contact Info" with a close button (X) in the top right corner. It contains the following fields and controls:

- Author name:** A text input field.
- Email address:** A text input field.
- Webpage URL:** A text input field with "http://" pre-filled, followed by a "Go" button.
- Comments:** A multi-line text area with a vertical scrollbar.
- Buttons:** "OK" and "Cancel" buttons at the bottom.

By filling in this window, you get something similar to a name tag for your profile. You can have the profile identified as yours, including your comments, e-mail address, etc. for the Nostromo community.

Once your profile is saved and identified, you can submit it to the Belkin Nostromo team by e-mailing the profile in an e-mail attachment to [nostromoprofiles@belkin.com](mailto:nostromoprofiles@belkin.com) for inclusion on the Belkin website. This way, you can have your unique profile and/or loadout file made available to other users of Nostromo game devices throughout the world.

When you are finished creating or editing your profiles, left-click on the "File" menu on the toolbar and select "Save" or "Save As". The default name is "Untitled". Give it an easily identifiable name (for the next time you retrieve it), and click "OK".

Your profile is saved in C:\Program Files\Belkin\Nostromo\Profiles. If you installed to a directory other than C:\ProgramFiles\Belkin\Nostromo, then the profile is saved in YourInstallDirectory\Profiles.

### Uploading and Downloading Profiles

Please submit any profiles you create for addition to the profile list at [belkin.com](http://belkin.com). To submit a profile, please send it as an e-mail attachment to [nostromoprofiles@belkin.com](mailto:nostromoprofiles@belkin.com).

To download profiles, go to [belkin.com/nostromo](http://belkin.com/nostromo) and click on "Downloads".



## USING THE PROFILE LOADOUT MANAGER

The Loadout Manager is responsible for “programming” the game controllers with profiles. The Loadout Manager can be used in two modes: manual and automatic.

A loadout is a set of profiles that are assigned to the Nostromo game controllers on your system (one profile for each controller), and an associated game (or really any application). Loading that game causes the Loadout Manager to automatically load the profiles you’ve set up. This conveniently enables you to create profiles that will be associated with each game you play. The system will automatically load those profiles for you as you start up each game.

Loadouts are built with the Loadout Manager. You assign a profile for each controller, and select a game to associate with the set of profiles.

**Manual Mode**—Manual Mode is the simplest way to use the Loadout Manager. In this Mode, you directly select profiles for controllers. You simply open the activator window and select a profile for each controller it shows.

**Automatic Mode**—In Automatic Mode, you set up a loadout for each game. The Loadout Manager then waits for that game to start. When it does, the Loadout Manager loads all the profiles associated with that loadout.

Automatic Mode has a complex initial setup, but once that is done, you never need to think about it again. Simply launch the game you want to play and the Loadout Manager makes sure the controllers are configured the way you want them to be.

### Load the Profile you Just Made

After making a profile, you will need to activate it with a game in the Loadout Manager. To do this, you simply select the controller, the profile, and the game executable file. Then you can easily launch the game from within the Loadout Manager.

Open the Loadout Manager.

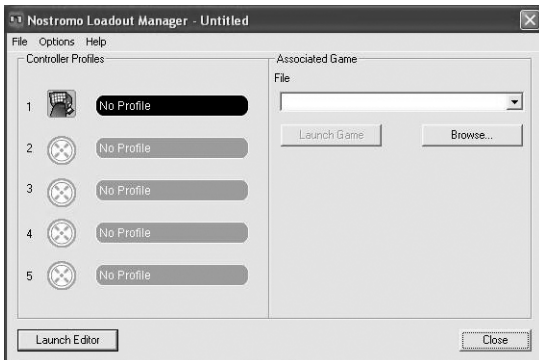

If the Loadout Manager is currently running, there will be an icon in the system tray on the right side of the taskbar at the bottom of the desktop:

If the Loadout Manager is not running, you can start it from the “Start” menu: “Start>Programs>Nostromo->Loadout Manager”.

- Find the controller you want to load the profile for in the list shown. If you have more than one of a type of controller, and it’s not obvious which entry on the screen represents which controller, simply press a couple of buttons on the controller and the image representing that particular one will light up.
- Click on the profile button for that controller. Select “Load Profile...” from the menu. This will bring up the typical file selection window.
- Find the profile you want, select it, and click “OK”.
- On the right half of the Loadout Manager, click “Browse” to select the executable (.exe) file of the game you want to play. You can do this by selecting the shortcut for the game on your desktop if you have one there. If you do not, you can find the file in the directory where you installed your game.
- Once you have the Programs.exe (or executable) selected, you can either left-click on “Launch Game” or go to “File” and “Save as” and name it. Save the loadout to use in Automatic Mode later.
- If you choose to use it in Automatic Mode, then you will need to switch to Automatic from Manual by going to “Option” at the top left corner of the editor.

Under “Options” there are a few different features that you can also use.

- Automatic Mode: Allows the profile to launch automatically when the program is activated.
- Manual Mode: If you select this, you will need to manually launch the profile through the loadout manager each time you use it.
- Set as default loadout: You can set a profile to launch with every application that does not have a profile set to it already.
- Clear default loadout: This will remove any default loadout that is active on the system.
- Run on system start: If you uncheck this, the Loadout Manager will NOT load at system startup.

## TROUBLESHOOTING

### When I start the game with the Loadout Manager, there is no response or control from my SpeedPad n52.

- Check the status in the "Game Controller" icon in the Control Panel (click "Start", "Control Panel", "Game Controllers"). Make sure the controller is listed in the "Game Controller" panel and the status is listed as "OK".
- In your game, make sure the keyboard is selected as the default controller.
- Make sure your controller cable is connected properly.
- In the Windows "Control Panel/Game Controllers" window, make sure the window shows the name of your Nostromo controller and "OK". If you don't see this line, or if it says "not connected", unplug the controller and uninstall the software and drivers. Then reboot, reinstall the software, and plug in the controller.
- Check to be sure you know which button assignments you have set up

### After using the Loadout Manager, Windows is acting erratically, as if a keyboard button was constantly pressed.

#### The button functions are not what they should be in the profile I am using:

- Check to see if the original keyboard assignments within the game options have been changed. If the original keyboard key assignments in the game have changed, it will affect your profile because your profile functions are based on keyboard functions.

### In Windows 2000, the Nostromo drivers did not load and the controller is only being recognized as an HID device.

- Unplug the controller.
- Uninstall any Nostromo software, including device drivers.
- Restart the computer.
- Plug in the Nostromo game device you want to use. Allow the device to install without the Nostromo Software Interface CD.
- While the controller is still plugged in, install the software interface and drivers on the CD.

### The game freezes.

- Restart your computer.

### The n52 is not in the Windows Control Panel.

- Unplug your n52, and uninstall the software and drivers. Then reboot, reinstall the software, and plug in the unit. If you are using Windows 2000, be sure to plug in the n52 before rebooting.

If you are still having problems, contact Belkin Tech Support at the numbers listed on the back cover. First make sure that the problem you are having is related to the Nostromo game controllers and the Nostromo Array Programming Software, and is not an issue with the game you are playing. If you are having problems with the game, please contact the game publisher directly.

### Using the SpeedPad as a Default HID Device

If you choose not to install the software or don't set a profile to a game, then by default, your n52 will map like this:

- |  |                                     |
|--|-------------------------------------|
| 1. Tab   | D-pad are the keyboard's arrow keys |
| 2. Q   | Thumb pad is the "Space" key        |
| 3. W   | Thumb button is the "ALT" key       |
| 4. E   |                                     |
| 5. R   |                                     |
| 6. CAPS  |                                     |
| 7. A   |                                     |
| 8. S   |                                     |
| 9. D   |                                     |
| 10. F  |                                     |
| 11. SHIFT  |                                     |
| 12. Z  |                                     |
| 13. X  |                                     |
| 14. C  |                                     |
| 15. By default, the scroll wheel acts like a standard mouse scroll wheel with a third mouse click. |                                     |

This configuration works well with the default keyboard setup of most first-person shooter games.

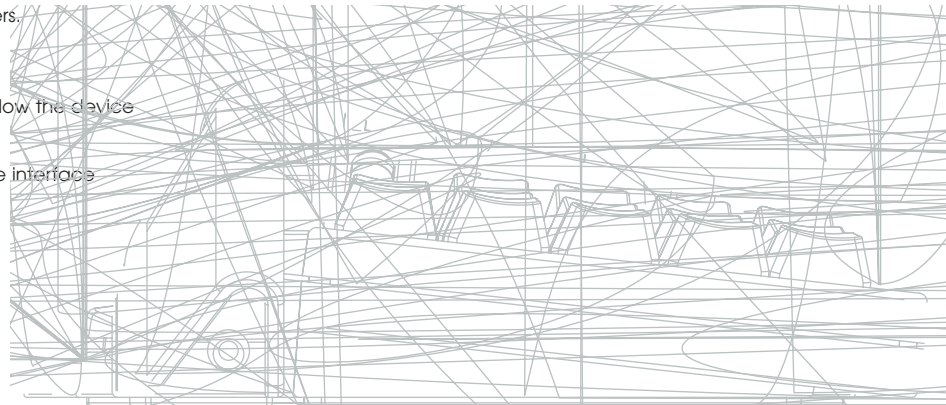

## USER GUIDE FOR MAC® USERS

### CHOOSING AN APPLICATION

The software loads a profile based on the settings and the currently running application. If no profile exists for the current application, the software uses the “Global Settings” profile. The Global Settings profile applies to all applications that do not have a profile specifically assigned to them.

#### Profiles

A profile is a mapped set of button-presses on the controller that accomplishes various actions. Some examples of the types of actions you can program are:

- Single Key—make a button on the controller work like a keyboard key.
- Macros—record a sequence of keyboard keys to be played back when a button is pressed.
- Three shift modes—the controller can have three shift buttons that quadruple the number of functions that can be programmed into the other buttons.
- Mouse—the game controller can be programmed to insert mouse clicks.

See the “Tutorial” section for a walk-through creating a profile. See the “Interface Reference” section for a description of the interface and its functionality.

### TUTORIAL

#### Building a Simple Profile

We will walk through a simple example of how to use the tool to create profiles using Nostromo Array Programming Software (NAPS).

*Note: This example does not cover every feature of the software. You can find more information in the “Main Interface” section.*

*Note: All screen shots are from the Mac OS X version of the software. The interface is the same in Mac OS 9 and the controls are in the same places.*

#### Start the Nostromo Array Programming Software Application

On Mac OS X, this is installed into your applications directory; in Mac OS 9, this is in your Control Panels menu. This will display the Main Screen of NAPS.

#### Select an Application

The “Target” pop-up menu determines which profile applies to which application.

1. Select “New Settings...” from the “Target” pop-up; a dialog will appear asking what to use as the base setting.
2. Select “Create Empty Settings” to start with a blank slate.



The Nostromo Array Panel will bring up a standard file chooser. In Mac OS X, find and select “TextEdit” in your Applications folder. In Mac OS 9, find and select “SimpleText”.

#### Assign a Single Key Event

1. Click on the Button 01 hardpoint or press button 01 on the controller. This will change the “Trigger” pop-up to “Button 01”. The “Trigger” pop-up indicates which button on the controller we are assigning the action to.
2. The “Action” pop-up is set to “Type Keystroke” by default. This indicates that we want the controller to simulate a keyboard key-press when we hit the control listed in “Trigger”. This is correct.
3. Click in the “Keystroke” area. The Control Panel will highlight this box and wait for you to press a key. Press “a”.
4. The “Frequency” pop-up determines how that key acts. The default is “Hold Down”. Hold Down indicates that the key will be held as long as you hold the button on the controller. This is correct.

#### Assign a Macro

A macro is a series of keystrokes that get played back when the triggering controller button is pressed.

1. Click on the Button 02 hardpoint or press button 02 on the controller. This will change the “Trigger” pop-up to “Button 02”.
2. Change the “Action” pop-up to “Run Macro”.
3. In the “Macro” pop-up, select “New Macro...”. This will bring up the “Edit Macro” dialog.
4. Enter “My Macro” as the name for this macro.
5. Tab to the first “Keystroke” edit control.
6. Type “hi there”. These keys will be filled in the various keystroke boxes. If you make a mistake, hit the “Clear” button and try again.

7. All the other controls default to values that we want; select “OK” to accept this macro.

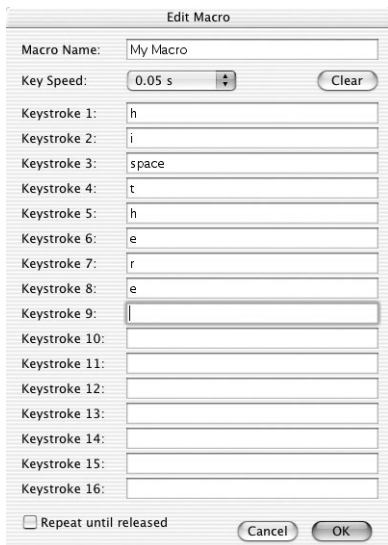

### Test your Profile

Notice that the hardpoints that you have assigned actions to now have text that describes what that button will do. You have assigned the “a” key to game controller button 01 and the “My Macro” macro to game controller button 02.

Start the application that is associated with this profile. This is TextEdit in Mac OS X or SimpleText in Mac OS 9.

Press button 01 on the n52 and notice that an “a” appears in the editor. Press and hold button 01 and notice that it repeats, just like holding a key on the keyboard.

Press button 02 on the n52 and notice that the “hi there” you assigned as the macro gets typed into the window.

### Make a Global Profile

When you run an application, and you have not created a profile for it, it uses the “Global Settings” profile. This tutorial describes creating a Global Profile. The Global Profile tutorial is written under the assumption that you have read and followed the “Building a Simple Profile” tutorial.

### Select Global Settings

Switch the “Target” pop-up to “Global Settings”.

### Set Controls

Use the methods you learned earlier to set button 01 to report as “b”. Use the methods you learned earlier to set button 02 to report as a macro that produces “hello”.

### Test Global Profile

Open any application other than the application you have a specific profile for. Use button 01 and button 02. The settings from your global profile are used. Open the application you have a specific profile for; this is SimpleText in Mac OS 9 and TextEdit in Mac OS X. Now try button 01 and button 02. The settings from your application-specific profile are used.

## INTERFACE REFERENCE

### Main Interface

The Nostromo Array control panel is used to create a profile for a Nostromo game controller and to associate those profiles with applications.

The top of the window has a view of the controller and hardpoints for each of the assignable controls. The bottom of the window contains the mapping controls.

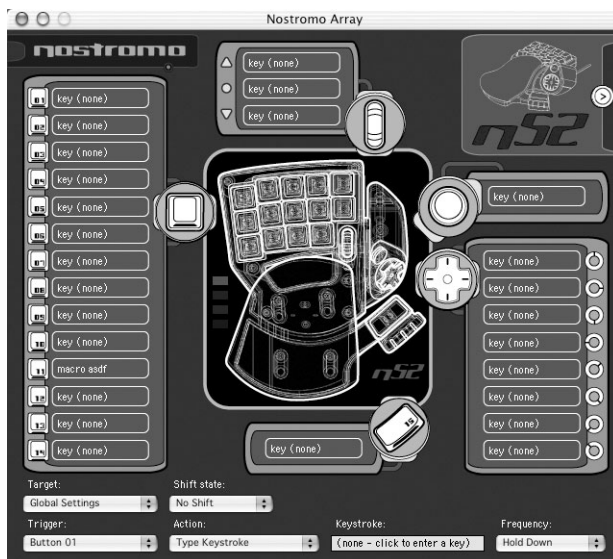

### Hardpoint

“Hardpoint” is our name for each assignable control on the n52. There is one hardpoint for each button, one for each d-pad direction, one for scroll up, one for scroll down, one for the scroll wheel button, and one for both thumb buttons. Each hardpoint has text that describes the action that will happen when that control is hit. Clicking on a hardpoint selects that control as the control to be edited in the trigger pop-up.

### **No Device Found**

This indicator is shown when the software does not detect an n52 plugged into your Mac computer. You can still create profiles if there is no n52 plugged into the computer. If the controller is plugged in and the software does not detect it, try unplugging the controller, and then plugging it in again.

### **Device Selection Box**

In the upper right corner of the interface is the device selection box. Press the arrow to edit settings for other controller.

### **Mapping Controls**

The mapping controls section of the window allows the user to edit controls and associate the profile with an application.

### **Target**

The "Target" pop-up lists the application whose profile is currently displayed.

In addition, the "Target" pop-up contains the controls for selecting which application to associate a profile with, and exporting and importing profiles.

1. **Global Settings:** This is a special profile that is in effect when the running application does not have a specific profile associated. The Global Settings profile does not have an associated application, all other profiles do.
2. **New Settings....:** The New Settings entry creates a new profile associated with a new application. It asks if you want to start from an empty profile, copy the Global Settings, or copy the profile you are

11. Hold Shift State: This action causes pressing the triggering control to enter the appropriate shift state. The controller remains in that shift state until the triggering control is pressed a second time.
12. Scroll Direction: This scrolls in the selected direction.

### Action - Type Keystroke

When "Type Keystroke" is selected as the action, you have two additional options.

#### Keystroke

The "Keystroke" box is where you enter the key to report for the Type Keystroke action. Select this box and press the key you want. You can also add modifier keys here by holding the modifier key you want as you press the key.

#### Frequency

The "Frequency" pop-up details how the key is reported to the system.

1. Once: This indicates the system will act as if the key is pressed and released once. The keystroke will not be reported again until the control is released and re-pressed.
2. Hold Down: This indicates the software will report the key held down as long as the triggering control is held down.
3. N times/sec: The software will report the key being pressed and released very quickly.
4. Every N seconds: The software reports the key being pressed and released as listed, once every N seconds.

### Action - Press Modifier Keys

When "Press Modifier Keys" is selected as the action, you have the additional option of selecting which modifier keys to press. Select the modifier keys you want pressed by clicking on the appropriate button.



### Action - Open File or Folder

When "Open File" or "Folder" is selected as the action, you have the additional option of selecting what to open. Click the "Item to Open" control to bring up a standard file chooser, then choose the item you want opened when the triggering control is pressed.

### Action - Run Macro

When "Run Macro" is selected as the action, you have the additional options of creating or choosing which macro to run.

### Macro Pop-Up

The macro pop-up is how you manage macros.

1. No Macro Selected: This is the default. No macro has been selected yet. You cannot choose this option; it exists to indicate that you need to select a macro.

2. New Macro...: This brings up the Edit Macro dialog empty, so that you can enter a new macro.
3. Edit Macro...: This brings up the Edit Macro dialog with the current macro so that you can edit it.
4. Delete Macro...: This deletes the current macro.
5. Macros by Name: The pop-up lists the existing macros by name. Selecting one sets it as the macro for this action.

### Action - Mouse Click

When one of the "Mouse Click" actions is selected, you have the additional option of selecting which modifier keys to report at the same time. Select the modifier keys you want pressed by clicking on the appropriate button.

### Action - Scroll Direction

When one of the "Scroll" actions is selected as the action, you have two additional options.

#### Scroll Speed

The "Scroll Speed" pop-up lets you select how far to scroll when this action is activated.

#### Frequency

The "Frequency" pop-up details how often the key is reported to the system. This behaves just like the frequency selection of the "Type Keystroke" action.

### Edit Macro Dialog

The Edit Macro dialog is where you edit the macros you want to use.

1. Macro Name: Macros need names to distinguish them from each other; enter the name here.
2. Key Speed: The Key Speed is the time between reported key presses. If the macro repeats, this is also the time between the last key press and the first.
3. Clear: This erases the keystrokes recorded for this macro.
4. Keystroke List: This is the list of keystrokes that the software will report while this macro is running. You can select any box and type a key to replace the key in that position. You can have the macro report modifier keys by pressing them with the key to report.
5. Repeat until released: When this box is checked, this macro will restart from the beginning if the triggering control is still pressed. If this box is not checked, the macro will stop when it reaches the end of the keystroke list, even if the triggering control is still pressed.

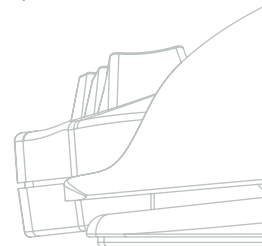

## GLOSSARY

### Action

The effect the software produces when a trigger is pressed.

### Hardpoint

A hardpoint is a button on the software interface that represents a single physical control on the n52. Click on a hardpoint to select it for programming.

### Macro

A macro is a set of keystrokes that are played in sequence when triggered.

### Profile

A profile is a collection of mappings between triggers and actions. Most profiles are associated with a specific application. Global Settings is a special profile that applies when no other profile is associated with the current application.

### Shift State

A shift state is a way of putting more than one function on a single button of the n52. There are four shift states available: Normal, Red, Green, and Blue. If no LEDs light up, then Normal mode is indicated. An LED of the appropriate color indicates the other modes. Any control on the n52 can activate a shift state. These can either be active while that control is held, or toggled on and off by using that control. Controls can have different functions in each shift state. For example, in Normal mode, button 01 might act like the letter "a" on the keyboard; while in Blue mode, button 01 runs a macro.

### Trigger

A trigger is any control on the n52 that triggers an action.

## INFORMATION

### FCC Statement

#### DECLARATION OF CONFORMITY WITH FCC RULES FOR ELECTROMAGNETIC COMPATIBILITY

We, Belkin Corporation, of 501 West Walnut Street, Compton, CA 90220, declare under our sole responsibility that the product,

#### F8GFPC100

to which this declaration relates,

Complies with Part 15 of the FCC Rules. Operation is subject to the following two conditions: (1) this device may not cause harmful interference, and (2) this device must accept any interference received, including interference that may cause undesired operation.

### CE Declaration of Conformity

We, Belkin, declare under our sole responsibility that the F8GFPC100, to which this declaration relates, is in conformity with Generic Emissions Standard EN55022 1998 and with Generic Immunity Standard EN55024 1998, and with low voltage directive.

**Note:** If during the use of this product the host computer becomes unresponsive, it may be due to electrostatic discharge. Please follow the procedures below to correct the problem:

- Disconnect the USB cable from the computer;
- Close the software application in the computer (or reboot the computer if necessary); and
- Reconnect the USB cable to the computer.

### Belkin Corporation Limited Lifetime Warranty

Belkin Corporation warrants this product against defects in materials and workmanship for its lifetime. If a defect is discovered, Belkin will, at its option, repair or replace the product at no charge provided it is returned during the warranty period, with transportation charges prepaid, to the authorized Belkin dealer from whom you purchased the product. Proof of purchase may be required.

This warranty does not apply if the product has been damaged by accident, abuse, misuse, or misapplication; if the product has been modified without the written permission of Belkin; or if any Belkin serial number has been removed or defaced.

THE WARRANTY AND REMEDIES SET FORTH ABOVE ARE EXCLUSIVE IN LIEU OF ALL OTHERS, WHETHER ORAL OR WRITTEN, EXPRESSED OR IMPLIED. BELKIN SPECIFICALLY DISCLAIMS ANY AND ALL IMPLIED WARRANTIES, INCLUDING, WITHOUT LIMITATION, WARRANTIES OF MERCHANTABILITY AND FITNESS FOR A PARTICULAR PURPOSE.

No Belkin dealer, agent, or employee is authorized to make any modification, extension, or addition to this warranty.

BELKIN IS NOT RESPONSIBLE FOR SPECIAL, INCIDENTAL, OR CONSEQUENTIAL DAMAGES RESULTING FROM ANY BREACH OF WARRANTY, OR UNDER ANY OTHER LEGAL THEORY, INCLUDING BUT NOT LIMITED TO, LOST PROFITS, DOWNTIME, GOODWILL, DAMAGE TO OR REPROGRAMMING OR REPRODUCING ANY PROGRAM OR DATA STORED IN OR USED WITH BELKIN PRODUCTS.

Some states do not allow the exclusion or limitation of incidental or consequential damages or exclusions of implied warranties, so the above limitations of exclusions may not apply to you. This warranty gives you specific legal rights, and you may also have other rights that vary from state to state.

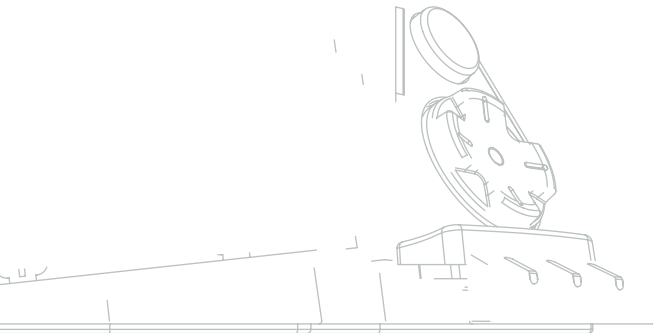



nostromo

*Speed*

