

XO VISION[®]

USER MANUAL



X348NT



• TOUCH SCREEN • 1-DIN 7" TFT LCD • DVD PLAYER

MADE IN CHINA



Contents

Warning and Precautions.....	2	Radio Operation.....	12
Electric Connection.....	4	Band	
Reception collection		Band tuner	
Speaker collection		AS/PS	
Installation.....	5	Sound Operation.....	14
Install the unit		SD/USB.....	15
Remove the unit		Bluetooth.....	16
General Features.....	6	TV Operation.....	18
Remote Control.....	7	Accessories.....	19
Loading and Replacing the battery		AV input Operation.....	20
Basic operation		Troubleshooting.....	21
Play Operation.....	9	Familiar characters and their meanings	
Open/Close		General problems	
Source/Power		TFT Monitor	
Mute		Radio Tuner	
play/pause		Mp3 playback	
Eject		DVD player	
RPT		Specifications.....	26
TIT			
TFT-LCD adjustment			
Display position adjustment			
Setup Operation.....	11		
General operation			
Video operation			
Audio operation			

Warnings and Precautions

Warnings

- 1、 Only connect the unit to a 12V power supply with negative grounding.
- 2、 Never install the unit where the operation for safety driving is restrained.
- 3、 Never use the video display function in the front when driving to prevent the violation of laws regulations and also to reduce the risk of traffic accident except using for rear view video camera.
- 4、 Never expose the unit, amplifier, speakers to moisture or water to prevent electronic sparks or fires.
- 5、 Please don't change the fuse in the power cord without professional guidance, improper fuse may cause damage to this using unit or even cause fire.
- 6、 Please power off the unit at once and send it back to the after-sales service center or the dealer/distributor yo purchased from if one of the following symptoms is found:
(a)NO audio output; (b)NO image output;(c)Water or other obstacle enters the unit; (d)Smoking;
(e)Peculiar smell.
- 7、 To ensure safe driving, please adjust the volume to a safe and comfort level in case of emergency situations.

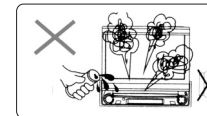
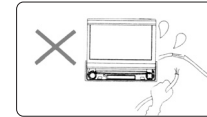
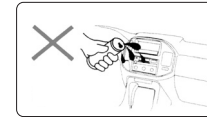
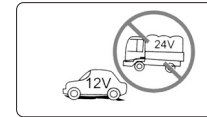

Warnings and Precautions

Precautions

- 1、 Never disassemble or adjust the unit without any professional guide. For details, please consult any professional car shop/ dealer for inquiry.
- 2、 If the front panel or the TFT monitor is squalid, please use a clean silicone cloth and neutral detergent to wipe off the spot. Using a rough cloth and non-neutral detergent such as alcohol for cleaning may result in scratching or decoloration to the applicant.
- 3、 If any abnormal behavior of the unit is found, please refer to trouble shooting guide of this manual. If no relevant information is found , please press the [RESET] key on the front panel to resume factory default.
- 4、 If you have parked the car in hot or cold weather for a long time, please wait until the temperature in the car becomes normal before operating the unit.
- 5、 Using in-car heater in low temperature environment may result in beads coagulate inside the unit, DO NOT use the unit in this situation, eject the disc and wipe off the bead on the disc. If the unit still doesn't work after a few hours, please contact with after-sales service center.
- 6、 No fierce impact to the LCD monitor when it is in open position for preventing the damage to any mechanisms inside.
- 7、 To prevent the damage to the screen, avoid touching it with sharp objects.
- 8、 The monitor employs auto motorizing mechanism, please don't push, pull, or swivel the monitor manually to prevent damage to any mechanisms inside.
- 9、 To provide a clear demonstration and an alternative for easy understanding to the operation of this unit, graphic illustrations are used. However, these illustrations are some different from the actual images displayed in the unit.
- 10、 During operation the unit, "⏸" is displayed if the particular operation is not available or illegal.
- 11、 Operate the unit correctly according to this manual to prevent. Unnecessary problem. The guarantee won't be valid if the problem is caused by inappropriate operation.

Electric Connection

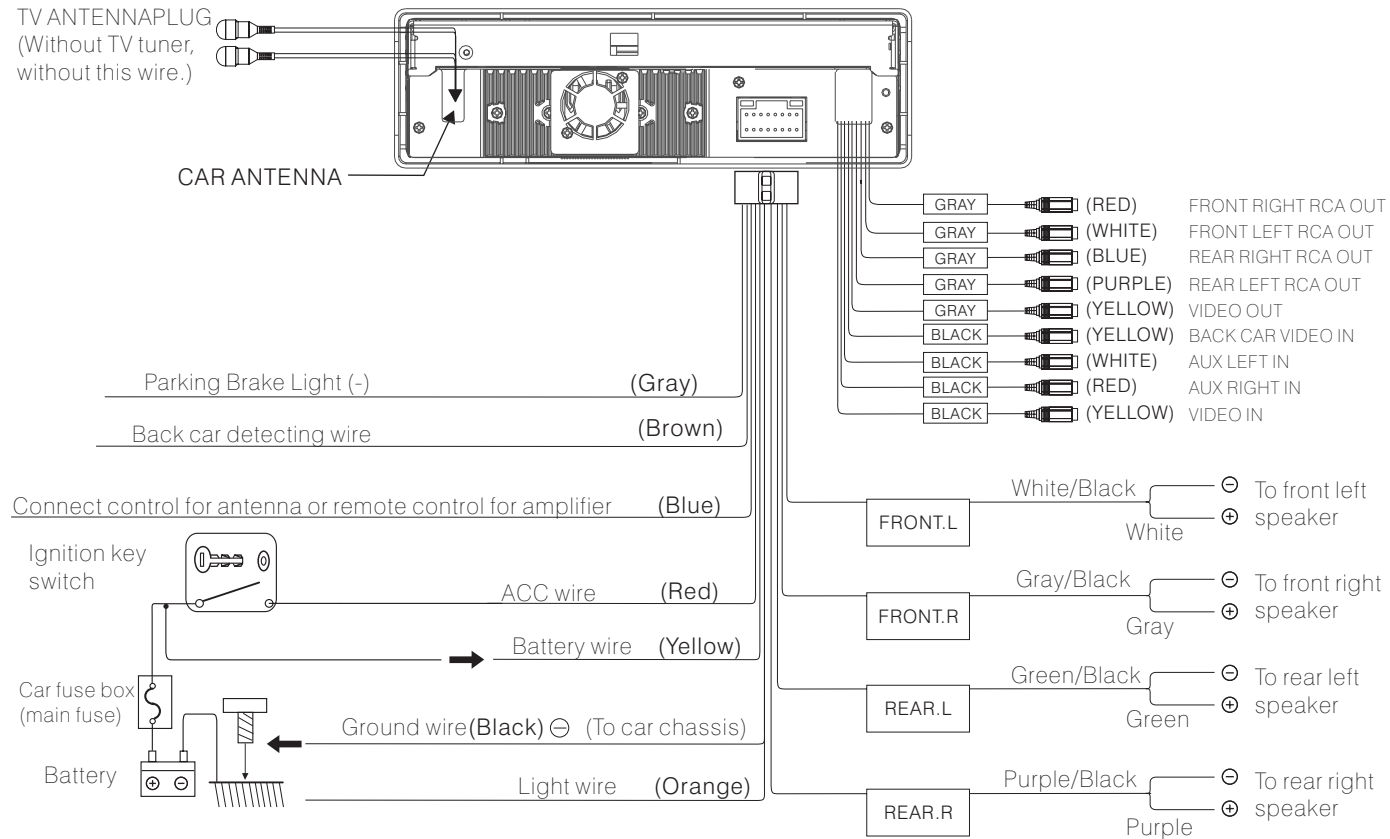

Installation

- Before installing the receiver permanently, fit it in the approximate place in your car, and connect the equipment according to the speakers and electrical connections. When your system is operated properly, (preferably with the car engine running), follow the instructions for permanent installation of your system.

INSTALL THE UNIT

- 1) Install half sleeve, can be with or without adapter. It will fit better with adapter.
- 2) Bend over some tabs to secure the half sleeve inside of dash.
- 3) Support strap to be strutted under dash, secure this strip to avoid skipping of disc.

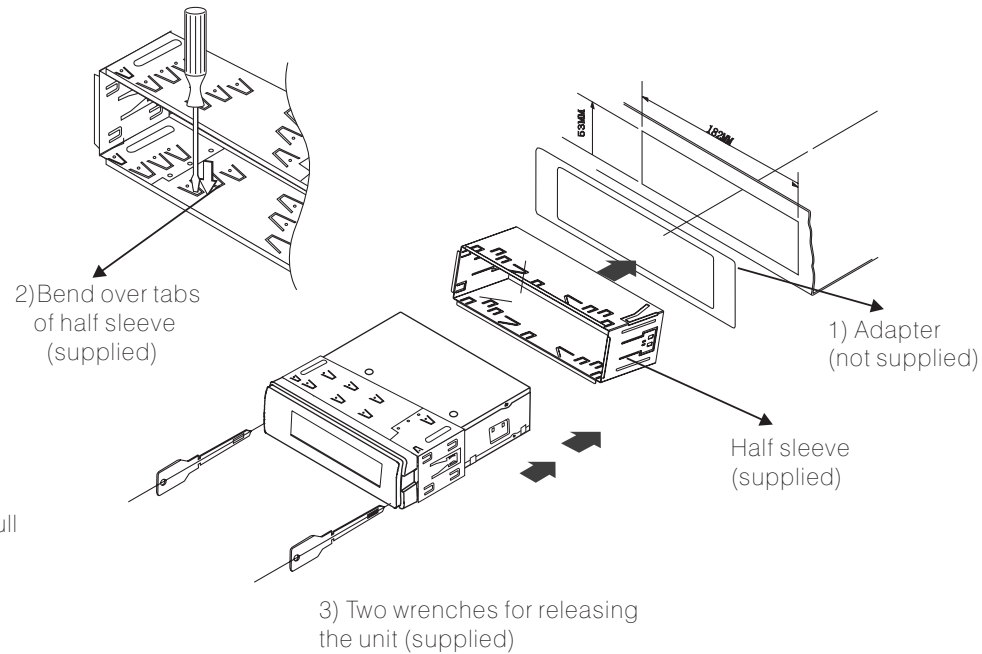

REMOVE THE UNIT

- Insert removal wrench into the small gap on the right side of the unit and pull the unit slightly out on the same side, then release the wrench. Repeat the same action for the left side. By now, you can remove the unit and unplug the wires connector.

General Features

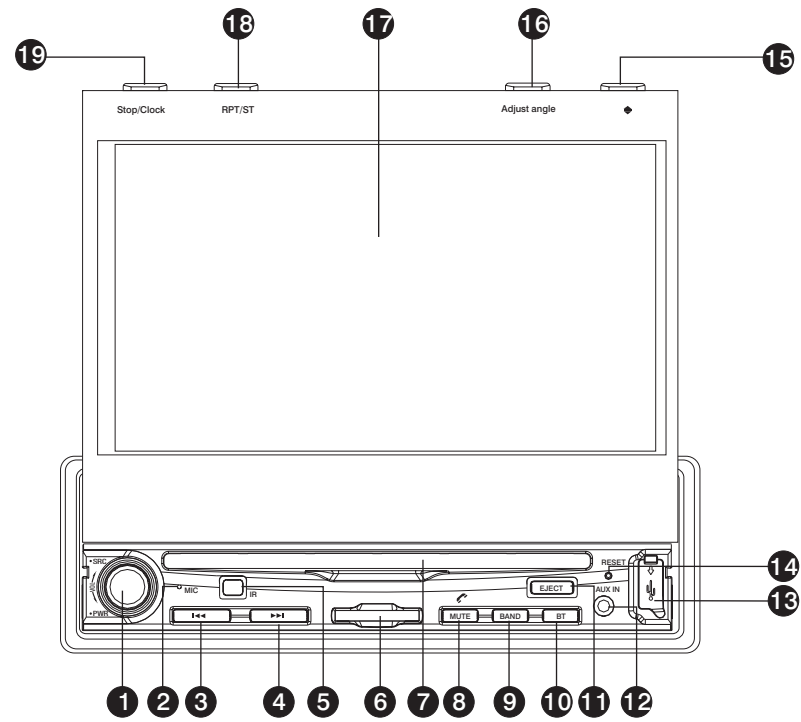

General Features

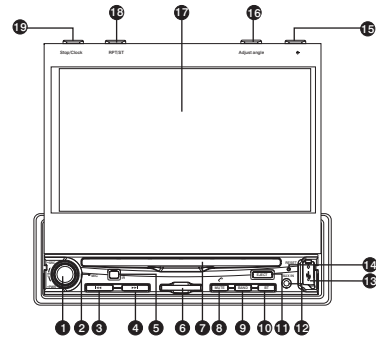

- 1 VOL/SRC/PWR Button: Rotate the VOL button to adjust the volume; press it to make confirmation./Play source switch.
- 2 MIC.
- 3 4 [REW]/[LAST] Button: Rewind, Last chapter/Forward, Next chapter.
- 5 Signal received window.
- 6 SD Slot.
- 7 To eject the DISC.
- 8 MUTE/[MUTE] Button: Mute/Answer.
- 9 BAND Button: Band switch/Radio mode is random play.
- 10 BT Button: Switch to BT function directly.
- 11 EJECT Button: To eject the DISC.
- 12 AUX IN
- 13 USB Port.
- 14 Reset Button.
- 15 [Display] Button: Display Open/Close.
- 16 Adjust angle Button: Display position Adjustment.
- 17 TFT-LCD screen.
- 18 ST/RPT Button: Sound track switch/Repeat.
- 19 CLOCK/STOP Button: Clock/Stop.

Remote Control

Loading and replacing the battery

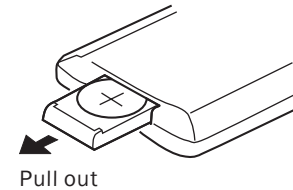

Notes of remote control using:

- 1) Aim the remote controller at the remote sensor on the unit.
- 2) Remove the battery from the remote control or insert a battery insulator if the battery has not been used for a month or longer.
- 3) DO NOT store the remote control under direct sunlight or in high temperature environment, or it may not function properly.
- 4) The battery can work for 6 months under normal condition. If the remote control can't work, please change the battery.
- 5) Use (button shaped) lithium battery (CR-2025) only.
- 6) DO NOT recharge, disassemble, heat or expose the battery in fire.
- 7) Insert the battery in proper direction according to the (+) and (-) poles.
- 8) Store the battery in a place where children cannot reach to avoid risk of accident.

Remote Control

■ Button and Function

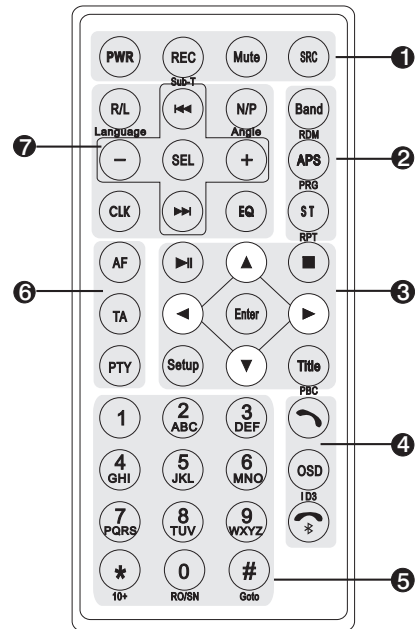

Note: This unit doesn't have RDS function, AF/TA/PTY neither.
This unit doesn't have bluetooth function, [Ring on]/[Ring off] neither.
If the unit hasn't some functions, some buttons won't be affected.

- 1** [PWR] Button: Power
[REC/Sub-T] Button: Transfer recording/Language switch
[MUTE] Button: Mute
[SRC] Button: Play source switch

- 2** [BAND/RDM] Button: Band switch/Play randomly
[APS/PRG] Button: Scan/Program
[ST/RPT] Button: Stereo switch/Repeat
- 3** [Play/Pause] Button: Play/Pause
[Stop] Button: Stop
[Setup] Button: Menu setting
[Title] Button: Title Menu
[ENTER] Button: Play/Confirm
[Up/Down/Left/Right] Button: Up/down/left/right button
- 4** [Ring on] Button: Ring on
[OSD/Id3] Button: Screen Display/ Select chapter
[Ring off] Button: Ring off
- 5** [0~9] Button: 0~9
[GOTO] Button: GOTO search
[RO/SN] Button: Radio scan
- 6** [AF] Button: Search stations automatically
[TA] Button: Traffic broadcast
[PTY] Button: Program style
- 7** [Next Chapter] Button: Forward/Next chapter
[Last Chapter] Button: Rewind/Last chapter
[Volume +/-] Button: Increase/reduce volume
[SEL] Button: System setting
[CLK] Button: Clock display
[EQ] Button: Sound effect
[N.P/ANGLE] Button: Video switch/Angel Adjustment
[R.L/LANGUAGE] Button: Left/right sound track switch dialogue language.

Play operation

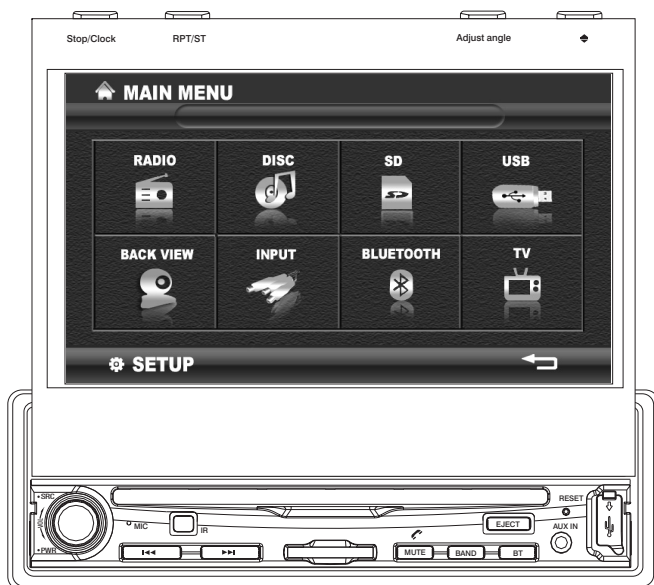

ON.OFF

- Press [PWR] button shortly will turn the unit on. Hold [PWR] button down will turn off the unit.

NOTE: When the power is on, the screen enters RADIO mode automatically; press [ESC] button to go back to the main menu; press [SRC] button shortly to switch to other modes.

Flex screen(◀▶)

Open screen: Press [▶] to open.

Close screen: Press [▶] to close.

Note:

- If the screen stop when out press [▶] to hide the screen, then press [▶] again the screen will out.
- When power off, the screen will hide.

Eject

EJECT: Press [▲] to eject the disc.

Note: About 10 seconds after the disc ejected, if not taken out, the disc will be absorbed in again.

Volume

Increasing Volume:

- Rotate the VOL button in counterclockwise direction.

Decreasing Volume:

- Rotate the VOL button in anticlockwise direction.

Stop/Clock

STOP:

- Press [STOP] button to stop when DVD playing.

CLOCK:

- Press [CLOCK] to switch between radio frequency and clock, when radio playing.

Play operation

Display position Adjustment

- For smooth adjustment, make sure that you return the lateral angle to the neutral position and then adjust the tilt angle.
- Avoid physical shock on the display.

Tilt angle

- Press [ADJ] button, it can adjust the screen angle gradually. The unit has 4 grades for adjustment, and each time you press the button, it can move one grade down along indication; it can resume up along indication.
- When you turn on the unit again, the angle will be the same as the last angle that you set.

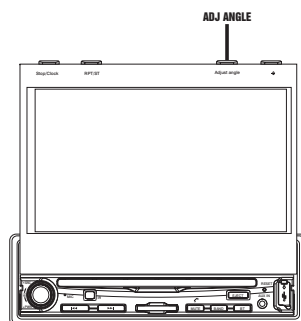
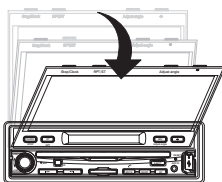

CAUTION

- Do not place any object on the display forcefully, or subject it to undue force.
- Do not move the display forcibly.
- The monitor's movable range may be limited by the type of car, a position where the display is mounted, etc.

MUTE/

MUTE: Short press this button to mute the sound, short press “MUTE” button again or press any other button to resume the normal listening.

Channel seek: In BT mode, when call coming, press this button can answer.

Setup Operation

MENU

ENTER MENU: Press [MENU] button, then touch setting button, it will show in screen follows:

Video mode:

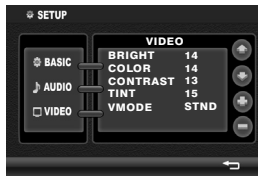

Menu operation

Touch [➔]/[➜] to choose menu.
 Touch [➕]/[➖] to adjust parameter.
 Touch [⏪] to back main menu.

Audio mode:

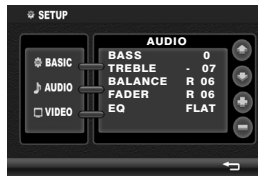

Menu operation

Touch [➔]/[➜] to choose menu.
 Touch [➕]/[➖] to adjust parameter.
 Touch [⏪] to back main menu.

BASIC mode:

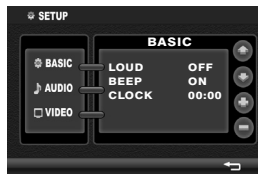

Menu operation

Touch [➔]/[➜] to choose menu.
 Touch [➕]/[➖] to adjust parameter.
 Touch [⏪] to back main menu.

Video setup

- Bright, Color, Contrast, Tint

- Vmode



Audio setup

- Audio setup: Bass, Treble, Balance, Fader setup between 0~14.

- EQ setting:



System setup

- Loud: ON and OFF
- Beep: ON and OFF
- Time Adjust: press [➔] or [➜] button to select hour/minute then press [➕] or [➖] button to setup.

Radio Operation

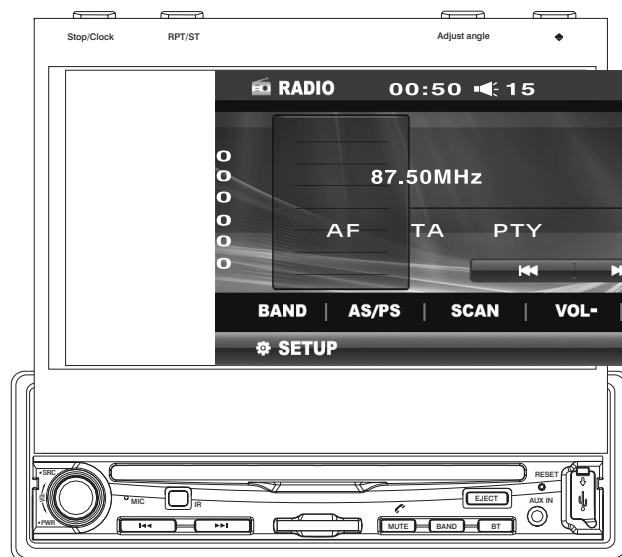

Note: If the unit doesn't have RDS function, the touch-screen won't show "AF, TA and PTY".

Band

- Press [BAND] button to transfer band.



Select station

Press [AS/PS] button

- Seek Tune:
In radio playing mode, holding down the [AS/PS] icon will seek and store strong frequency stations automatically.
Note: FM band can store 18 stations; AM band can store 12 stations.

Browse station

Press [SCAN] button

- Press [SCAN] button to scan the existing station.

Band Tune

Manually Tune

- Press [▶▶] button: adjust to higher frequency. (such as 87.5, 87.55...)
- Press [◀◀] button: adjust to lower frequency (such as 105.5, 105.0...)

Automatically Tune

- Holding down the [▶▶] button: search higher frequency station, and will stop when meeting one.
- Holding down the [◀◀] button: search lower frequency station, and will stop when meeting one.

Radio Operation

AF(Alternative Frequency)

- Press AF and then press [▶▶], the machine will scan signal get the best frequency of the local radio station. If meet a stronger signal of the same program. letter “TP” will appear on LCD, and unit will automatically choose the stronger signal sought. Before auto scan the radio station, please turn off “AF” firstly.

Only remote control (→ page8)

TA(Traffic announcement)

- Press TA, the unit will prior to seek the traffic information. If the machine receives the traffic information, it will choose this signal and quit other radio signal or CD program. If press TA again, other program will recover and the traffic information program will quit.

Only remote control (→ page8)

PTY(Program type)

- Press PTY, the unit will begin to receive program as news, current affairs ,music, etc. The unit will seek the program automatically and will quit CD player if it gets the right program. If press PTY again, PTY function will quit and other program will play as before.

Among AF, TA and PTY, TA has the absolute priority to be chosen.

Only remote control (→ page8)

Note: If the unit is without RDS function, please skip this page.

Sound Operation

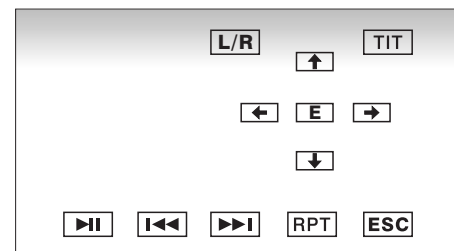
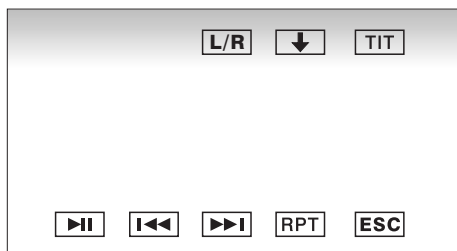

Play/pause

- In play mode, press [▶||] button to switch to play or pause mode.

⏮ ⏭

- **Select chapter or section:** In the DVD mode, press [⏮] to choose last chapter, press [⏭] to choose next.
- **Forward:** Hold [⏭] button down;
- **Rewind:** Hold [⏮] button down.

RPT

RPT: In the play mode, press [RPT] button then can transit among the following status.



↓

Five direction button: In play mode, you can touch [↓] [↑] icon to choose music, touch [E] to play music.

TIT

Title: In play mode, press [TIT] on the screen or remote control to back to the title menu, and re-select the items needed.

L/R

R/L: In VCD/CD/DVD mode, press [R/L] on the screen or remote control to switch among mono L, mono R or stereo.

SD/USB Operation

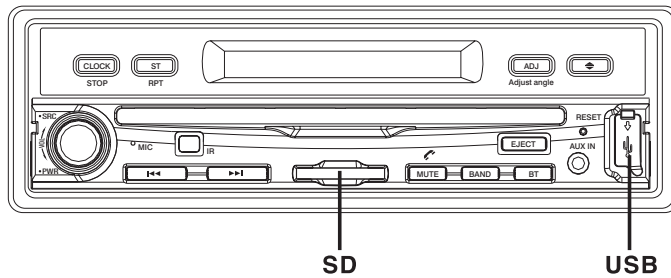

USB/SD play operation

PLAY/PAUSE:

- Press [▶||] button to play or pause.

◀▶ Select:

- Under USB or SD play, press [◀▶] can select tracks.

REPEAT

- Press [ST/RPT] button first to repeat the playing track



BAND:

- Press [BAND] button to play the disc randomly.

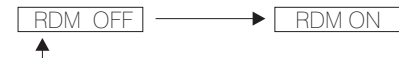

USB/SD mode

USB/SD mode

- Inset USB/SD, the play will to the USB/SD playing mode automatically.

Bluetooth

The Bluetooth is wireless mode of transmission in short distance. Through Bluetooth function, the DVD unit establishes connection with Bluetooth handset. And then, these units can realize mutually controlling and file transferring.

Choose the Bluetooth Mode

Method :

A: Press the [SOURCE] button, to return to main menu..

B: Exhales the main menu, choose the Bluetooth to enter the Bluetooth mode. (NO.1)

Working mode of Bluetooth

Bluetooth has the following functions:

A: Pairing
Make DVD Bluetooth function as handset's facility through pairing.

B: Connecting
After connecting with the handset, you can operate the mobile phone through DVD unit (such as H,F, call, call record etc.)

Pairing

Phone set pairing step as follows:

A: Turn on Bluetooth, then touch On/Off icon to turn on this function. (NO.2)

B: Turn on handset's Bluetooth function .

C: When the mobile phone set finds the signal, input pairing number. Initial Pairing Code No. " 0000"

D: After pairing, TFT screen shows pairing succeed and quit the pairing.

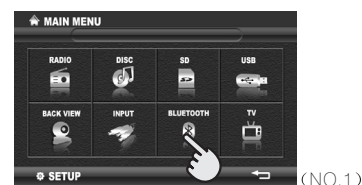

Bluetooth

Mobile phone

After connected, you can make phone call through, touch screen or phone record.

A: Making mobile phone call
After making phone call, the [📞] will shining.

B: Making touch screen call
Input the numbers on the screen, press [←] icon can correct the numbers;
Press [📞] icon to answer phone call;
Press [📞] icon to cancel or hang up.



Answering

Answering functions as follows:

A: After connected, the unit can use the telephone function.
B: When there is a phone call, the Bluetooth will switch to phone function and show the calling number automatically.

C: Touch Transfer icon can switch to phone answer mode.
Touch it again can return to Bluetooth function of the unit.

Remarks: Some mobilephone can't support this switch function.

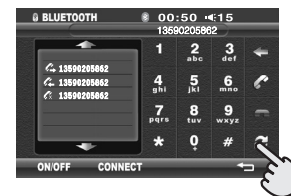

Hang up

You can press the [📞] button to hang up.



Note: If the unit does not have this function, pls skip it.
Some models of mobile phones are not supported by the Bluetooth module of this unit.

TV Operation

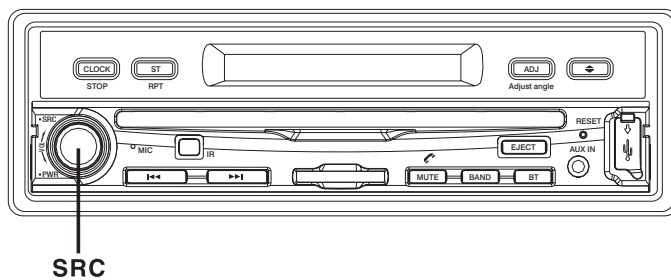

Without touch function, without these icons.

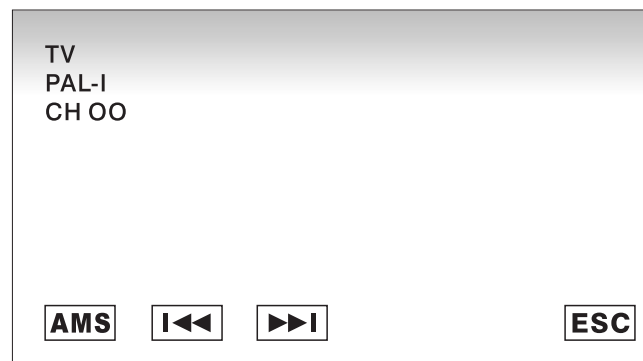

TV operation

You need install TV antenna, when receive program.

TV mode:

- Press [SRC] to enter main menu, then press TV icon on TFT screen to enter.

Channel search:

- Press [APS] or press [AMS] to search and store TV station automatically.

Direct Channel Selection: (Only for remote control)

- Enter a channel number by pressing [0] to [9].

Note: If the unit does not have this function, pls skip this page.

Accessories

External view

..... Number of items



.....1

External view

..... Number of items



.....1



.....2



The use of any accessories except of those provided might result in damage to the unit .Make sure only to use the accessories shipped with the unit ,as shown above.

Troubleshooting

What appears to be trouble is not always serious. Please check the following points before calling a service center.

Familiar characters and their meanings

Characters	Causes	Remedies
NO Disc	Disc is too dirty.	Clean the disc or change the disc.
	Disc is inserted upside down.	Insert the disc correctly.
	No disc in the unit.	Insert a disc.
Bad Disc	Disc is extreme dirty.	Clean the disc or change the disc.
	Disc is inserted upside down.	Insert the disc correctly.
Unkown Disc	The disc is not compatible with the unit.	Clean the disc.
Region Error	The disc's region code is not the same as the unit's.	Clean the disc.
Disc inject dead	Disc transparence fault press disc button long time exit.	Then change the angle and inject again or change another disc.

Troubleshooting

General problems

Symptoms	Causes	Remedies
The unit cannot be powered on.	The fuse of the unit has been broken.	Install a new fuse with correct rating.
	The fuse of car battery has been broken.	Install a new fuse with correct rating.
	False operations and etc.	Reset the unit.
Remote controller does not work.	Battery has been exhausted.	Change the battery.
	Battery is not installed correctly.	Install the battery correctly.
No sound comes out or it's hard to hear.	Audio output connection is not correct.	Correct the connection according to(Electrical Connections Overall Diagram).
	The volume level is set to the minimum level.	Adjust the volume to the optimum level.
	The speakers have been damaged.	Check the speakers.
	The audio channel outputs are not balanced.	Adjust the balance of audio channel outputs. Please refer to (Audio control).
	The speaker cord is contacted with the bodywork.	Use insulating cord for connection.
Poor sound quality or sound distortion.	Piratic disc is used.	Use original copy disc.
	The speakers power rating does not fit into the unit output power.	Change the speakers.
	The speakers are connected incorrectly.,	Correct the connection according to(Electrical Connections Overall Diagram).
	The speaker cord is contacted with the bodywork.	Use insulating cord for connection.
User preset information is lost when ACC is off.	ACC and BATT are connected incorrectly.	Correct the connection according to(Electrical Connections Overall Diagram).

Troubleshooting

TFT Monitor

Symptoms	Causes	Remedies
No image appears on the monitor and warning information is shown at all times.	Incorrect connection of Breaking wire.	Correct the connection according to (Electrical Connections Overall Diagram).
Abnormal display like as pulsatile stripes on the image and on.	The color system of DVD disc is not suited with the monitor.	Adjust the color system of the DVD disc or the monitor.
	The actual color system is not the same as the marked color system on the label for some piratic discs.	Use original copy disc.
	The video cord is broken.	Change the video cord.
	The video cord is not connected correctly.	Connect the video cord correctly.
Characters are abnormal.	False operations.	Turn off the power and then turn on the power again, or change to other playing source and then go back.

Troubleshooting

Radio Tuner

Symptoms	Causes	Remedies
It's hard to receive stations.	Auto antenna is not extended completely.	Correct the connection according to (Electrical Connections Overall Diagram).
	Auto antenna is not connected with the unit firmly.	Correct the connection according to (Electrical Connections Overall Diagram).
	LOCAL function is on.	Close the LOCAL function.

Mp3 playback

Symptoms	Causes	Remedies
Disc cannot be played back.	Disc is scratched.	Change the disc.
	Disc is too dirty or wet.	Clean the disc.
	The pickup is dirty.	Clean the pickup with cleaning disc.
	Disc is inserted upside down.	Insert the disc correctly.
Interruption occurred during playback.	Disc is scratched.	Change the disc.
	Disc is too dirty or wet.	Clean the disc.
	Some contents are damaged.	Change the disc.
	Disc is not recorded correctly.	Record the disc again.
MP3's name cannot be displayed correctly.	The name of Mp3 is not regular.	Use the regular characters.

Troubleshooting

DVD player

Symptoms	Causes	Remedies
Disc cannot be inserted.	There is a disc in the unit already.	Eject the disc then insert another one.
Disc cannot be played back.	Disc is scratched.	Change the disc.
	Disc is too dirty or wet.	Clean the disc.
	The pickup is dirty.	Clean the pickup with cleaning disc.
	Disc is not compatible with the unit.	Change the disc.
	Parental lock class is too high.	Change the parental lock class.
	Disc memory less than 120M.	Choose the disc of memory more than 120M.
	Disc is inserted up side down.	Insert the disc correctly.
	The disc 's region code is not the same as the unit 's.	Change the disc.
Subtitle cannot be shown.	There is no subtitle file in the disc.	Change another disc containing subtitle files.
Audio language/subtitle cannot be changed.	There is only one audio language/subtitle in the disc.	Change another disc containing multi-language audio or subtitle.
View angle cannot be changed.	There is just one view angle in the disc.	Change another disc containing multi-angle.
	Multi-angle view is not available for the segment playing back now.	Select another segment to play back.
Image distortion.	The disc is protected by the copyright.	The unit is compatible with copy system; hence some discs contained the information of copying prohibited cannot be played back.
PBC is invalid when playing back VCD.	The disc does not support PBC.	Change another disc with PBC function.
Repeat playback or GOTO search is invalid when playing back VCD.	PBC is on.	Close PBC function.

1 Year Limited Manufacturer Warranty -

XO Vision warrants to the original retail purchaser of this product that should this product have any defect, under normal conditions, such defect(s) will be repaired or replaced with new or reconditioned product (at the Company's option) without charge for parts and repair labor.

If said product is out of stock, XO Vision has the option to replace it with a similar product or issue a refund at our discretion. This warranty only covers manufacturer defects and must be returned to company in original condition. Proof of Purchase is required. This Warranty does not cover the costs incurred for installation, removal, product damages (i.e. discs, tapes, etc.) or reinstallation of the product.

This warranty is void if company deems the unit to have been damaged through modification, improper installation, negligence, misuse, or tampering with the Serial number and/or bar code of the unit. This warranty is a limited warranty for repair/replacement of product if it falls under the above conditions. XO Vision is never responsible for more than the purchase price of the product.

XO Vision encourages customers to contact the retailer first and only then contact XO Vision for warranty support.

Customer is responsible for shipping the product to us; we cover shipping back to the customer.

If you are having trouble with your unit, please email us at: CustomerService@XOVision.com

In your email, please include the model number, date and place of purchase and the problem. Thank you for purchasing XO Vision.

OWNER'S MANUAL

Before installation and operating the unit please read
this manual thoroughly and retain
it for future reference