

ZANUSSI

TUMBLE DRYER TC 481 W

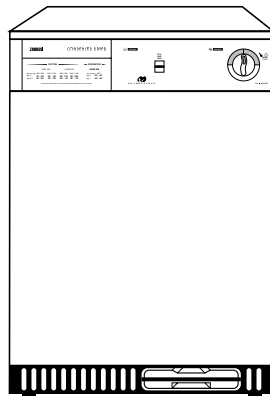



Important Safety Information

It is most important that this instruction book should be retained with the appliance for future reference. Should the appliance be sold or transferred to another owner, or should you move house and leave the appliance, always ensure that the book is supplied with the appliance in order that the new owner can get to know the functioning of the appliance and the relevant warnings.

These warnings have been provided in the interest of safety. You **MUST** read them carefully before installing or using the appliance.

Installation

- This appliance is heavy. Care should be taken when moving it.
- It is dangerous to alter the specifications or attempt to modify this product in any way.
- Any electrical work required to install this appliance should be carried out by a qualified electrician or competent person.
- Care must be taken to ensure that the appliance does not stand on the electrical supply cable.
- If the machine is situated on a carpeted floor, please adjust the feet in order to allow air to circulate freely.
- If the tumble dryer is placed on top of a washing machine, it is compulsory to use the stacking kit (optional accessory).

Child Safety

- This appliance is designed to be operated by adults. Children should not be allowed to tamper with the controls or play with the product.
- Pets and children have been known to climb into tumble dryers. Please check your drum before use.
- Keep all packaging well away for children.

Use

- Do not overload the appliance (see programme chart).
- Clothes which are dripping wet should not be placed in the dryer.
- As some bulky items such as duvets and eiderdowns should be dried in large commercial machines because of their bulk, check with the manufacturer of the item if it is suitable for drying in a domestic machine, even if the dry weight of the item is within the limit advised.
- Do not dry canvas shoes or sports shoes, as they could get stuck between the door and the drum, thus blocking this latter.
- Please make sure that no gas lighters have accidentally been left in pockets of garments to be loaded into appliance.
- **Danger of explosion:** Never tumble dry items that have been in contact with inflammable solvents (petrol, methylated spirits, dry cleaning fluid and the like). As these substance are volatile, they could cause an explosion. Tumble dry only items washed with water.
- In order to avoid danger of fires caused by excessive drying, do not use appliance to dry the following items:
 - Cushions, quilts and the like (these items accumulate heat).
 - Items containing rubber foam or materials similar to rubber foam.
 - Leave the door slightly ajar when the appliance is not being used. This will allow the seal to be preserved.
 - Clean fluff filter after using tumble dryer. To prevent fire risks, do not use the appliance if the fluff filter is damaged or without filter.
- Under no circumstances should you attempt to repair the machine yourself. Repairs carried out by inexperienced persons may cause injury or serious malfunctioning. Contact your local Zanussi Service Centre. Always insist on genuine Zanussi spare parts.

Contents

For the User

Important Safety Information	2
■ Installation	2
■ Child Safety	2
■ Use	2
Your New Tumble Dryer	4
Description of the Appliance	4
The Control Panel	5
■ Water full indicator light	5
■ Mains-on light	5
■ Time selector dial/ON-OFF switch	5
Programme Chart	6
Operating Sequence	7
■ Load the laundry	7
■ Select the drying time	7
■ When drying is completed	7
Hints & Tips on Drying	8
Maintenance and Cleaning	9
■ External cleaning	9
■ Cleaning fluff filter	9
■ Cleaning the condenser unit	9
■ Emptying the water reservoir	9
Something Not Working	10
Service and Spare Parts	10
Customer Care	10
Zanussi Service Force	11-12
Guarantee Conditions	13

For the Installer

Installation Instructions	14
Technical Specifications	14
■ Positioning	15
■ Stacking kit (optional accessory)	15
■ Door reversal	16
■ Electrical connection	17

Guide to use the Instruction Book

The following symbols will be found in the text to guide you throughout the instructions:



Safety instructions



Hints and tips



Environmental information

Your New Tumble Dryer

This tumble dryer will give your wash that soft, relaxed feel whatever the weather.

Extremely high quality standards both during development and manufacturing guarantee a long service life for your appliance.

Maximum economy in the operation of your dryer is achieved through very frugal electricity consumption and short drying times.

Energy saving tips

To save energy we recommend that you follow these hints:

- Try to load the maximum capacity of the machine as small loads are **uneconomical**.
- Always load well spun laundry. The higher the spin speed, the lower the electricity consumption and the shorter the drying times.
- Do not over-dry laundry, this avoids creasing and saves energy.
- Clean the filter regularly to avoid excessive drying times and high electricity consumption.
- Ventilate the room well. The room temperature should not exceed +35°C during drying.

In the interest of the environment

- Materials marked with the symbol  are recyclable.
- Check with your local Council or Environmental Health Office to see if there are facilities in your area for re-cycling this appliance.
- When the appliance is to be scrapped, cut off the power supply cable and make the door closing device unusable to prevent young children from being trapped inside.
- Help to keep your country tidy - use authorised disposal sites for your old appliance.

How do we help to protect the environment? We use recycled paper!

Description of the Appliance

- 1 Worktop
- 2 Reservoir Full Indicator Light
- 3 Door Open Button
- 4 Mains-On Light
- 5 Time Selector Dial-ON/OFF switch
- 6 Programme Chart
- 7 Fluff Filter
- 8 Door Catch
- 9 Rating Plate
- 10 Ventilation Grille
- 11 Water Reservoir
- 12 Condenser Unit
- 13 Adjustable Feet

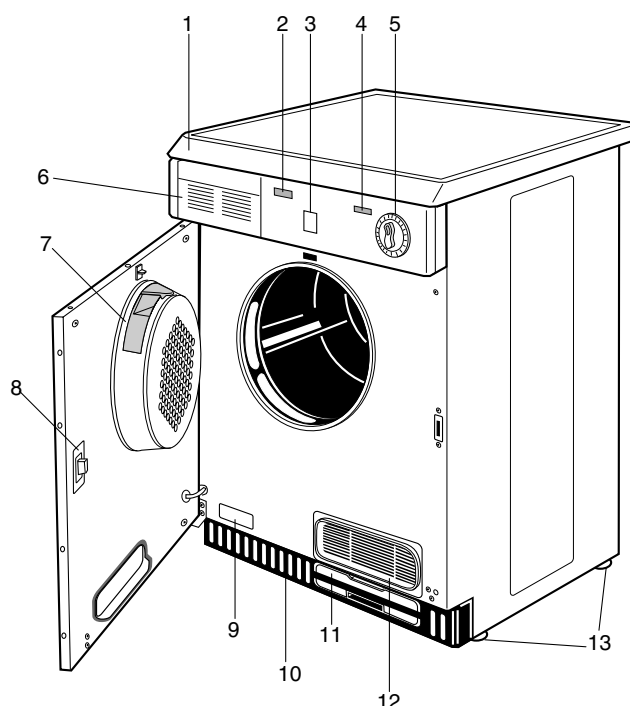

The Control Panel

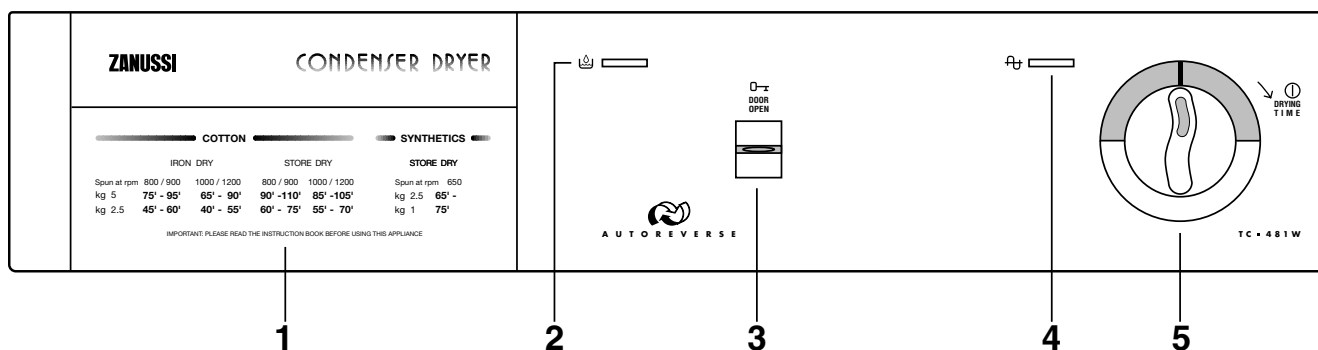

1 Programme Chart

This will help you to select the correct time for drying.

2 Water Full Indicator Light (red)

This light illuminates when the reservoir is full or improperly fitted.

The programme will be interrupted.

3 Door Open Button

Depress this button to open the door.

The door of the machine can be opened at any time during the programme if you want to feel the dryness of the fabrics.

4 Mains-On Light (green)

This light indicates operating status.

5 Time Selector Dial-On/Off Switch

Turn the dial clockwise (to the right) to select the time for drying (see Chart page 6). At the same time the machine is switched on and the programme starts.

This dryer has two drying cycles of up to 120 and 80 minutes, giving a high or low heat temperature according to the type of fabric.

When selecting the drying time you should remember that it includes a 12 minute cooling phase (position  on the dial).

This phase should not be shortened, stopped or avoided, as this could cause skin burns or damages to the laundry.

Programme Chart

Cotton and linen

Selector dial up to 120 minutes (high temperature section)

Type of laundry:	Degree of drying	Amount of laundry in kg	Drying time in minutes for laundry spun at	
			800/900 rpm	1000/1200 rpm
Cotton Towelling Shirts Sheets	Store dry (wardrobe dry)	5	90-110	85-105
		2.5	60-75	55-70
Hand towels Tablecloths Table napkins	Iron dry (not completely dry; suitable for ironing)	5	75-95	65-90
		2.5	45-60	40-55

Synthetics

Selector dial up to 80 minutes (low temperature section)

Type of laundry:	Degree of drying	Amount of laundry in kg	Drying time in minutes for laundry spun at a minimum speed of 650 rpm
Synthetics or mixed fabrics which do not require ironing.	Store dry	2.5	50-60
		1	30-40
Synthetics or mixed fabrics which have to be ironed. (Please see labels on items)	Iron dry	2.5	40-50
		1	20-30

ATTENTION! Please follow the instructions on labels when drying mixed fabrics.

Operating Sequence

Before using your tumble dryer for the first time, we recommend to place a few damp cloths inside the appliance and dry for approximately 20 minutes. There may be dust inside a brand new tumble dryer.

1. Load the laundry

Open the door by pressing the relevant button. Load the items one at a time, shaking them out loosely and close the door. Please check the laundry does not get caught between the door and filter.

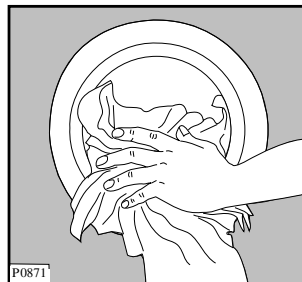

2. Select the drying time

Turn the selector dial clockwise to the desired time (in the high or low temperature section, according to the fabric). The mains-on light illuminates and the programme starts.

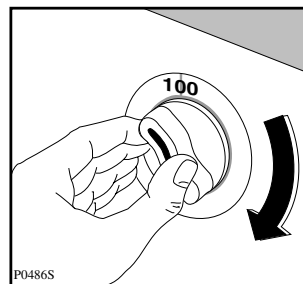

3. When drying is completed

The machine stops automatically and the mains-on light goes out.





Open the door and take out the laundry.

Clean the filter after every drying programme. A clean filter ensures correct functioning of the appliance.

Hints & Tips on Drying

Before placing articles of laundry in your tumble dryer, check the care labels to ensure they are recommended for tumble drying.

Care Labels you may find on your laundry

-  normal drying (high temperature)
-  delicate drying (low temperature)
-  do not tumble dry
-  may be tumble dried

 **Do not overload the appliance.**

Here is a list of the approximate weight of some common laundry items.

Sheet	700 to 1000 g
Pillowcase	100 to 200 g
Tablecloth	400 to 500 g
Table Napkin	50 to 100 g
Kitchen Towel	70 to 120 g
Linen Hand Towel	100 to 150 g
Hand Towel	150 to 250 g
Bath Towel	700 to 1000 g
Bathrobe	1000 to 1500 g
Shirt	200 to 300 g
Apron	150 to 200 g

- Always load well spun laundry. The higher the spin speed the lower the electricity consumption and the shorter the drying time.
- DO NOT load dripping wet laundry into the dryer. Roll the article in a towel or spin to remove excess water.
- Close poppers and zips and fasten any buttons.
- Sort the laundry. Separate synthetics from cotton/linens, and dry separately.
- Remove the laundry immediately after the programme has finished.
- Use a fabric conditioning sheet to reduce static. We recommend the sheet is pinned to an article of laundry (using a safety pin).
- Mix the load i.e. large and small articles.
- When drying large items such as sheets, we recommend you periodically stop the dryer to redistribute the load.

DO NOT use the tumble dryer to dry the following:

- Articles contaminated with inflammable substances e.g. petrol, cleaning solvents, cooking oil, fats or hair lacquer.
- Woollen and synthetic/wool mixtures unless the item is labelled as suitable for tumble drying.
- Very delicate articles such as silk.
- Very large and bulky items such as duvets or sleeping bags.

Maintenance and Cleaning

You must **disconnect** the appliance from the electricity supply, before you can carry out any cleaning or maintenance work.

External cleaning

Use only soap and water and then dry thoroughly. From time to time, apply a little wax furniture cream with a soft cloth.

Important: do not use methylated spirit, diluents or similar products.

Cleaning the filter

The tumble dryer cannot operate efficiently with a clogged filter. The filter collects all the fluff which forms during drying and it is therefore essential to remove and clean this filter after each drying programme.

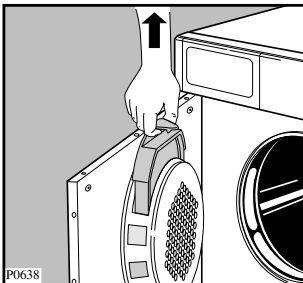

You should not be alarmed by the amount of fluff which collects on the filter; this is due to normal wearing of the fabrics dried and not to incorrect operation of your machine. Rubbing of the fibres during normal wear and washing forms fluff. If laundry is dried on a line, this fluff simply flies away, whereas inside the tumble dryer it collects together and swells considerably as a result of the drying action.

Cleaning the condenser unit

Clean the air condenser periodically, 3 or 4 times a year depending on how frequently the dryer is used. Pull out the condenser, holding it at the top, and remove all fluff. Clean it with a brush and rinse it under the shower if necessary.

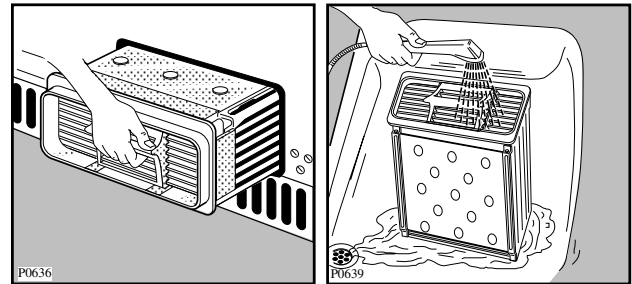

Also clean the outside, removing all fluff. Clean the rubber seal round the porthole door and the seal of the condenser in the inner door with a damp cloth.

Emptying the water reservoir

Water extracted from the laundry condenses inside the machine and is collected in a reservoir. The reservoir must be emptied after each drying cycle to ensure efficient operation when the machine is next used.

If this is not done a safety device trips: pilot light  on the control panel comes on and the programme stops, leaving the laundry damp.

The reservoir can be emptied even in the middle of a programme.

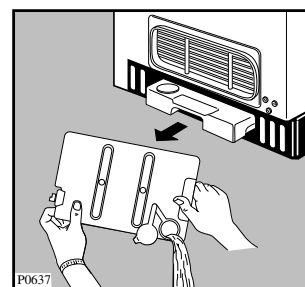

The reservoir must be re-inserted correctly.

Handy tip: The condensed water may be used in a steam iron or to top up a battery, etc. In this case it must be filtered (e.g. through a coffee filter).

Something Not Working

Certain problems are due to lack of simple maintenance or oversights, which can be solved easily without calling out an engineer. Before contacting your local Service Centre, please carry out the checks listed below.

IMPORTANT: if you call out an engineer to a fault listed below, or to repair a fault caused by incorrect use or installation, a charge will be made even if the appliance is under guarantee.

Symptom	Possible causes
The tumble dryer does not start	<ul style="list-style-type: none"> ■ The door has not been closed. ■ The plug is not properly inserted in the power socket. ■ There is no current at the socket ■ The main fuse or the fuse in the plug has blown. ■ A drying time has not been selected. ■ The water reservoir is full or not properly inserted (the pilot light  is on).
Drying takes too long or laundry is not dry enough.	<ul style="list-style-type: none"> ■ The laundry has not been spun properly. ■ The filter and/or air condenser are clogged up. ■ The room temperature is too high. ■ The selected time or section was not suitable for the laundry ■ There is too much laundry inside the appliance. ■ The dryer is not correctly installed.

Service & Spare Parts

In the event of your appliance requiring service, or if you wish to purchase spare parts, please contact your local Zanussi Service Force Centre by telephoning:

0870 5 929929

Your telephone call will be automatically routed to the Service Force Centre covering your post code area.

The addresses are listed on the following pages. Before calling out an engineer, please ensure you have read the details under the heading "Something Not Working".

When you contact the Service Force Centre you will need to give the following details:

1. Your name, address and post code
2. Your telephone number
3. Clear and concise details of fault
4. The model and serial number of the appliance (found on the rating plate - see picture on page 4).
5. The purchase date

Customer Care

For general enquiries concerning your Zanussi appliance or for further information on Zanussi products, please contact our Customer Care Department by letter or telephone as follows:

Customer Care Department

Zanussi

55-77 High Street

Slough

Berkshire

SL1 1DZ

Tel 08705 727727*

or visit our website at www.zanussi.co.uk

* calls to this number may be recorded for training purposes.

To contact your local Zanussi Service Force Centre telephone **08705 929 929**

CHANNEL ISLANDS		ORKNEY (M65) Corsie Domestics 7 King Street Kirkwall Orkney KW15	NORTH EAST	
GUERNSEY	Guernsey Electricity PO Box 4 Vale, Guernsey Channel Islands	PERTH Hydro Electrical Inveralmond House Ruthvenfield Road Perth PH1 3AQ	GATESHEAD (M39)	Unit 356a Dukesway Court Dukesway Team Valley Gateshead NE11 0BH
JERSEY	Jersey Electricity Company PO Box 45 Queens Road St Helier Jersey Channel Islands JE4 8NY	PERTH (OWN SALES) Graham Begg Unit 4 Airport Ind Estate Wick KW1 4QS	GRIMSBY (M42)	15 Hainton Avenue Grimsby South Humberside DN32 9AS
SCOTLAND		SHETLAND (OWN SALES) Tait Electronic Systems Ltd Holmsgarth Road Lerwick Shetland ZE1 0PW	HULL (M41)	Unit 1 Boulevard Industrial Estate Hull HU3 4AY
ABERDEEN (M05)	54 Claremont Street Aberdeen AB10 6RA	SHETLAND (OWN SALES) Bolts Shetland Ltd. 26 North Road Lerwick Shetland ZE1 0PE	LEEDS (M37)	64-66 Cross Gates Road Leeds LS15 7NN
AUCHTERMUCHY (M03)	33a Burnside Auchtermuchy Fife KY14 7AJ	WHALSAY (OWN SALES) Leask Electrical Harisdale Symbister, Whalsay Shetland ZE2 9AA	NEWTON AYCLIFFE (M45)	Unit 16 Gurney Way Aycliffe Industrial Estate Newton Aycliffe DL5 6UJ
BLANTYRE (M07)	Unit 5 Block 2 Auchenraith Ind. Estate Rosendale Way Blantyre G72 0NJ	NORTHERN IRELAND		
DUMFRIES (M01)	93 Irish Street Dumfries Scotland DG1 2 PQ	BELFAST (M27) Owenmore House Kilwee Business Park Upper Dunmury Lane Belfast BT17 0HD	NORTH WEST	
DUNOON (M67)	Brair Hill 7 Hill Street Dunoon Argyll PA23 7AL	WALES		
GLASGOW (M04)	20 Cunningham Road Clyde Estate Rutherglen Glasgow G73 1PP	CARDIFF (M28) Guardian Industrial Estate Clydesmuir Road Tremorfa Cardiff CF2 2QS	CARLISLE (M10)	Unit 7 James Street Workshops James Street Carlisle Cumbria CA2 5AH
INVERNESS (M06)	Unit 3B Smithton Ind. Estate Smithton Inverness IV1 AJ	CLYWD (M14) Unit 6-7 Coed – Parc Abergele Road Rhuddlan Clwyd Wales LL18 5UG	ISLE OF MAN (M64)	South Quay Ind. Estate Douglas Isle of Man IM1 5AT
ISLE OF ARRAN (OWN SALES)	Arran Domestics Unit 4 The Douglas Centre Brodict Isle of Arran KA27 8AJ	DYFED (M77) Maes Y Coed High Mead Llanybydder Carmarthenshire SA40 9UL	LIVERPOOL (M15)	Unit 1 Honeys Green Precinct Honeys Green Lane Liverpool L12 9JH
ISLE OF BARRA (OWN SALES)	J Zerfah 244 Bruernish Isle of Barra Western Islands HS9 5QY	HVERFORDWEST (M75) Cromlech Lodge Ambleston Haverfordwest Pembrokeshire SA62 5DS	MANCHESTER (M09)	Unit B Central Industrial Estate St Marks Street Bolton BL3 6NR
ISLES OF BUTE	Walker Engineering Glenmhor Upper Serpentine Road Rothesay Isle of Bute PA20 9EH	OSWESTRY (M17) Plas Ffynnon Warehouse Middleton Road Oswestry SY11 2PP	PRESTON (M13)	Unit 250 Dawson Place Walton Summit Bamber Bridge Preston Lancashire PR5 8AL
ISLE OF LEWIS	ND Macleod 16 James Street Stornoway Isle of Lewis PA87 2QW	STOCKPORT (M16) Unit 20 Haigh Park Haigh Avenue Stockport SK4 1QR		
KELSO (M08)	2-8 Wood Market Kelso Borders TD5 7AX			

To contact your local Zanussi Service Force Centre telephone **08705 929 929**

MIDLANDS		LONDON & EAST ANGLIA		SUNBURY (M63)	Unit 1a The Summit Hanworth Road Hanworth Ind. Estate Sunbury on Thames TW16 5D
BIRMINGHAM (M18)	66 Birch Road East Wryley Road Ind. Estate Witton Birmingham B6 6DB	BECKENHAM (M79)	11a Gardener Ind. Estate Kent House Lane Beckenham Kent BR3 1QZ	SOUTH EAST	
BOURNE (M44)	Manning Road Ind. Estate Pinfold Road Bourne PE10 9HT	CHELMSFORD (M47)	Hanbury Road Widford Ind. Estate Chelmsford Essex CM12 3AE	ASHFORD (M58)	Unit 2 Bridge Road Business Est. Bridge Road Ashford Kent TN2 1BB
BRIDGNORTH (M72)	68 St. Mary's Street Bridgnorth Shropshire WV16 4DR	COLINDALE (M53)	Unit 14 Capitol Park Capitol Way Colindale London NW9 0EQ	FLEET (M59)	Unit 1 Redsfield Ind. Estate Church Crookham Fleet Hampshire GU13 0RD
GLOUCESTER (M23)	101 Rycroft Street Gloucester GL1 4NB	ELTHAM (M78)	194 Court Road Mottingham Eltham London SE9 4EW	HAYWARDS HEATH (M55)	21-25 Bridge Road Haywards Heath Sussex RH16 1UA
HEREFORD (M31)	Unit 3 Bank Buildings Cattle market Hereford HE4 9HX	ENFIELD (M49)	284 Alma Road Enfield London EN3 7BB	SOUTH WEST	
HIGHAM FERRERS (M51)	30 High Street Higham Ferrers Northants NN10 8BB	GRAVESEND (M57)	Unit B4 Imperial Business Estate Gravesend Kent DA11 0DL	BARNSTAPLE (M30)	Main Road Fremington Barnstaple North Devon EX31 2NT
ILKESTON (M43)	Unit 2 Furnace Road Ilkeston DE7 5EP	HARPENDEN (M46)	Unit 4 Riverside Estate Coldharbour Lane Harpenden AL5 4UN	BOURNEMOUTH (M26)	63-65 Curzon Road Bournemouth Dorset BH1 4PW
LEICESTER (M22)	Unit 7 Oaks Ind. Estate Coventry Road Narborough Leicestershire LE0 5GF	LETCHWORTH (M50)	16-17 Woodside Ind. Estate Works Road Letchworth Herts SG6 1LA	BRIDGEWATER (M35)	6 Hamp Ind. Estate Bridgewater Somerset TA6 3NT
LINCOLN (M40)	Unit 8 Stonefield Park Clifton Street Lincoln LN5 8AA	LONDON (M76)	2/4 Royal Lane Yiewsley West Drayton Middlesex UB7 8DL	BRISTOL (M25)	11 Eldon Way Eldonwall Trading Bristol Avon BS4 3QQ
NEWCASTLE UNDER LYME (M12)	18-21 Croft Road Brampton Ind. Estate Newcastle under Lyme Staffordshire ST5 0TW	MAIDENHEAD (M60)	Reform Road Maidenhead Berkshire SL6 8BY	EMSWORTH (M33)	266 Main Road Southbourne Emsworth PO10 8JL
REDDITCH (M20)	13 Thornhill Road North Moons Moat Redditch Worcestershire B98 9ND	MOLESEY (M61)	10 Island Farm Avenue West Molesey Surrey KT8 2UZ	ISLE OF WIGHT (M34)	Unit 8 Enterprise Court Ryde Business Park Ryde Isle of Wight PO33 1DB
TAMWORTH (M19)	Unit 3 Sterling Park Claymore Tamworth B77 5DO	NEWBURY (M24)	9 Pipers Court Berkshire Drive Thatcham Berkshire RG19 4ER	NEWTON ABBOT (M29)	Unit 2 Zealley Ind. Estate Kingsteignton Newton Abbot S. Devon TQ12 3TD
WORCESTER (M73)	Units 1 & 2 Northbrook Close Gregorys Mill Ind. Estate Worcester WR3 8BP	IPSWICH (M48)	Unit 6C Elton Park Business Centre Hadleigh Road Ipswich IP2 0DD	REDRUTH (M36)	Unit 7D Pool Ind. Estate Wilson Way Redruth Cornwall TR15 3QW
		NORWICH (M52)	2b Trafalgar Street Norwich NR1 3HN		

Zanussi Guarantee Conditions

Standard guarantee conditions

We, Zanussi undertake that if, within 12 months of the date of the purchase, this Zanussi appliance or any part thereof is proved to be defective by reason only of faulty workmanship or materials, we will, at our option, repair or replace the same FREE OF ANY CHARGE for labour, materials or carriage on condition that:

- The appliance has been correctly installed and used only on the electricity supply stated on the rating plate.
- The appliance has been used for normal domestic purposes only, and in accordance with the manufacturer's instructions.
- The appliance has not been serviced, maintained, repaired, taken apart or tampered with, by any person not authorised by us.

All service work under this guarantee must be undertaken by a Zanussi Service Force Centre.

Any appliance or defective part replaced shall become the Company's property.

This guarantee is in addition to your statutory and other legal rights.

Home visits are made between **8.30am** and **5.30pm** Monday to Friday. Visits may be available outside these hours in which case a **premium** will be charged.

Exclusions

This guarantee does not cover:

- Damage or calls resulting from transportation, improper use or neglect, the replacement of any light bulbs or removable parts of glass or plastic.
- Costs incurred for calls to put right an appliance which is improperly installed or calls to appliances outside the United Kingdom.
- Appliances found to be in use within a commercial environment, plus those which are subject to rental agreements.
- Products of Zanussi manufacture which are NOT marketed by Zanussi.

European guarantee



If you should move to another country within Europe then your guarantee moves with you to your new home subject to the following qualifications:

- The guarantee starts from the date you first purchased your product.
- The guarantee is for the same period and to the same extent for labour and parts as exists in the new country of use for this brand or range of products.
- The guarantee relates to you and cannot be transferred to another user.
- Your new home is within the European Community (EC) or European Free Trade Area.
- The product is installed and used in accordance with our instructions and is only used domestically, i.e. a normal household.
- The product is installed taking into account regulations in your new country.

Before you move please contact your nearest Customer Care Centre, listed below, to give them details of your new home. They will then ensure that the local Service Organisation is aware of your move and able to look after you and your appliances.

France	Senlis	+33 (0)344 62 29 99
Germany	Nurnberg	+49 (0)911 323 2600
Italy	Pordenone	+39 (0)1678 47053
Sweden	Stockholm	+46 (0)8 738 79 50
UK	Slough	+44 (0)1753 219897

Installation Instructions

-  It is dangerous to alter the specifications or attempt to modify this product in any way.
-  Care must be taken to ensure that the appliance does not stand on the electrical supply cable.
-  Any electrical work required to install this appliance should be carried out by a qualified electrician or competent person.

Technical Specifications

DIMENSIONS	Height Width Depth	85 cm (33.5") 60 cm (23.6") 60 cm (23.6")
POWER SUPPLY VOLTAGE TOTAL POWER ABSORBED		230-240 V/50 Hz 2700 W (13A)
MAXIMUM RECOMMENDED LOAD	Cotton, linen Synthetics, delicates	5 kg (11 lbs) 2.5 kg (5 lbs)
DRUM VOLUME		108 l

-  This appliance complies with the following E.E.C. Directives:
- 73/23 EEC of 19.2.73 (Low Voltage Directive) and subsequent modifications;
 - 89/336 EEC of 3.5.89 (Electromagnetic Compatibility Directive) and subsequent modifications.

Positioning

It is recommended that, for your convenience, the dryer is positioned close to your washing machine.

The tumble dryer must be installed in a clean place, where dirt does not build up.

Air must be able to circulate freely all round the appliance. Do not obstruct the front ventilation grille or the air intake grilles in the back of the machine.

To keep vibration and noise to a minimum when the dryer is in use, it should be placed on a firm, level surface.

Once in its permanent operating position, check that the dryer is absolutely level with the aid of a spirit level. If it is not, raise or lower the four adjustable feet until it is.

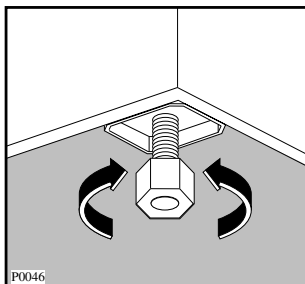

The feet must never be removed.

Do not restrict the floor clearance through deep-pile carpets, strips of wood or similar. This might cause heat build-up which would interfere with the operation of the appliance.

Important

When operating the tumble dryer, the room temperature must not exceed 35°C, as it may affect the performance of the appliance.

Stacking kit

A special stacking kit is available through your dealer, to enable the mounting of the dryer on top of your washing machine.

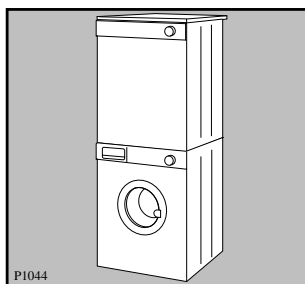

Door Reversal Instructions

The appliance is supplied with the door opening from right to left. If you wish to change the opening direction, proceed as follows (see picture A):

1. Unhook door stopper «A» from its seat «a» and loosen from hole «b» by a 90° rotation.
2. Remove the plastic plug from hole «c» by a 90° rotation and re-fix in hole «b».
3. Unscrew hinge «B» (loosen the 2 screws, holding the door securely) and lower the door from the top pivot.
4. Re-insert pin «F» from the door above and below on opposite sides respectively.
5. Loosen door catch «C» by pressing both lugs together (see small illustration).
6. Loosen opposite plastic part «D» as in step 5 (you may need to use a screwdriver to assist in both steps 5 and 6).
7. Interchange and insert parts «C» and «D».
8. Remove screws «E» and refit on the opposite side. Fix hinge «B» on the right handside. Do not fully tighten the screws.

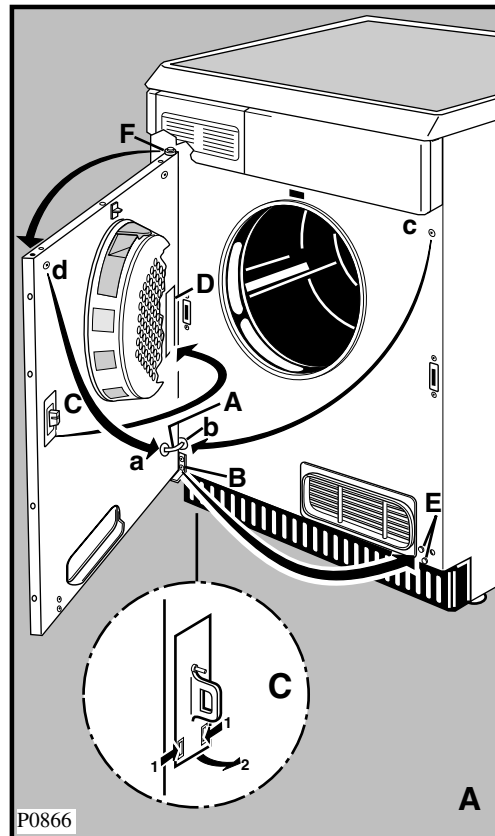

9. To mount door, see picture B:
 - First locate into upper right hand hole with upper pin «F».
 - Then place lower pin into the hinge «B» at the bottom of the door.
 - Align door before tightening hinge.
 - Tighten hinge.
10. Remove the plug from hole «d» and refix in hole «a» (Fig. A).
11. Fix door stopper «A» in hole «c» by 90° rotation.
12. Hook door stopper «A» into hole «d».

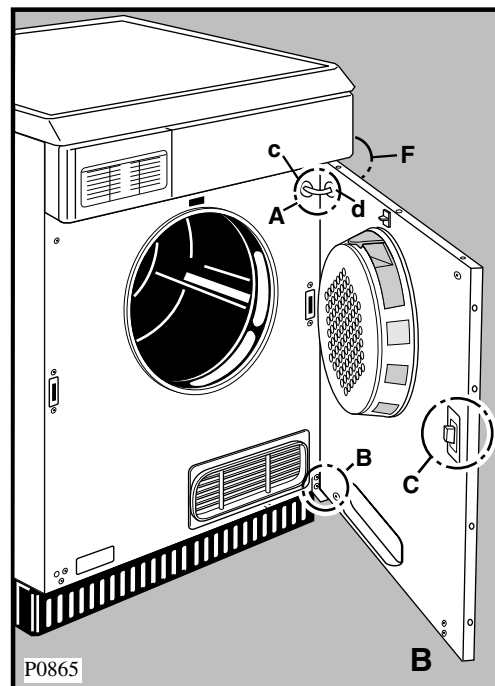

Electrical connection

Any electrical work required to install this appliance should be carried out by a qualified electrician or competent person.

WARNING: THIS APPLIANCE MUST BE EARTHED.



The manufacturer declines any liability should this safety measure not be observed.

Before switching on, make sure the electricity supply voltage is the same as that indicated on the appliance's rating plate.

The appliance is supplied with a 13amp plug fitted. In the event of having to change the fuse in the plug supplied, a 13amp ASTA approved (BS1363A) fuse must be used.

Should the plug need to be replaced for any reason, proceed as described below.

The wires in the mains lead are coloured in accordance with the following code:

Green and Yellow	- Earth
Blue	- Neutral
Brown	- Live

The wire coloured green and yellow must be connected to the terminal marked with the letter «E» or by the earth symbol \perp or coloured green and yellow.

The wire coloured blue must be connected to the terminal «N» or coloured black.

The wire coloured brown must be connected to the terminal marked «L» or coloured red.

Upon completion there must be no cut, or stray strands of wire present and the cord clamp must be secure over the outer sheath.

WARNING:



A cut off plug inserted into a 13 amp socket is a serious safety (shock) hazard. Ensure that the cut off plug is disposed of safely.

The power supply cable must be easily accessible after installing the machine.

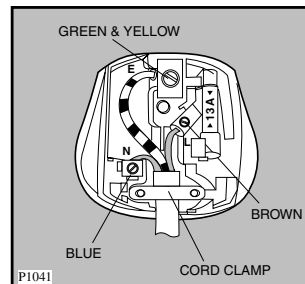

Permanent connection

In the case of permanent connection it is necessary that you install a double pole switch between the appliance and the electricity supply (mains), with a minimum gap of 3mm between the switch contacts and of a type suitable for the required load in compliance with the current electrical regulations.

The switch must not break the yellow and green earth cable at any point.

 **From the Electrolux Group. The world's No. 1 choice.**

The Electrolux Group is the world's largest producer of powered appliances for kitchen, cleaning and outdoor use. More than 55 million Electrolux Group products (such as refrigerators, cookers, washing machines, vacuum cleaners, chain saws and lawn mowers) are sold each year to a value of approx. USD 14 billion in more than 150 countries around the world.