

System Configuration Guide (V.6)

(November / 1999)



Notes	P2
teamserver HS900	P9
teamserver M800 series	P11
teamserver L800 series	P13
teamserver G800 series	P14
teamserver C800 series	P15
teamserver C300 series	P16
teamserver C350ie	P17
teamserver Network Cards	P17
teamserver Internal Devices	P18
teamserver External Devices	P19
teamserver Rackmount	P20
Hardware	P21

Index
The numbers on the left hand side of each page correspond to the various options available with teamservers as follows :
① CPU slot
② RAM module slot
③ 3.5 inch HDD Bay
④ 5 inch Bay
⑤ RS-232C
⑥ PCI slot
⑦ ISA slot
⑧ Redundant PSU
⑨ Others

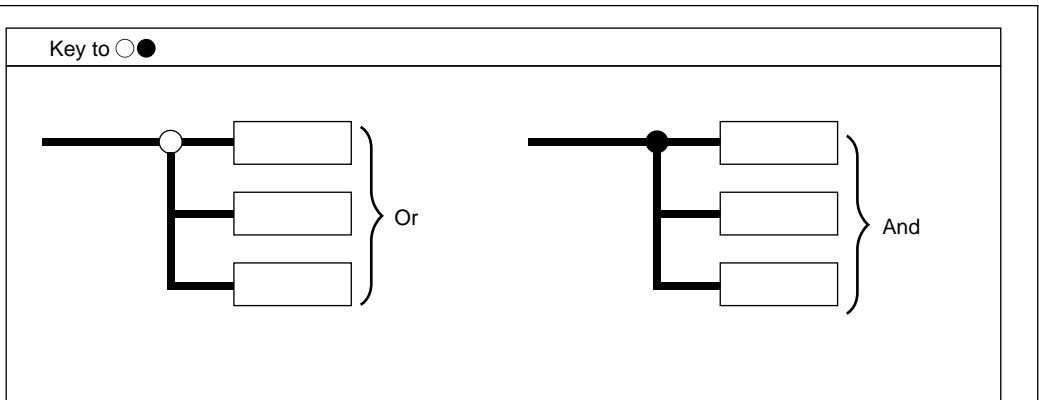

This System Configuration Guide (V.6) introduces PentiumIII 450MHz, 500MHz, 550MHz, 600MHz and PentiumIII Xeon 550MHz models and withdraws all old models.

Please refer to <http://www.fujitsu.co.jp/hypertext/InfoPro/msp/teamserver/config.html> for old models.

Mounting internal devices in HS900

In HS900, there are two HDD bays (9GB/18GB/36GB disks are available) as system disks.

Storage System (GP5UR1DC4) is required for data storage.

HS900 has no internal 5" bay in chassis, so Backup Cabinet (GP5UR1BC1) is required to mount backup devices.

Mounting internal HDDs in M800i

SCSI Card (GP5-127) or RAID Card (GP5-144/146) is required to setup hard disks.

Storage System (GP5UR1DC4) is required when more than 7HDDs are installed. 14HDDs in total can be mounted in Pedestal version.

Mounting internal HDDs in L800i

L800i have eight HDD bays and up to six 36.4GB HDD can be mounted.

36.4GB HDD cannot be mounted in bays #7 and #8. However 18.2GB HDD can be mounted.

Mounting internal HDDs in G800i, C800i and C300i (except C850ie and C350ie)

G800i, C800i and C300i (except C850ie and C350ie) have eight HDD bays and 18.2GB HDD (1"height) can be mounted.

RCI(Remote Console Interface)

RCI(Remote Console Interface) support

The figure below indicates the availability of the RCI function on each server type.

O: Available(Std.), ●: Available(Opt.), X : N/A
 -: No server product type

Product	Pedestal	Rack
C300 series	X	-
C800 series	X	X
G800 series	X	O
L800 series	●	O
M800 series	O	O
HS900	-	O

Restriction of Operating System (M800i/HS900)

Windows NT Server 4.0 supports up to 4CPUs and 4GB of memory.

Windows NT Server 4.0 Enterprise Edition is required for more than 4CPUs and 4GB of Memory.

Mounting additional memory

(HS900)

A memory board with 16slots is standard equipment and up to 16GB memory can be mounted. When you use over 16memory slots, an additional Memory Board (GP5-RB201) is required. When using two memory boards in HS900, the same memory size must be mounted on each board.

(M800i)

Memory must be expanded in bank units by mounting four similar capacity DIMMs in one bank. DIMMs must also be mounted in ascending order of memory capacity alternately on the two RAM base cards.

(L800i)

Mount the same capacity DIMM's in units of four. (Mounting of DIMM's with different capacities or a set of less than four DIMM's is not allowed)

Mount the DIMM's in ascending order of their capacity. Use DIMM slots in the order from bank A (J1 to J4) to bank D (J13 to J16)

(G800i/C800i/C300i)

The motherboard has four slots for RAM modules (including standard equipment), install RAM modules in slot number order. (teamserver C3xxi has three slots)

Additional PSU in G800i

When a DLT unit (GP5-DL351) is mounted, an additional PSU (total two PSU) is required.

The restriction of the mount of 2 CPUs, 5HDD or 3 PCIs is cancelled.

S.M.A.R.T.function

S.M.A.R.T. function is available in the combinations shown below:

■ : Corresponds , x:Does not correspond , -:N/A

Models	Internal Hard disk units										Hard disk cabinet					
	IDE		SCSI Hard disks								GP5UR1DC4/GP5MS622A					
	Standard equipment	Standard equipment	SCSI card				RAID card				SCSI card			RAID card		
		GP5-125	GP5-126	GP5-127	GP5U141	GP5U142	GP5-143	GP5-144	GP5-146	GP5-125	GP5-126	GP5-127	GP5U141	GP5-144	GP5-146	
C300i (GP5C300-375)	■	-	■	-	-	X	-	■	-	-	■	-	-	X	-	-
C300i (GP5C377-379)	■	-	-	■	-	X	-	■	-	-	-	-	■	X	-	-
C800i	-	■	-	-	-	X	-	■	-	-	■	-	-	X	-	-
G800i	-	■	-	-	-	-	X	-	■	■	-	-	■	X	■	■
L800i	-	■	-	-	-	-	-	-	■	■	-	-	■	-	■	■
M800i	-	-	-	-	■	-	-	-	■	■	-	-	■	-	■	■
HS900	-	■	-	-	-	-	-	-	■	■	-	-	■	-	■	■

Hard disk cabinet/RAID card/SCSI card

●Hard disk cabinet

GP5MS622A: Up to four can be connected to C300i, C800i, G800i and L800i.
 : Up to six can be connected to M800i.

Note: The Operating System must be installed on an internal hard disk.

●RAID card (GP5U141/GP5-144/GP5-146)

Up to two Hard disk cabinets can be connected with one RAID card.

(Up to three can be connected with one GP5-144 card)

When connecting two GP5MS622A, GP5-144 RAID card is required on G800i, L800i, M800i and HS900.

One GP5U141 cannot be used to connect external disk array (Hard disk cabinet) and internal disk array.

One GP5-146 in G/L800i cannot be used to connect external disk array (Hard disk cabinet) and internal disk array.

One RAID card can not be used for both internal and external array configuration. 2 RAID cards are required in this case.

GP5-144/146 can only be used with GP5-144/146, they cannot be mixed with GP5U141/142/-143.

Up to two GP5-146 can be used for internal array configuration in G800i.

When connecting three RAID cards in G800i, the internal HDD must be connected using GP5-144.

●RAID card (GP5U142/GP5-143)

Only for use with internal HDD.

Only one RAID card can be used per server.

●SCSI card (GP5-125/GP5-126/GP5-127)

Internal and external devices cannot be connected to the same SCSI card.

Maximum number of daisy chain connections allowed :

(1) Up to four external devices (but not Hard disk cabinets) can be connected by daisy chain.

(2) Only one Hard disk cabinet can be connected. (Daisy chain connection is not available)

Disk array configuration

- Physical pack..... A collection of physical HDDs comprising a RAID.
- Logical drive..... Logical drive (ex. D:) seen by the Operating System.
- Partition..... One of the logical access units into which a logical drive is divided.

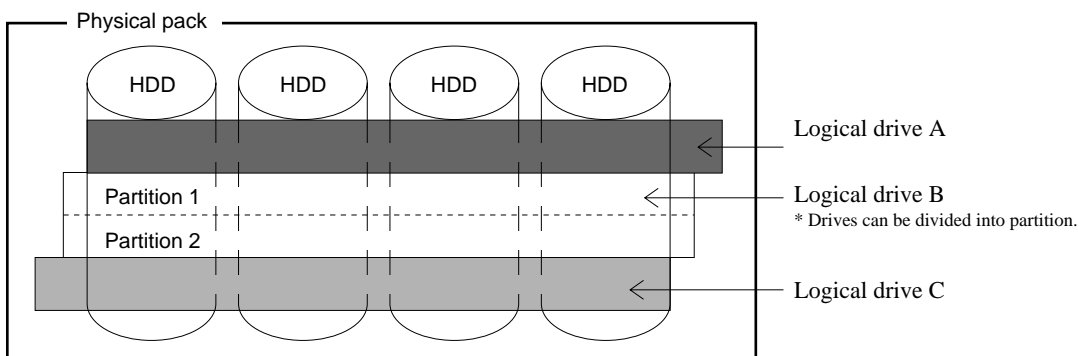

<Restrictions>

- (1) Physical pack must contain the same type(size) of HDDs.
- (2) Maximum logical drive size is 2TB (GP5U141/U142/-143/-144/-146).

NOTES

(3) The number of HDDs comprising a physical pack is as shown below.

RAID Level	Description	HDDs	Capacity of logical drives
RAID 0	(The data is broken down into blocks, each on a separate disk drive)	- 2~8	The capacity of logical drive is same as the capacity of connected HDD.
RAID 1	(Duplicates the disk and writes the same data onto two disks.)	- 2	The capacity of the logical drive is half the capacity of connected HDD.
RAID 5	(The data is broken down into blocks and each block is written together with parity bits on a separate disk drive.)	- 3~8	The capacity of each logical drive is the number of connected HDDs - 1).
RAID 6	(Duplicates the disk and broken down into blocks, each on a separate disk. (RAID0+1))	- 3~8	The capacity of each logical drive is the half the capacity of connected HDD. (GP5-143/144)

(4) The same RAID level must be used when dividing a physical pack into a number of logical drives.

(5) A physical pack must contain only HDDs which are connected by the same RAID card.

(6) A RAID card can support more than one physical pack. (even if different RAID levels)

(7) Internal and external array devices cannot be connected to the same RAID card. (except for M8xx)

Additional bus-slots

The number of bus-slots which can be used depends on each model.

Product	Number of standard bus-slots	Product ID	REMARKS
HS900	PCI(64bit-66MHz)x4 PCI(64bit-33MHz)x6	GP5T9A32R GP5T9A22R	Two PCIs(64bit-33MHz) are used for standard LAN card and standard RAID card.
M890ie M880ie	PCI(64bit)x5 PCI(32bit)x5 PCI/ISA(32bit)x1	GP5M895AL GP5M895BL GP5M885AL GP5M885BL	LAN card is mounted in a PCI(32bit)slot.
L890ie L880ie L870ie	PCIx6 PCI/ISAx1	GP5L895L GP5L895LR GP5L885L GP5L885LR GP5L875L GP5L875LR	LAN card is mounted in a PCIslot.
G870ix G870ie G870i	PCIx4 PCI/ISAx1 ISAx1	GP5G879L GP5G879LR GP5G878L GP5G878LR GP5G877L GP5G877LR	All of the slots are available
C870ix C870ie C870i C850ie	PCIx3 ISAx2	GP5C876 GP5C876R GP5C875 GP5C875R GP5C871 GP5C871R GP5C855 GP5C855R	All of the slots are available
C370ix C370ie C370i C350ie	PCIx4 ISAx1	GP5C379 GP5C378 GP5C377 GP5C355	All of the slots are available

NOTES

Number of mountable optional cards

HS900

Cards	Product ID	Bus	Maximum number of cards mounted	Total	REMARKS
RAID card (Ultra2 Wide LVB)	Standard equipment	PCI64	1	8	
RAID card (Ultra2 Wide LVD)	GP5-144	PCI64	7		
RAID card (Ultra2 Wide LVD)	GP5-146	PCI64	7		
SCSI card (Ultra2 Wide LVD)	GP5-127	PCI64	6		
SCSI card (Ultra Wide Diff)	GP5-123	PCI64	2		
Fibre Channel Card	GP5-FC101	PCI64	2	2	
LAN card (1000Base-SX)	GP5-183	PCI64	1	4	
LAN card (100Base-TX)	GP5-185 Standard equipment	PCI64	3		
LAN card (100Base-TX)	Standard equipment	PCI64	1		
Server Monitor Module	GP5USM103	PCI64	1	1	

M800i

Cards	Product ID	Bus	Maximum number of cards mounted	Total	REMARKS
RAID card (Ultra2 Wide LVD)	GP5-144	PCI64	5	5	
RAID card (Ultra2 Wide LVD)	GP5-146	PCI64	4		
SCSI card (Ultra2 Wide LVD)	GP5-127	PCI64	5		For external disk array
SCSI card (Ultra Wide Diff)	GP5-123	PCI64	2		
Fibre Channel Card	GP5-FC101	PCI64	2	2	
LAN card (1000Base-SX)	GP5-183	PCI64	1	4	Mounted in PCI slot3(fixed)
LAN card (100Base-TX)	GP5-185 Standard equipment	PCI32	3		
LAN card (100Base-TX)	Standard equipment	PCI32	1		
Server Monitor Module	GP5USM102	PCI32	1	1	

* Up to six cards can be mounted when an ISA card is used.

L800i

Cards	Product ID	Bus	Maximum number of cards mounted	Total	REMARKS
SCSI card (Ultra Wide Diff)	GP5-123	PCI	2	7*	For external disk array GP5-127 can be used to connect internal SCSI devices(GP5-DL351,GP5-ML301).
SCSI card (Ultra2 Wide LVD)	GP5-127	PCI	3		
RAID card (Ultra2 Wide LVD)	GP5-144	PCI	3		
RAID card (Ultra2 Wide LVD)	GP5-146	PCI	2		
Fibre Channel Card	GP5-FC101	PCI	2		
LAN card (1000Base-SX)	GP5-183	PCI	1	4	It must be mounted in PCI-A2
LAN card (100Base-TX)	GP5-185 Standard equipment	PCI	3		Mounted in PCI-A1 (fixed)
LAN card (100Base-TX)	Standard equipment	PCI	1		
Server Monitor Module	GP5USM102	PCI	1		It must be mounted in PCI-A3

* Up to six cards can be mounted when an ISA card is used.

G800i

Cards	Product ID	Bus	Maximum number of cards mounted	Total	REMARKS
SCSI card (Ultra Wide Diff)	GP5-123	PCI	2	5	For external disk array Use for external SCSI devices
SCSI card (Ultra2 Wide LVD)	GP5-127	PCI	3		
RAID card (Ultra Wide SE)	GP5U141	PCI	2		Internal/external array configuration Only for internal array configuration Internal/external array configuration Cannot be used with GP5U141/142 Internal/external array configuration Cannot be used with GP5U141/142
RAID card (Ultra Wide)	GP5U142	PCI	1		
RAID card (Ultra2 Wide LVD)	GP5-144	PCI	3		
RAID card (Ultra2 Wide LVD)	GP5-146	PCI	2		
Fibre Channel Card	GP5-FC101	PCI	2		
LAN card (1000Base-SX)	GP5-183	PCI	1	3	
LAN card (100Base-TX)	GP5-184	PCI	3		
Server Monitor Module	GP5USM102	PCI	1		

C800i

Cards	Product ID	Bus	Maximum number of cards mounted	Total	REMARKS
RAID card (Ultra Wide SE)	GP5U141	PCI	2	3	Internal/external array configuration Only for internal array configuration
RAID card (Ultra Wide SE)	GP5-143	PCI	1		
SCSI card	GP5-125	PCI	3		Only for external SCSI devices
LAN card (1000Base-SX)	GP5-183	PCI	1	3	
LAN card (100Base-TX)	GP5-185	PCI	3		
Server Monitor Module	GP5USM102	PCI	1		

C300i (GP5C377-379)

Cards	Product ID	Bus	Maximum number of cards mounted	Total	REMARKS
SCSI card	GP5-126	PCI	1	3	
SCSI card	GP5-127	PCI	3		
RAID card (Ultra Wide SE)	GP5U141	PCI	2		Internal/external array configuration
RAID card (Ultra2 Wide LVD)	GP5-143	PCI	1		
LAN card (100Base-TX)	GP5-185	PCI	3	3	
Server Monitor Module	GP5USM102	PCI	1	1	

C300i (GP5C300-375)

Cards	Product ID	Bus	Maximum number of cards mounted	Total	REMARKS
SCSI card	GP5-125	PCI	3	3	
RAID card (Ultra Wide SE)	GP5U141	PCI	2		
RAID card (Ultra2 Wide LVD)	GP5-143	PCI	1		Internal/external array configuration Only for internal array configuration (Cannot be used with GP5-143) Only for internal array configuration (Cannot be used with GP5U142)
LAN card (100Base-TX)	GP5-185	PCI	3	3	
Server Monitor Module	GP5USM102	PCI	1	1	

NOTES

The differentiation between current models and new models

1. Connectivity/Use of new product options with older models

I. The figure below indicates the applicability of new options on previous (released before August, 1999) models

Figure 1

Product	Option	Product ID	Applicable to older	Remarks
C300series	Hard disk drive-9GB	GP5-HD9G3	O	Please refer to Figure2
	Hard disk drive-9GB	GP5-HD9G3B	O	Please refer to Figure2
	Hard disk drive-18GB	GP5-HD8G1	O	
	Hard disk drive-18GB	GP5-HD8G1B	O	
	Hard disk drive-13GB	GP5-HD3E1	O	
	LAN card	GP5-185	O	Successor of GP5-182/184
	SCSI card	GP5-127	X	
	SCSI card	GP5-126	X	
	RAID card	GP5-143	O	However, used as Ultrawide SCSI interface in older models
	SCSI cable	GP5-839	X	
		GP5-840	X	
	GP5-841	O	Successor of GP5-838	
	Hard disk cabinet	GP5MS622A	O	Successor of GP5MS621A
C800series	Hard disk drive-9GB	GP5-HD9G3	O	Please refer to Figure2
	Hard disk drive-9GB	GP5-HDH96	O	Please refer to Figure2
	Hard disk drive-18GB	GP5-HD8G1	O	Please refer to Figure2
	Hard disk drive-18GB	GP5-HDH83	O	Please refer to Figure2
	LAN card	GP5-185	O	Successor of GP5-182/184
	Hard disk cabinet	GP5S622A	O	Successor of GP5MS621A
G800 series	Hard disk drive-9GB	GP5-HDH96	O	Please refer to Figure2
	Hard disk drive-18GB	GP5-HDH83	O	Please refer to Figure2
	LAN card	GP5-185	O	Successor of GP5-182/184
	SCSI card	GP5-127	O	Successor of GP5-125/GP5-126
	RAID card	GP5-146	O	Successor of GP5-145 with Windows NT only For Netware/Intranetware, please use GP5-145
	Hard disk cabinet	GP5MS622A	O	Successor of GP5MS621A
	DLT unit	GP5-DL351	O	Two PSU (one is standard) are required when mounting GP5-DL351
L800 series	Hard disk drive-9GB	GP5-HDH97	O	Please refer to Figure2
	Hard disk drive-9GB	GP5-HDH98	O	Please refer to Figure2
	Hard disk drive-18GB	GP5-HDH84	O	Please refer to Figure2
	Hard disk drive-18GB	GP5-HDH85	O	Please refer to Figure2
	Hard disk drive-36GB	GP5-HDH61	O	New
	LAN card	GP5-185	O	Successor of GP5-182/184
	SCSI card	GP5-127	O	Successor of GP5-125/GP5-126
	RAID card	GP5-146	O	
	Hard disk cabinet	GP5MS622A	O	Successor of GP5MS621A
	RCI card	GP5-RC101	O	New for Pedestal type, Standard equipment for Rackmount type
	M800 series	Hard disk drive-9GB	GP5-HDH97	O
Hard disk drive-9GB		GP5-HDH98	O	Please refer to Figure2
Hard disk drive-18GB		GP5-HDH84	O	Please refer to Figure2
Hard disk drive-18GB		GP5-HDH85	O	Please refer to Figure2
Hard disk drive-36GB		GP5-HDH61	O	New
LAN card		GP5-185	O	Successor of GP5-182/184
SCSI card		GP5-127	O	Successor of GP5-125/GP5-126
RAID card		GP5-146	O	
Hard disk cabinet		GP5MS622A	O	Successor of GP5MS621A

II. Ultra wide or Ultra2 Wide on C300 series

The new C300 series (GP5C377, GP5C378, GP5C379) supports Ultra2 Wide SCSI.

To use new C300 series as an Ultra2 Wide system, Ultra2 Wide HDD, Ultra2 Wide SCSI (RAID) card and Ultra2 Wide SCSI cable are required

Previous models (GP5C300 to GP5C375 - Released Jul, 1999) cannot support Ultra2 Wide even if Ultra2 Wide SCSI HDD, card & cable are mounted.

For connection details, please refer to "Available SCSI cards for C300i"

Available SCSI card for C300i

(1) GP5C377/378/379 (Ultra2 Wide)

Connected device	SCSI card	Channel	Cable	Remarks
Internal HDD	GP5-126	Internal Channel (68pin)	GP5-839	Up to four HDDs
Internal Backup device	GP5-126	Internal Channel (50pin)	GP5-841	
	GP5-127	Internal Channel (68pin)	GP5-840	When using EIDE HDD or RAID, GP5-127 must be used instead of GP5-126*
Hard disk cabinet	GP5-127	External Channel (68pin)	GP5MU823A	

*SCSI card (GP5-126) is required for connecting SCSI HDD

(2) GP5C300-375 (Ultra wide)

Connected device	SCSI card	Channel	Cable	Remarks
Internal HDD (SCSI)	GP5-125	Internal Channel (68pin)	GP5-837	Up to four HDDs
Internal Backup device	GP5-125	Internal Channel (50pin)	GP5-841	
Hard disk cabinet	GP5-125	External Channel (68pin)	GP5MU823A	

of SCSI Channel of each SCSI card is as below:

SCSI card	Internal	External
GP5-125	2(68pin+50pin)	1(68pin)
GP5-126	2(68pin+50pin)	1(68pin)
GP5-127	1(68pin)	1(68pin)

2. Internal HDD

The HDD line-up has changed. The figure below indicates each product and its successor. Current and successor HDDs of the same size can be used together in the same physical pack.

Figure 2

Main unit	Product	Current HDD Product ID	Successor HDD Product ID	Remarks
C300 series	Hard disk drive-4GB	GP5-HD4G5	GP5-HD4G51	
	Hard disk drive-9GB	GP5-HD9G2	GP5-HD4G5B	For mounting in 5" bay
			GP5-HD9G3	
			GP5-HD9G3B	For mounting in 5" bay
C800 series	Hard disk drive-4GB	GP5-HD4G5	GP5-HD4G51	
	Hard disk drive-4GB	GP5-HDH44	GP5-HDH461	Can be used with GP5-HDH46
	Hard disk drive-9GB	GP5-HD9G3	GP5-HD9G3	
	Hard disk drive-9GB	GP5-HDH92	GP5-HDH96	Can be used with GP5-HDH95
G800 series	Hard disk drive-4GB	GP5-HDH44	GP5-HDH461	Can be used with GP5-HDH46
	Hard disk drive-4GB	GP5-HDH46	GP5-HDH461	
	Hard disk drive-9GB	GP5-HDH92	GP5-HDH96	Can be used with GP5-HDH95
	Hard disk drive-9GB	GP5-HDH95	GP5-HDH96	
L800 series	Hard disk drive-4GB	GP5-HDH45	GP5-HDH451	
M800 series	Hard disk drive-9GB	GP5-HDH93	GP5-HDH97	
	Hard disk drive-9GB	GP5-HDH94	GP5-HDH98	
	Hard disk drive-18GB	GP5-HDH81	GP5-HDH84	
	Hard disk drive-18GB	GP5-HDH82	GP5-HDH85	

Successor products of the same size can be used as additional HDD in a physical pack that contains current/previous products.

System Configuration

teamserver HS900

teamserver HS900 series

CPU: Pentium®III Xeon™ (550MHz) x 2(~8) , Cache (L1+L2) : 32KB+2MB/1MB, Internal Hard disk bay:(Hot-plug) 2bays,
2 x Ultra2 Wide SCSI Onboard, 2ch RAID Card, CD-ROM, LAN Card (Std.), Redundant Power Supply (Std.)/FAN (Std.),
Intel LANDesk® Server Manager/Servervisor, ServerWizard

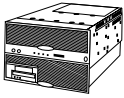

[Rackmount type]

- GP5T9A32R [Rackmount Type]
2CPU, Memory:1GB(ECC), HDD:Option
- GP5T9A22R [Rackmount Type]
2CPU, Memory:1GB(ECC), HDD:Option

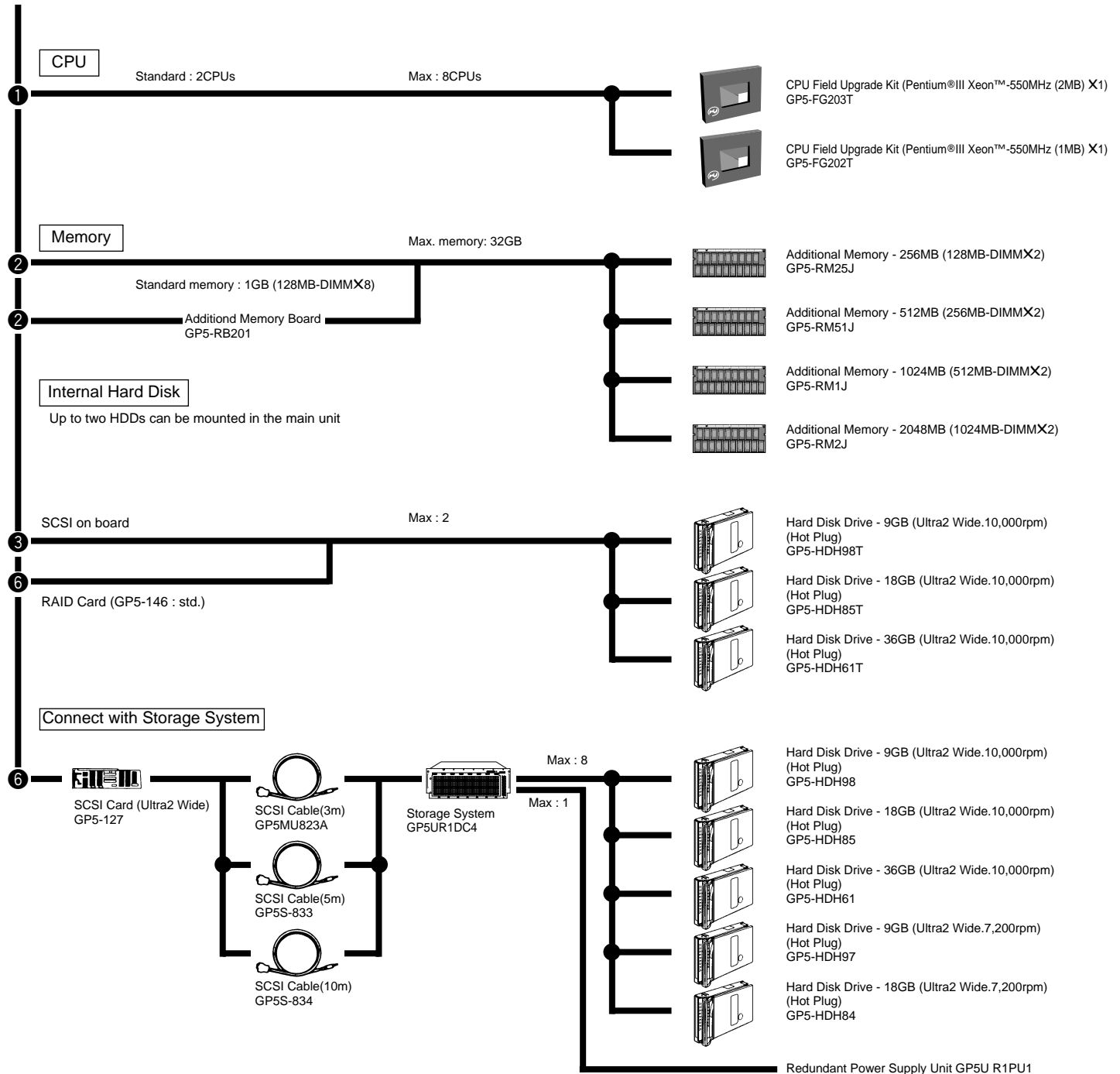

System Configuration

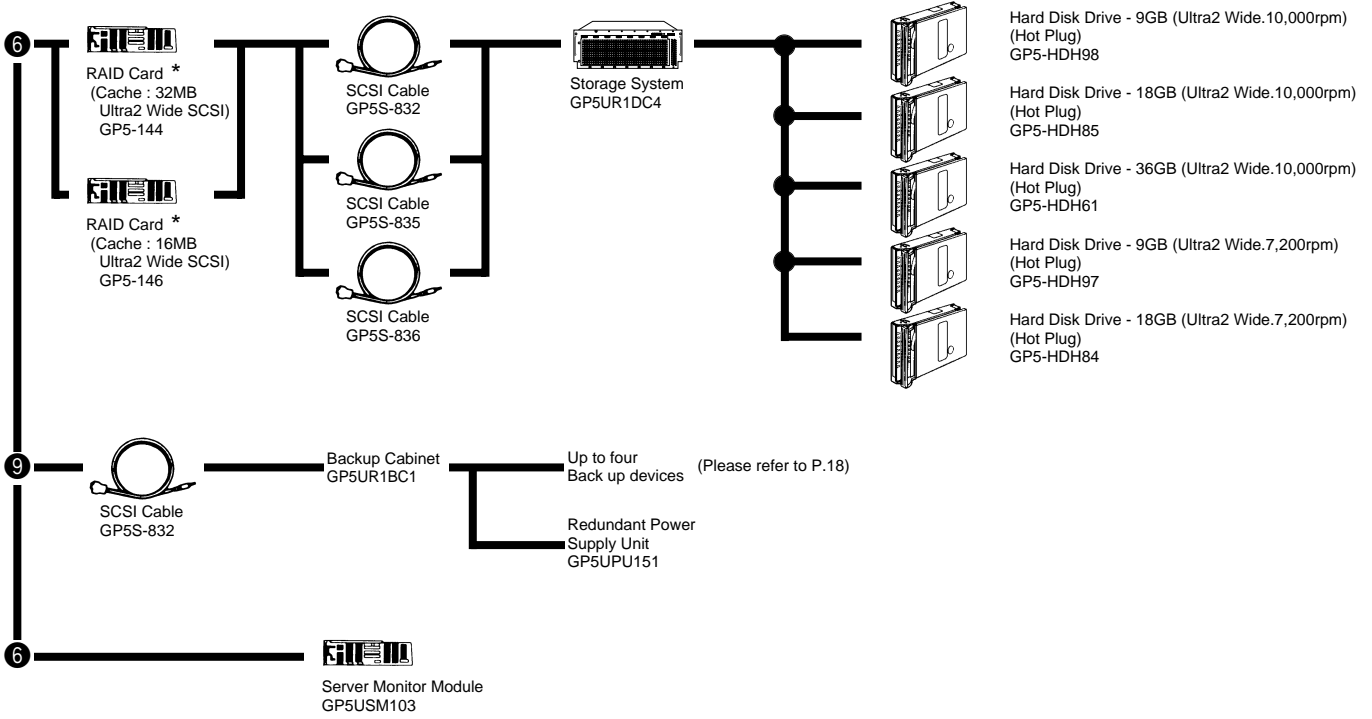

System Configuration

teamserver M800 series

teamserver M800 series

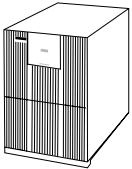

[Pedestal type]

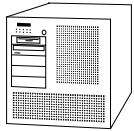

[Rackmount type]

CPU: Pentium®III Xeon™ (550MHz) x 1(~4) , Cache (L1+L2) : 32KB+2MB/1MB, Internal Hard disk bay:(Hot-plug) 14bays (Pedestal)/6bays(Rackmount)
 CD-ROM, LAN Card (Std.), Redundant Power Supply (Opt.)/FAN (Std.), Servervisor/ Intel LANDesk® Server Manager, ServerWizard

M890ie	GP5M895AL	[1CPU/Pedestal Type]
	GP5M895BL	[1CPU/Rackmount Type]
M880ie	GP5M885AL	[1CPU/Pedestal Type]
	GP5M885BL	[1CPU/Rackmount Type]

CPU

Max : 4CPUs



CPU Field Upgrade Kit (Pentium®III Xeon™
 -550MHz (2MB) X1)
 GP5-FG203



CPU Field Upgrade Kit (Pentium®III Xeon™
 -550MHz (1MB) X1)
 GP5-FG202

Memory

Max : 8GB

Standard memory : 256MB (64MB-DIMMX4)



Additional Memory- 256MB (64MB-DIMMX4)
 GP5-RM25G



Additional Memory - 512MB (128MB-DIMMX4)
 GP5-RM51G



AdditionalMemory- 1024MB (256MB-DIMMX4)
 GP5-RM1G

Internal Hard Disk

*Pedestal Type : Up to 14 (6 in standard, 8 in optional Storage System) disks can be installed.
 Rackmount Type : Up to 6 disks can be installed in a rackmount type node.

(1)Disk Addition / Duplexing



SCSI Card (Ultra2 Wide)
 GP5-127



Hard Disk Drive - 9GB (Ultra2 Wide,7,200rpm)
 (Hot Plug)
 GP5-HDH97



Hard Disk Drive - 9GB (Ultra2 Wide,10,000rpm)
 (Hot Plug)
 GP5-HDH98



Hard Disk Drive - 18GB (Ultra2 Wide,7,200rpm)
 (Hot Plug)
 GP5-HDH84



Hard Disk Drive - 18GB (Ultra2 Wide,10,000rpm)
 (Hot Plug)
 GP5-HDH85



Hard Disk Drive - 36GB (Ultra2 Wide,10,000rpm)
 (Hot Plug)
 GP5-HDH61

For pedestal type



SCSI Card (Ultra2 Wide)
 GP5-127



SCSI Cable(3m)
 GP5MU823A

For pedestal type

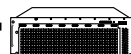

Storage System
 GP5UR1DC4



Hard Disk Drive - 9GB (Ultra2 Wide,7,200rpm)
 (Hot Plug)
 GP5-HDH97



Hard Disk Drive - 9GB (Ultra2 Wide,10,000rpm)
 (Hot Plug)
 GP5-HDH98



Hard Disk Drive - 18GB (Ultra2 Wide,7,200rpm)
 (Hot Plug)
 GP5-HDH84



Hard Disk Drive - 18GB (Ultra2 Wide,10,000rpm)
 (Hot Plug)
 GP5-HDH85



Hard Disk Drive - 36GB (Ultra2 Wide,10,000rpm)
 (Hot Plug)
 GP5-HDH61

Redundant Power Supply Unit
 GP5UR1PU1

System Configuration

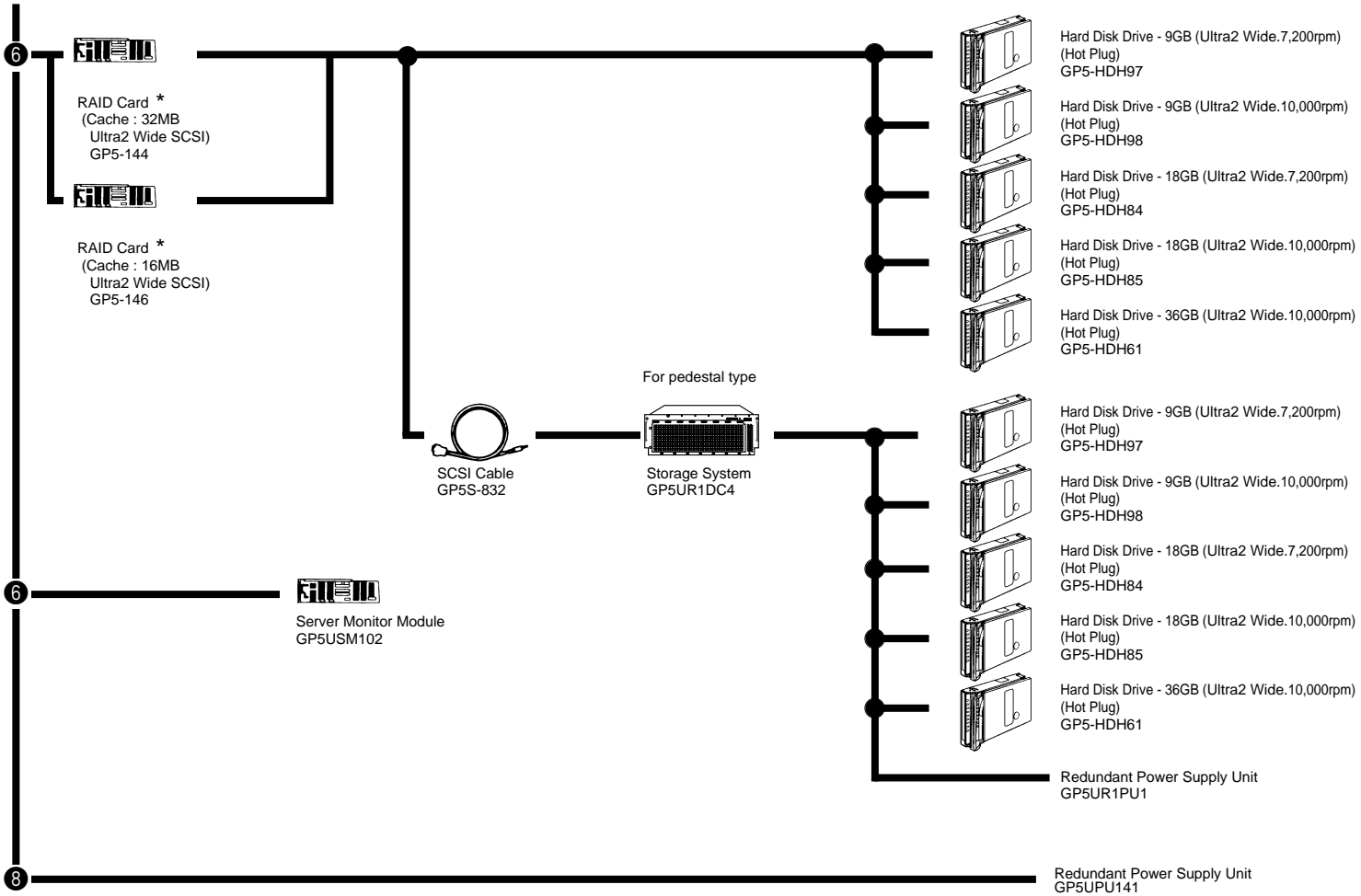

NOTE ; Please refer to P.20 for rackmounting instructions.

* For mounting restrictions, please see P.4

System Configuration

teamserver L800 series

teamserver L800 series

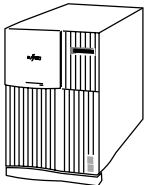

CPU: Pentium®III Xeon™ (550MHz) x 1(~4) , Cache (L1+L2) : 32KB+2MB/1MB/512KB, On board SCSI,
Internal Hard disk bay: 8bays (Hot-plug), CD-ROM, LAN Card (Std.), Servivisor/Intel LANDesk® Server Manager, ServerWizard

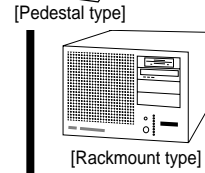

L890ie	GP5L895L	[1CPU/Pedestal Type] 1CPU(Cache:2MB), Memory:256MB(ECC), HDD:Option
	GP5L895LR	[1CPU/Pedestal Type] 1CPU(Cache:2MB), Memory:256MB(ECC), HDD:Option
L880ie	GP5L885L	[1CPU/Pedestal Type] 1CPU(Cache:1MB), Memory:256MB(ECC), HDD:Option
	GP5L885LR	[1CPU/Pedestal Type] 1CPU(Cache:1MB), Memory:256MB(ECC), HDD:Option
L870ie	GP5L875L	[1CPU/Pedestal Type] 1CPU(Cache:512KB), Memory:256MB(ECC), HDD:Option
	GP5L875LR	[1CPU/Pedestal Type] 1CPU(Cache:512KB), Memory:256MB(ECC), HDD:Option

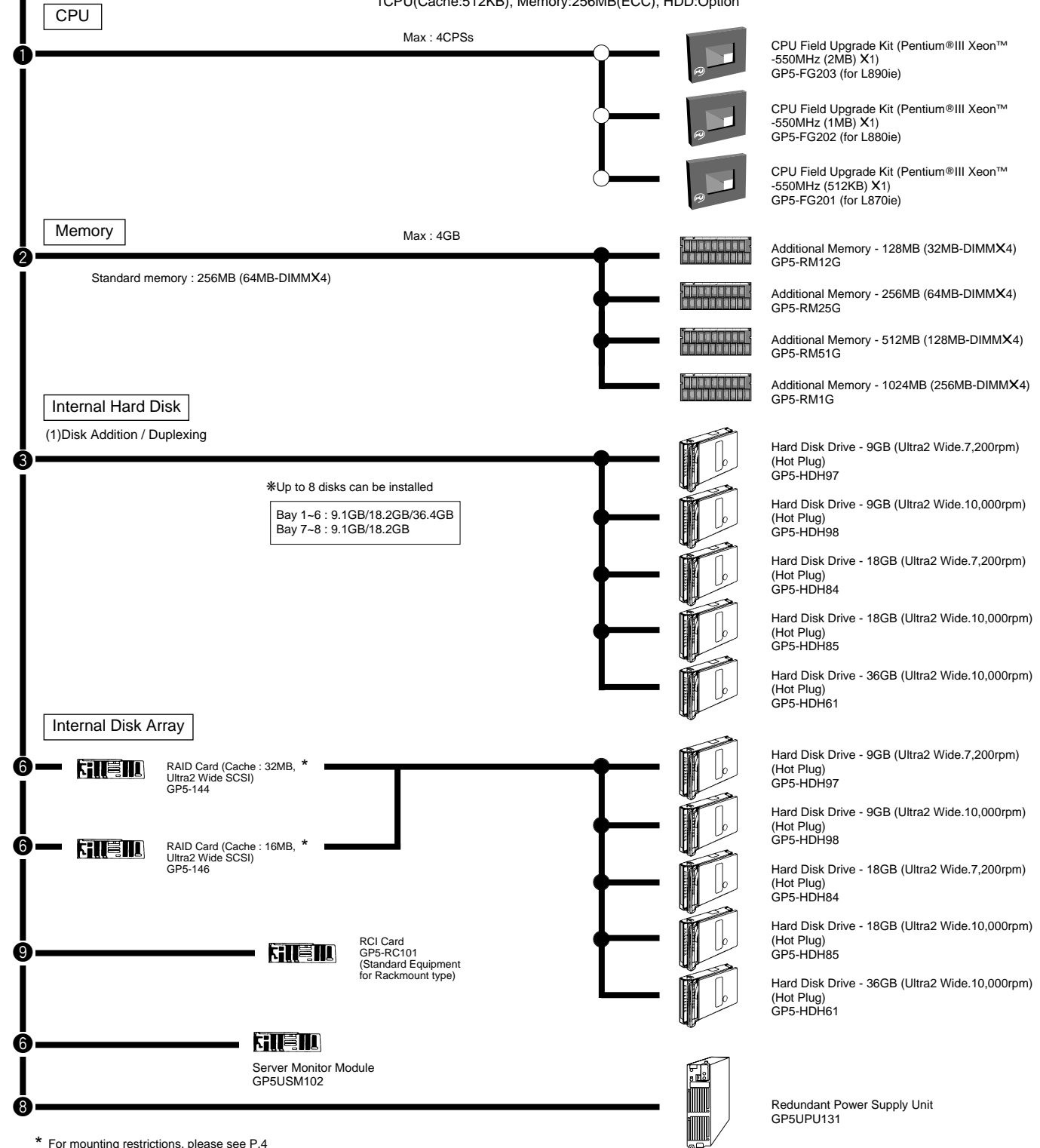

* For mounting restrictions, please see P.4

System Configuration

teamserver G800 series

teamserver G800 series

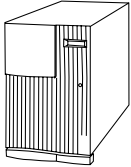

[Pedestal type]

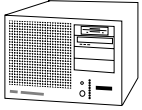

[Rackmount type]

CPU: Pentium®III (600MHz/550MHz/500MHz) x 1(~2) , Cache (L1+L2) : 32KB+512KB, On board SCSI, CD-ROM, Onboard LAN (Std.), Internal Hard disk bay: 8bays (Hot-plug), Servervisor/ Intel LANDesk® Server Manager, ServerWizard

G870ix	GP5G879L	[1CPU/Pedestal Type] 1CPU(PentiumIII 600MHz), Memory:256MB(ECC), HDD:Option
	GP5G879LR	[1CPU/Rackmount Type] 1CPU(PentiumIII 600MHz), Memory:256MB(ECC), HDD:Option
G870ie	GP5G878L	[1CPU/Pedestal Type] 1CPU(PentiumIII 550MHz), Memory:256MB(ECC), HDD:Option
	GP5G878LR	[1CPU/Rackmount Type] 1CPU(PentiumIII 550MHz), Memory:256MB(ECC), HDD:Option
G870i	GP5G877L	[1CPU/Pedestal Type] 1CPU(PentiumIII 500MHz), Memory:256MB(ECC), HDD:Option
	GP5G877LR	[1CPU/Rackmount Type] 1CPU(PentiumIII 500MHz), Memory:256MB(ECC), HDD:Option

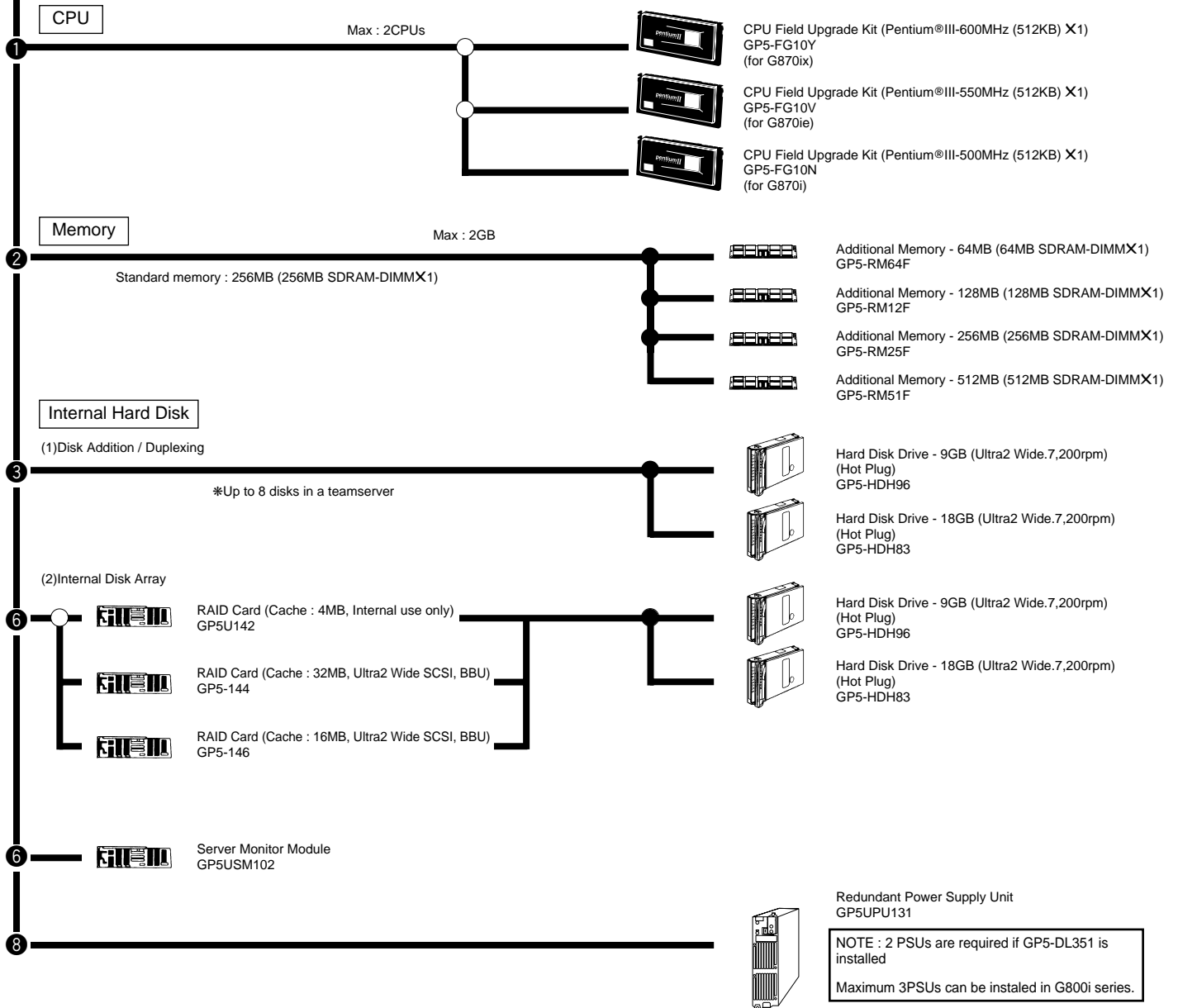

System Configuration

teamserver C800 series

teamserver C800 series

CPU: Pentium®III (600MHz/550MHz/500/450MHz)x 1(~2) , Cache (L1+L2) : 32KB+512KB, On board SCSI, CD-ROM, Onboard LAN (Std.), Internal Hard disk bay: 4bays (3xHot-plug), Servervisor/ Intel LANDesk® Server Manager, ServerWizard

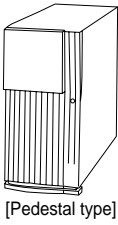

C870ix	GP5C876	[1CPU/Pedestal Type] 1CPU(PentiumIII 600MHz), Memory:128MB(ECC), HDD:Option
	GP5C876R	[1CPU/Rackmount Type] 1CPU(PentiumIII 600MHz), Memory:128MB(ECC), HDD:Option
C870ie	GP5C875	[1CPU/Pedestal Type] 1CPU(PentiumIII 550MHz), Memory:128MB(ECC), HDD:Option
	GP5C875R	[1CPU/Rackmount Type] 1CPU(PentiumIII 550MHz), Memory:128MB(ECC), HDD:Option
C870i	GP5C871	[1CPU/Pedestal Type] 1CPU(PentiumIII 500MHz), Memory:128MB(ECC), HDD:Option
	GP5C871R	[1CPU/Rackmount Type] 1CPU(PentiumIII 500MHz), Memory:128MB(ECC), HDD:Option
C850ie	GP5C855	[1CPU/Pedestal Type] 1CPU(PentiumIII 450MHz), Memory:128MB(ECC), HDD:Option
	GP5C855R	[1CPU/Rackmount Type] 1CPU(PentiumIII 450MHz), Memory:128MB(ECC), HDD:Option

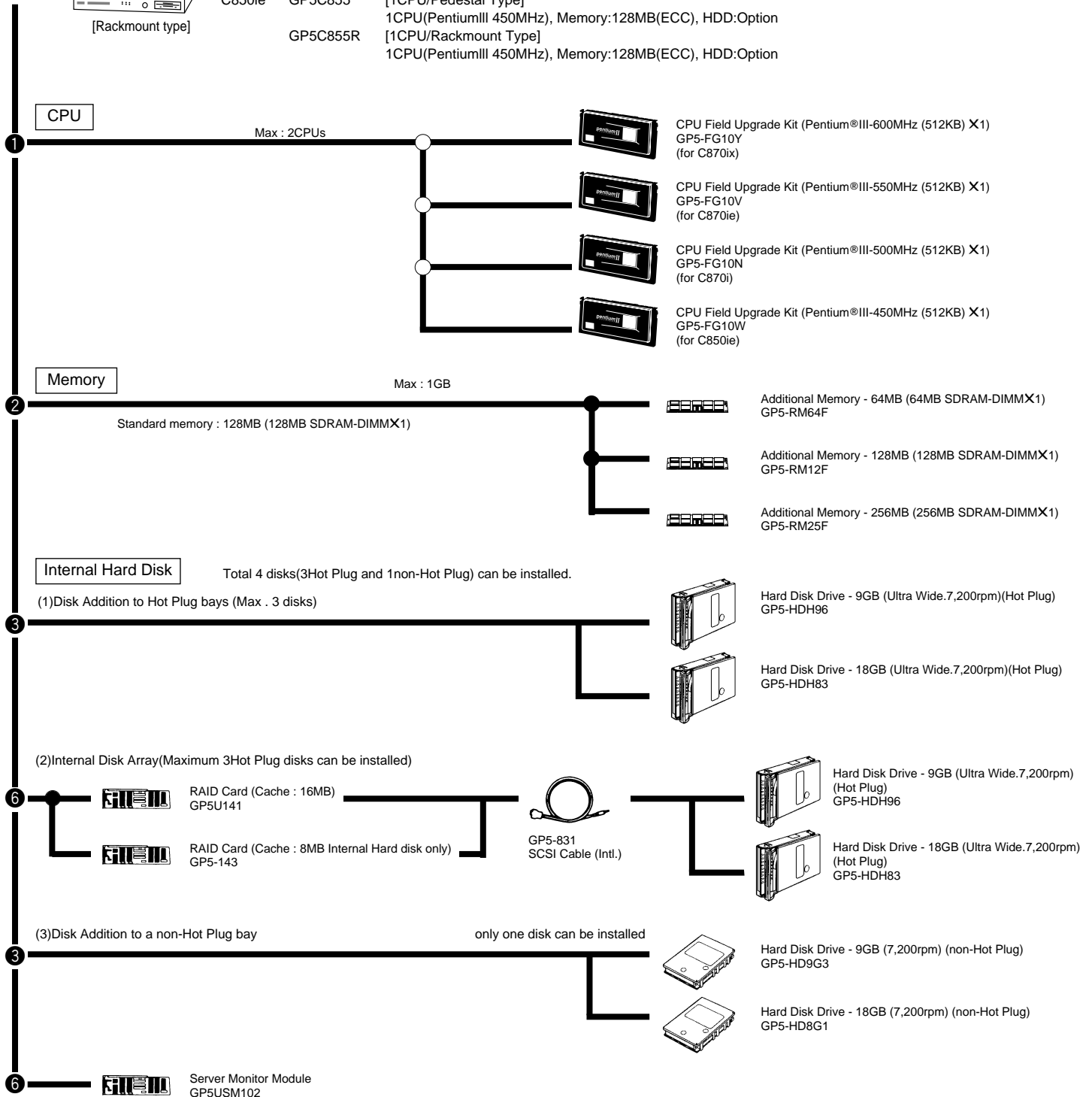
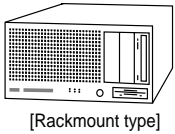

System Configuration

teamserver C300 series

teamserver C300 series



CPU: Pentium®III (600MHz/550MHz/500MHz)x 1, Cache (L1+L2) : 32KB+512KB, CD-ROM, On board LAN (Std.)
 Internal Hard disk bay: 4bays (use one 5" bay : non-hot-plug), Servervisor/ Intel LANDesk® Server Manager, ServerWizard

C370ix	GP5C379	[1CPU/Pedestal Type] 1CPU(PentiumIII 600MHz), Memory:128MB(ECC), HDD:Option
C370ie	GP5C378	[1CPU/Pedestal Type] 1CPU(PentiumIII 550MHz), Memory:128MB(ECC), HDD:Option
C370i	GP5C377	[1CPU/Pedestal Type] 1CPU(PentiumIII 500MHz), Memory:128MB(ECC), HDD:Option

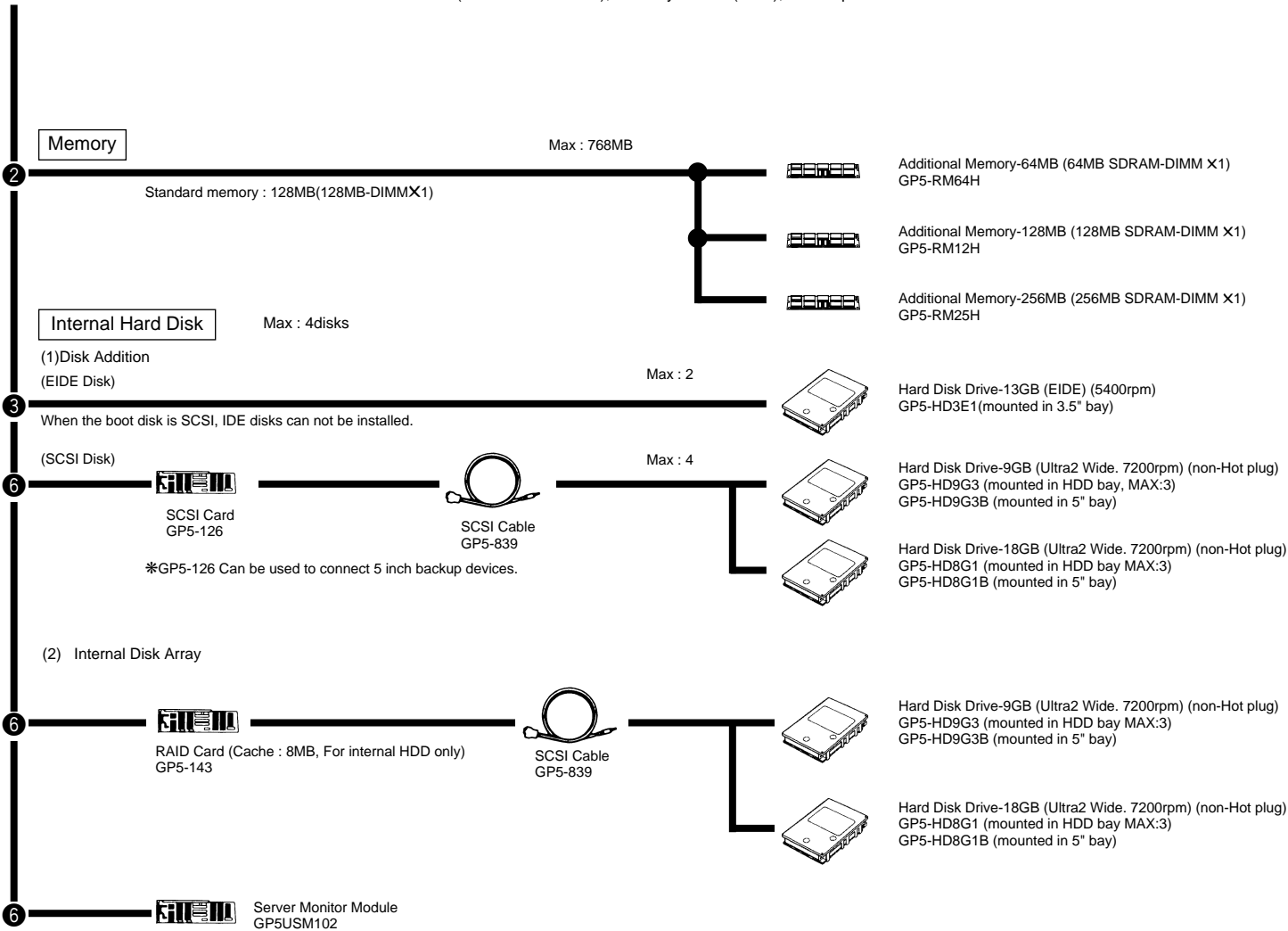

System Configuration

teamserver C350ie

teamserver C350ie



CPU: Pentium®III (450MHz) x 1, Cache (L1+L2) : 32KB+512KB, CD-ROM, LAN Card (Std.)
Internal Hard disk bay: 4bays (non-hot-plug), Servervisor, Intel LANDesk® Server Manager, System Walker, ServerWizard

C350ie GP5C355 [1CPU/Pedestal Type]
1CPU(PentiumIII 450MHz), Memory:64MB(ECC), HDD:Option

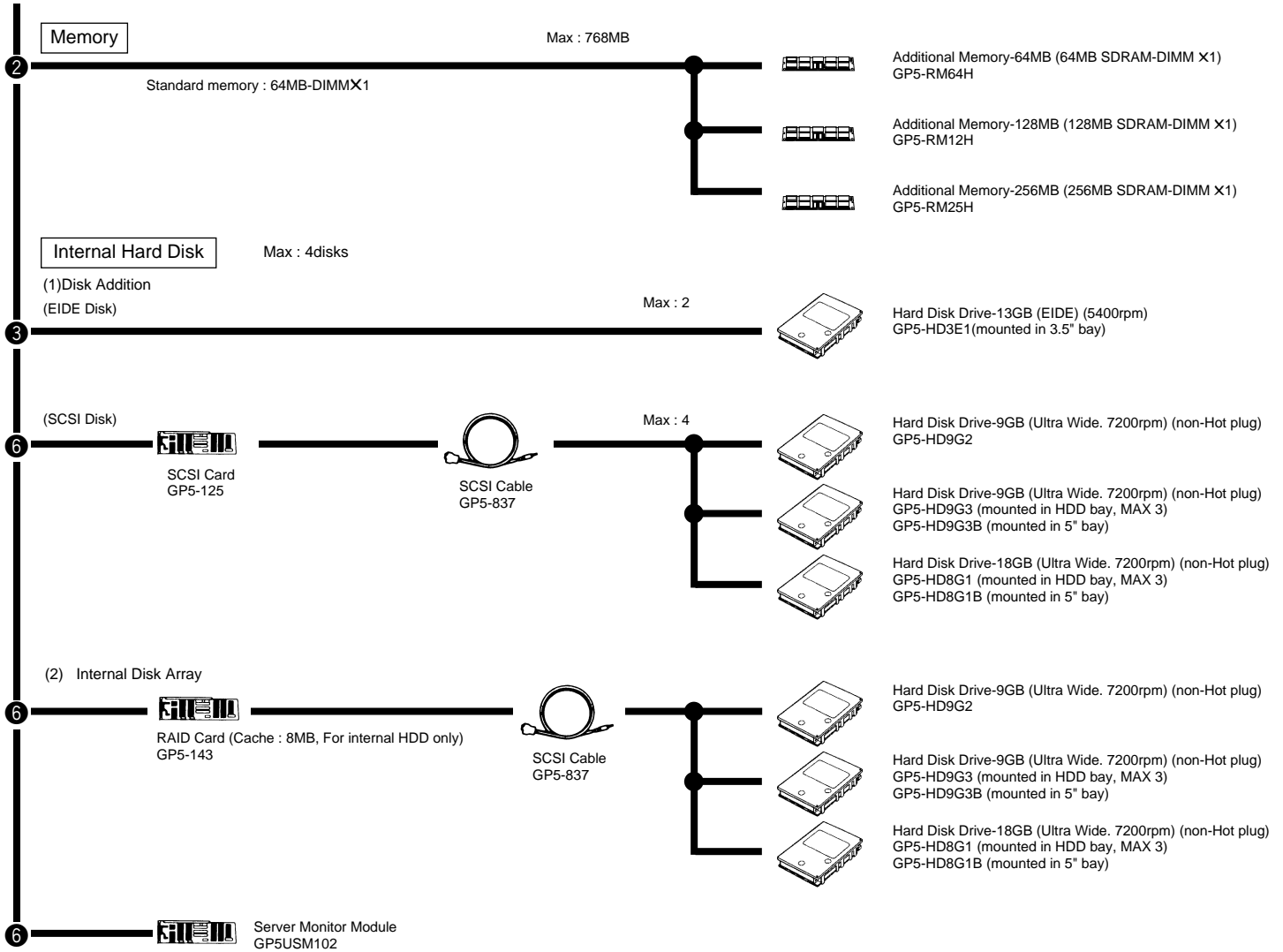

Network Cards

teamserver

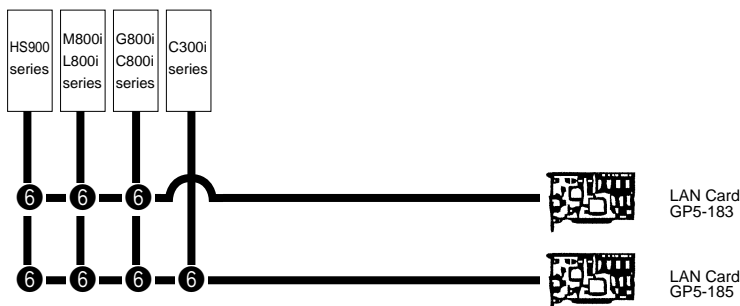
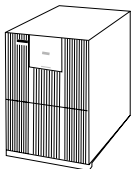

System Configuration

teamserver Internal Devices

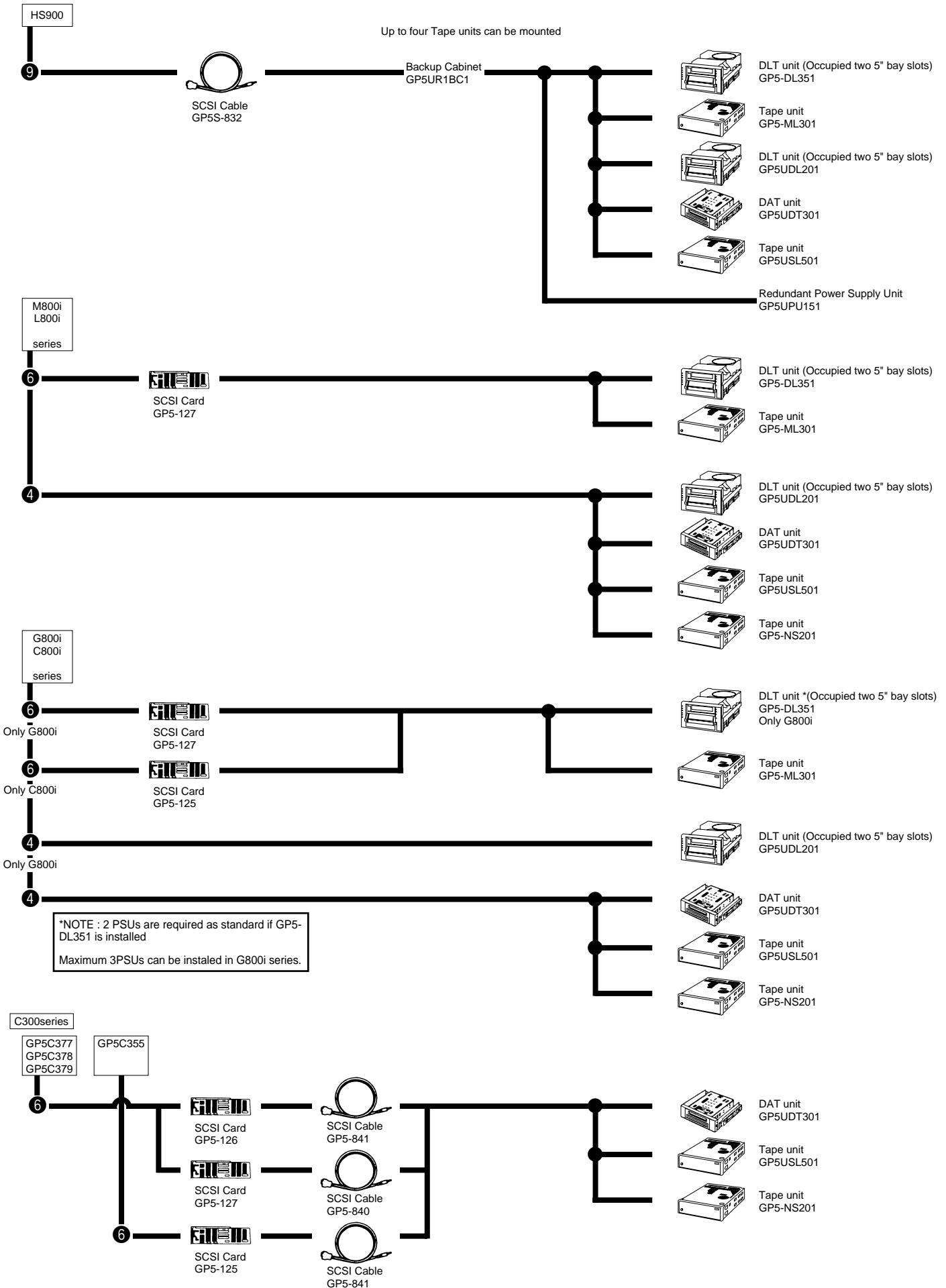

System Configuration

teamserver External Devices

(Pedestal only)

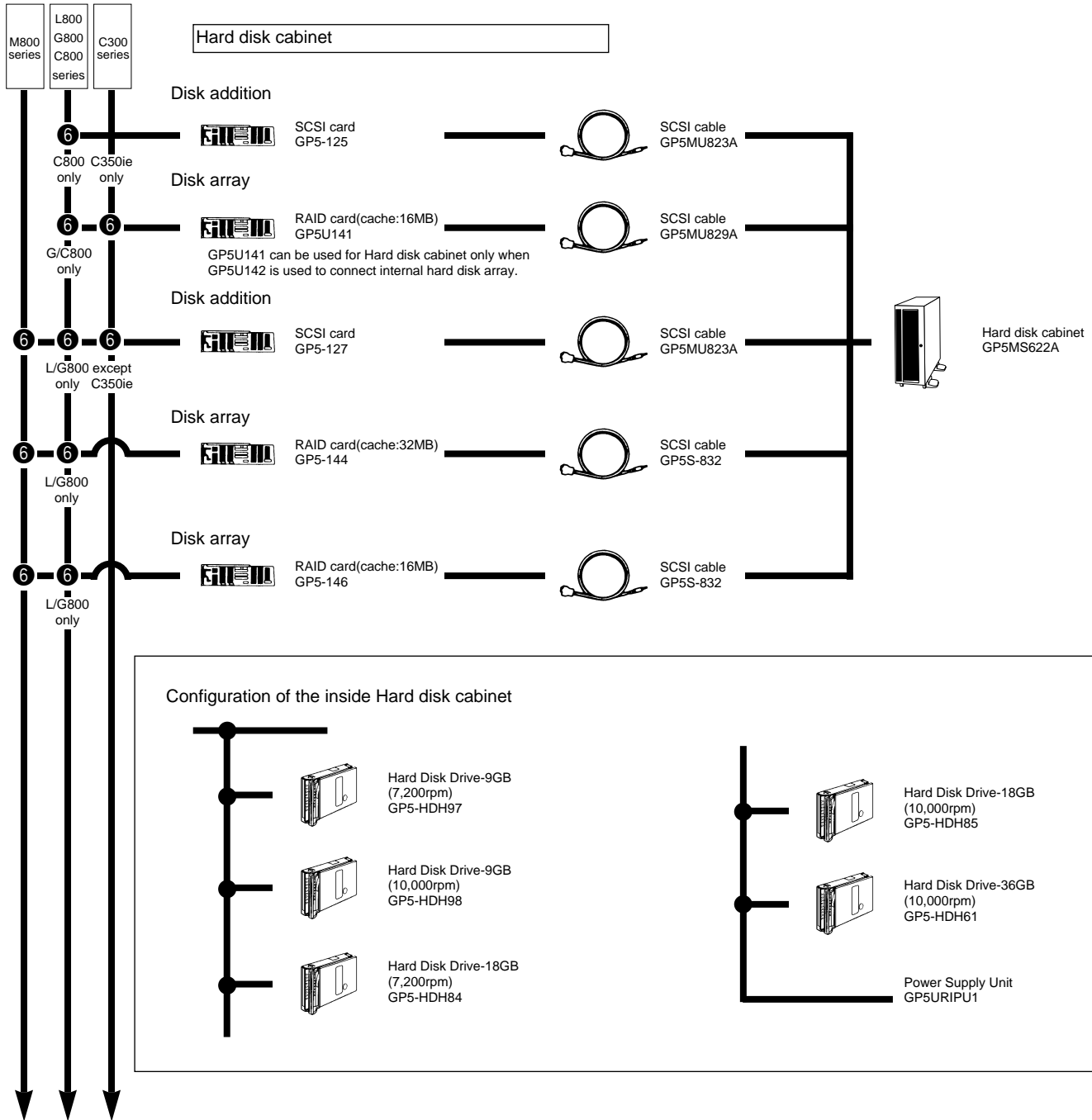

System Configuration

teamserver Rackmount

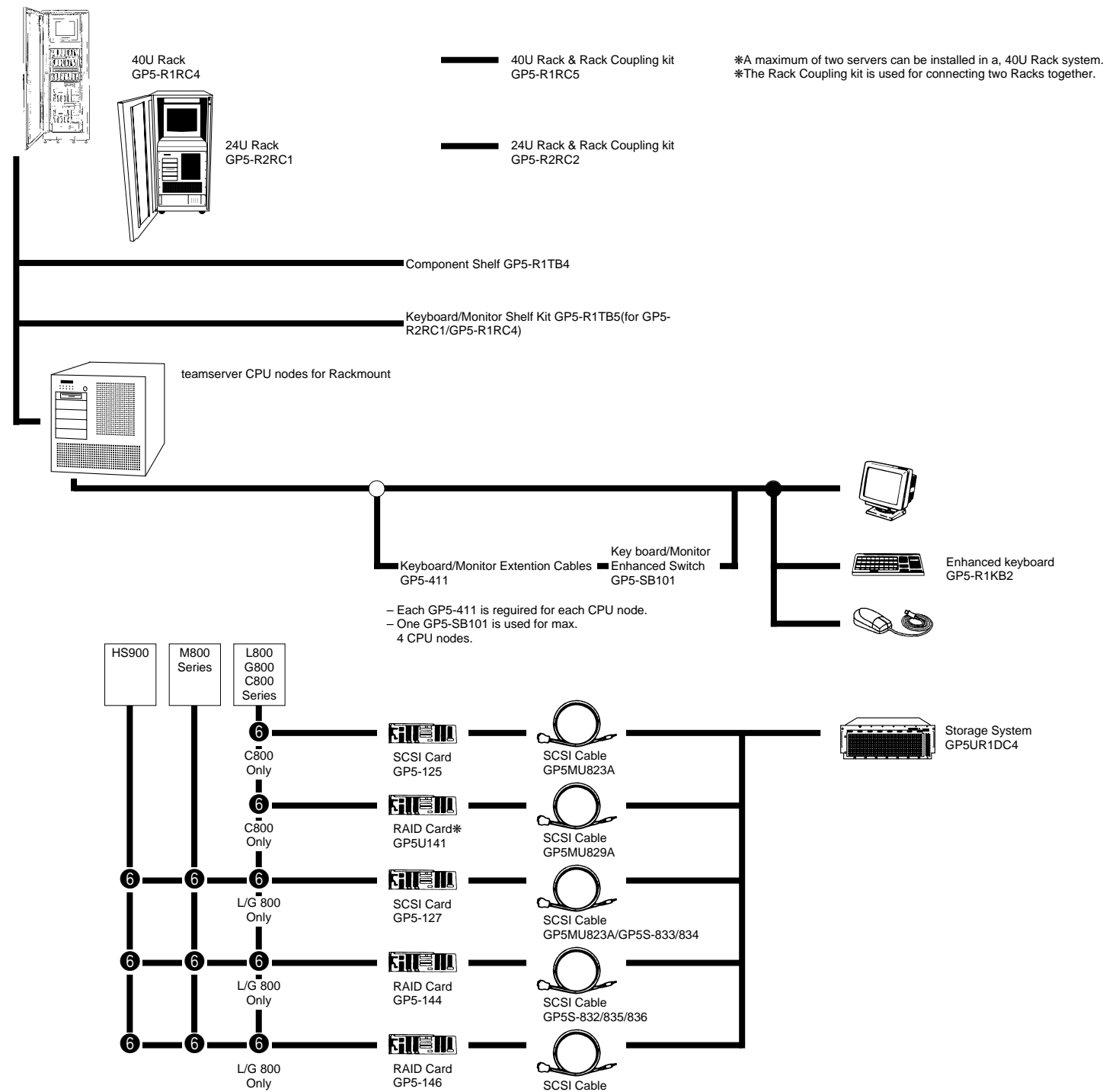

*GP5U141 can be used for Hard disk cabinet only when GP5U142 is used to connect internal hard disk array.

[Inside of Storage System]

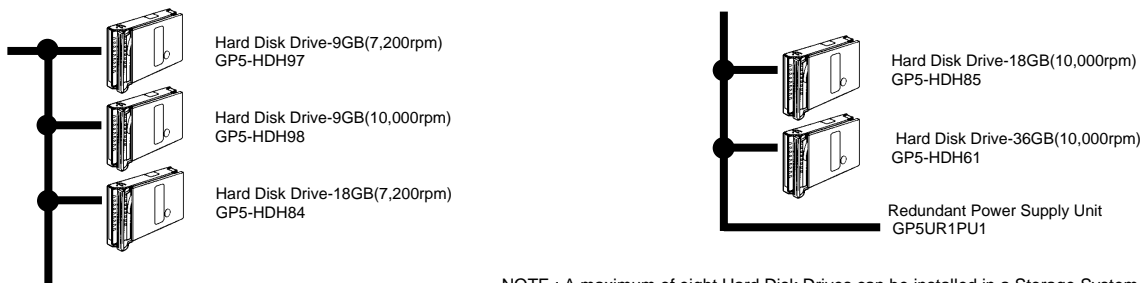

NOTE : A maximum of eight Hard Disk Drives can be installed in a Storage System. In a RAID configuration, a physical pack must be comprised of the same type of Hard disks.

teamserver Hardware

Product	Product ID	Remarks
teamserver HS900 (Rackmount) (End Nov 1999)	GP5T9A32R	Pentium III Xeon 550MHz with 2MB Cache (x2, up to 8CPUs) , 1GB (128MB SDRAM-DIMM x8) SDRAM-DIMM with ECC, (32GB maximum) 32xCD-ROM, FDD, 2x Ultra2 Wide Onboard SCSI and 2ch LVD array controller card, 100Base-TX/10Base-T LAN Card 2Internal HDD bays (Ultra2wide SCSI/Hot plug), 64bit(66MHz)Hot-plug PCIx4, 64bit(33MHz)Hot-plug PCIx6, Wakeup on LAN Hot plug-Redundant PSU/Fan, Servervisor/LANDesk Server Manager, ServerWizard * Windows NT4.0 only supports up to 4CPUs and 4GB Memory, for more than that use Windows NT 4.0E.E
teamserver HS900 (Rackmount) (End Nov 1999)	GP5T9A22R	Pentium III Xeon 550MHz with 1MB Cache (x2, up to 8CPUs) , 1GB (128MB SDRAM-DIMM x8) SDRAM-DIMM with ECC, (32GB maximum) 32xCD-ROM, FDD, 2x Ultra2 Wide Onboard SCSI and 2ch LVD array controller card, 100Base-TX/10Base-T LAN Card 2Internal HDD bays (Ultra2wide SCSI/Hot plug), 64bit(66MHz)Hot-plug PCIx4, 64bit(33MHz)Hot-plug PCIx6, Wakeup on LAN Hot plug-Redundant PSU/Fan, Servervisor/LANDesk Server Manager, ServerWizard * Windows NT4.0 only supports up to 4CPUs and 4GB Memory, for more than that use Windows NT 4.0E.E
teamserver M890ie (End Nov 1999)	GP5M895AL	Pentium III Xeon 550MHz with 2MB Cache (x1, up to 4CPUs) , 256MB EDO-DIMM with ECC.50ns (8GB maximum) 32xCD-ROM, FDD, Fast narrow Onboard SCSI, 100Base-TX/10Base-T LAN Card 6Internal HDD bays (Ultra2wide SCSI/Hot plug) - 14bays maximum : Intl. HDD(6)+GP5UR1DC4,PCI64bitx5, PCI32bitx5, ISA/PCI32bitx1, Hot plug PSU, Hot plug Fan, Servervisor/LANDesk Server Manager, ServerWizard * Windows NT4.0 only supports up to 4CPUs and 4GB Memory, for more than that use Windows NT 4.0E.E
teamserver M890ie (Rackmount) (End Nov 1999)	GP5M895BL	Pentium III Xeon 550MHz with 2MB Cache (x1, up to 4CPUs) , 256MB EDO-DIMM with ECC.50ns (8GB maximum) 32xCD-ROM, FDD, Fast narrow Onboard SCSI, 100Base-TX/10Base-T LAN Card 6Internal HDD bays (Ultra2wide SCSI/Hot plug) - 14bays maximum : Intl. HDD(6)+GP5UR1DC4,PCI64bitx5, PCI32bitx5, ISA/PCI32bitx1, Hot plug PSU, Hot plug Fan, Servervisor/LANDesk Server Manager, ServerWizard * Windows NT4.0 only supports up to 4CPUs and 4GB Memory, for more than that use Windows NT 4.0E.E
teamserver M880ie (End Nov 1999)	GP5M885AL	Pentium III Xeon 550MHz with 1MB Cache (x1, up to 4CPUs) , 256MB EDO-DIMM with ECC.50ns (8GB maximum) 32xCD-ROM, FDD, Fast narrow Onboard SCSI, 100Base-TX/10Base-T LAN Card 6Internal HDD bays (Ultra2wide SCSI/Hot plug) - 14bays maximum : Intl. HDD(6)+GP5UR1DC4,PCI64bitx5, PCI32bitx5, ISA/PCI32bitx1, Hot plug PSU, Hot plug Fan, Servervisor/LANDesk Server Manager, ServerWizard * Windows NT4.0 only supports up to 4CPUs and 4GB Memory, for more than that use Windows NT 4.0E.E
teamserver M880ie (Rackmount) (End Nov 1999)	GP5M885BL	Pentium III Xeon 550MHz with 1MB Cache (x1, up to 4CPUs) , 256MB EDO-DIMM with ECC.50ns (8GB maximum) 32xCD-ROM, FDD, Fast narrow Onboard SCSI, 100Base-TX/10Base-T LAN Card 6Internal HDD bays (Ultra2wide SCSI/Hot plug) - 14bays maximum : Intl. HDD(6)+GP5UR1DC4,PCI64bitx5, PCI32bitx5, ISA/PCI32bitx1, Hot plug PSU, Hot plug Fan, Servervisor/LANDesk Server Manager, ServerWizard * Windows NT4.0 only supports up to 4CPUs and 4GB Memory, for more than that use Windows NT 4.0E.E
teamserver L890ie (Mid Nov 1999)	GP5L895L	Pentium III Xeon 550MHz with 2MB Cache (x1, up to 4CPUs) , 256MB EDO-DIMM with ECC.50ns (4GB maximum) 24xCD-ROM,FDD, 2xUltra2 Wide/1xFast narrow Onboard SCSI, 100Base-TX/10Base-T LAN Card 8Internal HDD bays (Ultra2Wide SCSI/Hot plug), PCIx6, ISA/PCIx1, Wakeup on LAN Hot plug PSU,Hot plug Fan, Servervisor/LANDesk Server Manager, ServerWizard
teamserver L890ie (Rackmount) (Mid Nov 1999)	GP5L895LR	Pentium III Xeon 550MHz with 2MB Cache (x1, up to 4CPUs) , 256MB EDO-DIMM with ECC.50ns (4GB maximum) 24xCD-ROM,FDD, 2xUltra2 Wide/1xFast narrow Onboard SCSI, 100Base-TX/10Base-T LAN Card 8Internal HDD bays (Ultra2Wide SCSI/Hot plug), PCIx6, ISA/PCIx1, Wakeup on LAN Hot plug PSU,Hot plug Fan, Servervisor/LANDesk Server Manager, ServerWizard
teamserver L880ie (Mid Nov 1999)	GP5L885L	Pentium III Xeon 550MHz with 1MB Cache (x1, up to 4CPUs) , 256MB EDO-DIMM with ECC.50ns (4GB maximum) 24xCD-ROM,FDD, 2xUltra2 Wide/1xFast narrow Onboard SCSI, 100Base-TX/10Base-T LAN Card 8Internal HDD bays (Ultra2Wide SCSI/Hot plug), PCIx6, ISA/PCIx1, Wakeup on LAN Hot plug PSU,Hot plug Fan, Servervisor/LANDesk Server Manager, ServerWizard

teamserver Hardware

Product	Product ID	Remarks
teamserver L880ie (Rackmount) (Mid Nov 1999)	GP5L885LR	Pentium III Xeon 550MHz with 1MB Cache (x1, up to 4CPUs) , 256MB EDO-DIMM with ECC,50ns (4GB maximum) 24xCD-ROM,FDD, 2xUltra2 Wide/1xFast narrow Onboard SCSI, 100Base-TX/10Base-T 8Internal HDD bays (Ultra2Wide SCSI/Hot plug), PCIx6, ISA/PCIx1, Wakeup on LAN Hot plug PSU,Hot plug Fan, Servervisor/LANDesk Server Manager, ServerWizard
teamserver L870ie (Mid Nov 1999)	GP5L875L	Pentium III Xeon 550MHz with 512KB Cache (x1, up to 4CPUs) , 256MB EDO-DIMM with ECC,50ns (4GB maximum) 24xCD-ROM,FDD, 2xUltra2 Wide/1xFast narrow Onboard SCSI, 100Base-TX/10Base-T 8Internal HDD bays (Ultra2Wide SCSI/Hot plug), PCIx6, ISA/PCIx1, Wakeup on LAN Hot plug PSU,Hot plug Fan, Servervisor/LANDesk Server Manager, ServerWizard
teamserver L870ie (Rackmount) (Mid Nov 1999)	GP5L875LR	Pentium III Xeon 550MHz with 512KB Cache (x1, up to 4CPUs) , 256MB EDO-DIMM with ECC,50ns (4GB maximum) 24xCD-ROM,FDD, 2xUltra2 Wide/1xFast narrow Onboard SCSI, 100Base-TX/10Base-T 8Internal HDD bays (Ultra2Wide SCSI/Hot plug), PCIx6, ISA/PCIx1, Wakeup on LAN Hot plug PSU,Hot plug Fan, Servervisor/LANDesk Server Manager, ServerWizard
teamserver G870ix (Mid Nov 1999)	GP5G879L	Pentium III 600MHz with 512KB Cache (x1, up to 2CPUs) , 256MB SDRAM (Single DIMM with ECC,2GB maximum) 32xCD-ROM, FDD, 2xUltra2 Wide/1xFast narrow Onboard SCSI, 100Base-TX/10Base-T Onboard LAN 8Internal HDD bays (Ultra2Wide SCSI/Hot plug), PCIx4, ISA/PCIx1, ISAx1, Hot plug PSU,Hot plug Fan, Wakeup on LAN, Servervisor/LANDesk Server Manager, ServerWizard
teamserver G870ix (Rackmount) (Mid Nov 1999)	GP5G879LR	Pentium III 600MHz with 512KB Cache (x1, up to 2CPUs) , 256MB SDRAM (Single DIMM with ECC,2GB maximum) 32xCD-ROM, FDD, 2xUltra2 Wide/1xFast narrow Onboard SCSI, 100Base-TX/10Base-T Onboard LAN 8Internal HDD bays (Ultra2Wide SCSI/Hot plug) - 40bays maximum : Intl. HDD(8)+GP5UR1DC4x4, PCIx4, ISA/PCIx1, ISAx1 Hot plug PSU,Hot plug Fan, Wakeup on LAN, Servervisor/LANDesk Server Manager, ServerWizard
teamserver G870ie (Mid Nov 1999)	GP5G878L	Pentium III 550MHz with 512KB Cache (x1, up to 2CPUs) , 256MB SDRAM (Single DIMM with ECC,2GB maximum) 32xCD-ROM, FDD, 2xUltra2 Wide/1xFast narrow Onboard SCSI, 100Base-TX/10Base-T Onboard LAN 8Internal HDD bays (Ultra2Wide SCSI/Hot plug), PCIx4, ISA/PCIx1, ISAx1, Hot plug PSU,Hot plug Fan, Wakeup on LAN, Servervisor/LANDesk Server Manager, ServerWizard
teamserver G870ie (Rackmount) (Mid Nov 1999)	GP5G878LR	Pentium III 550MHz with 512KB Cache (x1, up to 2CPUs) , 256MB SDRAM (Single DIMM with ECC,2GB maximum) 32xCD-ROM, FDD, 2xUltra2 Wide/1xFast narrow Onboard SCSI, 100Base-TX/10Base-T Onboard LAN 8Internal HDD bays (Ultra2Wide SCSI/Hot plug) - 40bays maximum : Intl. HDD(8)+GP5UR1DC4x4, PCIx4, ISA/PCIx1, ISAx1 Hot plug PSU,Hot plug Fan, Wakeup on LAN, Servervisor/LANDesk Server Manager, ServerWizard
teamserver G870i (Mid Nov 1999)	GP5G877L	Pentium III 500MHz with 512KB Cache (x1, up to 2CPUs) , 256MB SDRAM (Single DIMM with ECC,2GB maximum) 32xCD-ROM, FDD, 2xUltra2 Wide/1xFast narrow Onboard SCSI, 100Base-TX/10Base-T Onboard LAN 8Internal HDD bays (Ultra2Wide SCSI/Hot plug), PCIx4, ISA/PCIx1, ISAx1, Hot plug PSU,Hot plug Fan, Wakeup on LAN, Servervisor/LANDesk Server Manager, ServerWizard
teamserver G870i (Rackmount) (Mid Nov 1999)	GP5G877LR	Pentium III 500MHz with 512KB Cache (x1, up to 2CPUs) , 256MB SDRAM (Single DIMM with ECC,2GB maximum) 32xCD-ROM, FDD, 2xUltra2 Wide/1xFast narrow Onboard SCSI, 100Base-TX/10Base-T Onboard LAN 8Internal HDD bays (Ultra2Wide SCSI/Hot plug) - 40bays maximum : Intl. HDD(8)+GP5UR1DC4x4, PCIx4, ISA/PCIx1, ISAx1 Hot plug PSU,Hot plug Fan, Wakeup on LAN, Servervisor/LANDesk Server Manager, ServerWizard
teamserver C870ix (Mid Nov 1999)	GP5C876	Pentium III 600MHz with 512KB Cache (x1, up to 2CPUs) , 128MB SDRAM (Single DIMM with ECC,1GB maximum) 32xCD-ROM, FDD, 1xUltrawide/1xFast narrow Onboard SCSI, 100Base-TX/10Base-T Onboard LAN 4Internal HDD bays (Ultra Wide SCSI/3xHot plug), PCIx3, ISAx2, Wakeup on LAN Servervisor/LANDesk Server Manager, ServerWizard
teamserver C870ix (Rackmount) (Mid Nov 1999)	GP5C876R	Pentium III 600MHz with 512KB Cache (x1, up to 2CPUs) , 128MB SDRAM (Single DIMM with ECC,1GB maximum) 32xCD-ROM, FDD, 1xUltrawide/1xFast narrow Onboard SCSI, 100Base-TX/10Base-T Onboard LAN 4Internal HDD bays (Ultra Wide SCSI/3xHot plug) - 36bays maximum : Intl. HDD(4)+GP5UR1DC4x4, PCIx3, ISAx2, Wakeup on LAN Servervisor/LANDesk Server Manager, ServerWizard

teamserver Hardware

Product	Product ID	Remarks
teamserver C870ie	GP5C875	Pentium III 550MHz with 512KB Cache (x1, up to 2CPUs) , 128MB SDRAM (Single DIMM with ECC,1GB maximum) 32xCD-ROM, FDD, 1xUltrawide/1xFast narrow SCSI is on board, 100Base-TX/10Base-T Onboard LAN 4Internal HDD bays (Ultra Wide SCSI/3xHot plug), PCIx3, ISAx2, Wakeup on LAN Servervisor/LANDesk Server Manager, ServerWizard
teamserver C870ie (Rackmount)	GP5C875R	Pentium III 550MHz with 512KB Cache (x1, up to 2CPUs) , 128MB SDRAM (Single DIMM with ECC,1GB maximum) 32xCD-ROM, FDD, 1xUltrawide/1xFast narrow SCSI is on board, 100Base-TX/10Base-T Onboard LAN 4Internal HDD bays (Ultra Wide SCSI/3xHot plug) - 36bays maximum : Intl. HDD(4)+GP5UR1DC4x4, PCIx3, ISAx2, Wakeup on LAN Servervisor/LANDesk Server Manager, ServerWizard
teamserver C870i	GP5C871	Pentium III 500MHz with 512KB Cache (x1, up to 2CPUs) , 128MB SDRAM (Single DIMM with ECC,1GB maximum) 32xCD-ROM, FDD, 1xUltrawide/1xFast narrow SCSI is on board, 100Base-TX/10Base-T Onboard LAN 4Internal HDD bays (Ultra Wide SCSI/3xHot plug), PCIx3, ISAx2, Wakeup on LAN Servervisor/LANDesk Server Manager, ServerWizard
teamserver C870i (Rackmount)	GP5C871R	Pentium III 500MHz with 512KB Cache (x1, up to 2CPUs) , 128MB SDRAM (Single DIMM with ECC,1GB maximum) 32xCD-ROM, FDD, 1xUltrawide/1xFast narrow SCSI is on board, 100Base-TX/10Base-T Onboard LAN 4Internal HDD bays (Ultra Wide SCSI/3xHot plug) - 36bays maximum : Intl. HDD(4)+GP5UR1DC4x4, PCIx3, ISAx2, Wakeup on LAN Servervisor/LANDesk Server Manager, ServerWizard
teamserver C850ie	GP5C855	Pentium III 450MHz with 512KB Cache (x1, up to 2CPUs) , 128MB SDRAM (Single DIMM with ECC,1GB maximum) 32xCD-ROM, FDD, 1xUltrawide/1xFast narrow SCSI is on board, 100Base-TX/10Base-T Onboard LAN 4Internal HDD bays (Ultra Wide SCSI/3xHot plug), PCIx3, ISAx2, Wakeup on LAN Servervisor/LANDesk Server Manager, ServerWizard
teamserver C850ie (Rackmount)	GP5C855R	Pentium III 450MHz with 512KB Cache (x1, up to 2CPUs) , 128MB SDRAM (Single DIMM with ECC,1GB maximum) 32xCD-ROM, FDD, 1xUltrawide/1xFast narrow SCSI is on board, 100Base-TX/10Base-T Onboard LAN 4Internal HDD bays (Ultra Wide SCSI/3xHot plug) - 36bays maximum : Intl. HDD(4)+GP5UR1DC4x4, PCIx3, ISAx2, Wakeup on LAN Servervisor/LANDesk Server Manager, ServerWizard
teamserver C370ix (Mid Nov 1999)	GP5C379	Pentium III 600MHz with 512KB Cache (x1),128MB Unbuffered SDRAM (Single DIMM with ECC,768MB maximum) 32xCD-ROM, FDD, 100Base-TX/10Base-T PCIx4,ISAx1, 3(4:use 5"bay)Internal HDD bays (Ultra2 Wide SCSI /EIDE, non-Hot plug), Wakeup on LAN Servervisor/LANDesk Server Manager, ServerWizard
teamserver C370ie (Mid Nov 1999)	GP5C378	Pentium III 550MHz with 512KB Cache (x1),128MB Unbuffered SDRAM (Single DIMM with ECC,768MB maximum) 32xCD-ROM, FDD, 100Base-TX/10Base-T PCIx4,ISAx1, 3(4:use 5"bay)Internal HDD bays (Ultra2 Wide SCSI /EIDE, non-Hot plug), Wakeup on LAN Servervisor/LANDesk Server Manager, ServerWizard
teamserver C370i (Mid Nov 1999)	GP5C377	Pentium III 500MHz with 512KB Cache (x1),128MB Unbuffered SDRAM (Single DIMM with ECC,768MB maximum) 32xCD-ROM, FDD, 100Base-TX/10Base-T PCIx4,ISAx1, 3(4:use 5"bay)Internal HDD bays (Ultra2 Wide SCSI /EIDE, non-Hot plug), Wakeup on LAN Servervisor/LANDesk Server Manager, ServerWizard
teamserver C350ie	GP5C355	Pentium III 450MHz with 512KB Cache (x1),64MB Unbuffered SDRAM (Single DIMM with ECC,768MB maximum) 32xCD-ROM, FDD, 100Base-TX/10Base-T PCIx4,ISAx1, 3(4:use 5"bay)Internal HDD bays (Ultra Wide SCSI /EIDE, non-Hot plug), Wakeup on LAN Servervisor/LANDesk Server Manager, ServerWizard

teamserver Hardware

Product	Product ID (Overseas inc.Korea)	HS900		M800i		L800i		G800i		C800i		C300i		Remarks						
		GP5T9A32R	GP5T9A22R	GP5M895L	GP5M885L	GP5L895L	GP5L885L	GP5L875L	GP5G879L	GP5G878L	GP5G877L	GP5C876	GP5C875		GP5C871	GP5C855	GP5C379	GP5C378	GP5C377	GP5C355
CPU Field Upgrade Kit	GP5-FG203T	■																		P-III Xeon(550MHz)/32KB+2Mbcachex1,Placed on motherboard Includes one CPU, For HS900
CPU Field Upgrade Kit	GP5-FG202T	■																		P-III Xeon(550MHz)/32KB+1Mbcachex1,Placed on motherboard Includes one CPU, For HS900
CPU Field Upgrade Kit	GP5-FG203			■	■															P-III Xeon(550MHz)/32KB+2Mbcachex1,Placed on motherboard Includes one CPU and dedicated power supply module (VRM)
CPU Field Upgrade Kit	GP5-FG202				■	■														P-III Xeon(550MHz)/32KB+1Mbcachex1,Placed on motherboard Includes one CPU and a dedicated power supply module (VRM)
CPU Field Upgrade Kit	GP5-FG201						■													P-III Xeon(550MHz)/32KB+512KBcachex1,Placed on motherboard Includes one CPU and a dedicated power supply module (VRM)
CPU Field Upgrade Kit	GP5-FG10Y							■		■										P-III(600MHz)/32KB+512KB, for G870ix/C870ix Do not mix with other processor speed
CPU Field Upgrade Kit	GP5-FG10V								■		■									P-III(550MHz)/32KB+512KB, for G870ie/C870ie Do not mix with other processor speed
CPU Field Upgrade Kit	GP5-FG10N								■		■									P-III(500MHz)/32KB+512KBx1, for G870i/C870i Do not mix with other processor speed
CPU Field Upgrade Kit	GP5-FG10W											■								P-III(450MHz)/32KB+512KBx1, for G850ie/C850ie Do not mix with other processor speed
Additional Memory 2GB (End Feb 00)	GP5-RM2J	■	■																	SDRAM-DIMM 1024MBx2 (Registered 100MHz)
Additional Memory 1GB (End Jan 00)	GP5-RM1J	■	■																	SDRAM-DIMM 512MBx2 (Registered 100MHz)
Additional Memory 512MB (End Jan 00)	GP5-RM51J	■	■																	SDRAM-DIMM 256MBx2 (Registered 100MHz)
Additional Memory 256MB	GP5-RM25J	■	■																	SDRAM-DIMM 128MBx2 (Registered 100MHz)
Additional Memory Board	GP5-RB201	■	■																	Additional memory board for mounting more than 16GB memory
Additional Memory 1GB	GP5-RM1G			■	■	■	■	■												EDO-DIMM(Buffered;50ns)256MBx4
Additional Memory 512MB	GP5-RM51G			■	■	■	■	■												EDO-DIMM(Buffered;50ns)128MBx4
Additional Memory 256MB	GP5-RM25G			■	■	■	■	■												EDO-DIMM(Buffered;50ns)64MBx4
Additional Memory 128MB	GP5-RM12G					■	■	■												EDO-DIMM(Buffered;50ns)32MBx4
Additional Memory 512MB	GP5-RM51F							■	■	■										SDRAM-DIMM 512MBx1 (Registered 100MHz)
Additional Memory 256MB	GP5-RM25F							■	■	■	■	■	■							SDRAM-DIMM 256MBx1 (Registered 100MHz)
Additional Memory 128MB	GP5-RM12F							■	■	■	■	■	■							SDRAM-DIMM 128MBx1 (Registered 100MHz)
Additional Memory 64MB	GP5-RM64F							■	■	■	■	■	■							SDRAM-DIMM 64MBx1 (Registered 100MHz)
Additional Memory 256MB	GP5-RM25H												■	■	■	■				Unbuffered SDRAM-DIMM 256MBx1
Additional Memory 128MB	GP5-RM12H												■	■	■	■				Unbuffered SDRAM-DIMM 128MBx1
Additional Memory 64MB	GP5-RM64H												■	■	■	■				Unbuffered SDRAM-DIMM 64MBx1
Hard Disk Drive-36GB	GP5-HDH61T	■	■																	36.4GB,Ultra2wide SCSI,10000rpm,SCA2 80pin(SE),Hotplug for HS900
Hard Disk Drive-18GB	GP5-HDH85T	■	■																	18.2GB,Ultra2wide SCSI,10000rpm,SCA2 80pin(SE),Hotplug for HS900
Hard Disk Drive-9GB	GP5-HDH98T	■	■																	9.1GB,Ultra2wide SCSI,10000rpm,SCA2 80pin(SE),Hotplug for HS900
Hard Disk Drive-36GB	GP5-HDH61			■	■	■	■	■												36.4GB,Ultra2wide SCSI,10000rpm,SCA2 80pin(SE),Hotplug for M8xxi,L8xxi, Storage System(GP5UR1DC4), Hard Disk Cabinet(GP5MS622A)
Hard Disk Drive-18GB	GP5-HDH85			■	■	■	■	■												18.2GB,Ultra2wide SCSI,10000rpm,SCA2 80pin(SE),Hotplug for M8xxi,L8xxi, Storage System(GP5UR1DC4), Hard Disk Cabinet(GP5MS622A)
Hard Disk Drive-9GB	GP5-HDH98			■	■	■	■	■												9.1GB,Ultra2wide SCSI,10000rpm,SCA2 80pin(SE),Hotplug for M8xxi,L8xxi, Storage System(GP5UR1DC4), Hard Disk Cabinet(GP5MS622A)
Hard Disk Drive-18GB	GP5-HDH84			■	■	■	■	■												18.2GB,Ultra2wide SCSI,7200rpm,SCA2 80pin(SE),Hotplug for M8xxi,L8xxi, Storage System(GP5UR1DC4), Hard Disk Cabinet(GP5MS622A)
Hard Disk Drive-9GB	GP5-HDH97			■	■	■	■	■												9.1GB,Ultra2wide SCSI,7200rpm,SCA2 80pin(SE),Hotplug for M8xxi,L8xxi, Storage System(GP5UR1DC4), Hard Disk Cabinet(GP5MS622A)

teamserver Hardware

Product	Product ID (Overseas inc. Korea)	HS900	M800i	L800i	G800i	C800i				C300i			Remarks						
		GP5T9A32R	GP5T9A22R	GP5M885L	GP5M885L	GP5L885L	GP5L875L	GP5G879L	GP5G878L	GP5G877L	GP5C876	GP5C875		GP5C871	GP5C855	GP5C379	GP5C378	GP5C377	GP5C355
Hard Disk Drive-18GB	GP5-HDH83							■	■	■	■	■	■						18.2GB,Ultra2wide SCSI,7200rpm,SCA2 80pin(SE),Hotplug, For G8xxi,C8xxi
Hard Disk Drive-9GB	GP5-HDH96							■	■	■	■	■	■						9.1GB,Ultra2wide SCSI,7200rpm,SCA2 80pin(SE),Hotplug, For G8xxi, C8xxi
Hard Disk Drive-9GB	GP5-HDH92												■						9.1GB,Ultra Wide SCSI,7200rpm,SCA2 80pin(SE),Hotplug, Additional disk for GP5C800-875
Hard Disk Drive-4GB	GP5-HDH461												■						4.3GB,Ultra2 Wide SCSI,7200rpm,SCA2 80pin(SE),Hotplug Additional disk for GP5C800-875/GP5G810-876L
Hard Disk Drive-4GB	GP5-HDH44												■						4.3GB,Ultra Wide SCSI,7200rpm,SCA2 80pin(SE),Hotplug, Additional disk for GP5C800-875
Hard Disk Drive-18GB	GP5-HD8G1										■	■	■	■	■	■	■	■	18.2GB,Ultra2 Wide SCSI,7200rpm,SE,68pin, Non Hotplug for C8xxi(Mounted in Non Hotplug bay), C3xxi(Mounted in Non Hotplug 3.5"Bay)
Hard Disk Drive-9GB	GP5-HD9G3										■	■	■	■	■	■	■	■	9.1GB,Ultra2 Wide SCSI,7200rpm,SE,68pin, Non Hotplug for C8xxi(Mounted in Non Hotplug bay), C3xxi(Mounted in Non Hotplug 3.5"Bay)
Hard Disk Drive-9GB	GP5-HD9G2												■				■		9.1GB,Ultra Wide SCSI,7200rpm,SE,68pin, Non Hotplug Additional disk for GP5C300-375/GP5C800-C875
Hard Disk Drive-4GB	GP5-HD4G51												■				■		4.3GB,Ultra2 Wide SCSI,7200rpm,SE,68pin, Non Hotplug Additional disk for GP5C300-375/GP5C800-C875
Hard Disk Drive-4GB	GP5-HD4G5												■				■		4.3GB,Ultra Wide SCSI,7200rpm,SE,68pin, Non Hotplug Additional disk for GP5C300-375/GP5C800-C875
Hard Disk Drive-18GB	GP5-HD8G1B													■	■	■	■		18.2GB,Ultra2 Wide SCSI,7200rpm,SE,68pin, Non Hotplug for mounting in 5"bay of C3xxi
Hard Disk Drive-9GB	GP5-HD9G3B													■	■	■	■		9.1GB,Ultra2 Wide SCSI,7200rpm,SE,68pin, Non Hotplug for mounting in 5"bay of C3xxi
Hard Disk Drive-4GB	GP5-HD4G5B																■		4.3GB,Ultra2 Wide SCSI,7200rpm,SE,68pin, Non Hotplug Additional disk for mounting in 5"bay of GP5C300-C375
Hard Disk Drive-13GB	GP5-HD3E1														■	■	■	■	EIDE,5400rpm, 13GB, for C3xxi
DAT unit (DDS-3)	GP5UDT301	■	■	■	■	■	■	■	■	■	■	■	■	■	■	■	■	■	DDS-3 (12-24GB) Helical scan device back up 12GB (24GB average when compressed) Effective transfer speed is 1MB/s (not compressed)When connecting to C300i, SCSI Card (GP5-125,126/127) and SCSI Cable (GP5-841/840) is required, Please order cartridge and cleaning cartridge separately.
Tape unit (SLR5)	GP5USL501	■	■	■	■	■	■	■	■	■	■	■	■	■	■	■	■	■	SLR-5 (4-8GB) Single-channel linear recording system, 4GB (8GB average when compressed) Effective transfer speed is 380KB/s (not compressed)Data format: QIC-4GB, QIC-2GB, When connecting to C300i, SCSI Card (GP5-125,126/127) and SCSI Cable (GP5-841/840) is required, Please order cartridge and cleaning cartridge separately.
DLT unit	GP5UDL201	■	■	■	■	■	■	■	■	■	■	■	■	■	■	■	■	■	DLT4000SE narrow (20-40GB) Linear scan device back up 20GB (40GB average when compressed) high-speed transfer up to 1.5MB/s (not compressed)Shipped with one data cartridge and one cleaning cartridge.
DLT unit	GP5-DL351	■	■	■	■	■	■	■	■	■	■	■	■	■	■	■	■	■	DLT7000SE wide (35-70GB) Linear scan device back up 35GB (70GB average when compressed) high-speed transfer up to 5.0MB/s (not compressed)Shipped with one data cartridge, one cleaning cartridge and one internal SCSI Cable (with terminal resistor added). Two 5"bays are required and occupied. When mounting for G800i, additional PSU is required
Tape unit (MLR-3)	GP5-ML301	■	■	■	■	■	■	■	■	■	■	■	■	■	■	■	■	■	MLR-3 (20-40GB) Multi-channel linear recording system, 25GB (50GB average when compressed) and high-speed transfer - up to 2.0MB/s (not compressed)Data format: MLR3-25GB, SCSI Card is required to connect(Please refer to PXX), Shipped with one data cartridge and one cleaning cartridge.
TRAVAN NS unit (NS-20)	GP5-NS201	■	■	■	■	■	■	■	■	■	■	■	■	■	■	■	■	■	TRAVAN NS-20 (10-20GB) Linear scan device back up 10GB (20GB average when compressed) and high-speed transfer - up to 1.0MB/s, Data format:QIC-3220-MC, When connecting to C300i, SCSI Card (GP5-125,126/127) and SCSI Cable (GP5-841/840) is required, Shipped with one data cartridge and one cleaning cartridge.
Backup Cabinet	GP5UR1BC1	■	■																5" bay node for Rackmount (3U) Up to four Tape units can be mounted, GP5UDL351/GP5-DL201/GP5UDT301/GP5USL501/GP5-ML301/GP5-NS201 are available, Redundant PSU (Opt.), SCSI Cable (GP5U832, GP5S823) is required
Redundant Power Supply Unit	GP5UPU131			■	■	■	■	■	■										Redundant PSU (450W)
Redundant Power Supply Unit	GP5UPU141		■	■															Redundant PSU (350W)

teamserver Hardware

Product	Product ID (Overseas inc.Korea)	HS900	M800i	L800i	G800i	C800i	C300i			Remarks										
		GP5T9A32R	GP5T9A22R	GP5M895L	GP5M885L	GP5L895L	GP5L885L	GP5L875L	GP5G879L		GP5G878L	GP5G877L	GP5C876	GP5C875	GP5C871	GP5C855	GP5C379	GP5C378	GP5C377	GP5C355
Redundant Power Supply Unit	GP5UPU151	■	■																	Redundant PSU (300W), For Backup Cabinet (GP5UR1BC1)
Redundant Power Supply Unit	GP5UR1PU1	■	■	R/P	R/P	R/P	R/P	R/P	R/P	R/P	R/P	R/P	R/P	R/P	R/P	■	■	■	■	Redundant PSU for GP5UR1DC4/GP5MS622A (350W)
Rackmount Pattern	GP5RMP	R	R	R	R	R	R	R	R	R	R	R	R	R						Rackmount pattern instruction
40U Rack	GP5-R1RC4	■	■	R	R	R	R	R	R	R	R	R	R	R						19" 40U Locker , Front door,rear door,side panel,earthquake proof board , blank panel is attached. Size(WxDxH)mm:600x900x2000 <Number of units required for installation> C8xxi:6U, G8xxi:7U, L8xxi:7U, M8xxi/ic:10U GP5UR1DC4: 4U Keyboard/Monitor Shelf: 9U(for installation 15"CRT),1U(for installation Keyboard) Component shelf: 5U CRT/KB switch: Mounted at side of CRT (occupies same U as CRT)
40U Rack&Rack Coupling Kit	GP5-R1RC5	■	■	R	R	R	R	R	R	R	R	R	R	R						19"40U Locker + connection metal fittings Front door,rear door,concatenation frame,blank panel is attached.
24U Rack	GP5-R2RC1	■	■	R	R	R	R	R	R	R	R	R	R	R						19" 24U Locker , Front door,rear door,side panel,earthquake proof board , blank panel is attached. Size(WxDxH)mm:600x900x1200 <Number of units required for installation> C8xxi:6U, G8xxi:7U, L8xxi:7U, M8xxi/ic:10U GP5UR1DC4: 4U Keyboard/Monitor Shelf: 9U(for installation 15"CRT),1U(for installation Keyboard) Component shelf: 5U CRT/KB switch: Mounted at side of CRT (occupies same U as CRT)
24U Rack&Rack Coupling Kit	GP5-R2RC2	■	■	R	R	R	R	R	R	R	R	R	R	R						19"24U Locker + connection metal fittings Front door,rear door,concatenation frame,blank panel is attached.
Component Shelf	GP5-R1TB4	■	■	R	R	R	R	R	R	R	R	R	R	R						Shelf to fit peripheral device into 40U Rack, Table size:400(W)x500(D)
Keyboard/Monitor Shelf Kit	GP5-R1TB5	■	■	R	R	R	R	R	R	R	R	R	R	R						For New Rack (as of Jul 1999: GP5-R2RC1/GP5-R1DC4) Used to store display unit (CRT), a keyboard (KB), and a mouse on a rack.
Keyboard/Monitor Enhanced Switch	GP5-SB101	■	■	R	R	R	R	R	R	R	R	R	R	R						Switch enables sharing of a set of CRT,keyboard,and mouse by two or more servers (up to four servers).
Keyboard/Monitor Extension Cables	GP5-411	■	■	R	R	R	R	R	R	R	R	R	R	R						CRT/KB cable , CRT calex1,KB/Mouse calex1 is attached
Enhanced Keyboard	GP5-R1KB2	■	■	R	R	R	R	R	R	R	R	R	R	R						87Key keyboard for Rackmountable type
Storage System	GP5UR1DC4	■	■	R	R	R	R	R	R	R	R	R	R	R						Hard Disk Node LVD/SE for Rack (4U) 8 Hot plug HDD Bays (up to 291.2GB: 36.4GBx8) Support Ultra2 Wide SCSI/Ultra Wide SCSI, Redundant FAN(Up to two Std.)/PSU(A GP5UR1PU1is standard equipment, up to two)
Hard Disk Cabinet	GP5MS622A			P	P	P	P	P	P	P	P	P	P	P	■	■	■	■		Hard Disk Cabinet LVD/SE for Pedestal 8 Hot plug HDD Bays (up to 291.2GB: 36.4GBx8) Support Ultra2 Wide SCSI/Ultra Wide SCSI, Redundant FAN(Up to two Std.)/PSU(A GP5UR1PU1is standard equipment, up to two)
SCSI Card	GP5-123	■	■	■	■	■	■	■	■	■										Ultrawide, differential-end, x1ch, SMART not supported, Up to 40MB/s of synchronous transfer support Connector: half-pitch 68pin for external SCSI device, half-pitch 50/68pin for internal SCSI device For connection with Disk Array devices * SCSI cable is required.
SCSI Card	GP5-125										■	■	■	■					■	Ultrawide, SE, x1ch, SMART supported, Up to 40MB/s of synchronous transfer support Connector: half-pitch 68pin for external SCSI device, half-pitch 50/68pin for internal SCSI device. For connection with internal and external SCSI devices *SCSI cable is required.
SCSI Card	GP5-126														■	■	■			Ultra2 Wide, LVD, x1ch, SMART supported, Up to 80MB/s of synchronous transfer support Connector: half-pitch 68pin and half-pitch 50/68pin. *SCSI cable is required
SCSI Card	GP5-127	■	■	■	■	■	■	■	■	■					■	■	■			Ultra2 Wide, LVD, x1ch, SMART supported, Up to 80MB/s of synchronous transfer support Connector: half-pitch 68pin for external SCSI device, half-pitch 50/68pin for internal SCSI device. For connection with internal OR external SCSI devices *SCSI cable is required
RAID Card	GP5U141								■	■	■	■	■	■						Raid card, Ultrawide SCSI, SE, x2ch, 16MB cache, RAID level 0,1,5 are supported For internal/external array configuration *SCSI cable(for array configuration use) is required
RAID Card	GP5U142								■	■	■									Raid card, Ultrawide SCSI, SE, x2ch, 4MB cache, RAID level 0,1,5 are supported For internal array configuration *SCSI cable(for array configuration use) is required
RAID Card	GP5-143										■	■	■	■	■	■	■	■	■	Raid card, Ultrawide SCSI, x2ch, 8MB cache, RAID level 0,1,5,6 are supported For internal array configuration *SCSI cable(for array configuration use) is required

* P : Pedestal, R : Rack

teamserver Hardware

Product	Product ID (Overseas inc.korea)	HS900	M800i	L800i	G800i	C800i	C300i	Remarks													
		GP5T9A32R	GP5T9A22R	GP5M895L	GP5M885L	GP5L895L	GP5L885L					GP5L875L	GP5G879L	GP5G878L	GP5G877L	GP5C876	GP5C875	GP5C871	GP5C855	GP5C379	GP5C378
RAID Card	GP5-144	■	■	■	■	■	■	■	■	■											Raid card, Ultra2 Wide SCSI, LVD, x3ch, 32MB cache, Battery Backup, RAID level 0,1,5,6 are supported For internal/external array configuration *SCSI cable(for array configuration use) is required
RAID Card	GP5-146	■	■	■	■	■	■	■	■	■											Raid card, Ultra2 Wide SCSI, LVD, x2ch, 16MB cache, Battery Backup, RAID level 0,1,5,6 are supported For internal/external array configuration *SCSI cable(for array configuration use) is required
SCSI Cable	GP5U831										■	■	■	■							Connection internal devices (0.7m) for C8xxi
SCSI Cable	GP5-837														■	■	■	■			Ultra Wide SCSI cable(68pin), Internal SCSI HDD connection with GP5U141in C3xxi
SCSI Cable	GP5-839														■	■	■				Ultra2 Wide SCSI cable (68pin), Internal SCSI HDD connection in GP5C377-379
SCSI Cable	GP5-840														■	■	■				Internal narrow SCSI cable for 5" Bay (50pin) for GP5-127 in GP5C377-379
SCSI Cable	GP5-841														■	■	■	■			Internal narrow SCSI cable for 5" Bay (50pin) for GP5-125/126 in C3xxi
SCSI Cable	GP5S-832	■	■	■	■	■	■	■	■	■											For connection GP5-144/146 to GP5UR1DC4/GP5MS622A (3m)
SCSI Cable	GP5S-833	■	■	■	■	■	■	■	■	■	■	■	■	■							For connection GP5-127 to GP5UR1DC4 (5m), Only for Rackmount
SCSI Cable	GP5S-834	■	■	■	■	■	■	■	■	■	■	■	■	■							For connection GP5-127 to GP5UR1DC4(10m), Only for Rackmount
SCSI Cable	GP5S-835	■	■	■	■	■	■	■	■	■	■	■	■	■							For connection GP5-144/146 to GP5UR1DC4(5m), Only for Rackmount
SCSI Cable	GP5S-836	■	■	■	■	■	■	■	■	■	■	■	■	■							For connection GP5-144/146 to GP5UR1DC4(10m), Only for Rackmount
SCSI Cable	GP5MU823A	■	■	■	■	■	■	■	■	■	■	■	■	■	■	■	■	■	■	■	SCSI-3(68pin)-SCSI-4(68pin), For connecting GP5-125/127 to GP5MS622A,GP5UR1DC4 (3.0m)
SCSI Cable	GP5MU829A	■	■	■	■	■	■	■	■	■	■	■	■	■	■	■	■	■	■	■	For connection between GP5U141 and GP5MS622A/GP5U141 to GP5UR1DC4 (2.0m)
SCSI Cable	GP5U832	■	■	■	■	■	■	■	■	■	■	■	■	■	■	■	■	■	■	■	SCSI Cable half68pin-Full50pin (1.0m)
SCSI Cable	GP5U833	■	■	■	■	■	■	■	■	■	■	■	■	■	■	■	■	■	■	■	SCSI Cable half68pin-half50pin (1.0m)
SCSI Cable	GP5U834	■	■	■	■	■	■	■	■	■	■	■	■	■	■	■	■	■	■	■	SCSI Cable half50pin-full50pin (1.0m)
Fibre Channel Cable	GP5-311	■	■	■	■	■	■	■	■	■	■	■	■	■							Fibre Channel Card (3m) : For FC Card (GP5-FC101)/Giga LAN Card (GP5-183)
Fibre Channel Cable	GP5-312	■	■	■	■	■	■	■	■	■	■	■	■	■							Fibre Channel Card (5m) : For FC Card (GP5-FC101)/Giga LAN Card (GP5-183)
Fibre Channel Cable	GP5-313	■	■	■	■	■	■	■	■	■	■	■	■	■							Fibre Channel Card (15m) : For FC Card (GP5-FC101)/Giga LAN Card (GP5-183)
Fibre Channel Card	GP5-FC101	■	■	■	■	■	■	■	■	■											High-transfer speed of up to 100MB/s, Long transfer distance of up to 500m, PCI-bus, driver is included, Fibre Channel cable is required
LAN Card (1000Base-SX)	GP5-183	■	■	■	■	■	■	■	■	■	■	■	■	■							1000BASE-SX, PCI-bus, driver is included Fibre Channel cable is required : GP5-311/2m, GP5-312/5m, GP5-313/15m
LAN Card	GP5-185	■	■	■	■	■	■	■	■	■	■	■	■	■	■	■	■	■	■	■	100BASE-TX/10BASE-T, PCI-bus, driver is included, Twisted pair cable (category 5:100BASE-TX/category 3:10BASE-T) is required
RCI Card	GP5-RC101				■	■	■														Remote Console Interface Card, For Pedestal type of L800, Standard equipment of L800series Rackmount
Server Monitor Module	GP5USM102		■	■	■	■	■	■	■	■	■	■	■	■	■	■	■	■	■	■	Server Monitor Module has its own CPU,LAN,and power supply (AC adapter: option-procured locally). External Interface:10BASE-T RJ45 / RS232C D-sub 9pin, AC adapter:16V(DC) * Modem-only operation is impossible.
Server Monitor Module	GP5USM103	■	■																		Server Monitor Module has its own CPU,LAN,and power supply (AC adapter: option-procured locally). External Interface:10BASE-T RJ45 / RS232C D-sub 9pin, AC adapter:16V(DC), For HS900 * Modem-only operation is impossible.

*Specifications are subject to change without notice. For the latest detailed information, contact your local representative.
All brand names and product names are trademarks and registered trademarks of their respective holders.*

*© 1999 Fujitsu Limited. All rights reserved. Printed in Japan.
Six Edition November 1999*

FUJITSU LIMITED

Business Development & Marketing Division

Marketing Group

Marunouchi Center Building

6-1, Marunouchi 1-chome, Chiyoda-ku, Tokyo 100-8211, Japan

Phone: +81-3-3215-5255 Fax: +81-3-3215-5259

URL <http://www.fujitsu.co.jp/index-e.html>

BK0065-6NS