

VK-8

Owner's Manual

Thank you, and congratulations on your choice of the VK-8 combo organ.

Before using this unit, carefully read the sections entitled: "IMPORTANT SAFETY INSTRUCTIONS" (p. 2), "USING THE UNIT SAFELY" (p. 3,4), and "IMPORTANT NOTES" (p. 5). These sections provide important information concerning the proper operation of the unit. Additionally, in order to feel assured that you have gained a good grasp of every feature provided by your new unit, owner's manual should be read in its entirety. The manual should be saved and kept on hand as a convenient reference.

Conventions Used in This Manual

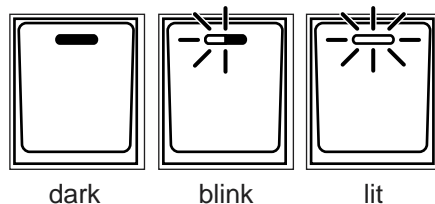

- Button names are enclosed in square brackets; e.g., [REVERB] button.
- Fractional harmonic bars (p. 24) are expressed like this: 1-1/3'; 2-2/3'.
- [1]-[8] means that you should press one of the buttons from [1] through [8].
- The dark/lit/blinking status of an indicator is distinguished as follows.



dark

blink

lit

	CAUTION RISK OF ELECTRIC SHOCK DO NOT OPEN	
ATTENTION: RISQUE DE CHOC ELECTRIQUE NE PAS OUVRIR		
CAUTION: TO REDUCE THE RISK OF ELECTRIC SHOCK, DO NOT REMOVE COVER (OR BACK). NO USER-SERVICEABLE PARTS INSIDE. REFER SERVICING TO QUALIFIED SERVICE PERSONNEL.		



The lightning flash with arrowhead symbol, within an equilateral triangle, is intended to alert the user to the presence of uninsulated "dangerous voltage" within the product's enclosure that may be of sufficient magnitude to constitute a risk of electric shock to persons.



The exclamation point within an equilateral triangle is intended to alert the user to the presence of important operating and maintenance (servicing) instructions in the literature accompanying the product.

INSTRUCTIONS PERTAINING TO A RISK OF FIRE, ELECTRIC SHOCK, OR INJURY TO PERSONS.

IMPORTANT SAFETY INSTRUCTIONS SAVE THESE INSTRUCTIONS

WARNING - When using electric products, basic precautions should always be followed, including the following:

1. Read these instructions.
2. Keep these instructions.
3. Heed all warnings.
4. Follow all instructions.
5. Do not use this apparatus near water.
6. Clean only with a dry cloth.
7. Do not block any of the ventilation openings. Install in accordance with the manufacturers instructions.
8. Do not install near any heat sources such as radiators, heat registers, stoves, or other apparatus (including amplifiers) that produce heat.
9. Do not defeat the safety purpose of the polarized or grounding-type plug. A polarized plug has two blades with one wider than the other. A grounding type plug has two blades and a third grounding prong. The wide blade or the third prong are provided for your safety. When the provided plug does not fit into your outlet, consult an electrician for replacement of the obsolete outlet.
10. Protect the power cord from being walked on or pinched particularly at plugs, convenience receptacles, and the point where they exit from the apparatus.
11. Only use attachments/accessories specified by the manufacturer.
12. Never use with a cart, stand, tripod, bracket, or table except as specified by the manufacturer, or sold with the apparatus. When a cart is used, use caution when moving the cart/apparatus combination to avoid injury from tip-over.
13. Unplug this apparatus during lightning storms or when unused for long periods of time.
14. Refer all servicing to qualified service personnel. Servicing is required when the apparatus has been damaged in any way, such as power-supply cord or plug is damaged, liquid has been spilled or objects have fallen into the apparatus, the apparatus has been exposed to rain or moisture, does not operate normally, or has been dropped.



For the U.K.

WARNING: THIS APPARATUS MUST BE EARTHED
IMPORTANT: THE WIRES IN THIS MAINS LEAD ARE COLOURED IN ACCORDANCE WITH THE FOLLOWING CODE.
 GREEN-AND-YELLOW: EARTH, BLUE: NEUTRAL, BROWN: LIVE

As the colours of the wires in the mains lead of this apparatus may not correspond with the coloured markings identifying the terminals in your plug, proceed as follows:

The wire which is coloured GREEN-AND-YELLOW must be connected to the terminal in the plug which is marked by the letter E or by the safety earth symbol  or coloured GREEN or GREEN-AND-YELLOW.



The wire which is coloured BLUE must be connected to the terminal which is marked with the letter N or coloured BLACK.

The wire which is coloured BROWN must be connected to the terminal which is marked with the letter L or coloured RED.







USING THE UNIT SAFELY

INSTRUCTIONS FOR THE PREVENTION OF FIRE, ELECTRIC SHOCK, OR INJURY TO PERSONS

About  WARNING and  CAUTION Notices







 WARNING	Used for instructions intended to alert the user to the risk of death or severe injury should the unit be used improperly.
 CAUTION	Used for instructions intended to alert the user to the risk of injury or material damage should the unit be used improperly. * Material damage refers to damage or other adverse effects caused with respect to the home and all its furnishings, as well to domestic animals or pets.

About the Symbols







	The  symbol alerts the user to important instructions or warnings. The specific meaning of the symbol is determined by the design contained within the triangle. In the case of the symbol at left, it is used for general cautions, warnings, or alerts to danger.
	The  symbol alerts the user to items that must never be carried out (are forbidden). The specific thing that must not be done is indicated by the design contained within the circle. In the case of the symbol at left, it means that the unit must never be disassembled.
	The  symbol alerts the user to things that must be carried out. The specific thing that must be done is indicated by the design contained within the circle. In the case of the symbol at left, it means that the power-cord plug must be unplugged from the outlet.

ALWAYS OBSERVE THE FOLLOWING

WARNING

- Before using this unit, make sure to read the instructions below, and the Owner's Manual. 
- Do not open or perform any internal modifications on the unit. 
- Do not attempt to repair the unit, or replace parts within it (except when this manual provides specific instructions directing you to do so). Refer all servicing to your retailer, the nearest Roland Service Center, or an authorized Roland distributor, as listed on the "Information" page. 
- Never use or store the unit in places that are:
 - Subject to temperature extremes (e.g., direct sunlight in an enclosed vehicle, near a heating duct, on top of heat-generating equipment); or are 
 - Damp (e.g., baths, washrooms, on wet floors); or are 
 - Humid; or are
 - Exposed to rain; or are
 - Dusty; or are
 - Subject to high levels of vibration.
- This unit should be used only with a rack or stand that is recommended by Roland. 
- When using the unit with a rack or stand recommended by Roland, the rack or stand must be carefully placed so it is level and sure to remain stable. If not using a rack or stand, you still need to make sure that any location you choose for placing the unit provides a level surface that will properly support the unit, and keep it from wobbling. 

WARNING

- The unit should be connected to a power supply only of the type described in the operating instructions, or as marked on the rear side of unit. 
- Use only the attached power-supply cord. 
- Do not excessively twist or bend the power cord, nor place heavy objects on it. Doing so can damage the cord, producing severed elements and short circuits. Damaged cords are fire and shock hazards! 
- This unit, either alone or in combination with an amplifier and headphones or speakers, may be capable of producing sound levels that could cause permanent hearing loss. Do not operate for a long period of time at a high volume level, or at a level that is uncomfortable. If you experience any hearing loss or ringing in the ears, you should immediately stop using the unit, and consult an audiologist. 
- Do not allow any objects (e.g., flammable material, coins, pins); or liquids of any kind (water, soft drinks, etc.) to penetrate the unit. 
- In households with small children, an adult should provide supervision until the child is capable of following all the rules essential for the safe operation of the unit. 
- Protect the unit from strong impact. (Do not drop it!) 

USING THE UNIT SAFELY

WARNING

- Do not force the unit's power-supply cord to share an outlet with an unreasonable number of other devices. Be especially careful when using extension cords—the total power used by all devices you have connected to the extension cord's outlet must never exceed the power rating (watts/amperes) for the extension cord. Excessive loads can cause the insulation on the cord to heat up and eventually melt through. 

- Before using the unit in a foreign country, consult with your retailer, the nearest Roland Service Center, or an authorized Roland distributor, as listed on the "Information" page. 

- Do not put anything that contains water (e.g., flower vases) on this unit. Also, avoid the use of insecticides, perfumes, alcohol, nail polish, spray cans, etc., near the unit. Swiftly wipe away any liquid that spills on the unit using a dry, soft cloth. 

CAUTION

- The unit should be located so that its location or position does not interfere with its proper ventilation. 

- This (VK-8) for use only with Roland stand KS-12. Use with other stands is capable of resulting in instability causing possible injury. 

- Always grasp only the plug on the power-supply cord when plugging into, or unplugging from, an outlet or this unit. 

- Try to prevent cords and cables from becoming entangled. Also, all cords and cables should be placed so they are out of the reach of children. 

- Never climb on top of, nor place heavy objects on the unit. 

- Never handle the power cord or its plugs with wet hands when plugging into, or unplugging from, an outlet or this unit. 

- Before moving the unit, disconnect the power plug from the outlet, and pull out all cords from external devices. 

- Before cleaning the unit, turn off the power and unplug the power cord from the outlet (p. 16). 

CAUTION

- Whenever you suspect the possibility of lightning in your area, pull the plug on the power cord out of the outlet. 

IMPORTANT NOTES

In addition to the items listed under “IMPORTANT SAFETY INSTRUCTIONS” and “USING THE UNIT SAFELY” on pages 2, 3 and 4, please read and observe the following:

Power Supply

- Do not use this unit on the same power circuit with any device that will generate line noise (such as an electric motor or variable lighting system).
- Before connecting this unit to other devices, turn off the power to all units. This will help prevent malfunctions and/or damage to speakers or other devices.
- Although the LCD and LEDs are switched off when the POWER switch is switched off, this does not mean that the unit has been completely disconnected from the source of power. If you need to turn off the power completely, first turn off the POWER switch, then unplug the power cord from the power outlet. For this reason, the outlet into which you choose to connect the power cord’s plug should be one that is within easy reach.

Placement

- Using the unit near power amplifiers (or other equipment containing large power transformers) may induce hum. To alleviate the problem, change the orientation of this unit; or move it farther away from the source of interference.
- This device may interfere with radio and television reception. Do not use this device in the vicinity of such receivers.
- Noise may be produced if wireless communications devices, such as cell phones, are operated in the vicinity of this unit. Such noise could occur when receiving or initiating a call, or while conversing. Should you experience such problems, you should relocate such wireless devices so they are at a greater distance from this unit, or switch them off.
- Do not expose the unit to direct sunlight, place it near devices that radiate heat, leave it inside an enclosed vehicle, or otherwise subject it to temperature extremes. Also, do not allow lighting devices that normally are used while their light source is very close to the unit (such as a piano light), or powerful spotlights to shine upon the same area of the unit for extended periods of time. Excessive heat can deform or discolor the unit.
- When moved from one location to another where the temperature and/or humidity is very different, water droplets (condensation) may form inside the unit. Damage or malfunction may result if you attempt to use the unit in this condition. Therefore, before using the unit, you must allow it to stand for several hours, until the condensation has completely evaporated.

- Do not allow rubber, vinyl, or similar materials to remain on the unit for long periods of time. Such objects can discolor or otherwise harmfully affect the finish.
- Do not allow objects to remain on top of the keyboard. This can be the cause of malfunction, such as keys ceasing to produce sound.
- Do not paste stickers, decals, or the like to this instrument. Peeling such matter off the instrument may damage the exterior finish.

Maintenance

- To clean the unit, use a dry, soft cloth; or one that is slightly dampened. Try to wipe the entire surface using an equal amount of strength, moving the cloth along with the grain of the wood. Rubbing too hard in the same area can damage the finish.
- Never use benzine, thinners, alcohol or solvents of any kind, to avoid the possibility of discoloration and/or deformation.

Additional Precautions

- Use a reasonable amount of care when using the unit’s buttons, sliders, or other controls; and when using its jacks and connectors. Rough handling can lead to malfunctions.
- When connecting / disconnecting all cables, grasp the connector itself—never pull on the cable. This way you will avoid causing shorts, or damage to the cable’s internal elements.
- A small amount of heat will radiate from the unit during normal operation.
- To avoid disturbing your neighbors, try to keep the unit’s volume at reasonable levels. You may prefer to use headphones, so you do not need to be concerned about those around you (especially when it is late at night).
- When you need to transport the unit, package it in the box (including padding) that it came in, if possible. Otherwise, you will need to use equivalent packaging materials.
- Use only the specified expression pedal (EV-7; sold separately). By connecting any other expression pedals, you risk causing malfunction and/or damage to the unit.

Contents

Conventions Used in This Manual	1
USING THE UNIT SAFELY	3
IMPORTANT NOTES	5
Main Features	9
Panel Descriptions.....	10
How the VK-8 Works.....	13
About the Virtual Tonewheel Sound Generator.....	13
How the Organ Sound are Created	13
How the Other Tones are Created	14
About the Memories	15
Before You Begin Playing	16
Connecting the Power Cord.....	16
Connecting Your Amp, Speakers, or Headphones.....	17
Connecting the Pedal Keyboard.....	18
Connecting an Expression Pedal or Pedal Switch	18
Turning the Power On	19
Turning Off the Power	19
Restoring the Factory Settings (Factory Reset).....	20
Listening to the Demo Songs	21
Playing the Organ	22
Listening to Various Sounds.....	22
About the Organ Voice	23
Adjusting the Sound in Real Time (Harmonic Bars).....	24
Changing the Organ Sound (Wheel Type, Leakage Level)	27
Adding Crispness to the Sound (Percussion).....	28
Adding Modulation to the Sound (Vibrato and Chorus)	31
Using the COSM Rotary Speaker Effect (Rotary Sound).....	32
Changing the Amp Type (Amp Type, Overdrive, Tone)	33
Using the D BEAM Controller to Produce Common Organ Effects.....	34
Adjusting the Sensitivity of the D Beam Controller.....	36
Adding Ambience (Reverb)	37
Dividing the Keyboard (Split)	38
Changing the Split Point	38
Using the Expression Pedal	39
Using the Active Expression Function.....	39
Using a Control Pedal.....	40
Assigning a Function to the Control Pedal	40
Using the Hold Pedal to Sustain the Sound	42
Playing Other Tones	43
Layering Other Tones with Organ Sounds (Layer).....	43
Assigning Organ Sounds and Other Tones Across the Keyboard (Split)	44
Saving Your Settings (Preset)	45
Saving to a Preset in the Same Bank.....	46
Saving to a Preset in Another Bank.....	46
Copying a preset	46

Advanced Use	47
About the Edit Modes	47
Basic Procedure	47
Settings That Are Saved for the Entire System	49
Rotary-related Settings.....	49
Click Noise and Percussion Settings	51
MIDI-related Settings	52
Equalizer and Other Settings.....	55
Parameters that are stored in a preset	56
Effect and Other Settings	56
Connecting the VK-8 to External Devices	58
Playing the VK-8 from an External MIDI Device	58
Changing the function of the MIDI IN connectors (SUB KEYBOARD FUNCTION).....	58
Using the VK-8 with a Dual Keyboard	59
Connecting a Pedal Keyboard.....	59
Using an External Sequencer to Record and Play Back.....	60
Saving VK-8 Settings on an External Sequencer (Bulk Dump).....	61
Loading Back Data That's Been Saved on an External Sequencer	61
Connecting a Rotary Speaker	62
Troubleshooting.....	63
Error Indications.....	66
Preset/OTHER TONES List.....	67
Preset List	67
OTHER TONES List.....	68
Edit Parameters.....	69
Drum List	70
MIDI Implementation	71
MIDI Implementation Chart	77
Main Specification	78
Index.....	79

MEMO

Main Features

Organ Features

Virtual Tonewheel Sound Generator

The VK-8 features a Virtual Tonewheel sound generator that perfectly simulates the sound-production mechanism of traditional tone wheel organs. Since all parts — upper, lower, and pedal — are completely polyphonic, notes aren't cut off regardless of your performance technique.

Rotary Sound

An effect algorithm using Roland's COSM technology creates a faithful rotary speaker simulation that's essential for a great organ sound. Enjoy the realistic rotary sound simply by connecting headphones, a keyboard amp (such as the KC-1000) or stereo system.

Overdrive Sound

In addition to simulating the response of the rotary speaker's vacuum tube circuitry and the acoustical characteristics of the speaker cabinet, COSM technology also re-creates the sound of various types of amplifiers. Simply by selecting amp types, you can obtain a wide variety of sounds, including heavy overdrive rock sounds with realistic cabinet resonance.

Waterfall Keyboard

The VK-8 features the same keyboard feel as traditional tone wheel organs. This keyboard has been newly designed for standard organ playing techniques such as glissando.

Intuitive Operation

The VK-8 is designed with an emphasis on operability, with harmonic bars, rotary knobs, and large buttons. The VIBRATO AND CHORUS and PERCUSSION controls feature the same operation and placement as on traditional tone wheel organs.

Tone wheel Type, Leakage Noise, Amp Simulator, and other elements vital to creating a great organ sound can be edited directly and intuitively from the front panel just as if you were adjusting the sound on a guitar amp.

Natural Wood Cabinet

The cabinet is built of wood, echoing the construction of traditional tone wheel organs. The side panels feature beautifully finished natural wood that will gain luster with years of use.

Built-in PCM Sounds Complement the Organ Sound Generator

In addition to its organ sound generator, the VK-8 provides a PCM sound generator with high-quality Piano, Electric Piano 1, Electric Piano 2, Strings, Jazz Scat, Choir, Synth, and Brass sounds. These sounds can be used in combination with the organ for even greater expressive potential.

Other Features

- You can use the D BEAM controller to create performance gestures unique to traditional tone wheel organs, such as turning the tone wheel motor off or producing the “splash” of a quick kick to a spring reverb unit. Take advantage of the D BEAM controller to heighten the excitement of your performances onstage.
- A dedicated rotary speaker connector is provided. Rotary speakers with an eleven-pin connector can be connected directly to the VK-8.
- Two MIDI IN connectors are provided on the rear panel, allowing you to connect another keyboard and pedal keyboard and enjoy two-manual and pedal keyboard playing.
- User Preset memory lets you store 64 different panel settings.
- In addition to Expression Pedal and Hold Pedal jacks, a Control Pedal jack is provided that can be assigned a variety of functions. By connecting an expression pedal or pedal switch, you can enjoy a wide range of performance possibilities.

Panel Descriptions

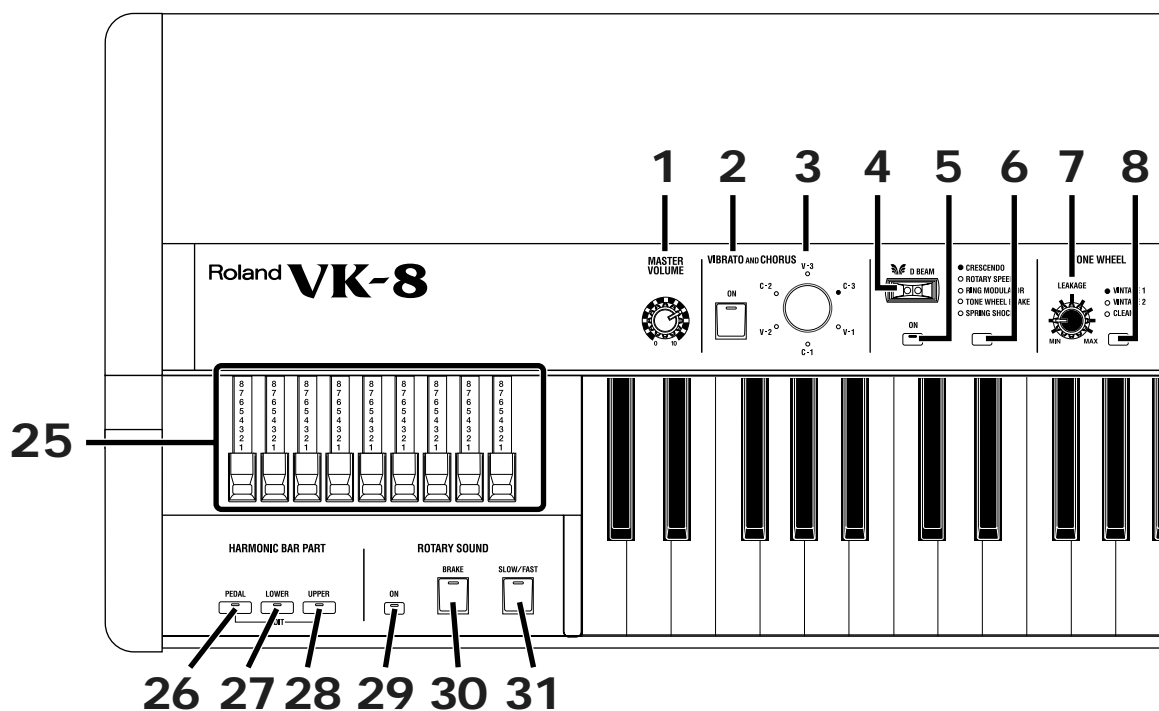

1. **[MASTER VOLUME] knob**
Adjust the overall volume (p. 19).
- **VIBRATO AND CHORUS**
2. **VIBRATO AND CHORUS [ON] button**
Switches the vibrato or chorus effect on/off (p. 31).
3. **[VIBRATO AND CHORUS] knob**
Switches the type of vibrato or chorus effect (p. 31).
- **D BEAM**
4. **D BEAM controller**
You can modify the sound by moving your hand over the D Beam controller (p. 34).
5. **D BEAM [ON] button**
Switches the D Beam controller on/off (p. 34).
6. **D BEAM button**
Selects the effect that will be controlled by the D Beam controller (p. 34).
- **TONE WHEEL**
7. **[LEAKAGE] knob**
Allows you to independently add leakage noise, separately from the leakage noise selected by the wheel type (p. 27).
8. **[TONE WHEEL] button**
Select the type of the virtual tonewheel (p. 27).
- **AMPLIFIER**
9. **[OVERDRIVE] knob**
Adjust the depth of overdrive (p. 33).
10. **[AMPLIFIER] button**
Switches the frequency response and cabinet resonance of the virtual amp (p. 33).
11. **[TONE] knob**
Adjust the tonal character of the organ voice (p. 33).
- **REVERB**
12. **REVERB [LEVEL] knob**
Adjust the depth of reverb (p. 37).
13. **[REVERB] button**
Select the type of reverb (p. 37).
- **OTHER TONES**
14. **[SPLIT] button**
Divide the keyboard into two halves, and assign a different sound to each area (p. 38, 44).
15. **[H-BAR MANUAL] button (Harmonic Bar Manual)**
When this function is used, the harmonic bar settings will change from the settings of the preset to the positions (settings) of the harmonic bars on the panel (p. 23).
16. **[WRITE] button**
Saves the panel settings as a preset (p. 45, 46).
17. **[BANK] button**
Selects the preset bank (p. 22, 45, 46).
18. **[PRESET] button**
Pressed to enter Preset Select mode (p. 22, p. 45). Allows the [1]-[8] buttons to be used for selecting presets.
25. **[HARMONIC BAR PART]**
26. **PEDAL**
27. **LOWER**
28. **UPPER**
29. **ON**
30. **BRAKE**
31. **SLOW/FAST**

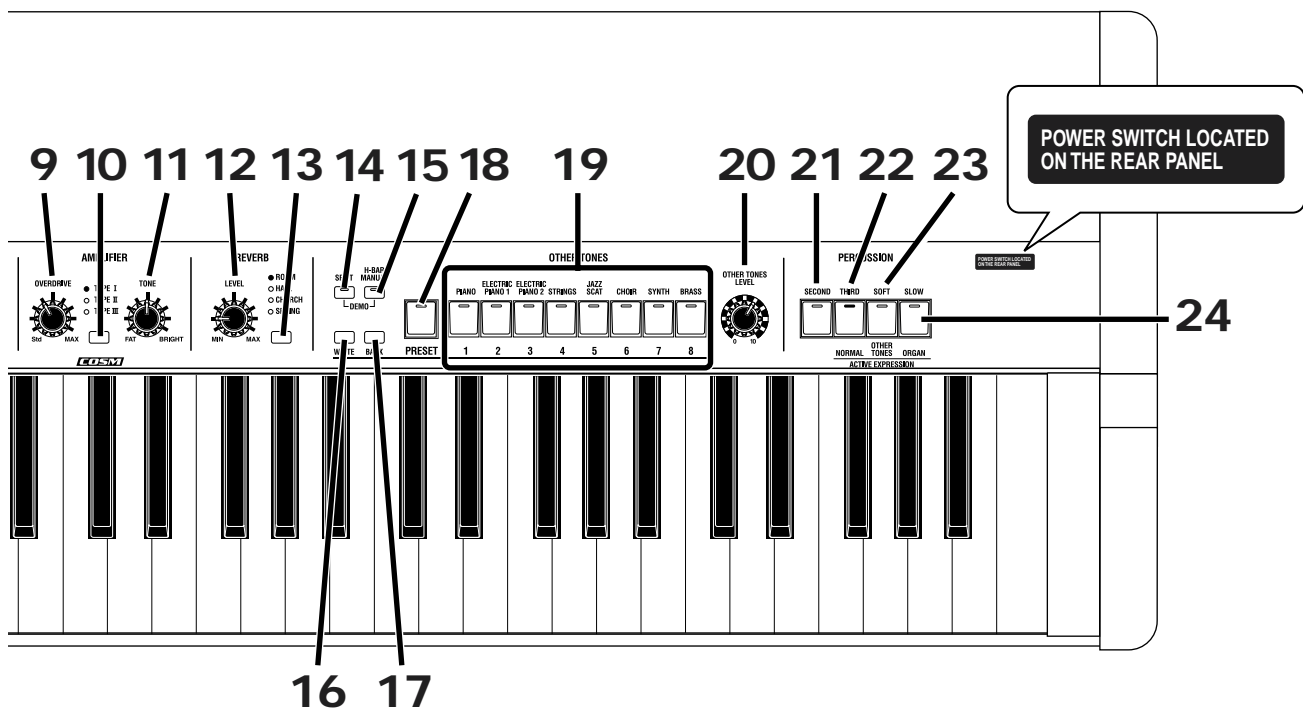

19. [1]-[8] button

When the [PRESET] button's indicator is lit, the [1]-[8] buttons will switch presets. When the [PRESET] button's indicator is dark, the [1]-[8] buttons will switch OTHER TONES.

- [1/(OTHER TONES) PIANO] button
- [2/(OTHER TONES) ELECTRIC PIANO 1] button
- [3/(OTHER TONES) ELECTRIC PIANO 2] button
- [4/(OTHER TONES) STRINGS] button
- [5/(OTHER TONES) JAZZ SCAT] button
- [6/(OTHER TONES) CHOIR] button
- [7/(OTHER TONES) SYNTH] button
- [8/(OTHER TONES) BRASS] button

20. [OTHER TONES LEVEL] knob

Adjust the volume of the OTHER TONES.

■ PERCUSSION

21. [SECOND] button

This adds second percussion (same pitch as the 4' harmonic bar) to the organ voice (p. 28).

22. [THIRD] button

This adds third percussion (same pitch as the 2-2/3' harmonic bar) to the organ voice (p. 28).

23. [SOFT] button

This switches the volume of the percussion (p. 29).

24. [SLOW] button

This switches the decay time of the percussion (p. 30).

25. Harmonic Bar

These bars create the sound of the organ voice. You can modify the tone in real time as you play (p. 24).

■ HARMONIC BAR PART

These buttons select the part whose settings the harmonic bars will affect.

26. [PEDAL] button

When the harmonic bars are moved, the sound of the Pedal part will change (p. 23).

27. [LOWER] button

When the harmonic bars are moved, the sound of the Lower part will change (p. 23).

28. [UPPER] button

When the harmonic bars are moved, the sound of the Upper part will change (p. 23).

■ ROTARY SOUND

29. ROTARY [ON] button

This button switches the rotary effect on/off for the organ sound (p. 32).

30. [BRAKE] button

This button switches the rotation of the rotary sound. When this is turned on, the rotation will gradually stop. When it is turned off, the rotation will gradually resume (p. 32).

31. [SLOW/FAST] button

This button switches the speed of rotation for the rotary sound (p. 32).

- | | |
|----------------|---------------|
| Rapid blinking | Fast rotation |
| Slow blinking | Slow rotation |

Panel Descriptions

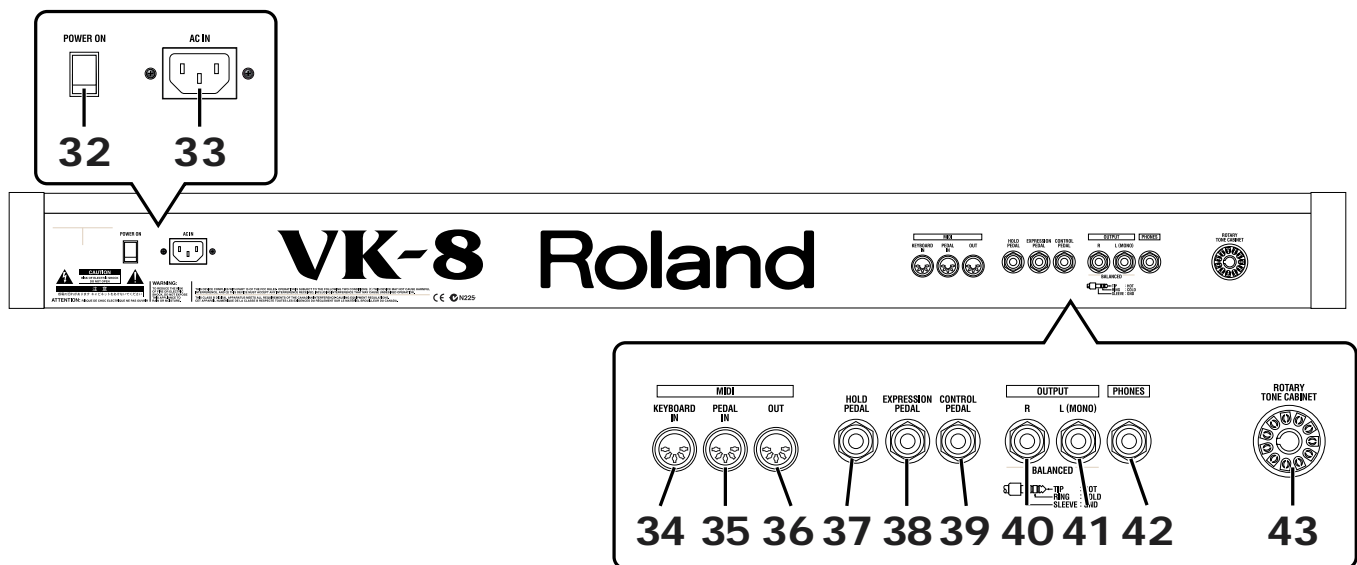

REAR PANEL

32. [POWER] switch

Turn the power on/off (p. 19).

33. AC Inlet

Connect the included power cable to this inlet (p. 16).

34. MIDI KEYBOARD IN connector

An external keyboard can be connected here, allowing you to play the VK-8 as a two-manual instrument (p. 59). You could also connect an external sequencer here, and get the VK-8 to play the music the sequencer sends it (p. 60).

35. MIDI PEDAL IN connector

A pedal keyboard can be connected here, allowing you to play the pedals (p. 59).

You could also connect an external sequencer here, and get the VK-8 to play the music the sequencer sends it (p. 60).

36. MIDI OUT connector

An external MIDI device can be connected here to receive MIDI data transmitted from the VK-8 (p. 60, p. 61).

37. HOLD PEDAL jack

A pedal switch can be connected here. While you press the pedal, the organ voice or other voice you are playing will be sustained (p. 18, 42).

38. EXPRESSION PEDAL jack

An expression pedal (EV-5 or EV-7; sold separately) can be connected here (p. 18, p. 39).

39. CONTROL PEDAL jack

Accepts connection of a pedal switch or expression pedal. The desired function can be assigned to the pedal (p. 18, p. 40).

40. OUTPUT R jack

41. OUTPUT L (MONO) jack

An amp, powered speakers, etc., can be connected here. If outputting in monaural, connect to the L (MONO) jack (p. 17).

42. PHONES jack

An optional set of headphones can be connected here (p. 17).

43. ROTARY TONE CABINET connector

Rotary speaker can be connected (p. 62).

How the VK-8 Works

About the Virtual Tonewheel Sound Generator

A traditional tone wheel organ produces the sound by 91 toothed wheels called “tone wheels.” Each tone wheel produces a different pitch. A motor is used to rotate these tone wheels past electromagnetic coils, and as the teeth of each wheel pass by the corresponding electromagnetic coil, an audio signal is generated. The combination of harmonic bars and the notes that are pressed then select the audio signals that are output, producing the sound of the organ.

The virtual tonewheel sound generator of the VK-8 uses digital technology to precisely re-create the sound-production mechanism of a tone wheel organ. The 91 toothed wheels are constantly “rotating” digitally, and are able to produce sound at any time. The sound produced by these virtual tonewheels is determined by the combination of harmonic bars and the state of the notes played on the keyboard—exactly as on traditional tone wheel organs.

How the Organ Sound are Created

Tone Wheels

Tone wheels rotate constantly, and will therefore “speak” the instant you play a note. The virtual tonewheel sound generator of the VK-8 is also producing sound constantly, allowing very rapid response when you play a note. This rapid response is especially valuable when you use characteristic organ performance techniques such as glissando.

The organ sound consists of a fundamental and eight harmonics, and these are mixed according to the combination of the harmonic bars. You can use the harmonic bars to modify the tone even while you play, allowing a high degree of expressive flexibility.

Percussion

Tone wheel percussion is used when you want to add an attack to the notes you play, making the sound more crisp. Relative to the pitch of the note you play, you can specify either the second (SECOND) or third (THIRD) partial as the pitch of the percussion sound, and you can decrease the percussion volume (SOFT) or lengthen its decay (SLOW).

The percussion on tone wheel organs is of a type called “single-trigger,” meaning that percussion was not applied to all the notes that were played, but only to the note that was pressed first. If you release the currently-played key(s), percussion will sound for the next-played note. If you play legato (with notes smoothly connected), percussion will be applied only to the first note, and not to subsequent notes. If you play staccato, percussion will be applied to all notes. If you play rapidly when using percussion, the percussion circuit may not keep up with your playing, causing the percussion sound to become softer. However, the VK-8 allows you to adjust the speed of recovery so that it will keep up even with rapid playing (p. 51). On a tone wheel organ, the way in which percussion is applied is a very important element in enhancing the expressiveness of the performance.

On tone wheel organs, the 1' harmonic bar was used to produce the percussion sound. This means that when you add percussion, the sound of the 1' harmonic bar will no longer be heard. Also, percussion will be applied only to the Upper Part.

On tone wheel organs, turning off percussion [SOFT] button would lower the volume of the organ, but the VK-8 allows you to adjust it so the volume of the organ won't change when percussion [SOFT] button is switched on/off (p. 51).

Key Click

The first generations of traditional tone wheel organs produced a “blip” noise (separately from percussion) when a note was pressed or released. Initially, this click noise was considered a problem, but blues and rock musicians came to utilize it in their performances, and the key click became an indispensable part of the organ sound in jazz as well.

On the VK-8 you can independently adjust the volume of the key click for key-on and key-off (p. 51).

How the VK-8 Works

Vibrato and Chorus

Traditional tone wheel organs provided a total of six different effects: three kinds of vibrato (V1, V2, V3) and three kinds of chorus (C1, C2, C3).

Vibrato is an effect that cyclically modulates the pitch, and chorus is an effect that modulates the pitch to produce spaciousness and depth.

Harmonic bars

The harmonic bars of a tone wheel organ are arranged in ascending order of pitch, from left to right. Borrowing some inspiration from the pipes of a pipe organ, the bars are labeled in “feet,” with 8’ being the fundamental.

There is one exception in the ordering of the harmonic bars, and that is the 5-1/3’ bar located second from the left. According to the pitch order, this should be the third from the left, but since 5-1/3’ is an overtone of 16’, and blends with the 16’ sound, it is placed beside the 16’ bar.

The harmonic bars are color-coded in three colors. The bars whose pitches are in octave relation to 8’ are white, the bars that are not octave harmonics are black, and the lower pitch range is brown.

On tone wheel organs, the highest feet were repeated (“reused”) in the high keyboard range, and the lowest feet were repeated in the low range. This is called “fold-back.”

If an organ had 109 tone wheels, all nine harmonics of the harmonic bars could be sounded by all 61 keys of a tone wheel organ. However, if this were the case, the upper range would be unpleasantly screechy, and the lower range would be excessively low and muddy-sounding.

For this reason, fold-back is used on the VK-8 to produce a well-balanced sound.

Amp Type (Rotary, Overdrive, Tone)

By using a rotary speaker with a tone wheel organ, you can create modulation and a sense of rotation, producing a spacious, three-dimensional sound.

On the VK-8, the volume of the rotary speaker, the time over which rotation will transition between fast and slow, the speed of rotation in fast and slow states, and the sense of spaciousness can each be adjusted independently for the tweeter and woofer.

Reverb

Reverb is an effect that adds reverberation to the sound. Reverb types ROOM, HALL, and CHURCH add the reverberation of differently sized acoustical spaces. The SPRING reverb type simulates a reverb circuit that used springs, and was often found on traditional organs.

The VK-8 lets you adjust the reverb time (p. 57). Also, by turning the [REVERB] knob you can adjust the volume of the reverb (p. 37).

How the Other Tones are Created

The VK-8 also contains sounds other than organ sounds. These are referred to as “OTHER TONES.” OTHER TONES can be played on Upper, Lower, or Pedal.

OTHER TONES provide the following eight sounds.

1. PIANO
2. ELECTRIC PIANO 1
3. ELECTRIC PIANO 2
4. STRINGS
5. JAZZ SCAT
6. CHOIR
7. SYNTH
8. BRASS

About the Memories

System memory

Settings that affect the entire VK-8 are referred to as “system memory.”

Preset memory

Settings that are stored independently for each preset number, such as harmonic bar and panel settings, are called “preset memory.”

There are a total of 64 preset memories, and each of them can be edited.

Before You Begin Playing

Connecting the Power Cord

- 1** Before making a connection, make sure that the VK-8 is turned off.
- 2** Connect supplied power cable to the VK-8, and plug the other end into a power outlet.

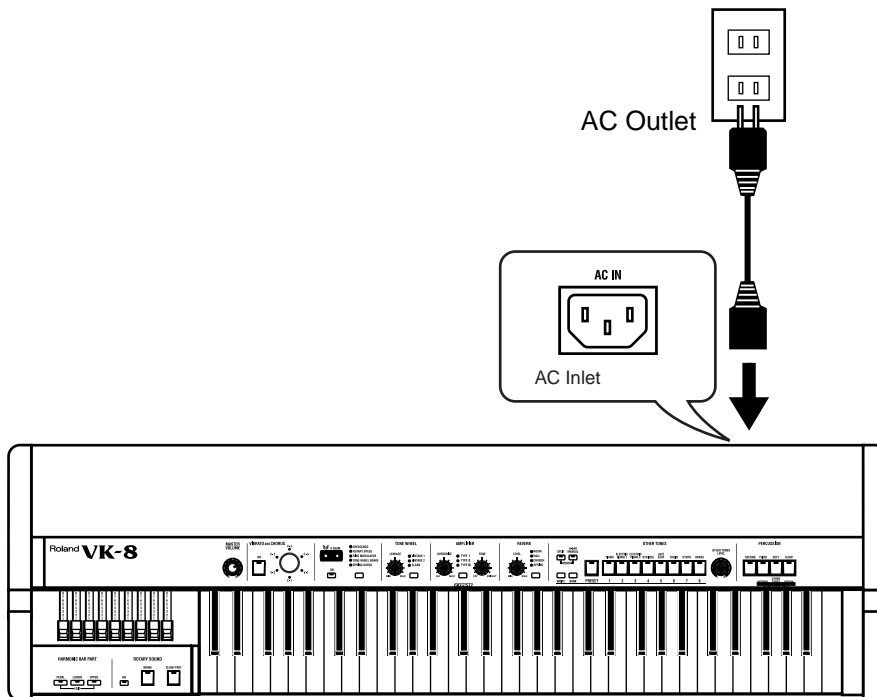

NOTE

To prevent malfunction and/or damage to speakers or other devices, always turn down the volume, and turn off the power on all devices before making any connections.

NOTE

Be sure to use the supplied power cable.

Connecting Your Amp, Speakers, or Headphones

The VK-8 is not equipped with an amplifier or speakers. In order to hear the sound, you will need to connect audio equipment such as a monitor speaker system or stereo set, or use headphones.

- 1 Before making any connections, make sure that all the devices are turned off.
- 2 Connect the VK-8 to your amp/speaker system as shown in the diagram.

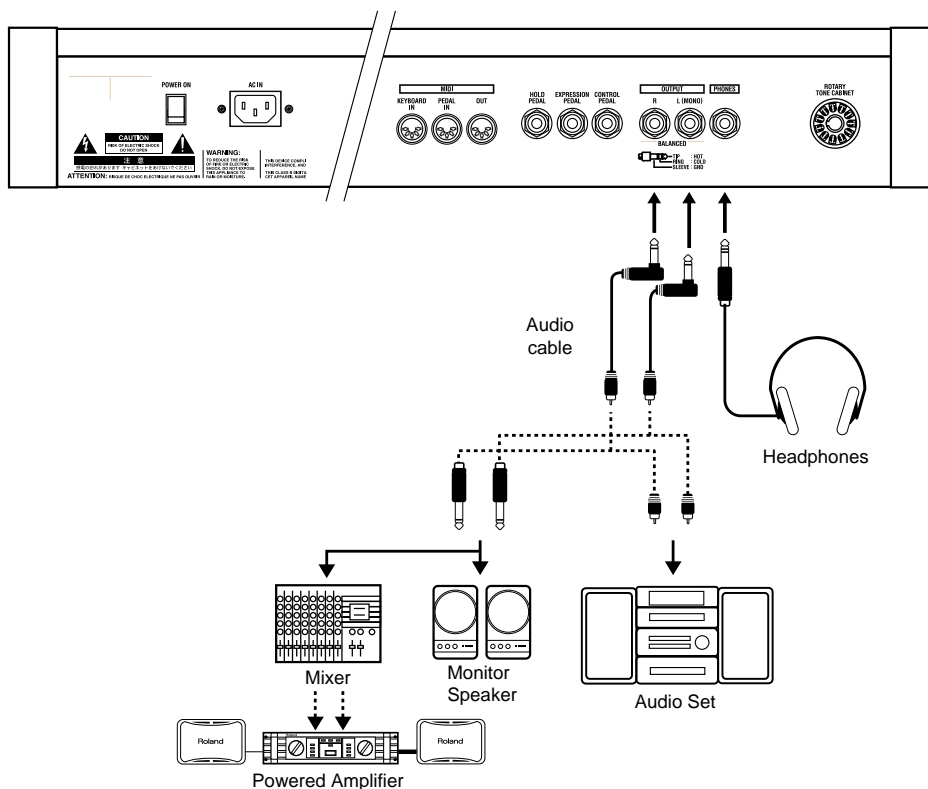

Use audio cables to connect audio equipment, such as an amp or speakers. If you are using headphones, plug them into the PHONES jack.

About a OUTPUT jacks

The VK-8's OUTPUT jacks support both balanced output and unbalanced output. To use balanced output, use a cable with a balanced (TRS type) phone plug. To use unbalanced output, use a cable with an unbalanced (TS type) phone plug.

TRS

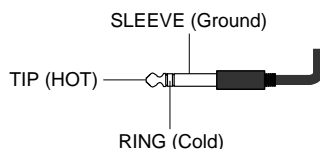

TS

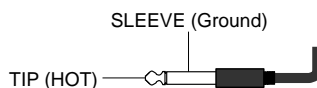

NOTE

To prevent malfunction and/or damage to speakers or other devices, always turn down the volume, and turn off the power on all devices before making any connections.

MEMO

In order to take full advantage of the VK-8's performance, we recommend using a stereo amp/speaker system. If you are using a mono system, make the connections to the OUTPUT L (MONO) jack.

NOTE

In consideration of live concert situations, the VK-8's PHONES jack is designed to produce a higher volume level than that of other electronic instruments. Extended listening at high volume levels may damage your hearing, so use caution when adjusting the volume.

MEMO

Audio cables and headphones are not included. You will need to provide these separately.

Before You Begin Playing

Connecting the Pedal Keyboard

- 1 Before making any connections, make sure that all the devices are turned off.
- 2 Use a commercially available MIDI cable to connect the VK-8's MIDI PEDAL IN connector to the MIDI OUT connector of your MIDI pedal keyboard unit.

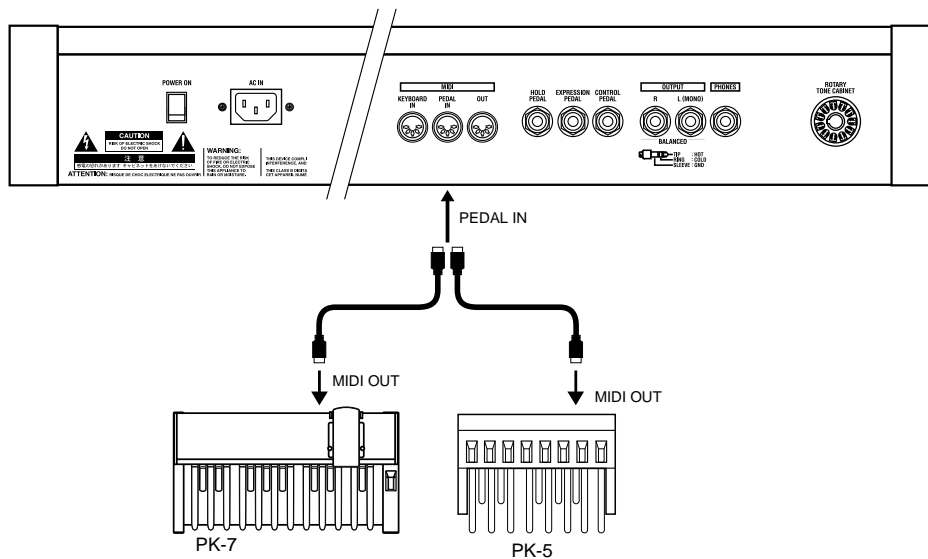

- 3 Turn on the MIDI pedal keyboard unit.
- 4 Turn on the power of the VK-8.

Connecting an Expression Pedal or Pedal Switch

You can connect an expression pedal or pedal switch to the rear panel EXPRESSION PEDAL jack, HOLD PEDAL jack, or CONTROL PEDAL jack.

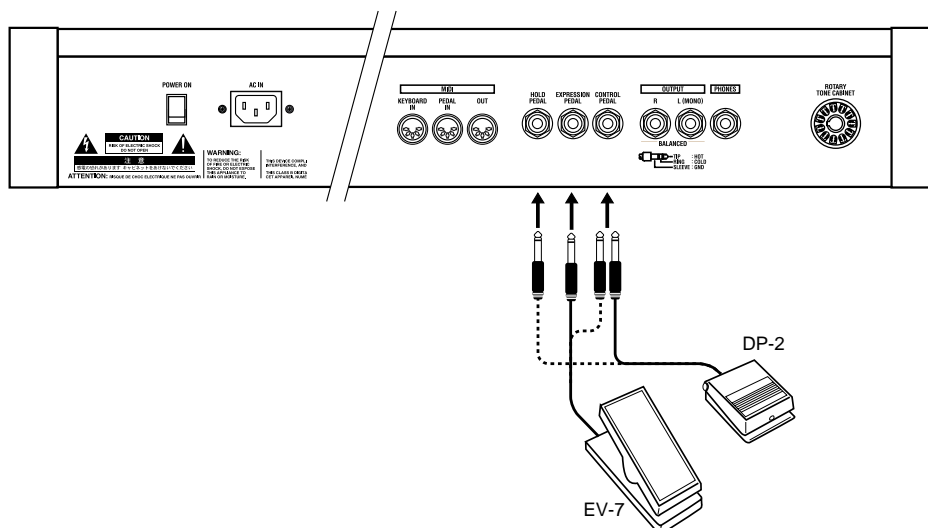

If the SUB KEYBOARD FUNCTION (p. 58) is turned on, it will not be necessary to specify the MIDI channel.



The power switch of your MIDI pedal keyboard unit must be turned on before the power switch of the VK-8. When you turn off the power, first turn off the power of the VK-8, and then turn off the power of your MIDI pedal keyboard.



Use only the specified expression pedal (EV-7; sold separately). By connecting any other expression pedals, you risk causing malfunction and/or damage to the unit.

Turning the Power On

1 Before turning on the VK-8's power, make sure that:

- The VK-8 is correctly connected to the desired peripheral devices.
- The volume of the VK-8 and any connected audio equipment or speakers is turned to the minimum position.

2 Press the upper portion of the [POWER] switch located on the rear panel of the VK-8 to turn on the power.

When the power is on, the indicators for the HARMONIC BAR PART [UPPER] button, [REVERB] button, and other buttons on the panel will light.

POWER ON

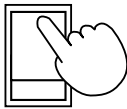

3 Turn on the power of the connected amp or audio system.

4 Rotate the [MASTER VOLUME] knob clockwise to adjust the volume of the VK-8.

MASTER VOLUME

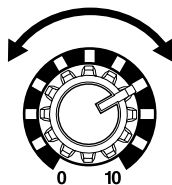

5 Adjust the volume of the device connected to the VK-8.

■ Turning Off the Power

1 Before switching off the power, confirm the following:

- The volume of the VK-8 and any connected equipment is turned to the minimum position.
- Any sound data you have created has been saved.

2 Turn off the power of the equipment connected to the VK-8.

3 Press the lower portion of the VK-8's [POWER] switch to turn off the power.

POWER ON

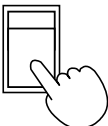

NOTE

Once the connections have been completed, turn on power to your various devices in the order specified. By turning on devices in the wrong order, you risk causing malfunction and/or damage to speakers and other devices.

NOTE

This unit is equipped with a protection circuit. A brief interval (a few seconds) after power up is required before the unit will operate normally.

NOTE

Be careful not to raise the volume excessively. Excessive volume may damage your amp/speaker system/headphones or could cause hearing problems.

NOTE

If you turn off the power while you are making sound settings, the settings that you are modifying will be lost. If you wish to keep your modified settings, you must save them before turning off the power. For details, refer to "Saving Your Settings (Preset)" (p. 45).

Restoring the Factory Settings (Factory Reset)

This function resets all the VK-8's settings to their factory default values.

- 1** Make sure that the volume is turned to the minimum position.
- 2** Press the lower portion of the VK-8's [POWER] switch to turn off the power.

POWER ON

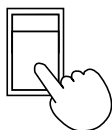

- 3** While holding down the HARMONIC BAR PART [UPPER] [LOWER] [PEDAL] buttons, press the upper portion of the [POWER] switch to turn on the power.
- 4** Press the HARMONIC BAR PART [UPPER] [LOWER] [PEDAL] buttons until all of the panel indicators light.

All settings will be restored to what they were when the instrument first left the factory.

Once the Factory Reset has been completed, all panel indicators will light for several seconds.

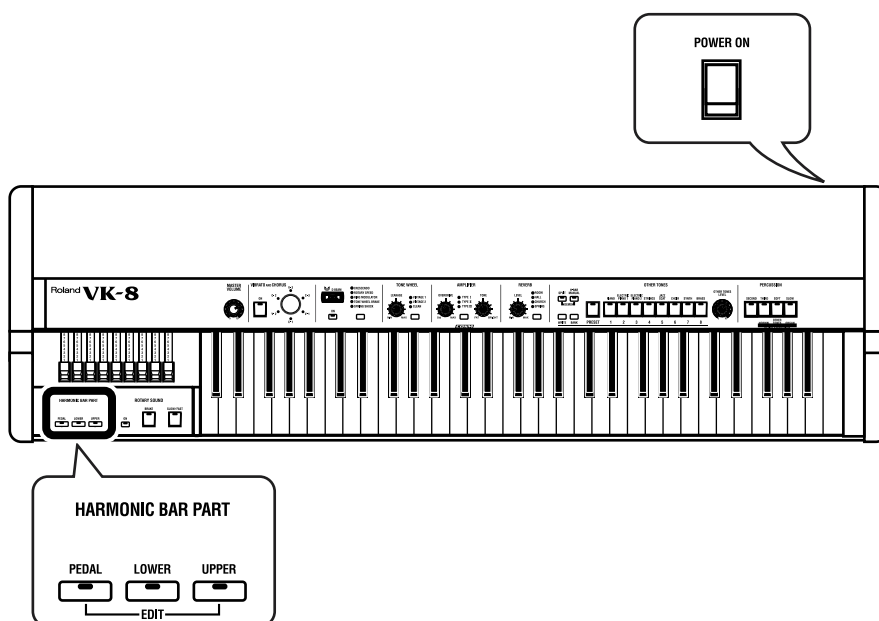

NOTE

When you perform the Factory Reset operation, all the data you created will be lost from the VK-8's internal memory. If the VK-8 contains important data that you wish to keep, use the Bulk Dump operation to save the data on an external MIDI sequencer, etc. before you perform the Factory Reset operation (p. 61).

NOTE

Never turn off the power while Factory Reset is being performed.

Listening to the Demo Songs

The VK-8 contains six demo songs. Here's how to listen to the demo songs and experience the various organ sounds and effects.

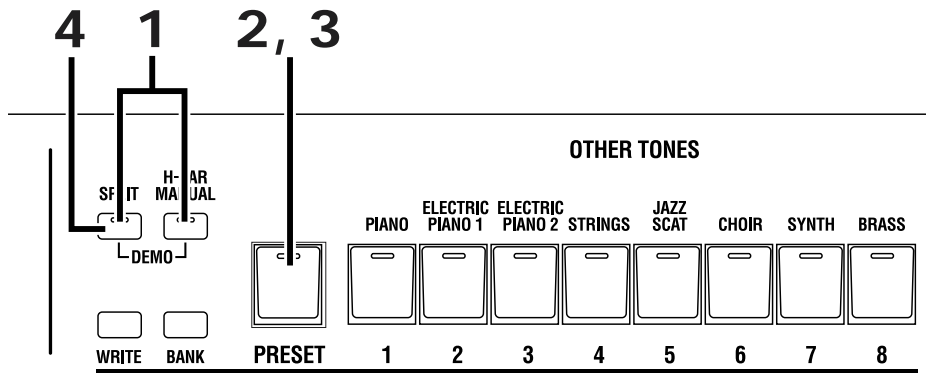

1 Press the [SPLIT] button and the [H-BAR MANUAL] button at the same time.

Enter Demo mode.

2 Press the [PRESET] button to make its indicator light.

The demo songs will be chain-played (played in succession) starting with the first song.

When the first demo song finishes playing, playback will continue to the next song. When the last song finishes playing, playback will return to the first song and continue.

3 Press the [PRESET] button once again to make the indicator go out.

Demo song playback will stop.

4 Press the [SPLIT] button.

You will exit Demo mode.

Demo Song Number	Song Name	Copyright
1	Blue Forest	© 2002 Roland Corporation
2	Sunset Blvd	© 2002 Roland Corporation
3	Medical Fact	© 2002 Tatsuya Nishiwaki
4	Let's Get Ready to Praise	© 2002 Roland Corporation
5	Make Holy	© 2002 Roland Corporation
6	Sister Mum	© 2002 Roland Corporation

MEMO

Before you press the [PRESET] button, you can press a button [1]-[6] to select the song from which demo song playback will begin.

NOTE

No data for the music that is played will be output from MIDI OUT.

NOTE

All rights reserved. Unauthorized use of this material for purposes other than private, personal enjoyment is a violation of applicable laws.

NOTE

The third Demo song is created by using the Spring Shock effect. Please be aware that raising the volume of the VK-8 excessively will produce a high-volume impact sound. If you want to reduce the volume of the impact sound, use the [MASTER VOLUME] knob to adjust the volume of the VK-8.

Playing the Organ

Listening to Various Sounds

The VK-8 comes with 64 presets stored onboard. Here's how to switch presets to hear the various sounds.

There are eight banks of presets, with eight sounds in each bank.

Switch between the presets to hear the various sounds.

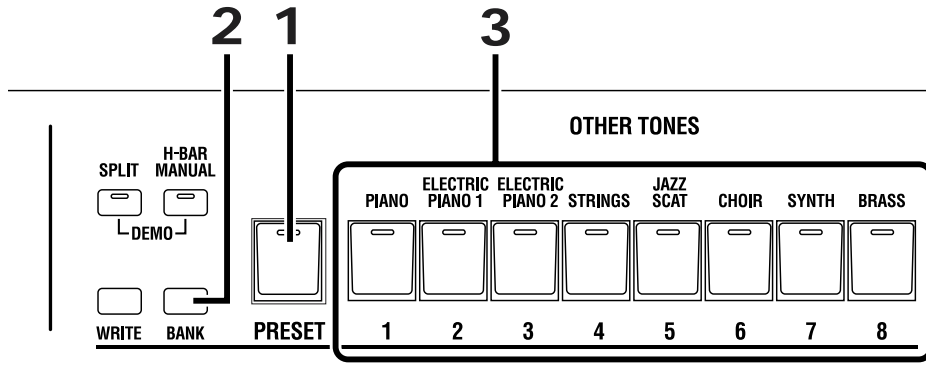

- 1** Press the [PRESET] button to make its indicator light.
- 2** Hold down the [BANK] button and press one of the buttons from [1] through [8] to select the bank number.
- 3** Press one of the buttons from [1] through [8] to select a preset number.
The indicator of the number button you've selected will light.
- 4** Play the keyboard to hear the sound you selected.

Example:

- **Switching from preset 11 to preset 18**

Press the [8] button.

- **Switching from preset 11 to preset 35**

Hold down the [BANK] button and press the [3] button. Take your finger off the [BANK] button, and press the [5] button.



If you want to select a preset from the same bank, step 2 is not necessary.



While you are pressing the [BANK] button, the indicator of the selected bank will light.

About the Organ Voice

The organ voice has three parts: “upper,” “lower,” and “pedal.”

When you play the keyboard of the VK-8, the sound of the Upper part will be heard.

You can also play the VK-8 in the following ways.

- Divide the keyboard of the VK-8 into two zones, and play the sound of the Upper organ part in the right-hand zone, and the sound of the Lower organ part in the left-hand zone (p. 38).
- Connect an external keyboard, and play the sound of the Upper organ part on the VK-8’s keyboard, and the sound of the Lower organ part on the external keyboard (p. 59).
- Connect an external pedal keyboard, and play the sound of the Upper organ part on the VK-8, and the sound of the Pedal organ part on the pedal keyboard (p. 59).

The sounds of the Upper, Lower, and Pedal parts of an organ voice can be edited using the harmonic bars.

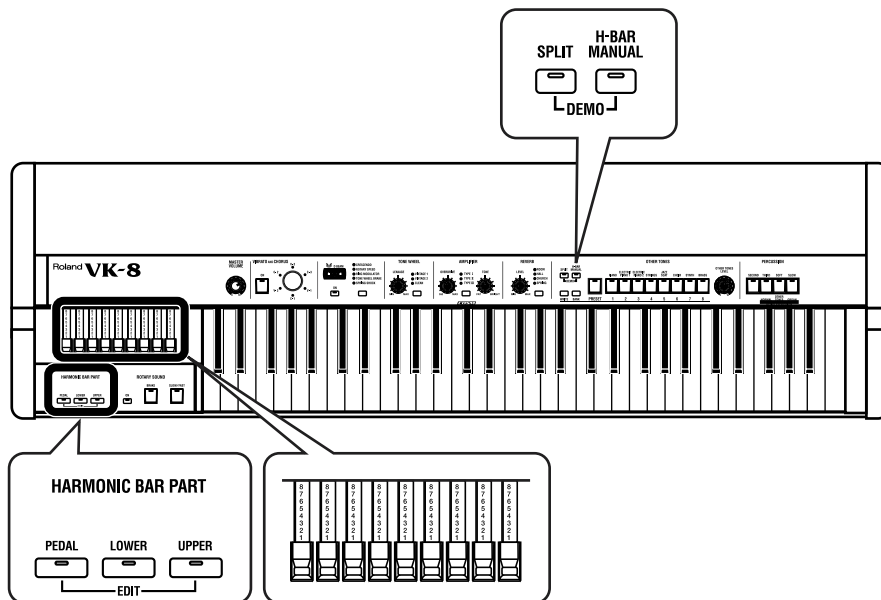

- 1 Press either the HARMONIC BAR PART [UPPER] button, [LOWER] button, or [PEDAL] button to select the part whose sound you want to edit.**

Button	Part
HARMONIC BAR PART [UPPER] Button	Upper Part
HARMONIC BAR PART [LOWER] Button	Lower Part
HARMONIC BAR PART [PEDAL] Button	Pedal Part

- 2 Press the [H-BAR MANUAL] button to make its indicator light.**

When the [H-BAR MANUAL] button’s indicator is dark, the harmonic bar settings will be the harmonic bar settings of the organ voice of the selected preset (p. 22, 45).

- 3 Move the harmonic bars to edit the sound (p. 24).**

A sound you’ve edited can be saved as a preset (p. 45).



To hear the sound of the Lower part, you can either select Split (p. 38) and play the sound of the Lower part in the left-hand zone of the keyboard, or connect an external keyboard (p. 59). To hear the sound of the pedal part, connect an external pedal keyboard (p. 59).

Adjusting the Sound in Real Time (Harmonic Bars)

The harmonic bars are controllers for creating the basic structure of the organ sound. By sliding nine harmonic bars in and out you can create a variety of tonalities.

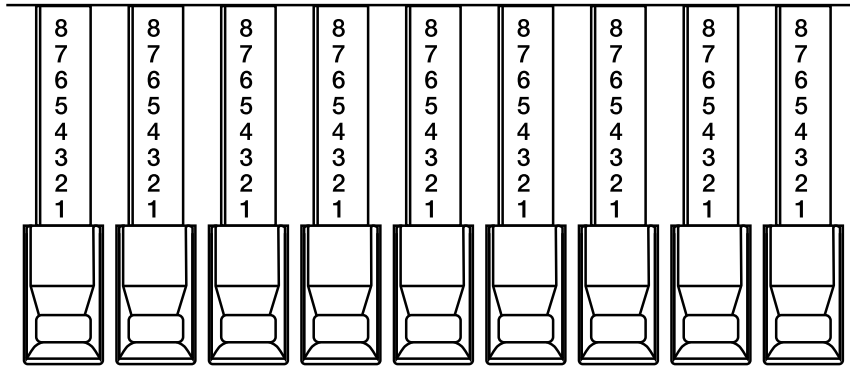

The numbers appearing on the harmonic bars allow you to rapidly set the bars to the desired setting. If you push a harmonic bar inward until no number is visible, its volume will be "0," and no sound will be heard. If you pull a harmonic bar all the way out, the volume will be at the maximum.

A sine wave (pure tone) of differing pitch is assigned to each of the harmonic bars, and you can create a variety of sounds by mixing these sine waves.

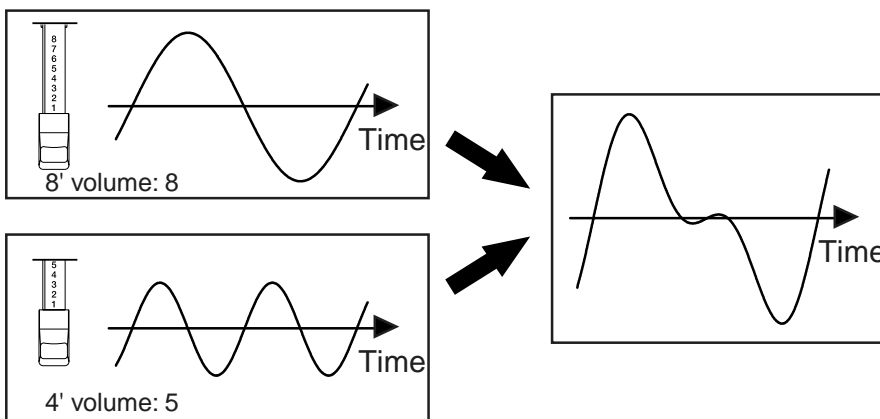





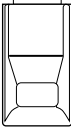
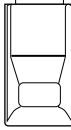
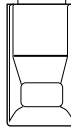
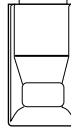
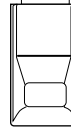

When percussion is on, the 1' pitch will not be produced.

The numbers (16', 5-1/3', etc.) printed on the knob of each harmonic bar indicate the pitch of that bar in "feet." The pitch of each harmonic bar plays an important role in creating the tone. The 8' pitch is the basic pitch of the sound, and the sound is created based on this 8' pitch.

The pitches of the harmonic bars are related as follows.

When the middle C (C4) note is pressed, each harmonic bar will sound the following notes.

8 7 6 5 4 3 2 1	8 7 6 5 4 3 2 1	8 7 6 5 4 3 2 1	8 7 6 5 4 3 2 1	8 7 6 5 4 3 2 1	8 7 6 5 4 3 2 1	8 7 6 5 4 3 2 1	8 7 6 5 4 3 2 1	8 7 6 5 4 3 2 1
								
16'	5 1/3'	8'	4'	2 2/3'	2'	1 3/5'	1 1/3'	1'
one octave below	5th	root	8th	12th	15th	17th	19th	22nd



What Are “Feet?”

Historically, the “feet” (“ ’ ” symbol) indications of the harmonic bars originate in the length of the pipes of a pipe organ. The length of pipe used to produce the reference pitch (the fundamental) for the keyboard is eight feet. Reducing the pipe to half its length produces a pitch one octave higher; conversely, doubling the pipe length creates a pitch one octave lower. Therefore, a pipe producing a pitch one octave below that of the reference of 8' (eight feet) would be 16'; for one octave above the reference, the pipe would be 4', and to take the pitch up yet another octave it would be shortened to 2'.

On tone wheel organs, the pitch relationship shown in the diagram does not hold true in a certain region of the keyboard (p. 25). In the high range of the keyboard, high-pitched feet are “wrapped around” one octave down. High footages will be “folded back” for high notes, while low footages will be folded back for low notes. Folding back the high-frequency portion prevents the high-frequency sounds from being unpleasantly shrill, and folding back the low-frequency portion prevents the sound from becoming “muddy.” On the VK-8 faithfully simulates this characteristic.

As you can see from the relation of the pitches, the 5-1/3' pitch is unique in that it is not arranged in order of pitch. The reason is that the 5-1/3' sound blends not with the 8' (fundamental), but with the 16' pitch. Acoustic instruments produce sound consisting of frequencies at integer multiples of the fundamental frequency; double, triple, and so on. These are called “integer harmonics.” Relative to the 8' pitch that is the basic pitch of an organ, the 5-1/3' pitch is not an integer multiple, and does not blend.

However, relative to the 16' pitch (which is one octave lower), 5-1/3' is an integer multiple and therefore does blend. (Starting at 16', the 5-1/3' pitch is three times higher.) Because 5-1/3' blends with 16', these two harmonic bars are colored differently than the other harmonic bars, and are placed together.

Changing the Organ Sound (Wheel Type, Leakage Level)

Tone Wheel and Leakage Noise are important elements in creating tone wheel organ sounds.

Tone wheel

Tone wheels are the ninety-one metal disks that produce the sound on tone wheel organs. Teeth are cut into the edge of each disk, and sound is generated by rotating the disks past an electrical coil at a fixed speed. The VK-8 digitally simulates the tone wheel mechanism of a tone wheel organ, and thus provides the rapid response and full polyphony that characterize these instruments.

The sounds that are produced by the tone wheels of a tone wheel organ are not precisely pure sine waves, since they are affected by the manufacturing precision of the wheel and by the characteristics of the analog circuitry. However, it is these imperfections in the waveform that give a tone wheel organ its unique character.

Leakage Noise

On tone wheel organs, the sound of the note that was pressed was slightly “contaminated” by audio signals from tone wheels not related to that note.

Formerly, this was seen as a problem, but today this idiosyncrasy is considered an important element of the distinctive sound of a vintage organ.

Tone Wheel type

Selects the type of tone wheel.

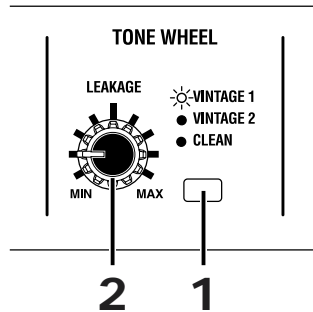

1 Press the [TONE WHEEL] button to select the type of tone wheel.

Each time you press the [TONE WHEEL] button, the tone wheel will switch between the following settings.

Type	Explanation
VINTAGE1	A tone wheel that simulates the tone wheel organs of the 70's.
VINTAGE2	A tone wheel that simulates the tone wheel organs of the 60's.
CLEAN	A tone wheel with no leakage noise.

Leakage Noise

Separately from the leakage noise selected by the Tone Wheel Type, you can add leakage noise independently.

2 Turn the [LEAKAGE] knob.

Turning the knob toward the left will decrease the volume of the leakage noise, and turning it toward the right will increase the volume of the leakage noise.

NOTE

If the “VINTAGE1” or “VINTAGE2” wheel type is selected, there will still be some leakage noise even if the [LEAKAGE] knob is turned all the way to the left.

Adding Crispness to the Sound (Percussion)

Percussion adds an attack-type sound to the beginning of the note to give the sound more crispness. When you play legato (smoothly and connectedly), percussion will be added only to the first-played note. When you play staccato (articulating each note separately), percussion will be added to all notes.

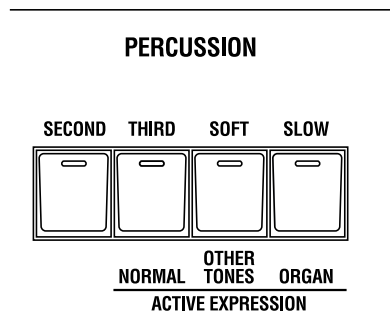

[SECOND] (Second Percussion) button

This button switches Second Percussion on/off.

Button	Explanation
<p style="text-align: center;">SECOND</p> <p style="text-align: center;">Lit (ON)</p>	Percussion will sound at the same pitch as the 4' harmonic bar.
<p style="text-align: center;">SECOND</p> <p style="text-align: center;">Dark (OFF)</p>	Second percussion will not sound.

[THIRD] (Third Percussion) button

This button switches Third Percussion on/off.

Button	Explanation
<p style="text-align: center;">THIRD</p> <p style="text-align: center;">Lit (ON)</p>	Percussion will sound at the same pitch as the 2-2/3' harmonic bar.
<p style="text-align: center;">THIRD</p> <p style="text-align: center;">Dark (OFF)</p>	Third percussion will not sound.



Percussion can be added only to the upper part of organ voices. It cannot be added to the lower part of organ voices, nor to the pedal part or other tones.





When percussion is on, the 1' pitch will not be produced.



It is not possible to select both [SECOND] and [THIRD] simultaneously.

[SOFT] (Soft Percussion) button

Switches the volume of the percussion.

Button	Explanation
<p>SOFT</p>  <p>Lit (ON)</p>	The percussion sound will be softer.
<p>SOFT</p>  <p>Dark (OFF)</p>	The percussion sound will be normal.

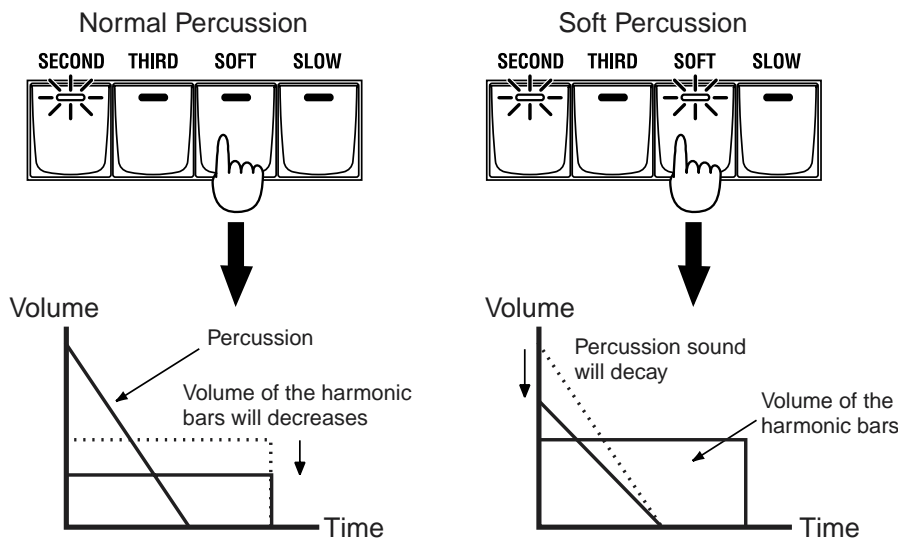

When you turn the [SOFT] button off to strengthen the percussion sound, the organ sound specified by the harmonic bars will become lower. This reproduces the behavior of tone wheel organs. If the organ volume decreases when you turn the [SOFT] button off, you can make settings (p. 52). You can also specify the percussion volumes that will be selected by the Percussion Normal/Soft settings (p. 51).



Playing the Organ

[SLOW] (Slow Percussion) button

Switches the speed at which the percussion sound will decay.

Button	Explanation
<p>SLOW</p>  <p>Lit (ON)</p>	<p>The percussion sound will disappear slowly. The percussion will have a more gentle attack.</p>
<p>SLOW</p>  <p>Dark (OFF)</p>	<p>The percussion sound will disappear quickly. The percussion will have a sharper attack.</p>



You can specify the speed at which the percussion sound decays (p. 51).

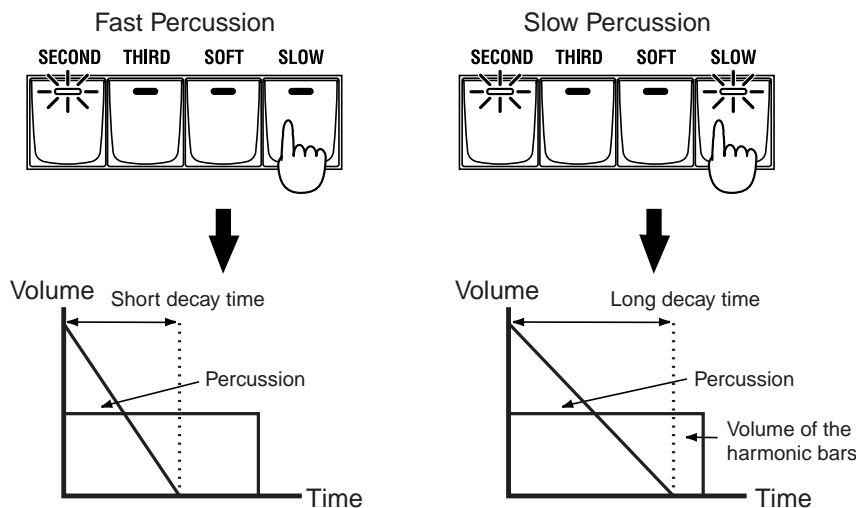

Percussion on a tone wheel organ (Single Trigger Algorithm)

The percussion on tone wheel organs did not apply to all notes that were played. It was applied only to notes which were played simultaneously from a condition where no notes were being played. When notes were played legato (smoothly and connectedly), percussion was applied only to the first-played note. When notes were played staccato (articulating each note separately), percussion was applied to all notes. This method is referred to as single trigger algorithm, and is a very important element in organ performance. On tone wheel organs, percussion was produced by an analog circuit. For this reason, when there was only a very short time interval from when one key was released until the next key was pressed, the percussion circuit was unable to recharge fully, causing the percussion to sound at a lower volume. The VK-8 simulates this behavior, and also allows you to modify the organ voice settings to adjust the recharge time characteristics of the circuit (p. 51).

Adding Modulation to the Sound (Vibrato and Chorus)

The vibrato effect cyclically modulates the pitch of organ voice sounds. The chorus effect mixes the normal sound of the organ with a sound to which vibrato has been applied, adding richness and spaciousness to the sound.

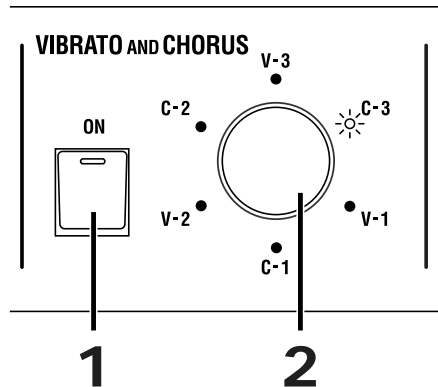

- 1 Press the VIBRATO AND CHORUS [ON] button to make its indicator light.**

The vibrato or chorus effect will be applied to the organ voice.

- 2 Turn the [VIBRATO AND CHORUS] knob to switch the type of vibrato or chorus effect.**

The indicator of the selected vibrato or chorus effect type will light.

Three types of vibrato and three types of chorus are provided (a total of six types).

V-1, V-2, V-3

This applies vibrato (pitch modulation). Increasing the value will produce a deeper effect.

C-1, C-2, C-3

This applies chorus to add depth and spaciousness to the sound. Increasing the value will produce a deeper effect.

NOTE

It is not possible to apply both vibrato and chorus simultaneously. Nor is it possible to select different vibrato or chorus types for the upper part and lower part.

NOTE

Vibrato or chorus cannot be applied to percussion.

Using the COSM Rotary Speaker Effect (Rotary Sound)

Rotary Sound is an effect which adds the modulation that is produced when organ voices are used with a rotary speaker. On most rotary speakers, the high-frequency speaker and low-frequency speaker rotate at different speeds. The VK-8 can simulate this type of complex modulation.

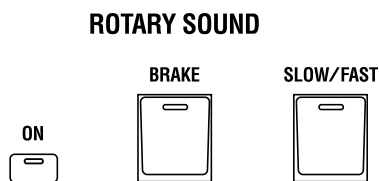



[SLOW/FAST] button

Switches the speed of the rotary speaker. FAST and SLOW will alternate each time you press the [SLOW/FAST] button.

FAST rotation is selected when the indicator blinks rapidly. SLOW rotation is selected when the indicator blinks slowly. When you change between slow/fast, the speed of rotation will change gradually.



[BRAKE] button

This button temporarily halts the rotation of the rotary sound.

Button	Explanation
<p>BRAKE</p>  <p>Lit (ON)</p>	The speed of rotation will gradually slow down and then stop.
<p>BRAKE</p>  <p>Dark (OFF)</p>	From a stopped condition, the rotation will gradually become faster.

ROTARY [ON] button

The rotary speaker effect can be switched off.

Button	Explanation
<p>ON</p>  <p>Lit (ON)</p>	The rotary speaker will be applied.
<p>ON</p>  <p>Dark (OFF)</p>	The rotary speaker effect will not be applied.

MEMO

The VK-8 uses an effect algorithm based on COSM technology, and is able to faithfully reproduce the modulation of an actual rotary speaker and the irregularities of its rotation. You can also make sophisticated settings, such as the characteristics of the amplifier (p. 33), the resonance of the speaker cabinet, and the distance of the microphone which picks up the sound of the rotary speaker (p. 50).

MEMO

You can use a foot switch or D Beam controller to switch the rotary speaker between fast and slow. For details, refer to "Using the D BEAM Controller to Produce Common Organ Effects" (p. 34) and "Assigning a Function to the Control Pedal" (p. 40).

MEMO

When a rotary speaker is connected to the ROTARY TONE CABINET jack on the rear panel, the rotary effect is not applied, and the [SLOW/FAST] button, [BRAKE] button, and ROTARY SOUND [ON] button function as follows.

ROTARY SOUND [ON] Button

Disabled when a rotary speaker is connected.

[SLOW/FAST] Button

Changes the speed of the connected rotary speaker.

[BRAKE] Button

Temporarily stops the rotation of the connected rotary speaker.

Changing the Amp Type (Amp Type, Overdrive, Tone)

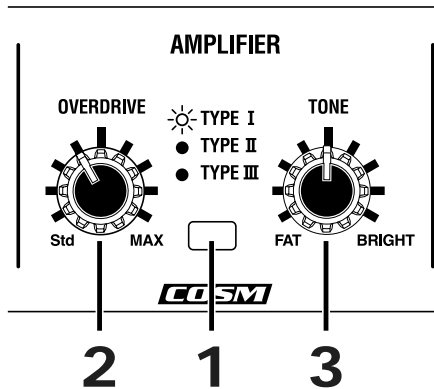

Changing the virtual amp

Switches the frequency response and cabinet resonance of the virtual amp.

1 Press the [AMPLIFIER] button to select the type of virtual amp.

The amp type will change each time you press the [AMPLIFIER] button. To select the “TYPE IV” virtual amp type, press the [AMPLIFIER] button several times until all of the AMP TYPE indicators are lit.

Type	Explanation
TYPE I	Characteristics of the most frequently used rotary speakers.
TYPE II	Characteristics of the large vacuum tube amps that were an indispensable element of the British hard rock of the 70's, and that continue to be favored by many hard rock guitarists.
TYPE III	The character of a rotary speaker often used for rock organ.
TYPE IV	This adds the characteristic rotary speaker sound used for a wide range of tones, from a clean sound to heavy overdrive. What's more, a new type of system is used that allows you to change the amount of overdrive without causing the volume to change, making level settings a breeze.

Adding distortion to the sound—Overdrive

Overdrive is an effect which distorts the sound. By distorting the sound, you can create the intense organ sounds that are frequently used in styles, such as hard rock.

2 Turn the [OVERDRIVE] knob to adjust the amount of overdrive.

Rotate fully right: The distortion effect will be at maximum.
 Rotate fully left: No effect.

Changing Sound Characters

You can adjust the tonal character of the organ voice.

3 Turn the [TONE] knob to adjust the tonal character.

Counterclockwise rotation: The organ voice becomes fatter.
 Clockwise rotation: The organ voice becomes brighter.

Using the D BEAM Controller to Produce Common Organ Effects

You can apply various effects to the sound only by moving your hand over the D Beam Controller on the VK-8 panel.

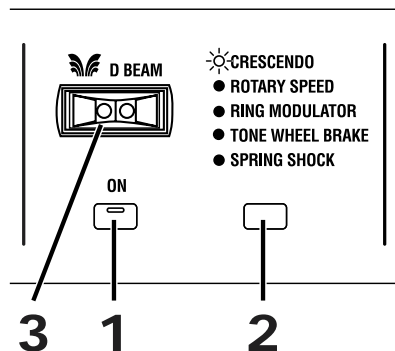

1 Press D BEAM [ON] button to make its indicator light.

The D Beam Controller will be on.

2 Use the D Beam button to select the effect that you want to control using the D Beam.

The effect assigned to the D Beam controller will be switched each time you press the [D BEAM] button.

The following effects can be applied using the D Beam controller:

Effects	Explanation
CRESCENDO	As you move your hand closer to the D Beam controller, the volume of all harmonic bars will gradually increase. When your hand is closest to the D Beam controller, the harmonic bar volumes will be at maximum, and the rotary will switch to FAST.
ROTARY SPEED	The rotary effect will switch between slow and fast each time you position your hand over the D Beam controller.
RING MODULATOR	When you position your hand over the D Beam controller, the ring modulator will be applied (p. 35). As you bring your hand closer to the D Beam controller, the ring modulator depth will change.
TONE WHEEL BRAKE	Moving your hand over the D Beam will turn on the wheel brake. When you take your hand away from the D Beam controller, the wheel brake will be turned off (p. 35).
SPRING SHOCK	Moving your hand near the D Beam controller will produce the sound of a spring reverb unit being jarred (p. 35).

MEMO

If ROTARY SPEED is assigned to the D Beam, you can move your hand over the D Beam to make the rotary effect change gradually from slow to fast, or from fast to slow (p. 57).

MEMO

The volume of the spring shock can be adjusted with the [REVERB] knob. The spring shock is particularly effective if "SPRING" is selected as the reverb type (p. 37).

- 3** While playing the keyboard to produce sound, place your hand over the D Beam controller.

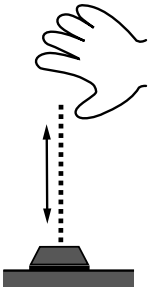

The timbre will change when you move your hand over the D Beam controller.

About the Effects

Throughout the history of rock organ, a wide range of performers have developed unique effects and used them in their music. The VK-8 can not only simulate several of these unique effects, but also lets you enjoy effects provided by no other instrument.

Giving the sound a metallic character (Ring Modulator)

By changing the frequency of the ring modulator's internal oscillator, you can give the organ voice an unpitched metallic character, like that of a bell.

In hard rock of the past, extreme effects such as ring modulation were sometimes applied to the organ. It appears that organ players tried all sorts of things in an attempt to hold their own against the radical performance techniques used by electric guitarists.

By applying ring modulation, you can create a complex harmonic structure that was not present in the original audio signal. This complex harmonic structure has a certain bell-like character. The term "ring" comes from the fact that when a ring modulation circuit is constructed as analog circuitry, the circuit is shaped like a ring (circle).

Stopping the rotation of the tone wheels (Wheel Brake)

It is possible to stop the rotation of the tone wheels of the organ. This produces an unexpected result, whereby the pitch of the organ voice gradually falls until the sound ceases entirely.

The technique of stopping the tone wheel rotation was occasionally used by performers on tone wheel organs. Since the amp of a tone wheel organ was an analog circuit that used vacuum tubes, the sound was still audible for a time after the power was turned off. However, when the power was turned off, the tone wheels would begin slowing down, and you would hear the pitch continue to fall. Innovative performers used this effect in their music.

Spring Reverb Shock

Organs of the past used spring reverb units to add a reverb effect to the sound. When a physical shock is applied to a spring reverb unit, the springs collide with each other, producing a crashing sound. Some performers even utilized this in their organ sound.

The VK-8 lets you simulate this reverb impact sound.



When the D Beam controller is responding, the D Beam [ON] button's indicator will blink.



When the "SPRING SHOCK" function is assigned to the D Beam controller or the control pedal, please be aware that raising the reverb level excessively will produce a high-volume impact sound. If you want to reduce the volume of the impact sound, use the [REVERB] knob to adjust the reverb level (p. 37).

■ Adjusting the Sensitivity of the D Beam Controller

The VK-8 automatically calibrates the sensitivity of the D Beam controller each time power is turned on. You can also adjust the sensitivity of the D Beam controller after the power is turned on.

Caution

The VK-8 automatically calibrates the sensitivity of the D Beam controller each time power is turned on. For this reason, when turning on the power, make sure no object is placed on the D Beam, and avoid having your hands near it.

Also, please be aware that the D Beam will not function in a location where there is a large amount of infrared light.

Automatically adjusting the sensitivity of the D Beam controller

- 1 While holding down the D BEAM [ON] button, press the VIBRATO AND CHORUS [ON] button.

The sensitivity of the D Beam controller will be adjusted automatically.

The D Beam indicators will show the D Beam sensitivity.

● CRESCENDO ● ROTARY SPEED ● RING MODULATOR ● TONE WHEEL BRAKE ● SPRING SHOCK	● CRESCENDO ● ROTARY SPEED ● RING MODULATOR ● TONE WHEEL BRAKE ☼ SPRING SHOCK	● CRESCENDO ● ROTARY SPEED ● RING MODULATOR ☼ TONE WHEEL BRAKE ☼ SPRING SHOCK	● CRESCENDO ● ROTARY SPEED ☼ RING MODULATOR ☼ TONE WHEEL BRAKE ☼ SPRING SHOCK	● CRESCENDO ☼ ROTARY SPEED ☼ RING MODULATOR ☼ TONE WHEEL BRAKE ☼ SPRING SHOCK	☼ CRESCENDO ☼ ROTARY SPEED ☼ RING MODULATOR ☼ TONE WHEEL BRAKE ☼ SPRING SHOCK
---	---	---	---	---	---

Min Max

Manually adjusting the sensitivity of the D Beam controller

- 1 While holding down the D BEAM [ON] button, turn the [VIBRATO AND CHORUS] knob to adjust the sensitivity of the D Beam controller.



Since the sensitivity of the D Beam controller is adjusted automatically when the power is turned on, the sensitivity of the D Beam controller is not stored internally.

Adding Ambience (Reverb)

Reverb is an effect that adds reverberation to the sound. You can apply the reverb effect to the organ sound and the Other Tone.

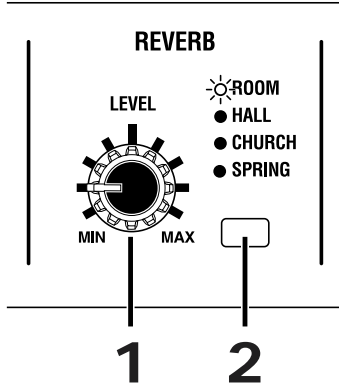

- 1 Turn the [REVERB] knob to adjust the amount of reverb effect to be applied.

Rotate fully right: Maximum reverberation.

Rotate fully left: No effect.

Changing the Reverb Type

By changing the reverberations of the notes, you can enjoy the atmosphere of performance in a wide variety of different locations.

- 2 Press the [REVERB] button to switch the reverb types.

The reverb type will be switched each time you press the [REVERB] button.

Type	Explanation
ROOM	Simulates the reverberation of a room.
HALL	Simulates the reverb of a large concert hall.
CHURCH	Simulates the reverberation of a church.
SPRING	Simulates the reverberation of a spring reverb unit (p. 35).

NOTE

When the “SPRING SHOCK” function is assigned to the D Beam controller or the control pedal, please be aware that raising the reverb level excessively will produce a high-volume impact sound (p. 34, p. 40).

MEMO

If the “SPRING REVERB SHOCK” function is assigned to the D Beam controller or the control pedal, be aware that excessively high reverb level settings will produce a high-volume impact sound. To decrease the volume of the impact sound, use the [REVERB] knob to adjust the reverb level (p. 34, p. 40).

Dividing the Keyboard (Split)

You can divide the keyboard into two zones, and assign the upper part sound of the organ voice to the right-hand zone, and the lower part sound of the organ voice to the left-hand zone.

This is called “split,” and the location at which the keyboard is divided is called the “split point.” The split point is included in the Upper part.

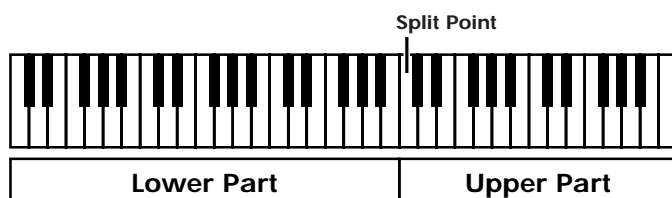

At the factory settings, the split point is set to “C4” (middle C).

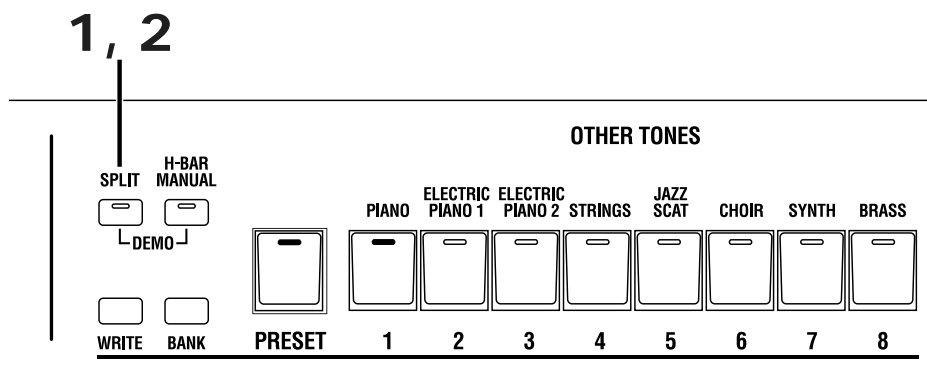

1 Press the [SPLIT] button to make its indicator light.

The keyboard will be divided into two zones.

The right-hand keyboard zone will play the Upper organ part, and the left-hand keyboard zone will play the Lower organ part.

2 To cancel the Split, press the [SPLIT] button once again, extinguishing the indicator.

■ Changing the Split Point

You can change the location (Split Point) at which the keyboard will be divided.

1 Hold down the HARMONIC BAR PART [UPPER] and [PEDAL] buttons and press the [SPLIT] button.

2 Press the key that you want to specify as the split point.

3 Press the [WRITE] button to finalize the split point.

The split point will be set.



You are free to change the split point.



When you hold down the HARMONIC BAR PART [UPPER] and [PEDAL] buttons and press the [SPLIT] button, the [SPLIT] button and the [1]–[3] buttons will blink. At this time, press one of the [1]–[3] buttons to select the part that will play Other Tones (p. 57).

Using the Expression Pedal

You can connect an expression pedal to the rear panel EXPRESSION PEDAL jack and use it to adjust the volume. Advancing the pedal away from yourself will increase the volume, and returning it toward yourself will decrease the volume.

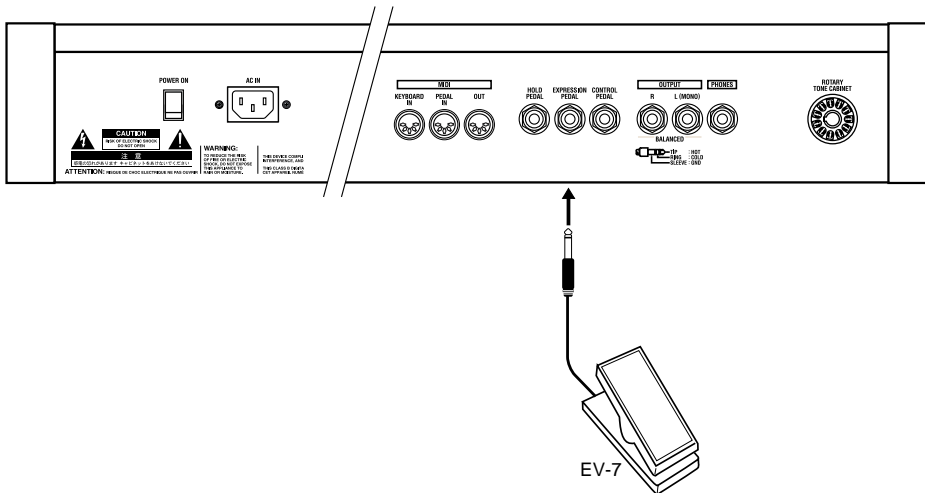

■ Using the Active Expression Function

Normally, when you use an expression pedal connected to the EXPRESSION PEDAL jack, the Organ Voice and Other Tones will both gradually change in volume. The VK-8 provides an Active Expression function, which you can use with an expression pedal connected to the EXPRESSION PEDAL jack. The Active Expression function lets you create tonal changes for greater expressiveness, and allows you to emphasize the “forte” passages in your playing.

The VK-8 has two types of Active Expression settings.

○ Applying the Active Expression Function to the Organ Voice

When you step on the expression pedal lightly, the Other Tones will sound. Depress the pedal further to get the footage of the harmonic bars to gradually change.

- 1 Hold down the HARMONIC BAR PART [UPPER] and [PEDAL] buttons, and press the PERCUSSION [SLOW] button.

○ Applying the Active Expression Function to the Other Tones

When you step on the expression pedal lightly, the organ voice will sound. Depress the pedal some more, and the Other Voice will be added.

- 1 Hold down the HARMONIC BAR PART [UPPER] and [PEDAL] buttons and press the PERCUSSION [SOFT] button.

○ Returning to the Normal Expression Pedal Function

- 1 Hold down the HARMONIC BAR PART [UPPER] and [PEDAL] buttons and press the PERCUSSION [THIRD] button.



Even if you return the expression pedal all the way toward yourself, the organ volume will not go to zero.



Settings for the Active Expression function can be stored for each preset (p. 39).

Using a Control Pedal

You can connect a pedal switch or expression pedal to the rear panel CONTROL PEDAL jack, and assign a function to the pedal.

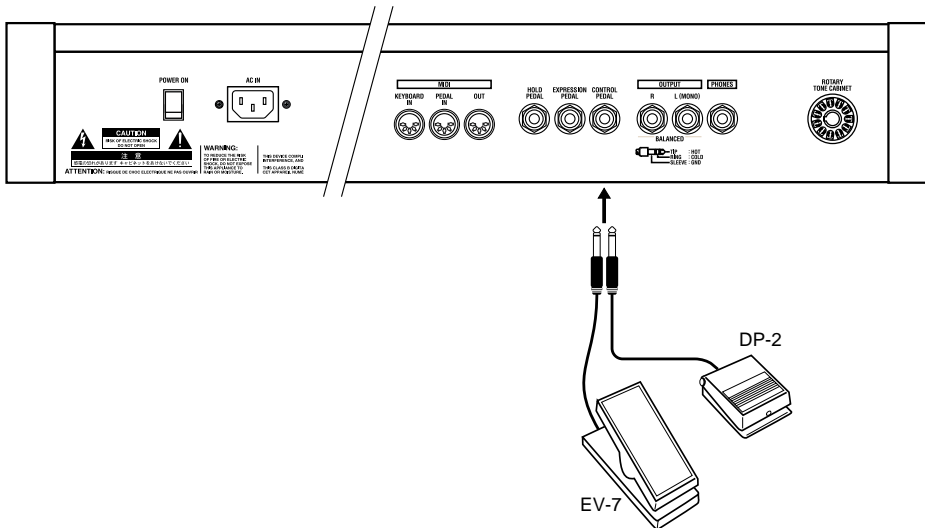

NOTE

For some type of pedal switch, the action you obtain when the pedal is pressed will be the opposite of what you intend. In this case, change the polarity of the pedal (p. 56).

■ Assigning a Function to the Control Pedal

You can change the function that is assigned to the control pedal.

- 1 Hold down the HARMONIC BAR PART [UPPER] and [PEDAL] buttons and press the ROTARY [SLOW/FAST] button.**

The indicators of buttons [1]–[8] will blink.

- 2 Press one of the buttons from [1] through [8] to select the function that you want to assign to the control pedal.**

12 different functions can be assigned to the control pedal. You can select any one of these functions by switching the indicator of the [PRESET] button between lit/dark states.

The following parameters are assigned to each button.

[PRESET] button's indicator is dark

Button	Parameter	Page
[1]	ROTARY SLOW/FAST	The rotary speaker effect can be switched between slow and fast. This will have the same effect as the [SLOW/FAST] button.
[2]	ROTARY SPEED	The speed of the rotary speaker effect can be freely controlled between slow and fast. This is especially effective when assigned to the expression pedal.
[3]	ROTARY BRAKE	This button temporarily halts the rotation of the rotary sound.

Button	Parameter	Page
[4]	OTHER TONES GLIDE	Controls the Glide function for the Other Tones. The pitch of the Other Tones will change while the pedal is pressed, and will gradually return to the original pitch when the pedal is released.
[5]	PRESET UP	Steps sequentially through the presets. Each time the pedal is pressed, the next registration will be selected.
[6]	OVERDRIVE	The depth of overdrive will be controlled. This is especially effective when assigned to the expression pedal.
[7]	OTHER TONES EXPRESSION	Select this when you want to use the expression pedal to control the volume of the Other Tones. While this function is being used, the expression pedal connected to the EXPRESSION PEDAL jack will affect only the volume of the organ.
[8]	D BEAM SYNC	The same function that is assigned to the D BEAM controller will also be assigned to the control pedal. When you change the function that is assigned to the D BEAM controller, the function that is assigned to the control pedal will also change.

[PRESET] button's indicator is lit

Button	Parameter	Page
[1]	CRESCENDO	As you depress the pedal connected to the EXPRESSION PEDAL jack, the volume of all harmonic bars will gradually become louder. When the pedal is fully depressed, the volume will be as specified by the harmonic bars, and the rotary will be in the FAST state. As you return the pedal toward yourself, the volume will decrease, and when the expression pedal is returned all the way toward yourself, there will be no sound.
[2]	RING MODULATOR	When you depress the pedal, the ring modulator (p. 35) will be applied. The depth to which you depress the pedal will control the depth of the ring modulator.
[3]	TONE WHEEL BRAKE	The wheel brake will be applied (p. 35).
[4]	SPRING SHOCK	This lets you produce the sound of a spring reverb unit being jarred (p. 35).

If you want to stop editing, press the HARMONIC BAR PART [UPPER] button.

3 Press the [WRITE] button to finalize the function assigned to the control pedal.

The function assigned to the control pedal will be saved.

While the settings are being saved, the [1]–[8] buttons will blink.

NOTE

When the “SPRING SHOCK” function is assigned to the D Beam controller or the control pedal, please be aware that raising the reverb level excessively will produce a high-volume impact sound. If you want to reduce the volume of the impact sound, use the [REVERB] knob to adjust the reverb level (p. 37).

MEMO

If you press the VIBRATO AND CHORUS [ON] button, the setting will return to its initial value.

NOTE

Never turn off the power while the settings are being saved.

Using the Hold Pedal to Sustain the Sound

If you connect a pedal switch to the rear panel HOLD PEDAL jack, the organ voice or other tone that you play while pressing the pedal will be sustained. This is the same function as the damper pedal of a piano.

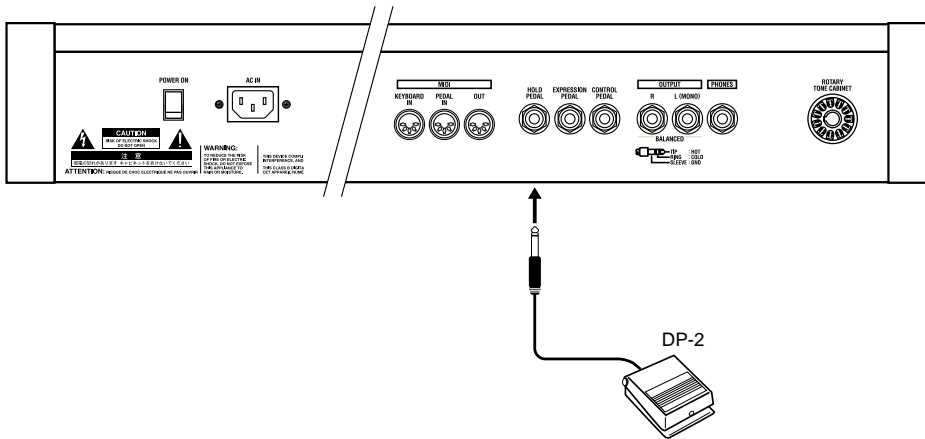

NOTE

For some type of pedal switch, the action you obtain when the pedal is pressed will be the opposite of what you intend. In this case, change the polarity of the pedal (p. 56).

MEMO

You can also set it so the Hold Pedal function will apply only to OTHER TONES (p. 57).

Playing Other Tones

Layering Other Tones with Organ Sounds (Layer)

In addition to organ voices, the VK-8 provides OTHER TONES, such as piano or strings. Here's how you can play organ sounds together with other tones.

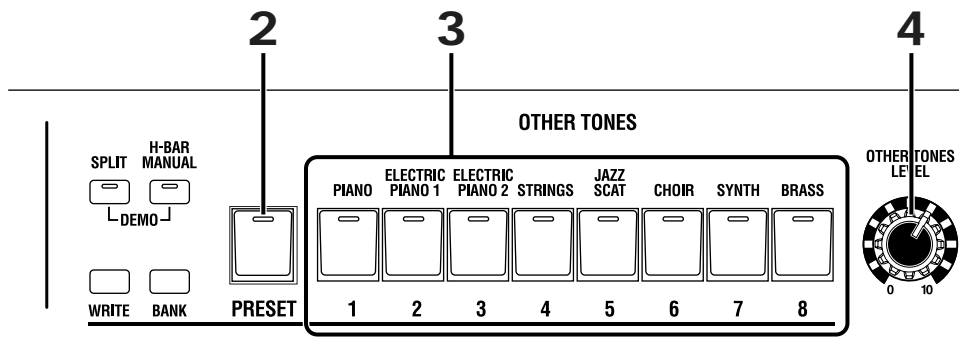

- 1** Select a preset organ voice (p. 22), or use the harmonic bars and other knobs and buttons to create the desired organ sound.
- 2** Press the [PRESET] button, extinguishing its indicator.
- 3** Press one of the buttons from [1] through [8] to select an Other Tone.

The selected Other Tone will sound together with the organ voice.

Button	Tone
[1]	PIANO
[2]	ELECTRIC PIANO 1
[3]	ELECTRIC PIANO 2
[4]	STRINGS
[5]	JAZZ SCAT
[6]	CHOIR
[7]	SYNTH (Synthesizer)
[8]	BRASS

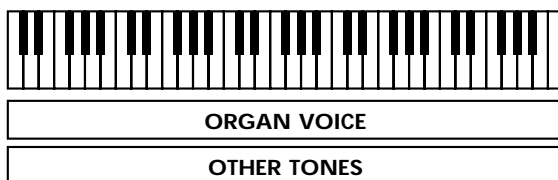

- 4** Turn the [OTHER TONES LEVEL] knob to adjust the volume of the OTHER TONES.

MEMO

When the [PRESET] button's indicator is lit, the [1]–[8] buttons will select presets (p. 22).

Assigning Organ Sounds and Other Tones Across the Keyboard (Split)

When the Organ Voice and Other Tones are layered together, you can press the [SPLIT] button to divide the keyboard into two zones, splitting the organ voice.

The organ voice will sound the Upper part in the right-hand zone, and the Lower part in the left-hand zone. Other Tones will be layered with the Upper part.

1 Select a preset organ voice (p. 22), or use the harmonic bars and other knobs and buttons to create the desired organ sound.

2 Press the [PRESET] button, extinguishing its indicator.

3 Press one of the buttons from [1] through [8] to select an Other Tone.

The selected Other Tone will sound together with the organ voice.

4 Press the [SPLIT] button.

The organ voice will be divided into upper and lower. The Other Tone will sound in the upper area.

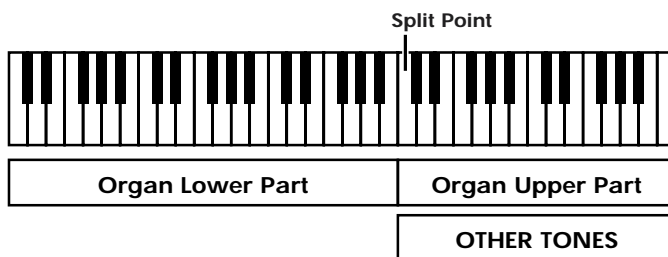

You can change the part that plays the Other Tones (p. 57).

○ **Playing the Other Tone in the upper, and the organ voice in the lower part**

5 Press the HARMONIC BAR PART [UPPER] button to make its indicator light.

6 Press the harmonic bars inward until you can no longer see the numbers.

7 Get the indicators for the PERCUSSION [SECOND] button and PERCUSSION [THIRD] button to go out (off).

The lower part of the organ voice will sound in the lower area, and only the Other Tone will sound in the upper area.

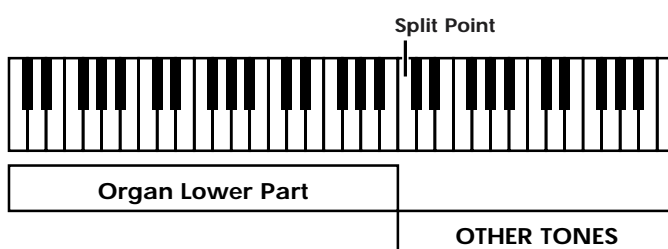

Saving Your Settings (Preset)

Organ sounds, Other Tones sounds, and other panel settings can be saved together to a [PRESET] button. By saving your favorite settings in a preset, you can easily recall them simply by pressing a [PRESET] button.

The VK-8 contains 64 different presets. These are organized into eight groups, with eight presets in each group.

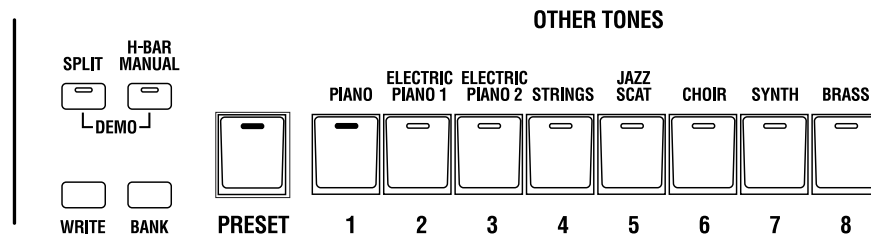

A preset contains the following settings.

- The sounds of the Upper part, Lower part, and Pedal part of the Harmonic Bar settings.
- ROTARY [ON] button
- ROTARY [BRAKE] button
- ROTARY [SLOW/FAST] button
- [TONE WHEEL] button
- [LEAKAGE] knob
- [AMPLIFIER] button
- [OVERDRIVE] knob
- [TONE] knob
- [REVERB] button
- REVERB [LEVEL] knob
- PERCUSSION [SECOND] button
- PERCUSSION [THIRD] button
- PERCUSSION [SOFT] button
- PERCUSSION [SLOW] button
- VIBRATO AND CHORUS [ON] button
- [VIBRATO AND CHORUS] knob
- D BEAM [ON] button
- [D BEAM] button
- [SPLIT] button
- OTHER TONES [1]–[8] button
- [OTHER TONES LEVEL] knob
- Effects and other settings (p. 56)
- Split Point (p. 38)
- OTHER PART ASSIGN setting (p. 57)
- Active Expression Settings (p. 39)



The VK-8 comes with 64 presets stored onboard. When you save a preset, the preset data that was previously occupying that memory number will be overwritten. Presets that you've overwritten can also be restored to the factory settings (p. 20).

Saving Your Settings (Preset)

■ Saving to a Preset in the Same Bank

- 1** Make the panel settings that you want to save in the preset.
- 2** Hold down the [WRITE] button, and press one of the buttons from [1] through [8] to specify the save-destination preset.
While the preset is being saved, the indicator of the selected preset number button will blink. Once the preset has been saved, the indicator will change from blinking to lit.

■ Saving to a Preset in Another Bank

- 1** Make the panel settings that you want to save in the preset.
- 2** Hold down the [WRITE] button, and press the [BANK] button and one of the buttons from [1] through [8].
The save-destination bank will be selected.
- 3** Hold down the [WRITE] button and press one of the buttons from [1] through [8] to specify the save-destination preset.
While the preset is being saved, the indicator of the selected preset number button will blink. When the preset has been saved, the indicator will change from blinking to lit.

■ Copying a preset

Selecting the copy-source preset

- 1** Press the [PRESET] button to make its indicator light.
- 2** Hold down the [BANK] button and press one of the buttons from [1] through [8] to select the bank of the copy-source preset.
- 3** Press one of the buttons from [1] through [8] to select the number of the copy-source preset.
The indicator of the number button you selected will light.

Selecting the copy-destination preset

- 4** Hold down the [WRITE] button and [BANK] button, and press one of the buttons from [1] through [8] to specify the bank of the copy-destination preset.
The indicator of the number button you selected will light.
- 5** Hold down the [WRITE] button and press one of the buttons from [1] through [8] to select the copy-destination preset number.
While the preset is being saved, the indicator of the selected preset number will blink. When the preset has been saved, the indicator will change from blinking to lit.

NOTE

Never turn off the power while a preset is being saved. Doing so may damage the unit.

NOTE

Never turn off the power while a preset is being saved. Doing so may damage the unit.

MEMO

The indicator of the selected bank will light while you hold down the [BANK] button.

MEMO

If you want to save the settings in a preset of the same bank, step 4 is not necessary.

NOTE

Never turn off the power while a preset is being saved. Doing so may damage the unit.

Advanced Use

Edit mode allows you to get the most out of the VK-8's functions by making more detailed settings. This section explains the functions that can be set in Edit mode. In this owner's manual, the process of modifying a setting is referred to as "editing," and the item of data that is modified is referred to as a "parameter."

■ About the Edit Modes

There are two edit modes—one saves settings individually for each preset, while the other stores a single value to be used by the entire system.

System Memory

The edit mode that stores things for the entire system deals with the following:

- Organ rotary settings (p. 49)
- Click noise and percussion settings (p. 51)
- MIDI settings (p. 52)
- Equalizer and other settings (p. 55)
- Control pedal settings (p. 40)

Preset Memory

The edit mode that stores things on an individual preset basis deals with the following:

- Effect and other settings (p. 56)
- Harmonic bars and other panel settings (p. 45)
- Split Point (p. 38)
- Active Expression setting (p. 39)
- OTHER TONES PART ASSIGN (p. 57)

NOTE

In the case of settings that are saved for each preset, you must save the edited settings in a preset. If you turn off the power without saving the edited settings to a preset, your changes will be lost.

■ Basic Procedure

Here is the basic procedure for each edit mode.

→ For details, refer to the explanation for each edit mode.

- 1. Hold down the HARMONIC BAR PART [UPPER] and [PEDAL] buttons, and press the [***] button.**

The indicators of the [1]–[8] buttons will blink.

MEMO

The [***] button will be a different button depending on the edit mode that you want to set. For details, follow the procedure for each edit mode.

- 2. Press one of the buttons from [1] through [8] to select the parameter that you want to edit.**

If there are more than eight parameters, you can access all of them by switching the lit/dark state of the [PRESET] button.

- 3. Turn the [VIBRATO AND CHORUS] knob to adjust the setting.**

For parameters that are switched ON/OFF, turn the [VIBRATO AND CHORUS] knob toward the right to switch the parameter ON, or toward the left to switch it OFF.

For parameters that have an adjustable value, turn the [VIBRATO AND CHORUS] knob toward the right to increase the value, or toward the left to decrease the value.

At this time, the D Beam type indicator will show the approximate value of the setting (p. 48).

MEMO

If you press the VIBRATO AND CHORUS [ON] button, the setting will return to the initial value.

- 4. If you want to adjust another parameter in the same edit mode, press one of the [1]–[8] buttons to select the parameter, and turn the [VIBRATO AND CHORUS] knob to edit the value.**

When you want to stop editing, press the HARMONIC BAR PART [UPPER] button.

- 5. Press the [WRITE] button to finalize the settings of the parameters.**

Parameter settings will be saved.

While the parameters are being saved, the indicators of the [1]–[8] button will blink.

- 6. Parameters that are edited independently for each preset are saved as part of the preset (p. 45).**

Advanced Use

State of the D BEAM Indicators in Edit Mode

○ When the setting is "0-127," "0-10," or "0-15," "0-31."

The minimum value (0) will be when the D Beam indicators are all dark, and the maximum value when they are all lit. As you increase the value, the D Beam indicators will successively light from the bottom.

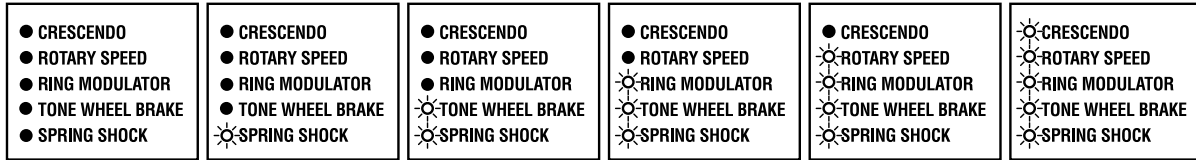

Min **Max**

The setting will increase as you turn the [VIBRATO AND CHORUS] knob clockwise, and will decrease as you turn it counterclockwise.

When you press the VIBRATO AND CHORUS [ON] button, this will return to the default setting.

○ If the setting is an "ON or OFF" switch

This will be OFF (0) when all D Beam indicators are dark, and ON when they are all lit.

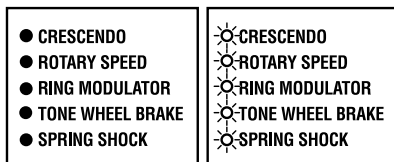

OFF **ON**

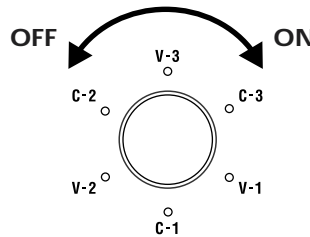

This will be ON when the [VIBRATO AND CHORUS] knob is turned to the right, and OFF when turned to the left.

When you press the VIBRATO AND CHORUS [ON] button, this will return to the default setting.

○ When the setting is "-5-0-+5," "-6-0-+5," "-100-0-+100," or "-3-0-+3"

The lit location of the D Beam Type indicator shows the approximate value.

When the value is 0, the center D Beam Type indicator (RING MODULATOR indicator) will light.

D Beam Type indicators below the middle will indicate a negative value, and D Beam Type indicators above the middle will indicate a positive value.

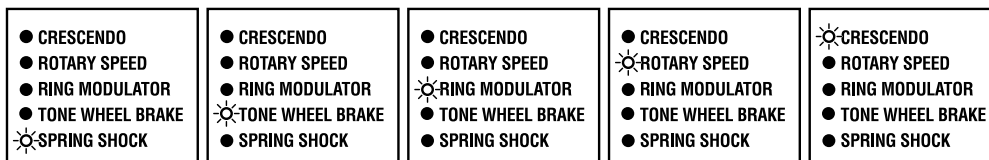

Min **0** **Max**

Turn the [VIBRATO AND CHORUS] knob clockwise to increase the value, or counterclockwise to decrease it.

When you press VIBRATO AND CHORUS [ON], this will return to the default setting.

Settings That Are Saved for the Entire System

■ Rotary-related Settings

1. Hold down the HARMONIC BAR PART [UPPER] and [PEDAL] buttons and press the [TONE WHEEL] button.

The indicators of the buttons [1]–[8] will blink.

2. Press one of the buttons from [1] through [8] to select the parameter that you want to edit.

There are 14 rotary-related parameters. You can select all of these parameters by controlling the lighted/extinguished state of the [PRESET] button's indicator.

The following parameters are assigned to each button.

[PRESET] button's indicator extinguished

Button	Parameter	Page
[1]	ROTARY WOOFER LEVEL	p. 50
[2]	ROTARY TWEETER LEVEL	p. 50
[3]	ROTARY WOOFER RISE TIME	p. 50
[4]	ROTARY TWEETER RISE TIME	p. 50
[5]	ROTARY WOOFER FALL TIME	p. 50
[6]	ROTARY TWEETER FALL TIME	p. 50
[7]	ROTARY WOOFER SPREAD	p. 50
[8]	ROTARY TWEETER SPREAD	p. 50

[PRESET] button's indicator lighted

Button	Parameter	Page
[1]	ROTARY WOOFER SPEED SLOW	p. 50
[2]	ROTARY TWEETER SPEED SLOW	p. 50
[3]	ROTARY WOOFER SPEED FAST	p. 50
[4]	ROTARY TWEETER SPEED FAST	p. 50
[5]	ROTARY MIC DISTANCE	p. 50
[6]	ROTARY RANDOMIZE	p. 50

3. Turn the [VIBRATO AND CHORUS] knob to adjust the setting.

MEMO

If you press the VIBRATO AND CHORUS [ON] button, the setting will return to the initial value.

4. If you want to adjust the setting of another parameter, press the appropriate button from [1] through [8] to select the parameter, and turn the [VIBRATO AND CHORUS] knob to adjust the setting.

When you want to stop editing, press the HARMONIC BAR PART [UPPER] button.

5. Press the [WRITE] button to finalize the settings of the rotary-related parameters.

Parameter settings will be saved.

While the parameters are being saved, the indicators of the [1]–[8] buttons will blink.

NOTE

Never turn off the power while parameters are being saved.

Advanced Use

○ ROTARY WOOFER LEVEL (0-127)

Specifies the volume of the low-range speaker (woofer).
The rotary speaker effect consists of a low range and a high range, and you can independently adjust the volume of the low-range speaker (woofer) and the high-range speaker (tweeter) to set as desired.

○ ROTARY TWEETER LEVEL (0-127)

Specifies the volume of the high-range speaker (tweeter).
The rotary speaker effect consists of a low range and a high range, and you can independently adjust the volume of the low-range speaker (woofer) and the high-range speaker (tweeter) to set as desired.

○ ROTARY WOOFER RISE TIME (0-127)

This specifies the speed at which the rotary speaker effect for the low-range (woofer) will shift from slow to fast. The change will occur more rapidly as this value is increased.

○ ROTARY TWEETER RISE TIME (0-127)

This specifies the speed at which the rotary speaker effect for the high-range (tweeter) will shift from slow to fast. The change will occur more rapidly as this value is increased.

○ ROTARY WOOFER FALL TIME (0-127)

Specifies the rate at which the low-range speaker (woofer) will change from the fast to the slow speed.
The change will occur more rapidly as this value is increased.

○ ROTARY TWEETER FALL TIME (0-127)

Specifies the rate at which the high-range speaker (tweeter) will change from the fast to the slow speed.
The change will occur more rapidly as this value is increased.

MEMO

The ROTARY RISE TIME / ROTARY FALL TIME parameters affect not only the change produced by the [SLOW/FAST] button, but also the rate at which the [BRAKE] button will stop or resume rotation.

○ ROTARY WOOFER SPREAD (0-10)

Specify the spaciousness of the low-range speaker (woofer).
Specifies the left/right spread of the rotary speaker. Increasing this value will increase the sense of stereo.

○ ROTARY TWEETER SPREAD (0-10)

Specify the spaciousness of the high-range speaker (tweeter).
Specifies the left/right spread of the rotary speaker. Increasing this value will increase the sense of stereo.

○ ROTARY WOOFER SPEED SLOW (0-127)

Specifies the rotational speed for the Slow setting of the rotary speaker. Specifies the rotational speed for the low-range speaker (woofer). Increasing the value raises the speed.

○ ROTARY TWEETER SPEED SLOW (0-127)

Specifies the rotational speed for the Slow setting of the rotary speaker. Specifies the rotational speed for the high-range speaker (tweeter). Increasing the value raises the speed.

○ ROTARY WOOFER SPEED FAST (0-127)

Specifies the rotational speed for the Fast setting of the rotary speaker. Specifies the rotational speed for the low-range speaker (woofer).
Increasing the value raises the speed.

○ ROTARY TWEETER SPEED FAST (0-127)

Specifies the rotational speed for the Fast setting of the rotary speaker. Specifies the rotational speed for the high-range speaker (tweeter).
Increasing the value raises the speed.

○ ROTARY MIC DISTANCE (0-10)

Specifies the distance from the rotary speaker to the mic. As this value is increased, the mic and speaker will be located further apart, and the volume will be modulated less.

○ ROTARY RANDOMIZE (0-10)

Adjusts the irregularity in the rotation of the rotary speaker. Increasing this value will produce more irregularity in the rotation.

■ Click Noise and Percussion Settings

1. Hold down the HARMONIC BAR PART [UPPER] and [PEDAL] buttons and press the PERCUSSION [SECOND] button.

The indicators of buttons [1]–[8] will blink.

2. Press one of the buttons from [1] through [8] to select the parameter that you want to edit.

There are eight parameters related to Click Noise and Percussion.

The following parameters are assigned to each button.

Button	Parameter	Page
[1]	ON CLICK LEVEL	p. 51
[2]	OFF CLICK LEVEL	p. 51
[3]	PERCUSSION SOFT LEVEL	p. 51
[4]	PERCUSSION NORMAL LEVEL	p. 51
[5]	PERCUSSION SLOW TIME	p. 51
[6]	PERCUSSION FAST TIME	p. 51
[7]	PERCUSSION RECHARGE TIME	p. 51
[8]	PERCUSSION H-BAR LEVEL	p. 52

3. Turn the [VIBRATO AND CHORUS] knob to adjust the setting.

MEMO

If you press the VIBRATO AND CHORUS [ON] button, the setting will return to its initial value.

4. If you want to edit another parameter, press the appropriate button from [1] through [8] to select the parameter, and turn the [VIBRATO AND CHORUS] knob to adjust the setting.

When you want to stop editing, press the HARMONIC BAR PART [UPPER] button.

5. Press the [WRITE] button to finalize the settings of the click noise and percussion parameters.

Parameter settings will be saved.

While the parameters are being saved, the [1]–[8] buttons will blink.

NOTE

Never turn off the power while parameters are being saved.

○ ON CLICK LEVEL (0–31)

Specifies the level of the click sound that occurs when a key is pressed (On). Increasing this value will increase the volume.

○ OFF CLICK LEVEL (0–31)

Specifies the level of the click sound that occurs when a key is released (Off). Increasing this value will increase the volume.

○ PERCUSSION SOFT LEVEL (0–15)

Sets the percussion volume when percussion is set to Soft (the [SOFT] button's indicator is lit). Increasing this value will increase the volume of percussion.

○ PERCUSSION NORMAL LEVEL (0–15)

Sets the percussion volume when percussion is set to Normal (the [SOFT] button's indicator is dark). Increasing this value will increase the volume of percussion.

○ PERCUSSION SLOW TIME (0–127)

Sets the speed at which the percussion sound will decay when percussion is set to Slow (the [SLOW] button's indicator is lit). Increasing this value causes the percussion to decay more slowly.

○ PERCUSSION FAST TIME (0–127)

Sets the speed at which the percussion sound will decay when percussion is set to Fast (the [SLOW] button's indicator is dark). Increasing this value causes the percussion to decay more slowly.

○ PERCUSSION RECHARGE TIME (0–10)

Specifies the percussion charge time that determines the time from when the keys are released until percussion is recharged. Increasing this value will increase the time necessary for percussion to recharge, causing the percussion sound to be smaller for rapidly repeated notes.

On tone wheel organs, percussion was produced by an analog circuit. This meant that if only a very short time elapsed from when the keys were released until the next key was pressed, the percussion circuit was unable to recharge fully, and the percussion sound that was added would therefore be lower in volume. This also meant that even if legato was broken during a rapid trill, etc., an appropriate amount of percussion was added. The percussion charge time parameter adjusts this charge time.

○ PERCUSSION H-BAR LEVEL (0–127)

Adjusts the volume of the harmonic bars when percussion is normal (the [SOFT] button's indicator is dark). As this value is increased, the sound of the harmonic bars will be less affected by the percussion.

On tone wheel organs, turning the percussion on would lower the overall volume specified by the harmonic bars. This is because the percussion on tone wheel organs was designed not to impair the volume balance of the entire organ. The VK-8 allows you to adjust this change in volume balance.

■ MIDI-related Settings

○ When setting things other than the MIDI channel

1. Hold down the HARMONIC BAR PART [UPPER] and [PEDAL] buttons and press the [REVERB] button.

The indicators of buttons [1]–[8] will blink.

2. Press one of the buttons from [1] through [8] to select the parameter that you want to edit.

There are 13 MIDI-related parameters. You can select all of these parameters by controlling the lighted/extinguished state of the [PRESET] button's indicator.

The following parameters are assigned to each button.

[PRESET] button's indicator extinguished

Button	Parameter	Page
[1]	LOCAL CONTROL	p. 53
[2]	MIDI THRU	p. 53
[3]	SUB KEYBOARD FUNCTION	p. 58
[4]	CONTROL MIDI CH. (Control MIDI Channel)	p. 54
[5]	UPPER ORGAN MIDI CH. (Upper Organ MIDI Channel)	p. 54
[6]	LOWER ORGAN MIDI CH. (Lower Organ MIDI Channel)	p. 54
[7]	PEDAL ORAGN MIDI CH. (Pedal Organ MIDI Channel)	p. 54
[8]	OTHER TONES MIDI CH. (Other Tones MIDI Channel)	p. 54

[PRESET] button's indicator lighted

Button	Parameter	Page
[1]	DRUM MIDI CH. (Drum MIDI Channel)	p. 54
[2]	SPRING SHOCK MIDI CH.	p. 54
[3]	MIDI SOUND CONTROLLERS SWITCH	p. 53
[4]	MIDI GENERAL CONTOROLLERS SWITCH	p. 53
[5]	MIDI PROGRAM CHANGE SWITCH	p. 53

3. Turn the [VIBRATO AND CHORUS] knob to adjust the setting.



If you press the VIBRATO AND CHORUS [ON] button, the setting will return to its initial value.

4. If you want to edit another parameter, press the appropriate button from [1] through [8] to select the parameter, and turn the [VIBRATO AND CHORUS] knob to adjust the setting.

When you want to stop editing, press the HARMONIC BAR PART [UPPER] button.

5. Press the [WRITE] button to finalize the settings of the MIDI-related parameters.

Parameter settings will be saved.

While the parameters are being saved, the [1]-[8] buttons will blink.

NOTE

Never turn off the power while parameters are being saved.

Connecting/disconnecting the sound generator and keyboard

- LOCAL CONTROL (ON/OFF)

Connects/disconnects the internal link between the VK-8's sound generator (organ voice and other tones) and its keyboard and other controllers.

Setting	Explanation
ON	The sound generator will be internally connected to the keyboard and other controllers. Normally you will use the VK-8 with this setting.
OFF	The sound generator will be internally disconnected from the keyboard and other controllers.

→ To prevent problems such as failure to sound, the Local Control setting will automatically be turned on each time the VK-8 is powered up.

NOTE

When the SUB KEYBOARD FUNCTION is on, the keyboard device connected to the MIDI KEYBOARD IN connector or MIDI PEDAL IN connector will be disconnected from the sound generator if Local Control is turned off.

Adding MIDI THRU functionality to the MIDI OUT connector

- MIDI THRU (ON/OFF)

This is a function by which the data received at the MIDI IN connector is re-transmitted from the MIDI OUT connector. Data received at the VK-8's MIDI KEYBOARD IN connector or MIDI PEDAL IN connector will be merged, and transmitted from the MIDI OUT connector. The MIDI Thru setting will automatically be turned off each time the VK-8 is powered up.

Setting	Explanation
ON	All data received at the MIDI IN connector will be re-transmitted from the MIDI OUT connector.
OFF	The MIDI Thru function will be turned off.

NOTE

The MIDI THRU function is valid only when SUB KEYBOARD FUNCTION is off.

NOTE

If the VK-8 receives a large amount of MIDI data or exclusive data, it may not be able to receive all of the MIDI data correctly. If this occurs, reduce the amount of MIDI data that is being transmitted from the external device, or break up the exclusive data into smaller units.

- MIDI SOUND CONTROLLERS SWITCH (ON/OFF)

This specifies whether Harmonic Bar data will be received using sound controller MIDI messages. Turn the [VIBRATO AND CHORUS] knob to the right to turn this on, or to the left to turn it off. At the factory settings, this is turned on.

Setting	Explanation
ON	Harmonic bar data can be received using sound controller MIDI messages.
OFF	Harmonic bar data will not be received using sound controller MIDI messages.

- MIDI GENERAL CONTOROLLERS SWITCH (ON/OFF)

This specifies whether Wheel Brake and Other Tone Glide data will be transmitted and received using MIDI general purpose controller messages. Turn the [VIBRATO AND CHORUS] knob to the right to turn this on, or to the left to turn it off. At the factory settings, this is turned on.

Setting	Explanation
ON	Wheel Brake and Other Tones Glide data will be transmitted and received using MIDI general purpose controller messages.
OFF	Wheel Brake and Other Tones Glide data will not be transmitted or received using MIDI general purpose controller messages.

- MIDI PROGRAM CHANGE SWITCH (ON/OFF)

This specifies whether preset selection data will be transmitted and received. Turn the [VIBRATO AND CHORUS] knob to the right to turn this on, or to the left to turn this off. At the factory settings, this is turned on.

Setting	Explanation
ON	Preset selection data will be transmitted and received.
OFF	Preset selection data will not be transmitted or received.

Advanced Use

○ When making MIDI channel settings

MIDI uses sixteen MIDI channels (1–16). If you want to play a connected external device, there will be no sound unless the MIDI channels of the transmitting and receiving devices match.



For information on the MIDI transmit/receive channels in effect when the power is turned on, refer to “MIDI Implementation” (p. 71).

1. Hold down the HARMONIC BAR PART [UPPER] and [PEDAL] buttons and press the [REVERB] button.

The indicators of buttons [1]–[8] will blink.

2. Use the [1]–[8] buttons to select the part whose MIDI channel you want to change.

There are 13 MIDI-related parameters. You can select all of these parameters by controlling the lighted/extinguished state of the [PRESET] buttons.

There are seven parameters that change the MIDI channel.



For the parameter that is assigned to each button, refer to page 52.

3. Press a key in the range of C2–D#3 to specify the MIDI channel.

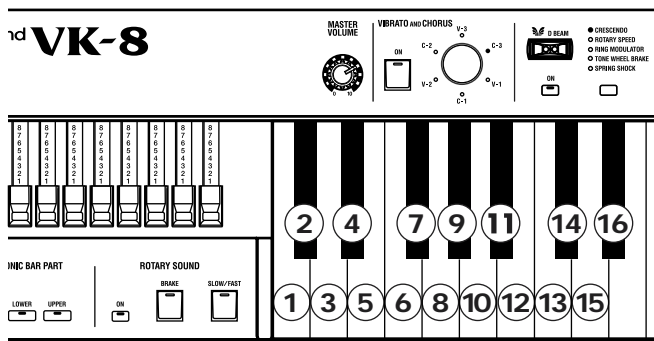

4. Press the [WRITE] button to finalize the settings of the MIDI channel.



Never turn off the power while parameters are being saved.

○ CONTROL MIDI CH. (Control MIDI Channel) (1–16) (Initial setting: 1 ch.)

Select the MIDI channel that will be used to transmit and receive MIDI messages to control the VK-8. This channel can be used to select presets on the VK-8, and to control the expression of the organ voice, etc.

○ UPPER ORGAN MIDI CH. (Upper Organ MIDI Channel) (1–16) (Initial setting: 1 ch.)

Sets the MIDI channel on which data will be transmitted and received for the upper organ voice.

○ LOWER ORGAN MIDI CH. (Lower Organ MIDI Channel) (1–16) (Initial setting: 3 ch.)

Sets the MIDI channel on which data will be transmitted and received for the lower organ voice.

○ PEDAL ORGAN MIDI CH. (Pedal Organ MIDI Channel) (1–16) (Initial setting: 2 ch.)

Sets the MIDI channel on which data will be transmitted and received for the pedal organ voice.

○ OTHER TONES MIDI CH. (Other Tones MIDI Channel) (1–16) (Initial setting: 4 ch.)

Specifies the MIDI channel on which data will be transmitted and received for Other Tones.

○ DRUM MIDI CH. (Drum MIDI Channel) (Initial setting: 10 ch.)

Specifies the MIDI channel on which drum notes will be received.

If you connect an external drum pad or sequencer and set its MIDI transmit channel to channel 10, you will be able to play drum sounds on the VK-8. In this case, the sounds of the GM2 standard drum set will be played (p. 70).

○ SPRING SHOCK MIDI CH. (Spring Shock MIDI Channel) (Initial setting: 9 ch.)

Specifies the MIDI channel on which Spring Reverb Shock data will be received and transmitted.



Different MIDI channels must be assigned to the upper/lower/pedal parts. It is not possible to select the same channel for two or more parts. MIDI channels which have already been assigned will not be available for selection.



Set the control MIDI channel to a different channel than used for Drum/Other Tone/Spring Shock. It is not possible to select the same MIDI channel. Nor is it possible to select a MIDI channel that's already selected.

Instructions for Playing External MIDI Sound Modules with the VK-8

The VK-8's keyboard was designed specifically for organ use, so it does not support the use of velocity. The instrument's keyboard behaves like those of traditional organs, with sounds being produced even at the slightest touch of the keys. This allows you to perform using glissando, rapid fingering, and other techniques characteristic of the organ. When recording your organ performances with the VK-8, we recommend using the organ MIDI channels.

Velocity is featured with the Other Tones; when recording performances using the Other Tones and when controlling external sound modules, we recommend that you make your sound selections from the Other Tones and use the MIDI channel for Other Tones.

With the factory settings, UPPER ORGAN MIDI CH. is set to Channel 1, LOWER ORGAN MIDI CH. to Channel 3, PEDAL ORGAN MIDI CH. to Channel 2, and OTHER TONES MIDI CH. to Channel 4.

NOTE

You cannot turn off the organ MIDI output.

MEMO

Set the Other Tones level to 0 when using an external sound module or when the Other Tones are not needed.

■ Equalizer and Other Settings

1. Hold down the HARMONIC BAR PART [UPPER] and [PEDAL] buttons and press the [AMPLIFIER] button.

The indicators of buttons [1]–[7] will blink.

2. Press one of the buttons from [1] through [7] to select the parameter that you want to edit.

There are seven parameters related to equalizer and other settings.

The following parameters are assigned to each button.

Button	Parameter	Page
[1]	EQ BASS	p. 55
[2]	EQ MIDDLE	p. 55
[3]	EQ TREBLE	p. 55
[4]	MASTER TUNE	p. 55
[5]	KEY TRANSPOSE	p. 56
[6]	CONTROL PEDAL POLARITY	p. 56
[7]	HOLD PEDAL POLARITY	p. 56

3. Turn the [VIBRATO AND CHORUS] knob to adjust the setting.

MEMO

If you press the VIBRATO AND CHORUS [ON] button, the setting will return to its initial value.

4. If you want to edit another parameter, press the appropriate button from [1] through [7] to select the parameter, and turn the [VIBRATO AND CHORUS] knob to adjust the setting.

When you want to stop editing, press the HARMONIC BAR PART [UPPER] button.

5. Press the [WRITE] button to finalize the settings of these parameters.

Parameter settings will be saved.

While the parameters are being saved, the [1]–[8] buttons will blink.

NOTE

Never turn off the power while parameters are being saved.

○ **EQ BASS (-5-0-+5)**

Adjusts the tone quality of the organ voice's lower range. Turning the [VIBRATO AND CHORUS] knob toward the right will emphasize the lower range of frequencies, while turning it toward the left will reduce the volume of the lower range.

○ **EQ MIDDLE (-5-0-+5)**

Adjusts the tone quality of the organ voice's midrange. Turning the [VIBRATO AND CHORUS] knob toward the right will emphasize the midrange frequencies, while turning it toward the left will reduce the volume of the midrange.

○ **EQ TREBLE (-5-0-+5)**

Adjusts the tone quality of the organ voice's upper range. Turning the [VIBRATO AND CHORUS] knob toward the right will emphasize the upper range of frequencies, while turning it toward the left will reduce the volume of the upper range.

Adjusting the pitch to match another instrument

○ **MASTER TUNE (-100cent-0-+100cent)**

This is a fine adjustment to the pitch of the VK-8. You can adjust the pitch of the entire instrument in 1 cent steps, relative to the pitch of A4 (middle A) = 440.0 Hz.

Advanced Use

Transposing the entire VK-8

○ KEY TRANSPOSE (-6-0-+5)

This transposes the entire VK-8. The value is in semitone steps over a range of -6-0-+5. With a setting of 0, there will be no transposition.

Switching the polarity of the control pedal

○ CONTROL PEDAL POLARITY (STANDARD / REVERSE)

Depending on the type of pedal switch, the result when the switch is operated may be the opposite of what you intend. If the pedal switch does not operate as described in this owner's manual, change the polarity setting.

Turning the [VIBRATO AND CHORUS] knob toward the right will select STANDARD, and all of the D BEAM TYPE indicators will light.

Turning it toward the left will select REVERSE, and all of the D BEAM TYPE indicators will go out.

Setting	Explanation
STANDARD	Use this setting if the pedal switch operates as described in this owner's manual.
REVERSE	Use this setting if the pedal switch pedal operates the opposite of the description in this owner's manual.

Switching the polarity of the Hold pedal

○ HOLD PEDAL POLARITY (STANDARD/ REVERSE)

Depending on the type of pedal switch, the result when the switch is pressed may be the opposite of what you intend. If the pedal switch does not operate as described in this owner's manual, change the polarity setting.

Turning the [VIBRATO AND CHORUS] knob toward the right will select STANDARD, and all of the D BEAM TYPE indicators will light.

Turning it toward the left will select REVERSE, and all of the D BEAM TYPE indicators will go out.

Setting	Explanation
STANDARD	Use this setting if the pedal switch operates as described in this owner's manual.
REVERSE	Use this setting if the pedal switch operates the opposite of the description in this owner's manual.

Parameters that are stored in a preset

■ Effect and Other Settings

1. Hold down the HARMONIC BAR PART [UPPER] and [PEDAL] buttons, and press the [PRESET] button.

The indicators of buttons [1]-[5] will blink.

2. Press one of the [1]-[5] buttons to select the parameter that you want to edit.

There are five effect-related parameters.

The following parameters are assigned to each button.

Button	Parameter	Page
[1]	REVERB TIME	p. 57
[2]	OTHER TONES CHORUS LEVEL	p. 57
[3]	OTHER TONES OCTAVE SHIFT	p. 57
[4]	HOLD PEDAL ASSIGN	p. 57
[5]	D BEAM ROTARY SPEED MODE	p. 57

3. Turn the [VIBRATO AND CHORUS] knob to adjust the setting.

MEMO

If you press the VIBRATO AND CHORUS [ON] button, the setting will return to its initial value.

4. If you want to edit another parameter, press the appropriate button from [1] through [5] to select the parameter, and turn the [VIBRATO AND CHORUS] knob to adjust the setting.

When you want to stop editing, press the HARMONIC BAR PART [UPPER] button.

5. Press the [WRITE] button to finalize the settings of the effect-related parameters.
6. Save the finalized parameter settings in a preset (p. 45).

NOTE

Never turn off the power while preset are being saved.

○ **REVERB TIME (0-127)**

Adjusts the length of the Reverb time. Higher values result in longer reverberation.

○ **OTHER TONES CHORUS LEVEL (0-127)**

Specify the chorus level when the chorus effect is applied to the Other Tones ELECTRIC PIANO1 or ELECTRIC PIANO2.

○ **OTHER TONES OCTAVE SHIFT (-3-0-+3)**

Transpose the Other Tones in steps of an octave.

○ **HOLD PEDAL ASSIGN (ORGAN & OTHER TONES/OTHER TONES)**

If a Hold pedal is connected, you can sustain the sound by pressing the pedal. This selects the part that will be sustained when you press the Hold pedal.

Turn the [VIBRATO AND CHORUS] knob toward the left to select ORGAN & OTHER TONES, or toward the right to select OTHER TONES.

○ **D BEAM ROTARY SPEED MODE (SLOW/FAST, CONTINUOUS)**

Specify the D Beam function when ROTARY SPEED is assigned to the D Beam.

Turn the [VIBRATO AND CHORUS] knob to the left to select SLOW/FAST, or to the right to select CONTINUOUS.

Setting	Explanation
SLOW/FAST	The rotary effect is toggled between slow and fast each time you move your hand over the D Beam controller.
CONTINUOUS	The rotary effect will change gradually from slow to fast or fast to slow as you move your hand closer to the D Beam controller.

Selecting the part that will play the Other Tones

○ **OTHER TONES PART ASSIGN**

Here you can select the part that will play OTHER TONES.

To play from the Lower part

- Split the VK-8 and play Other Tones from the Lower part (p. 44).
- Connect an external MIDI keyboard to the VK-8, and play the Lower part and Other Tones from the external MIDI keyboard (p. 59)

To play from the Pedal part

- Connect a pedal keyboard to the VK-8, and play the Pedal part and Other Tones from the pedal keyboard (p. 59)

1. Hold the HARMONIC BAR PART [UPPER] and [PEDAL] buttons, and press the [SPLIT] button.

The indicators of buttons [1]-[3] will blink.

2. Press one of the [1]-[3] buttons to select the part that will play OTHER TONES.

Button	Part
[1]	UPPER
[2]	LOWER
[3]	PEDAL

→ If you press the VIBRATO AND CHORUS [ON] button, the setting will return to its initial value.

When you want to stop editing, press the HARMONIC BAR PART [UPPER] button.

3. Press the [WRITE] button to confirm selection of the part that will play OTHER TONES.

4. Save the edited parameter setting in a preset (p. 45).

NOTE

Never turn off the power while preset are being saved.

NOTE

When you press the keyboard after the step1, the split point will be changed.

Connecting the VK-8 to External Devices

About MIDI

MIDI (Musical Instrument Digital Interface) is a worldwide standard for exchanging music data among electronic musical instruments and computers. MIDI does not send audio signals, but instead converts performance data and commands into digital data for transmission. The digital data handled by MIDI is collectively referred to as MIDI messages. Any device with a MIDI connector can be connected via a MIDI cable to another MIDI device, to allow data to be exchanged regardless of the manufacturer or model of the device.

MIDI IN connector: Receives MIDI messages from an external MIDI device.

MIDI OUT connector: Transmits MIDI messages from the VK-8.

About MIDI Channel

MIDI is able to transmit or receive a large number of messages over a single cable. In order to do so, it uses a concept called “channels” (analogous to the channels used in TV broadcasting), so that MIDI messages are received only when the channel of the receiving device matches the channel of the transmitting device.

Playing the VK-8 from an External MIDI Device

The VK-8 has four parts: the “upper part,” “lower part,” and “pedal part” of the organ voice, and “other tones.”

When you play a preset sound on the VK-8, you will hear the sound of the Upper Part. If you connect an external keyboard or pedal keyboard, you will be able to play the Lower Part or Pedal Part together with the Upper Part.

The VK-8 has three MIDI connectors.

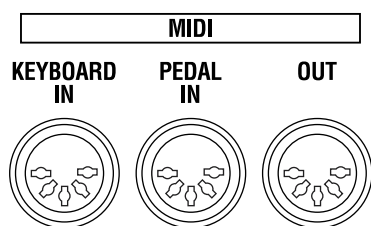

The function of these MIDI connectors will change depending on the “Sub-Keyboard Function” (p. 58) setting.

- When SUB KEYBOARD FUNCTION is on

KEYBOARD IN connector	Plays the sound of the Lower Part.
PEDAL IN connector	Plays the sound of the Pedal Part.

→ If the Sub Keyboard function is on, you can play the sound of the Lower part from a device connected to the KEYBOARD IN connector, and the sound of the Pedal part from a device connected to the PEDAL IN connector, without having to set the MIDI transmit channel of the external device to match the VK-8.

- When the SUB KEYBOARD FUNCTION is off

KEYBOARD IN Connector	Plays the Part specified for the MIDI channel being used for transmission.
PEDAL IN Connector	Plays the Part specified for the MIDI channel being used for transmission.

■ Changing the function of the MIDI IN connectors (SUB KEYBOARD FUNCTION)

1. Hold down the HARMONIC BAR PART [UPPER] [LOWER] [PEDAL] buttons, and press the [REVERB] button.

The indicators of buttons [1]-[8] will blink.

2. Press the [3] button.
3. Turn the [VIBRATO AND CHORUS] knob to change the setting.

Turn the knob clockwise to switch the Sub-Keyboard Function on, or turn the knob counterclockwise to switch it off.

- When SUB KEYBOARD FUNCTION is on

KEYBOARD IN connector	Plays the sound of the Lower Part.
PEDAL IN connector	Plays the sound of the Pedal Part.

→ If the Sub Keyboard function is on, you can play the sound of the Lower part from a device connected to the KEYBOARD IN connector, and the sound of the Pedal part from a device connected to the PEDAL IN connector, without having to set the MIDI transmit channel of the external device to match the VK-8.

- When the SUB KEYBOARD FUNCTION is off

KEYBOARD IN Connector	Plays the Part specified for the MIDI channel being used for transmission.
PEDAL IN Connector	Plays the Part specified for the MIDI channel being used for transmission.

If you decide not to change the setting, press the HARMONIC BAR PART [UPPER] button.

4. Press the [WRITE] button to finalize the Sub-Keyboard Function setting.

The sub keyboard function setting will be saved.

While the keyboard function setting are being saved, the [1]-[8] buttons will blink.

NOTE

Never turn off the power while parameters are being saved.

■ Using the VK-8 with a Dual Keyboard

You can connect an external keyboard and play the Lower Part of the VK-8 from the external keyboard.

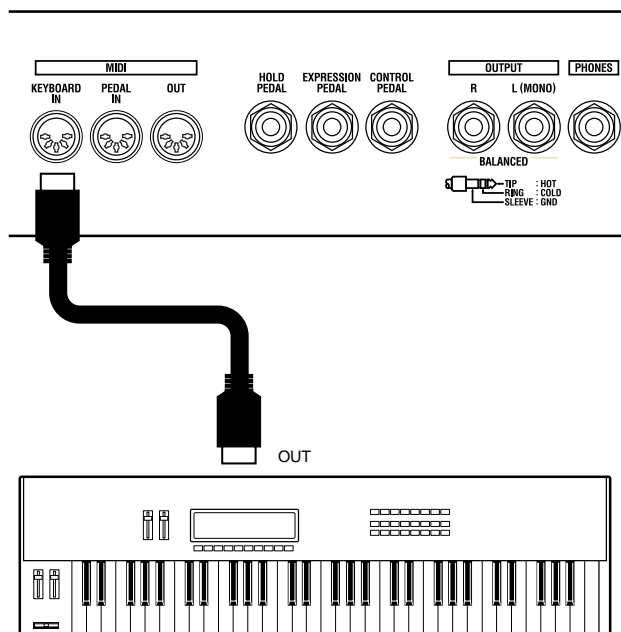

1. Turn off the power of the VK-8 and the external keyboard that you want to connect.
2. Use a commercially available MIDI cable to connect the MIDI OUT connector of your external keyboard to the MIDI KEYBOARD IN connector of the VK-8.
3. Turn on the power of your external keyboard.
4. Turn on the power of the VK-8.
5. Turn on the Sub-Keyboard Function (p. 58).

The Upper Part of the organ voice will sound when you play the VK-8, and the Lower Part will sound when you play the external keyboard.



At the factory settings, the Sub-Keyboard Function is turned on.

■ Connecting a Pedal Keyboard

You can connect a pedal keyboard and play the Pedal Part of the VK-8.

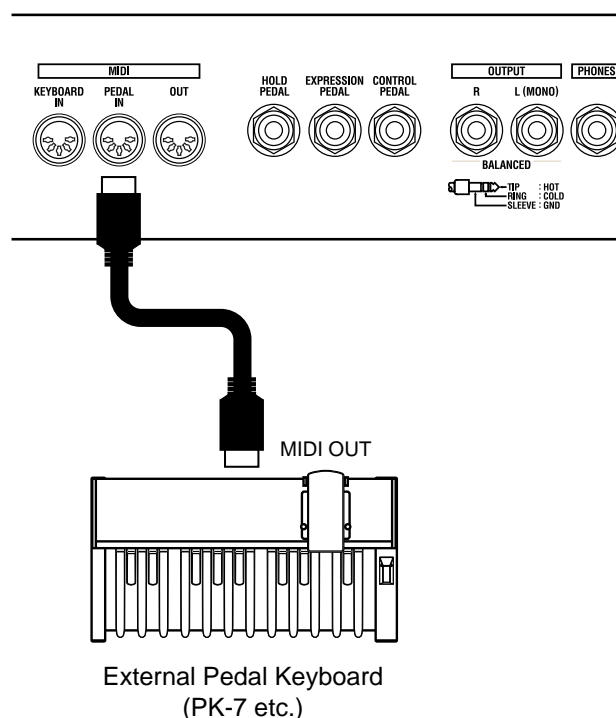

1. Turn off the power of the VK-8 and the pedal keyboard that you want to connect.
2. Use a commercially-available MIDI cable to connect the MIDI OUT connector of your pedal keyboard to the MIDI PEDAL IN connector of the VK-8.
3. Turn on the power of your pedal keyboard.
4. Turn on the power of the VK-8.
5. Turn on the Sub-Keyboard Function (p. 58).

The Upper Part of the organ voice will sound when you play the VK-8, and the Pedal Part will sound when you play the pedal keyboard.



At the factory settings, the Sub-Keyboard Function is turned on.

Using an External Sequencer to Record and Play Back

You can connect a sequencer to the VK-8 and record your playing. The sequencer will store your performance on the VK-8 as various types of MIDI data. MIDI data that is received can be sent from the sequencer back to the VK-8 to reproduce your performance.

→ *Some sequencers are able to record settings such as the VK-8's presets, OTHER TONES settings, and system settings.*

Making preparations for recording

1. Make sure that the power of the VK-8 and your sequencer is turned off.

NOTE

Turn off the power of the VK-8 and the other device before making connections. If you connect an external device when the power is turned on, damage or malfunctions may occur.

2. Use commercially-available MIDI cables to connect the VK-8 to your sequencer.

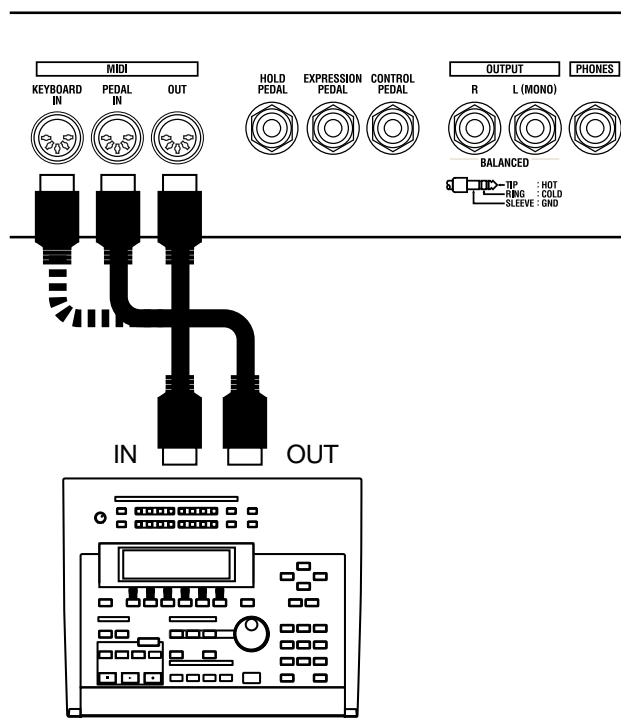

- Connect the VK-8's MIDI OUT connector to the sequencer's MIDI IN connector
- Connect the VK-8's MIDI KEYBOARD IN or MIDI PEDAL IN connector to the sequencer's MIDI OUT connector

3. Turn on the power of the external sequencer and the VK-8.

4. Turn off the Thru function of your sequencer.

This allows you to listen to the sound while you record.

Turn off Thru function so every note doesn't get sounded twice—once as the result of the performance data that directly conveys keyboard information to the organ voice or other tone, and a second time by the performance data returned via the Thru function of your sequencer.

NOTE

For details on setting the Thru function of your sequencer, refer to the owner's manual of your sequencer.

5. Turn off the SUB KEYBOARD FUNCTION (p. 58).

Carry out the recording

When you have finished making preparations for recording, start recording on your sequencer and record your performance.

6. Start recording on your sequencer.

7. Adjust the harmonic bars or select other tones if desired, and play the organ.

8. When you are finished playing, stop recording on your sequencer.

Play back your performance

9. Play back your sequencer, and your performance will be played back.

Saving VK-8 Settings on an External Sequencer (Bulk Dump)

You can connect the VK-8 to an external sequencer, then save VK-8 presets, and system settings on it. This function is called “bulk dump.”

Connect the VK-8 to your sequencer

1. Make sure that the power of the VK-8 and your sequencer is off.

NOTE

Turn off the power of the VK-8 and the other device before making connections. If you connect an external device when the power is turned on, damage or malfunctions may occur.

2. Use commercially-available MIDI cables to connect the VK-8 to your sequencer.

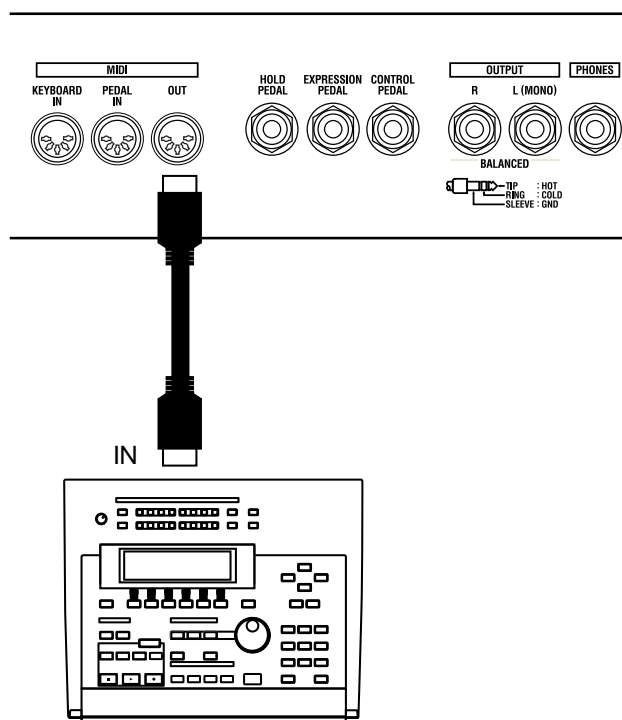

- Connect the VK-8's MIDI OUT connector to the sequencer's MIDI IN connector
3. Turn on the power of the external sequencer and the VK-8.
 4. Turn off the Thru function of your sequencer.

Save the settings

5. Hold down the HARMONIC BAR PART [UPPER][LOWER][PEDAL] buttons, and press the ROTARY SOUND [BRAKE] button.

The [VIBRATO AND CHORUS] button's indicator will blink.

6. Start recording on your sequencer.
7. Press the [VIBRATO AND CHORUS] button to begin saving the settings.

While the settings are being saved, the D BEAM type indicators will light in succession, starting from the bottom.

When the save has been completed, all indicators of the D Beam Type will blink.

8. Press the ROTARY SOUND [BRAKE] button.
9. Stop recording on your sequencer.

■ Loading Back Data That's Been Saved on an External Sequencer

1. Make sure that the power of the VK-8 and your sequencer is off.

NOTE

Turn off the power of the VK-8 and the other device before making connections. If you connect an external device when the power is turned on, damage or malfunctions may occur.

2. Use commercially-available MIDI cables to connect the VK-8 to your sequencer.

Connect the VK-8's MIDI IN connector to the sequencer's MIDI OUT connector

3. Turn on the power of your sequencer and VK-8.
4. Play back your sequencer.

When the playback has been completed, all indicators of the VIBRATO AND CHORUS Type and VIBRATO AND CHORUS [ON] button will blink.

5. When the external sequencer has finished playing back, press the VIBRATO AND CHORUS [ON] button.

The data from the external sequencer has thus been loaded into the VK-8.

Connecting a Rotary Speaker

In addition to providing a rotary speaker effect, the VK-8 also allows you to connect an actual rotary speaker. Connect your rotary speaker to the ROTARY TONE CABINET connector located on the rear panel.

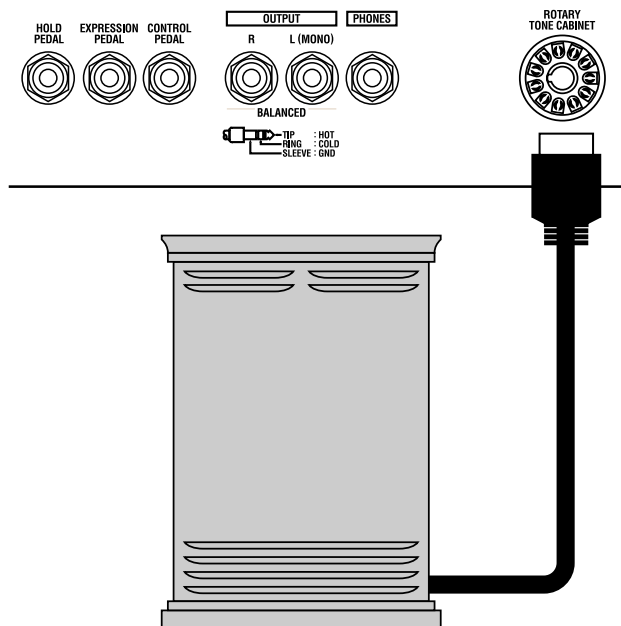

NOTE

Connecting a speaker which does not meet the following specifications may cause malfunctions.

The pinout for the ROTARY TONE CABINET connector is as follows:

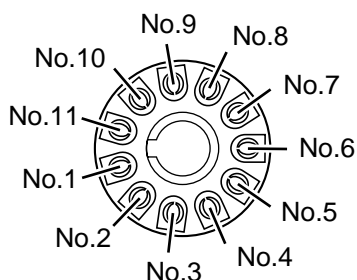

Pin No.	Output data
No. 1	ORGAN & OTHER TONES
No. 2	ORGAN & OTHER TONES
No. 3	NC
No. 4	GND
No. 5	GND
No. 6	POWER ON/OFF CONTROL
No. 7	FAST CONTROL
No. 8	SLOW CONTROL
No. 9	NC
No. 10	NC
No. 11	+24 V IN

- * Pin Nos. 1 and 2 are the output of the organ voice and OTHER TONES.
 - * Pin Nos. 6, 7, and 8 are the open collector output, and are at a nominal voltage of 5–30 V DC, and nominal loaded current of 50 mA maximum.
 - * Pin no. 11 detects the connection. If the nominal input voltage is outside the acceptable range (18–30 V DC), the connection will not operate correctly.
- The volume of the external speaker can be adjusted by the [MASTER VOLUME] knob.
 - ROTARY [SLOW/FAST] button will switch the rotational speed of the connected rotary speaker.
 - ROTARY [BRAKE] button will temporarily stop the rotation of the connected speaker. To resume rotation, press ROTARY [BRAKE] button again, or press ROTARY [SLOW/FAST] button.

NOTE

The rotary speaker effect of the organ voice will also be applied to the audio signal that is output from the ROTARY TONE CABINET connector. To prevent the rotary speaker effect from being applied to the audio signal that is output from the ROTARY TONE CABINET connector, press the ROTARY [ON] button to make it go dark (off).

MEMO

If you do not want Other Tones to be output from the ROTARY TONE CABINET connector, turn the [OTHER TONES LEVEL] knob all the way toward the left to set the Other Tones volume to zero. Alternatively, you can select a preset that does not include OTHER TONES.

Troubleshooting

If the VK-8 does not function in the way you expect, first check the following chart. If this does not resolve the problem, consult your dealer or a nearby Roland service station.

Problem	Check	Solution	Page
Power does not turn on	Power cord is not connected correctly.	Connect the power cord correctly.	p. 16
No sound/insufficient volume	Power of connected device is not turned on.	Turn on the power of the connected amp or mixer.	p. 17
	The volume of the connected amp or mixer is turned down.	Raise the volume of the connected amp or mixer.	p. 17
	Volume of the VK-8 is too low.	Turn the [Master Volume] knob toward "Max."	p. 19
	Volume of the connected amp or speaker has been turned down.	Raise the volume of the connected amp or mixer.	p. 17
	The expression pedal is not depressed.	While carefully monitoring the volume, depress the toe of the pedal.	p. 39
	If there is sound in the headphones, it is possible that a cable connecting the VK-8 to your amp/mixer is broken, or that your amp/mixer is malfunctioning.	Check your cables and amp/mixer system once again.	p. 17
	Local Control is turned off.	Turn the Local Control setting on.	p. 53
Organ voices cannot be heard	All harmonic bars are pushed all the way inward.	Pull out the harmonic bars.	p. 24
	The wheel brake is activated.	Release the wheel brake using the foot switch, D Beam.	p. 34 p. 40
OTHER TONES cannot be heard/ Volume is too low	Volume of the Other Tones is too low.	Turn the [OTHER TONES LEVEL] knob clockwise to increase the volume of the Other Tones.	p. 43
	The control pedal has been rocked toward the front.	If "OTHER TONES EXPRESSION" is assigned to the control pedal, the volume of the orchestra voice is controlled by means of the control pedal. While carefully monitoring the volume, depress the toe of the control pedal.	p. 40
	The expression pedal is not depressed.	While carefully monitoring the volume, depress the toe of the pedal.	p. 39
	The part that plays Other Tones has not been set correctly.	Set the OTHER TONE PART ASSIGN parameter to specify the part that will play Other Tones.	p. 57
	(If the expression pedal assignment is set to OTHER TONE CRESCENDO) The expression pedal has not been depressed.	Depress the toe of the expression pedal.	p. 39
Harmonic bars do not work	The part that reflects the harmonic bar settings is not selected correctly.	Press either the HARMONIC BAR PART [PEDAL] button, [LOWER] button, or [UPPER] button to select the part that will reflect the settings of the harmonic bars.	p. 23

Troubleshooting

Problem	Check	Solution	Page
Click is heard when you press/release a key	On a tone wheel organ, a slight “blip” noise is heard when you press or release a key. Initially, this was considered a defect, but as organs with this characteristic came to be used in a wide range of music, it grew to be considered part of the sound. The VK-8 faithfully simulates this key click noise, which is characteristic of tone wheel organs.	The volume of the click can be adjusted with “ON CLICK LEVEL” and “OFF CLICK LEVEL.”	p. 51
Pitch is incorrect	Tuning is incorrect.	Adjust the reference pitch.	p. 55
	Key Transpose (transposition) is in effect.	Either cancel Key Transpose, or change its setting.	p. 55
	Glide has been assigned to the control pedal. If Glide is assigned when no foot switch or control pedal is connected to the CONTROL PEDAL jack, the pitch may be incorrect.	Either connect a foot switch or control pedal to the CONTROL PEDAL jack, or assign a function other than Glide to the control pedal.	p. 40
	Wheel Brake is assigned to the control pedal. If Wheel Brake is assigned when no foot switch or control pedal is connected to the CONTROL PEDAL jack, the pitch may be incorrect.	Either connect a foot switch or control pedal to the CONTROL PEDAL jack, or assign a function other than Wheel Brake to the control pedal.	p. 41
Overdrive is not applied	Ring Modulator is applied to the organ voice.	Operate the control pedal or the D Beam to defeat the ring modulator.	p. 35
	Overdrive level is too low.	Turn the [OVERDRIVE] knob to adjust the depth of overdrive.	p. 33
	The expression pedal has been rocked toward the front.	While carefully monitoring the volume, depress the toe of the pedal.	p. 39
Overdrive will not be applied to the Other Tones.	Overdrive will not be applied to the Other Tones.	This is not malfunction.	- - -
	Reverb is not applied	Reverb level is too low.	Turn the REVERB [LEVEL] knob clockwise to adjust the reverb level.
Rotary effect is not applied	The ROTARY SOUND [ON] button is turned off (dark).	Press the ROTARY SOUND [ON] button to turn it on (lit).	p. 32
	The [BRAKE] button is on (lit).	Either turn the [BRAKE] button off (dark) or press the [SLOW/FAST] button, so that the brake will be released, and rotary will be applied.	p. 32
Can't set the MIDI channel	This is already specified as the MIDI channel of another part.	Either select a different channel for the other part that is using that channel and then make the desired setting, or select a MIDI channel that no other part is using.	p. 54
	You are attempting to set the MIDI channel of the Other Tones, Drum, or spring shock to the MIDI channel that has been specified as the Control MIDI Channel.	It is not possible to set the MIDI channel of the Other Tones, Drum, or spring shock to the same channel as the Control MIDI Channel.	p. 54

Problem	Check	Solution	Page
MIDI messages are not transmitted/receive correctly	The MIDI channel of each part is not set correctly.	Set the MIDI channels correctly.	p. 54
	The Control MIDI Channel is not set correctly.	Make sure that the VK-8's program changes and expression data are being transmitted on the correct MIDI channel.	p. 54
	The sequencer playback tempo is not set correctly.	Have the sequencer play back the data at the same tempo that was used when the exclusive data was recorded.	p. 60
	The Sub Keyboard Function is not set correctly.	Check the Sub Keyboard Function setting.	p. 58
Can't hear spring shock noise	Reverb level is set to 0.	Turn the REVERB [LEVEL] knob clockwise to adjust the reverb level.	p. 37
Can't hear the 1' harmonic bar	PERCUSSION is turned on. If PERCUSSION is on, the sound of the 1' harmonic bar will not be heard.	This is not malfunction.	- - -
Rotary changes to FAST unintentionally	Control pedal or D Beam is assigned to "CRESCENDO." If the control pedal or D Beam is assigned to "CRESCENDO" when the [SLOW/FAST] button is in the SLOW state, and you fully depress the control pedal, or place your hand very close to the D Beam, the rotary will switch to FAST.	If the [SLOW/FAST] button is in the SLOW state, rocking back onto the heel of the control pedal, or moving your hand away from the D Beam will cause the rotary to return to SLOW.	p. 34 p. 40
Hold pedal or control pedal operation is reversed	The control pedal's polarity is reversed.	Depending on the type of pedal switch or expression pedal, it may have the opposite operation when depressed. Switch the polarity of the control pedal.	p. 56
D Beam sensitivity is incorrect	Something was covering the D Beam when the power was turned on. When the power is turned on, the VK-8 automatically adjusts the sensitivity of the D Beam. For this reason, do not place any objects on the D Beam or cover it with your hand when the power is turned on.	Readjust the sensitivity of the D Beam.	p. 36
	D Beam sensitivity is incorrect.	Readjust the sensitivity of the D Beam.	p. 36
	The instrument is placed in a location where there is a large amount of infrared light.	The D Beam will not function correctly in a location where there is a large amount of infrared light.	p. 36
Preset memory contents are lost	The power was turned off while data was being written into preset memory.	Never turn off the power while data is being written into preset memory.	- - -
Can't select Other Tones	The VK-8 is in Preset mode	Get the [PRESET] button to go out, thus turning off Preset mode.	p. 22
	The VK-8 is in Edit mode.	Exit Edit mode.	p. 47
	The VK-8 is in Demo mode.	Exit Demo mode.	p. 21

■ Error Indications

When an incorrect operation is performed, or when an operation cannot be carried out correctly, the VK-8 will light all of its indicators for a few seconds. Errors are divided into two categories—those that show up at power-up, and those that occur during normal operation. Please read the following explanations carefully, and take the appropriate action.

When you turn on the power

All indicators light for several seconds

Cause: The content of backup memory has been returned to the condition it was in originally, when the unit left the factory. In most cases, this occurs when the power was turned off while data was being written into memory.

During normal operation

All indicators light for several seconds

Cause 1: A MIDI cable was disconnected or broken.

Action: Make sure that the MIDI cable is connected correctly.

Cause 2: A large amount of MIDI data was received all at once.

Action: Reduce the amount of MIDI data that is being transmitted to the VK-8.

Cause 3: System exclusive data was not received correctly.

Action: Check the settings of the transmitting device, or the data that is being transmitted.

Preset/OTHER TONES List

■ Preset List

PRESET Number	UPPER PART	LOWER PART	PEDAL PART	PERCUSSION	VIBRATO AND CHORUS	ROTARY
1-1	88 8000 000	83 8000 000	82	3rd, SOFT, FAST	OFF	SLOW
1-2	80 0000 888	83 8000 000	82	OFF	C-3	FAST
1-3	88 8800 000	83 8000 000	82	3rd, SOFT, FAST	C-3	SLOW
1-4	88 8800 000	00 8800 000	84	3rd, NORM, FAST	OFF	SLOW
1-5	88 8008 008	83 8000 000	82	3rd, SOFT, SLOW	OFF	SLOW
1-6	85 8500 005	03 8300 000	73	OFF	C-3	SLOW
1-7	88 8000 678	87 8600 000	84	OFF	C-3	SLOW
1-8	60 8807 006	00 8800 000	84	OFF	OFF	SLOW
2-1	88 8000 000	00 8888 000	73	2nd, SOFT, SLOW	OFF	SLOW
2-2	88 8008 008	83 8000 000	82	3rd, SOFT, SLOW	OFF	FAST
2-3	88 8800 000	00 8800 000	84	2nd, SOFT, FAST	OFF	SLOW
2-4	88 8800 000	00 8800 000	84	3rd, NORM, FAST	OFF	SLOW
2-5	80 0888 888	83 8000 000	82	3rd, NORM, FAST	C-3	FAST
2-6	88 8000 000	00 8600 000	82	3rd, NORM, FAST	OFF	SLOW
2-7	88 8080 880	00 8600 000	82	OFF	OFF	OFF
2-8	28 0030 350	44 8600 000	82	3rd, SOFT, FAST	C-3	FAST
3-1	88 8000 000	83 8000 000	82	3rd, SOFT, FAST	C-3	SLOW
3-2	88 8800 000	83 8000 000	82	3rd, SOFT, FAST	C-1	SLOW
3-3	80 0000 888	83 8000 000	82	OFF	C-3	FAST
3-4	88 8000 000	83 8000 000	82	3rd, SOFT, FAST	OFF	SLOW
3-5	80 0000 888	83 8000 000	82	OFF	C-3	FAST
3-6	88 8000 000	83 8000 000	82	3rd, SOFT, FAST	C-1	SLOW
3-7	81 8151 608	00 0503 000	82	OFF	C-2	SLOW
3-8	84 8500 008	00 0806 000	82	OFF	OFF	SLOW
4-1	80 7050 404	00 8500 000	54	OFF	V-3	SLOW
4-2	80 3700 000	00 8500 000	54	OFF	V-3	BRAKE
4-3	00 3800 460	00 8800 000	84	OFF	OFF	BRAKE
4-4	00 4544 222	00 8800 000	84	OFF	OFF	BRAKE
4-5	00 6876 540	00 8800 000	84	OFF	OFF	OFF
4-6	00 7373 430	00 8800 000	84	OFF	OFF	OFF
4-7	00 8030 000	00 8800 000	84	OFF	OFF	OFF
4-8	60 8807 006	00 8800 000	84	OFF	OFF	OFF
5-1	88 8000 000	83 8000 000	82	3rd, SOFT, FAST	OFF	SLOW
5-2	80 0000 888	83 8000 000	82	OFF	C-3	FAST
5-3	88 8800 000	83 8000 000	82	3rd, SOFT, FAST	C-3	SLOW
5-4	88 8800 000	00 8800 000	84	3rd, NORM, FAST	OFF	SLOW
5-5	88 8008 008	83 8000 000	82	3rd, SOFT, SLOW	OFF	SLOW
5-6	85 8500 005	03 8300 000	73	OFF	C-3	SLOW
5-7	88 8000 678	87 8600 000	84	OFF	C-3	SLOW
5-8	60 8807 006	00 8800 000	84	OFF	OFF	SLOW

Preset/OTHER TONES List

PRESET Number	UPPER PART	LOWER PART	PEDAL PART	PERCUSSION	VIBRATO AND CHORUS	ROTARY
6-1	88 8000 000	00 8888 000	73	2nd, SOFT, SLOW	OFF	SLOW
6-2	88 8008 008	83 8000 000	82	3rd, SOFT, SLOW	OFF	FAST
6-3	88 8800 000	00 8800 000	84	2nd, SOFT, FAST	OFF	SLOW
6-4	88 8800 000	00 8800 000	84	3rd, NORM, FAST	OFF	SLOW
6-5	80 0888 888	83 8000 000	82	3rd, NORM, FAST	C-3	FAST
6-6	88 8000 000	00 8600 000	82	3rd, NORM, FAST	OFF	SLOW
6-7	88 8080 880	00 8600 000	82	OFF	OFF	OFF
6-8	28 0030 350	44 8600 000	82	3rd, SOFT, FAST	C-3	FAST
7-1	88 8000 000	83 8000 000	82	3rd, SOFT, FAST	C-3	SLOW
7-2	88 8800 000	83 8000 000	82	3rd, SOFT, FAST	C-1	SLOW
7-3	80 0000 888	83 8000 000	82	OFF	C-3	FAST
7-4	88 8000 000	83 8000 000	82	3rd, SOFT, FAST	OFF	SLOW
7-5	80 0000 888	83 8000 000	82	OFF	C-3	FAST
7-6	88 8000 000	83 8000 000	82	3rd, SOFT, FAST	C-1	SLOW
7-7	81 8151 608	00 0503 000	82	OFF	C-2	SLOW
7-8	84 8500 008	00 0806 000	82	OFF	OFF	SLOW
8-1	80 7050 404	00 8500 000	54	OFF	V-3	SLOW
8-2	80 3700 000	00 8500 000	54	OFF	V-3	BRAKE
8-3	00 3800 460	00 8800 000	84	OFF	OFF	BRAKE
8-4	00 4544 222	00 8800 000	84	OFF	OFF	BRAKE
8-5	00 6876 540	00 8800 000	84	OFF	OFF	OFF
8-6	00 7373 430	00 8800 000	84	OFF	OFF	OFF
8-7	00 8030 000	00 8800 000	84	OFF	OFF	OFF
8-8	60 8807 006	00 8800 000	84	OFF	OFF	OFF

*Preset 5-1-8-8 have the same contents as 1-1-4-8.

■ OTHER TONES List

Button's Number	Tone
[1]	PIANO
[2]	ELECTRIC PIANO 1
[3]	ELECTRIC PIANO 2
[4]	STRINGS
[5]	JAZZ SCAT
[6]	CHOIR
[7]	SYNTH
[8]	BRASS

Edit Parameters

Settings that are saved for the entire System

- Rotary-related settings
 - ROTARY WOOFER LEVEL
 - ROTARY TWEETER LEVEL
 - ROTARY WOOFER RISE TIME
 - ROTARY TWEETER RISE TIME
 - ROTARY WOOFER FALL TIME
 - ROTARY TWEETER FALL TIME
 - ROTARY WOOFER SPREAD
 - ROTARY TWEETER SPREAD
 - ROTARY WOOFER SPEED SLOW
 - ROTARY TWEETER SPEED SLOW
 - ROTARY WOOFER SPEED FAST
 - ROTARY TWEETER SPEED FAST
 - ROTARY MIC DISTANCE
 - ROTARY RANDOMIZE
- Click Noise and Percussion settings
 - ON CLICK LEVEL
 - OFF CLICK LEVEL
 - PERCUSSION SOFT LEVEL
 - PERCUSSION NORMAL LEVEL
 - PERCUSSION SLOW TIME
 - PERCUSSION FAST TIME
 - PERCUSSION RECHARGE TIME
 - PERCUSSION H-BAR LEVEL
- MIDI-related settings
 - LOCAL CONTROL
 - MIDI THRU
 - SUB KEYBOARD FUNCTION
 - CONTROL MIDI CH.
 - UPPER ORGAN MIDI CH.
 - LOWER ORGAN MIDI CH.
 - PEDAL ORAGN MIDI CH.
 - OTHER TONES MIDI CH.
 - DRUM MIDI CH.
 - SPRING SHOCK MIDI CH.
 - MIDI SOUND CONTROLLERS SWITCH
 - MIDI GENERL CONTROLLERS SWITCH
 - MIDI PROGRAM CHANGE SWITCH
- Equalizer and other settings
 - EQ BASS
 - EQ MIDDLE
 - EQ TREBLE
 - MASTER TUNE
 - KEY TRANSPOSE
 - FOOT CONTROL POLARITY
 - HOLD PEDAL POLARITY
 - D BEAM SENSITIVITY
- CONTROL PEDAL ASSIGN

Parameters that are stored in a preset

- Effect and other setting
 - REVERB TIME
 - OTHER TONES CHORUS LEVEL
 - OTHER TONES OCTAVE SHIFT
 - HOLD PEDAL ASSIGN
 - D BEAM ROTARY SPEED MODE
- OTHER TONES PART ASSIGN
- SPLIT POINT
- EXPRESSION PEDAL MODE
- Panel settings.
 - The sounds of the Upper part, Lower part, and Pedal part of the Harmonic Bar settings.
 - ROTARY [ON] button
 - ROTARY [BRAKE] button
 - ROTARY [SLOW/FAST] button
 - [TONE WHEEL] button
 - [LEAKAGE] knob
 - [AMPLIFIER] button
 - [OVERDRIVE] knob
 - [TONE] knob
 - [REVERB] button
 - REVERB [LEVEL] knob
 - PERCUSSION [SECOND] button
 - PERCUSSION [THIRD] button
 - PERCUSSION [SOFT] button
 - PERCUSSION [SLOW] button
 - VIBRATO AND CHORUS [ON] button
 - [VIBRATO AND CHORUS] knob
 - D BEAM [ON] button
 - [D BEAM] button
 - [SPLIT] button
 - OTHER TONES [1]–[8] button
 - [OTHER TONES LEVEL] knob

Drum List

	27	High Q
28		Slap
		Scratch Push [EXC7]
29	30	Scratch Pull [EXC7]
31		Sticks
	32	Square Click
33		Metronome Click
	34	Metronome Bell
35		Acoustic Bass Drum
C2	36	Bass Drum 1
	37	Side Stick
38		Acoustic Snare
	39	Hand Clap
40		Electric Snare
		Low Floor Tom
41	42	Closed Hi-hat [EXC1]
43		High Floor Tom
	44	Pedal Hi-hat [EXC1]
45		Low Tom
	46	Open Hi-hat [EXC1]
47		Low-Mid Tom
C3	48	High Mid Tom
	49	Crash Cymbal 1
50		High Tom
	51	Ride Cymbal 1
52		Chinese Cymbal
		Ride Bell
53	54	Tambourine
55		Splash Cymbal
	56	Cowbell
57		Crash Cymbal 2
	58	Vibra-slap
59		Ride Cymbal 2
C4	60	High Bongo
	61	Low Bongo
62		Mute Hi Conga
	63	Open Hi Conga
64		Low Conga
		High Timbale
65	66	Low Timbale
67		High Agogo
	68	Low Agogo
69		Cabasa
	70	Maracas
71		Short Whistle [EXC2]
C5	72	Long Whistle [EXC2]
	73	Short Guiro [EXC3]
74		Long Guiro [EXC3]
	75	Claves
76		Hi Wood Block
		Low Wood Block
77	78	Mute Cuica [EXC4]
79		Open Cuica [EXC4]
	80	Mute Triangle [EXC5]
81		Open Triangle [EXC5]
	82	Shaker
83		Jingle Bell
C6	84	Bell Tree
	85	Castanets
86		Mute Surdo [EXC6]
	87	Open Surdo [EXC6]
88		--- --- ---

When the SUB KEYBOARD FUNCTION (p. 58) is off, and the MIDI channel of an external device connected to VK-8 is set to the same channel as the DRUM MIDI CH. (p. 54) of the VK-8, you can sound a drum set using the external MIDI device.

MIDI Implementation

Model: VK-8 (Combo Organ)

Date: Dec. 1, 2001

Version: 1.00

1. Receive data

- * The VK-8 has two MIDI IN connectors: KEYBOARD IN and PEDAL IN. If the SUB KEYBOARD FUNCTION (p. 58) is ON, messages input to KEYBOARD IN will be received as messages for the Lower part, regardless of their channel number. Messages input to PEDAL IN will be received as messages for the Pedal part, regardless of their channel number (Omni On).
- * When the SUB KEYBOARD FUNCTION (p. 58) is OFF, MIDI messages will control each part according to their MIDI channel number (Omni Off). At the factory settings, each part is set to the following transmit/receive channels.

CONTROL	1ch
UPPER ORGAN	1ch
LOWER ORGAN	3ch
PEDAL ORGAN	2ch
OTHER TONES	4ch
DRUMS	10ch
SPRING SHOCK	9ch

■Channel Voice Messages

●Note off

Status	2nd byte	3rd byte
8nH	kkH	vvH
9nH	kkH	00H

n = MIDI channel number : 0H - FH (ch.1 - ch.16)
 kk = note number : 00H - 7FH (0 - 127)
 vv = note off velocity : 00H - 7FH (0 - 127)

- * When the SUB KEYBOARD FUNCTION (p. 58) is ON, the input to the KEYBOARD IN will be handled as messages for the LOWER PART, and the input to PEDAL IN will be handled as messages for the PEDAL PART.

●Note on

Status	2nd byte	3rd byte
9nH	kkH	vvH

n = MIDI channel number: 0H - FH (ch.1 - ch.16)
 kk = note number : 00H - 7FH (0 - 127)
 vv = note on velocity : 00H - 7FH (0 - 127)

- * When the SUB KEYBOARD FUNCTION (p. 58) is ON, the input to the KEYBOARD IN will be handled as messages for the LOWER PART, and the input to PEDAL IN will be handled as messages for the PEDAL PART.

●Control Change

○Modulation (Controller number 1)

Status	2nd byte	3rd byte
BnH	01H	vvH

n = MIDI channel number : 0H - FH (ch.1 - ch.16)
 vv = modulation depth : 00H - 7FH (0 - 127)

- * Received only for the Other Tones Part.

○Data Entry (Controller Number 6, 38)

Status	2nd byte	3rd byte
BnH	06H	mmH
BnH	26H	llH

n = MIDI channel number : 0H - FH (ch.1 - ch.16)
 mm, ll = the value of the parameter specified by RPN/NRPN
 mm = upper byte (MSB), ll = lower byte (LSB)

○Volume (Controller number 7)

Status	2nd byte	3rd byte
BnH	07H	vvH

n = MIDI channel number : 0H - FH (ch.1 - ch.16)
 vv = volume : 00H - 7FH (0 - 127)

- * Received only for the Other Tones Part.

○Panpot (Controller number 10)

Status	2nd byte	3rd byte
BnH	0AH	vvH

n = MIDI channel number: 0H-FH (ch.1-ch.16)
 vv = panpot: 00H-40H-7FH (Left-Center-Right)
 * Received only for the Other Tones Part.

○Expression (Controller number 11)

Status	2nd byte	3rd byte
BnH	0BH	vvH

n = MIDI channel number : 0H - FH (ch.1 - ch.16)
 vv = expression : 00H - 7FH (0 - 127)

- * If you want to control all of the Organ Parts, transmit data on the channel specified by the CONTROL MIDI CH. setting (factory setting: channel 1). It is not possible to separately control each part of the Organ Part.
- * When the SUB KEYBOARD FUNCTION (p. 58) is ON, this has the same function as an expression pedal connected to the VK-8's EXPRESSION PEDAL jack.

○General Purpose Controller 1 (Controller number 16) (Other tones glide)

Status	2nd byte	3rd byte
BnH	10H	vvH

n = MIDI channel number: 0H - FH (ch.1 - ch.16)
 vv = control value : 00H - 7FH (0 - 127) 0-63 = OFF, 64-127 = ON

- * Received only for the Other Tones Part.
- * Not received when MIDI GENERAL CONTROLLERS SWITCH (p. 53) is OFF.

○General Purpose Controller 2 (Controller number 17) (Wheel Brake)

Status	2nd byte	3rd byte
BnH	11H	vvH

n = MIDI channel number: 0H - FH (ch.1 - ch.16)
 vv = control value : 00H - 7FH (0 - 127) 0-63 = OFF, 64-127 = ON

- * When SUB KEYBOARD FUNCTION (p. 58) is OFF, this is received on the channel specified for CONTROL MIDI CH. (p. 54) (factory setting: channel 1).
- * Not received by the Other Tones part.
- * Not received when MIDI GENERAL CONTROLLERS SWITCH (p. 53) is OFF.

○Hold 1 (Controller number 64)

Status	2nd byte	3rd byte
BnH	40H	vvH

n = MIDI channel number : 0H - FH (ch.1 - ch.16)
 vv = control value : 00H - 7FH (0 - 127) 0-63 = OFF, 64-127 = ON

- * When the SUB KEYBOARD FUNCTION (p. 58) is ON, this has same function as a hold pedal connected to the VK-8's HOLD PEDAL jack.

○Sound Controller 1-9 (Controller number 70-78) (Harmonic Bars)

Status	2nd byte	3rd byte
BnH	ccH	vvH

n = MIDI channel number : 0H - FH (ch.1 - ch.16)
 cc = control change number : 46H - 4EH (70-78)
 vv = control value : 00H - 7FH (0 - 127)

- * Receives harmonic bar values.
- * Not received by the Other Tones part.
- * When the SUB KEYBOARD FUNCTION (p. 58) is ON, the input to the KEYBOARD IN will be handled as messages for the LOWER PART, and the input to PEDAL IN will be handled as messages for the PEDAL PART.
- * Not received when MIDI SOUND CONTROLLERS SWITCH (p. 53) is OFF.

cc	H.Bar Feet
46H	16'
47H	5 1/3'
48H	8'
49H	4'
4AH	2 1/3'
4BH	2'
4CH	1 3/5'
4DH	1 1/3'
4EH	1'

- * Control values and harmonic bars are related as follows.

vv	H.Bar Level
00H - 0EH	0
0FH - 1CH	1
1DH - 2AH	2
2BH - 38H	3
39H - 47H	4
48H - 55H	5
56H - 63H	6
64H - 71H	7
72H - 7FH	8

○General Purpose Controller 5 (Controller number 80) (Rotary Speed)

Status	2nd byte	3rd byte
BnH	50H	vvH

n = MIDI channel number: 0H - FH (ch.1 - ch.16)
 vv = control value: 00H - 7FH (0 - 127)

- * When SUB KEYBOARD FUNCTION is OFF (p. 58), this is received on the channel specified for CONTROL MIDI CH. (p. 54) (factory setting: channel 1).
- * Not received when MIDI GENERAL CONTROLLERS SWITCH (p. 53) is OFF.

MIDI Implementation

○General Purpose Controller 6 (Controller number 81) (Rotary Brake)

<u>Status</u>	<u>2nd byte</u>	<u>3rd byte</u>
BnH	51H	vvH
n = MIDI channel number:	0H - FH (ch.1 - ch.16)	
vv = control value:	00H - 7FH (0 - 127) 0-63 = SPIN, 64-127 = BRAKE	
* When SUB KEYBOARD FUNCTION is OFF (p. 58), this is received on the channel specified for CONTROL MIDI CH. (p. 54) (factory setting: channel 1).		
* Not received when MIDI GENERAL CONTROLLERS SWITCH (p. 53) is OFF.		

○RPN MSB/LSB (Controller number 100, 101)

<u>Status</u>	<u>2nd byte</u>	<u>3rd byte</u>
BnH	65H	mmH
BnH	64H	llH
n = MIDI channel number:	0H - FH (ch.1 - 16)	
mm = upper byte (MSB) of parameter number specified by RPN		
ll = lower byte (LSB) of parameter number specified by RPN		

<<< RPN >>>

Control Changes include RPN (Registered Parameter Numbers), which are extended. When using RPNs, first RPN (Controller numbers 100 and 101; they can be sent in any order) should be sent in order to select the parameter, then Data Entry (Controller numbers 6 and 38) should be sent to set the value. Once RPN messages are received, Data Entry messages that is received at the same MIDI channel after that are recognized as changing toward the value of the RPN messages. In order not to make any mistakes, transmitting RPN Null is recommended after setting parameters you need.

This device receives the following RPNs.

RPN	Data entry	
<u>MSB_LSB</u>	<u>MSB_LSB</u>	<u>Notes</u>
00H, 00H	mmH, llH	Pitch Bend Sensitivity mm: 00H - 18H (0 - 24 semitones) ll: ignored (processed as 00H) Up to 2 octave can be specified in semitone steps. * Not received by the Organ part.
00H, 01H	mmH, llH	Master Fine Tuning mm, ll: 20 00H - 40 00H (-8192 x 50 / 8192 - 0 - +8192 x 50 / 8192 cent) * Not received by the Organ part.
00H, 02H	mmH, llH	Master Coarse Tuning mm: 10H - 40H - 70H (-48 - 0 - +48 semitones) ll: ignored (processed as 00H) * Not received by the Organ part.
7FH, 7FH	---, ---	RPN null RPN and NRPN will be set as "unspecified." Once this setting has been made, subsequent Parameter values that were previously set will not change. mm, ll: ignored

●Program Change

<u>Status</u>	<u>2nd byte</u>	
CnH	ppH	
n = MIDI channel number :	0H - FH (ch.1 - ch.16)	
pp = program number :	00H - 3FH (prog.1 - prog.64) (Preset) 00H - 07H (prog.1 - prog.8) (Other Tones)	
* Not received when MIDI PROGRAM CHANGE SWITCH is OFF (p. 53) (factory setting: ON).		
* Presets are received on the channel specified by CONTROL MIDI CH. (p. 54) (factory setting: channel 1). The Other Tones part is received on the channel specified by OTHER TONES MIDI CH. (p. 54) (factory setting: channel 4).		
* Preset numbers will be switched when SUB KEYBOARD FUNCTION (p. 58) is ON.		

●Pitch Bend Change

<u>Status</u>	<u>2nd byte</u>	<u>3rd byte</u>
EnH	llH	mmH
n = MIDI channel number :	0H - FH (ch.1 - ch.16)	
mm, ll = Pitch Bend value :	00 00H - 40 00H - 7F 7FH (-8192 - 0 - +8191)	
* Received only for the Other Tones Part.		

■Channel Mode messages

●All Sound Off (Controller number 120)

<u>Status</u>	<u>2nd byte</u>	<u>3rd byte</u>
BnH	78H	00H
n = MIDI channel number :	0H - FH (ch.1 - ch.16)	
* When this message is received, all notes currently sounding on the corresponding channel will be turned off.		

●Reset All Controllers (Controller number 121)

<u>Status</u>	<u>2nd byte</u>	<u>3rd byte</u>
BnH	79H	00H
n = MIDI channel number :	0H - FH (ch.1 - ch.16)	
* When this message is received, the following controllers will be set to their reset values.		
<u>Controller</u>	<u>Reset value</u>	
Pitch Bend Change	±0 (center)	
Modulation	0 (off)	
Hold 1	0 (off)	

●All Note Off (Controller number 123)

<u>Status</u>	<u>2nd byte</u>	<u>3rd byte</u>
BnH	7BH	00H
n = MIDI channel number :	0H - FH (ch.1 - ch.16)	
* When All Note Off is received, all currently sounding notes of the corresponding channel will be turned off. However if Hold 1 is on, the sound will be held until these are turned off.		

■System Realtime Messages

●Active Sensing

<u>Status</u>	
FEH	
* When an Active Sensing message is received, the unit will begin monitoring the interval at which MIDI messages are received. During monitoring, if more than 420 ms passes without a message being received, the same processing will be done as when All Sound Off, All Note Off, and Reset All Controllers messages are received. Then monitoring will be halted.	

■System Exclusive Messages

<u>Status</u>	<u>data byte</u>	<u>Status</u>
F0H	iiH, ddH,, eeH	F7H
F0H :	System Exclusive message status	
ii = ID number :	This is the ID number (manufacturer ID) that specifies the manufacturer whose exclusive message this is. Roland's manufacturer ID is 41H. ID numbers 7EH and 7FH are defined in an expansion of the MIDI standard as Universal Non-realtime messages (7EH) and Universal Realtime Messages (7FH).	
dd,, ee = data :	00H - 7FH (0 - 127)	
F7H :	EOX (End Of Exclusive) This is the last status of system exclusive message.	

The System Exclusive Messages received by VK-8 are; messages related to mode settings, Universal Realtime System Exclusive messages, Data Requests (RQ1), and Data Set (DT1).

●Universal Non-realtime System Exclusive Messages

○Identity Request Message

<u>Status</u>	<u>Data byte</u>	<u>Status</u>
F0H	7EH, dev, 06H, 01H	F7H
<u>Byte</u>	<u>Explanation</u>	
FOH	Exclusive status	
7FH	ID number (universal realtime message)	
dev	Device ID (dev: 10H (17) fixed)	
06H	Sub ID#1 (General Information)	
01H	Sub ID#2 (Identity Request)	
F7H	EOX (End Of Exclusive)	
* The "dev" is own device number or 7FH (Broadcast)		

●Data Request 1 RQ1

This message requests the other device to transmit data. The address and size indicate the type and amount of data that is requested. When a Data Request message is received, if the device is in a state in which it is able to transmit data, and if the address and size are appropriate, the requested data is transmitted as a Data Set 1 (DT1) message. If the conditions are not met, nothing is transmitted. The model ID of the exclusive messages used by this instrument is 00 4DH.

<u>Status</u>	<u>data byte</u>
F0H	41H, dev, 00H, 4DH, 11H, aaH, bbH, ccH, ddH, ssH, ttH, uuH, vvH, sum

<u>Status</u>
F7H

<u>Byte</u>	<u>Remarks</u>
F0H	Exclusive status
41H	ID number (Roland)
dev	device ID (dev: 10H fixed)
00H	model ID
4DH	model ID (VK-8)
11H	command ID (RQ1)
aaH	address MSB
bbH	address
ccH	address
ddH	address LSB
ssH	size MSB
ttH	size
uuH	size
vvH	size LSB
sum	checksum
F7H	EOX (End Of Exclusive)

- * The amount of data can be transmitted at one time depends on the type of data, and data will be transmitted from the specified starting address and size. Refer to the address and size given in "Parameter Address Map" (p. 74).
- * For the address, size, and checksum, refer to "Examples of system exclusive messages and calculating the checksum" (p. 76).
- * Regarding the checksum, please refer to page 76.

●Data Set 1 DT1

This message transmits the actual data, and is used when you wish to set the data of the receiving device.

<u>Status</u>	<u>data byte</u>
F0H	41H, dev, 00H, 4DH, 12H, aaH, bbH, ccH, ddH, eeH, ... ffH, sum

<u>Status</u>
F7H

<u>Byte</u>	<u>Remarks</u>
F0H	Exclusive status
41H	ID number (Roland)
dev	device ID (dev: 10H fixed)
00H	model ID
4DH	model ID (VK-8)
12H	command ID (DT1)
aaH	address MSB
bbH	address
ccH	address
ddH	address LSB
eeH	data : The actual data to be transmitted. Multi-byte data is transmitted in the order of the address.
:	:
ffH	data
sum	checksum
F7H	EOX (End Of Exclusive)

- * For the address, size, and checksum, refer to "Examples of System Exclusive Messages and Calculating the Checksum" (p. 76).
- * Data whose size is greater than 128 bytes should be divided into packets of 128 bytes or less and transmitted. Successive "Data Set 1" messages should have at least 40 ms of time interval between them.
- * Regarding the checksum, please refer to page 76.

2. Transmitted Data

- * Messages that affect the system or the entire organ part are transmitted on the channel specified by CONTROL MIDI CH. (p. 54).
- * Messages related to individual Organ parts are transmitted on the channels specified by UPPER/LOWER/PEDAL ORGAN MIDI CH. (p. 54).
- * Messages related to the Other Tones part are transmitted on the channel specified by OTHER TONES MIDI CH. (p. 54).

■Channel Voice Messages

●Note off

<u>Status</u>	<u>2nd byte</u>	<u>3rd byte</u>
8nH	kkH	vvH
n = MIDI channel number:		0H-FH (ch.1-ch.16)
kk = note number:		1EH-65H (30-101) (Organ Part)
		00H-7FH (0-127) (Other Tones Part)
vv = note off velocity:		40H (64) (Organ Part)
		00H-7FH (0-127) (Other Tones Part)

●Note on

<u>Status</u>	<u>2nd byte</u>	<u>3rd byte</u>
9nH	kkH	vvH
n = MIDI channel number:		0H-FH (ch.1-ch.16)
kk = note number:		1EH-65H (30-101) (Organ Part)
		00H-7FH (0-127) (Other Tones Part)
vv = note on velocity:		64H (100) (Organ Part)
		01H-7FH (1-127) (Other Tones Part)

●Control Change

○Volume (Controller number 7)

<u>Status</u>	<u>2nd byte</u>	<u>3rd byte</u>
BnH	07H	vvH
n = MIDI channel number :		0H - FH (ch.1 - ch.16)
vv = volume :		00H - 7FH (0 - 127)
		* Transmitted in accord with movement of the panel's [OTHER TONES LEVEL] knob on the channel specified by OTHER TONES MIDI CH. (p. 54).

○Expression (Controller number 11)

<u>Status</u>	<u>2nd byte</u>	<u>3rd byte</u>
BnH	0BH	vvH
n = MIDI channel number :		0H - FH (ch.1 - ch.16)
vv = expression :		10H - 7FH (10 - 127) (Organ Part)
		00H - 7FH (0 - 127) (Other Tones Part)
		* Transmitted when the expression pedal is operated, on the channel specified by CONTROL MIDI CH. (p. 54) and OTHER TONES MIDI CH. (p. 54).

○General Purpose Controller 1 (Controller number 16) (Other Tones Glide)

<u>Status</u>	<u>2nd byte</u>	<u>3rd byte</u>
BnH	10H	vvH
n = MIDI channel number :		0H - FH (ch.1 - ch.16)
vv = control value :		00H - 7FH (0 - 127) 0-63 = OFF, 64-127 = ON
		* Not received when MIDI GENERAL CONTROLLERS SWITCH (p. 53) is OFF.

○General Purpose Controller 2 (Controller number 17) (Wheel Brake)

<u>Status</u>	<u>2nd byte</u>	<u>3rd byte</u>
BnH	11H	vvH
n = MIDI channel number :		0H - FH (ch.1 - ch.16)
vv = control value :		00H - 7FH (0 - 127) 0-63 = OFF, 64-127 = ON
		* Not received when MIDI GENERAL CONTROLLERS SWITCH (p. 53) is OFF.

○Hold 1 (Controller number 64)

<u>Status</u>	<u>2nd byte</u>	<u>3rd byte</u>
BnH	40H	vvH
n = MIDI channel number :		0H - FH (ch.1 - ch.16)
vv = control value :		00H - 7FH (0 - 127) 0-63 = OFF, 64-127 = ON

○General Purpose Controller 5 (Controller number 80) (Rotary Speed)

<u>Status</u>	<u>2nd byte</u>	<u>3rd byte</u>
BnH	50H	vvH
n = MIDI channel number:		0H - FH (ch.1 - ch.16)
vv = control value:		00H - 7FH (0 - 127)
		* Not received when MIDI GENERAL CONTROLLERS SWITCH (p. 53) is OFF.

○General Purpose Controller 6 (Controller number 81) (Rotary Brake)

<u>Status</u>	<u>2nd byte</u>	<u>3rd byte</u>
BnH	51H	vvH
n = MIDI channel number:		0H - FH (ch.1 - ch.16)
vv = control value:		00H - 7FH (0 - 127) 0-63 = SPIN, 64-127 = BRAKE
		* Not received when MIDI GENERAL CONTROLLERS SWITCH (p. 53) is OFF.

MIDI Implementation

● Program Change

Status 2nd byte
 CnH ppH
 n = MIDI channel number : 0H - FH (ch.1 - ch.16)
 pp = program number : 00H - 3FH (prog.1 - prog.64) (Preset)
 00H - 07H (prog.1 - prog.8) (Other Tones)

* Not received when MIDI PROGRAM CHANGE SWITCH is OFF (p. 53) (factory setting: ON).

■ System Realtime Message

● Active sensing

Status
 FEH
 * This will be transmitted constantly at intervals of approximately 250 ms.

■ System Exclusive Messages

“Identity Reply” and “Data Set 1 (DT1)” are the only System Exclusive messages transmitted by VK-8.

When an appropriate “Identity Request Message” and “Data Request 1 (RQ1)” message are received, the requested internal data will be transmitted.

● Identity Reply

Status Data byte
 F0H 7EH, dev, 06H, 02H, 41H, 4DH, 01H, 00H, 00H, 01H, 00H, 02H
 Status
 F7H

Byte	Explanation
FOH	Exclusive status
7EH	ID number (universal non-realtime message)
dev	Device ID (use the same as the device ID of Roland)
06H	Sub ID#1 (General Information)
02H	Sub ID#2 (Identity Reply)
41H	ID number (Roland)
4DH	Device family code (LSB)
01H	Device family code (MSB)
00H	Device family number code (LSB)
00H	Device family number code (MSB)
00H	Software revision level
01H	Software revision level
00H	Software revision level
00H	Software revision level
F7H	EOX (End of Exclusive)

* Reply the message by the unique device ID (dev) when the device has received the “Identity Request Message” in the Broadcast.

● Data Set1 DT1

Status data byte
 F0H 41H, dev, 00H, 4DH, 12H, aaH, bbH, ccH, ddH, eeH... eeH, sum
 Status
 F7H

Byte	Remarks
F0H	Exclusive status
41H	ID number (Roland)
dev	device ID (dev: 10H fixed)
00H	model ID
4DH	model ID (VK-8)
12H	command ID (DT1)
aaH	address MSB
bbH	address
ccH	address
ddH	address LSB
eeH	data: The actual data to be transmitted. Multi-byte data is transmitted in the address order.
:	:
ffH	data
sum	checksum
F7H	EOX (End Of Exclusive)

* For the address, size, and checksum, refer to “Examples of System Exclusive Messages and Calculating the Checksum” (p. 76).
 * Large amounts of data must be divided into packets of 128 bytes or less, and transmitted at intervals of approximately 40 ms.
 * Regarding the checksum, please refer to page 76.

3. Parameter address map (MODEL ID = 00 4DH)

Transmission of “#” marked address is divided to some packets. For example, ABH in hexadecimal notation will be divided to 0AH and 0BH, and is sent/received in this order.

Start Address	Description
00 00 00 00	System
10 00 00 00 :	Temporary Preset
20 00 00 00 20 01 00 00 :	User Preset (01) User Preset (02)
20 3F 00 00	User Preset (64)

• System

Offset Address	Description
00 00 00 00 01 00 00 02 00 00 03 00	System Common System MIDI System Organ System FX

• Preset

Offset Address	Description
00 00 00 00 10 00 00 20 00	Preset Common Preset Organ Preset FX

• System Common

Offset Address	Description
# 00 00	0000 aaaa 0000 bbbb 0000 cccc 0000 dddd Master Tune (24 - 2024) -100.0 - 100.0 [cent]
00 04	0000 aaaa Key Transpose (58 - 69) -6 - +5
00 05	0000 aaaa Foot Control Assign (0 - 10) ROTARY SLOW/FAST, ROTARY SPEED, ROTARY BRAKE ON/OFF, OTHER TONES GLIDE, PRESET UP, OVERDRIVE, OTHER TONES EXPRESSION, D BEAM SYNC, CRESCENDO, RING MODULATION, TONE WHEEL BRAKE, SPRING SHOCK
00 06	0000 000a Foot Control Polarity (0 - 1) STANDARD, REVERSE
00 07	0000 000a Hold Pedal Polarity (0 - 1) STANDARD, REVERSE
00 00 00 08	Total Size

• System MIDI

Offset Address	Description
00 00	0000 aaaa Control Channel (0 - 15) 1 - 16
00 01	0000 aaaa Upper Channel (0 - 15) 1 - 16
00 02	0000 aaaa Lower Channel (0 - 15) 1 - 16
00 03	0000 aaaa Pedal Channel (0 - 15) 1 - 16
00 04	0000 aaaa Other Tones Channel (0 - 15) 1 - 16
00 05	0000 aaaa Drums Channel (0 - 15) 1 - 16
00 06	0000 aaaa Spring Shock Channel (0 - 15) 1 - 16
00 07	0000 000a Sound Controllers Switch (0 - 1) OFF, ON
00 08	0000 000a General Controllers Switch (0 - 1) OFF, ON
00 09	0000 000a Program Change Switch (0 - 1) OFF, ON
00 00 00 0A	Total Size

• System Organ

Offset Address	Description		
00 00	000a aaaa	On Click Level	(0 - 31)
00 01	000a aaaa	Off Click Level	(0 - 31)
00 02	0000 aaaa	Percussion Soft Level	(0 - 15)
00 03	0000 aaaa	Percussion Norm Level	(0 - 15)
00 04	0aaa aaaa	Percussion Slow Time	(0 - 127)
00 05	0aaa aaaa	Percussion Fast Time	(0 - 127)
00 06	0000 aaaa	Percussion Recharge Time	(0 - 10)
00 07	0aaa aaaa	Percussion H.Bar Level	(0 - 127)
00 08	0aaa aaaa	D-Beam Crescendo	(0 - 127)
00 09	0aaa aaaa	Organ Crescendo	(0 - 127)
00 00 00 0A	Total Size		

• System FX

Offset Address	Description		
00 00	0aaa aaaa	Rotary Woofer Level	(0 - 127)
00 01	0aaa aaaa	Rotary Tweeter Level	(0 - 127)
00 02	0aaa aaaa	Rotary Woofer Rise Time	(0 - 127)
00 03	0aaa aaaa	Rotary Tweeter Rise Time	(0 - 127)
00 04	0aaa aaaa	Rotary Woofer Fall Time	(0 - 127)
00 05	0aaa aaaa	Rotary Tweeter Fall Time	(0 - 127)
00 06	0aaa aaaa	Rotary Woofer Speed Fast	(0 - 127)
00 07	0aaa aaaa	Rotary Tweeter Speed Fast	(0 - 127)
00 08	0aaa aaaa	Rotary Woofer Speed Slow	(0 - 127)
00 09	0aaa aaaa	Rotary Tweeter Speed Slow	(0 - 127)
00 0A	0000 aaaa	Rotary Woofer Spread	(0 - 10)
00 0B	0000 aaaa	Rotary Tweeter Spread	(0 - 10)
00 0C	0000 aaaa	Rotary Mic Distance	(0 - 10)
00 0D	0000 aaaa	Rotary Randomize	(0 - 10)
00 0E	0000 aaaa	EQ Bass	(59 - 69) -5 - +5
00 0F	0000 aaaa	EQ Middle	(59 - 69) -5 - +5
00 10	0000 aaaa	EQ Treble	(59 - 69) -5 - +5
00 00 00 11	Total Size		

• Preset Common

Offset Address	Description		
00 00	0000 000a	Keyboard Split Switch	(0 - 1) OFF, ON
00 01	0aaa aaaa	Keyboard Split Point	(0 - 127) C-1 - G9
00 02	0000 000a	Hold Pedal Assign	(0 - 1) ORGAN & OTHER TONES, OTHER TONES
00 03	0000 000a	D-Beam Switch	(0 - 1) OFF, ON
00 04	0000 0aaa	D-Beam Assign	(0 - 4) CRESCENDO, ROTARY SPEED, RING MODULATION, TONE WHEEL BRAKE, SPRING SHOCK
00 05	0000 000a	D-Beam Rotary Speed Mode	(0 - 1) SLOW/FAST, COTINUOUS
00 06	0000 000a	Rotary Fast/Slow Status	(0 - 1) SLOW, FAST
00 07	0000 00aa	Expression Mode	(0 - 2) NORMAL, OTHER TONES CRESCENDO, ORGAN CRESCENDO
00 08	0000 000a	Other Tones Switch	(0 - 1) OFF, ON
00 09	0000 0aaa	Other Tones PC Number	(0 - 7) 1 - 8
00 0A	0aaa aaaa	Other Tones Level	(0 - 127)
00 0B	0000 0aaa	Other Tones Octave Shift	(61 - 67) -3 - +3
00 0C	0000 00aa	Other Tones Assign	(0 - 2) UPPER, LOWER, PEDAL
00 00 00 0D	Total Size		

• Preset Organ

Offset Address	Description		
00 00	0000 aaaa	Upper Harmonic Bar 16'	(0 - 8)
00 01	0000 aaaa	Upper Harmonic Bar 5-1/3'	(0 - 8)
00 02	0000 aaaa	Upper Harmonic Bar 8'	(0 - 8)
00 03	0000 aaaa	Upper Harmonic Bar 4'	(0 - 8)
00 04	0000 aaaa	Upper Harmonic Bar 2-2/3'	(0 - 8)
00 05	0000 aaaa	Upper Harmonic Bar 2'	(0 - 8)
00 06	0000 aaaa	Upper Harmonic Bar 1-3/5'	(0 - 8)
00 07	0000 aaaa	Upper Harmonic Bar 1-1/3'	(0 - 8)
00 08	0000 aaaa	Upper Harmonic Bar 1'	(0 - 8)
00 09	0000 aaaa	Lower Harmonic Bar 16'	(0 - 8)
00 0A	0000 aaaa	Lower Harmonic Bar 5-1/3'	(0 - 8)
00 0B	0000 aaaa	Lower Harmonic Bar 8'	(0 - 8)
00 0C	0000 aaaa	Lower Harmonic Bar 4'	(0 - 8)
00 0D	0000 aaaa	Lower Harmonic Bar 2-2/3'	(0 - 8)
00 0E	0000 aaaa	Lower Harmonic Bar 2'	(0 - 8)
00 0F	0000 aaaa	Lower Harmonic Bar 1-3/5'	(0 - 8)
00 10	0000 aaaa	Lower Harmonic Bar 1-1/3'	(0 - 8)
00 11	0000 aaaa	Lower Harmonic Bar 1'	(0 - 8)
00 12	0000 aaaa	Pedal Harmonic Bar 16'	(0 - 8)
00 13	0000 aaaa	Pedal Harmonic Bar 8'	(0 - 8)
00 14	0000 000a	Percussion Switch	(0 - 1) OFF, ON
00 15	0000 000a	Percussion Harmonic	(0 - 1) 2ND, 3RD
00 16	0000 000a	Percussion Soft	(0 - 1) NORM, SOFT
00 17	0000 000a	Percussion Slow	(0 - 1) FAST, SLOW
00 18	0000 00aa	Wheel Type	(0 - 3) VINTAGE 1, VINTAGE 2, CLEAN
00 19	0aaa aaaa	Leakage Level	(0 - 127)
00 00 00 1A	Total Size		

• Preset FX

Offset Address	Description		
00 00	0000 000a	Vibrato Chorus Switch	(0 - 1) OFF, ON
00 01	0000 0aaa	Vibrato Chorus Type	(0 - 5) V-1, V-2, V-3, C-1, C-2, C-3
00 02	0000 00aa	Vibrato Chorus Vintage	(0 - 2) '50, '60, '70
00 03	0aaa aaaa	Rotary Speed	(0 - 127)
00 04	0000 000a	Rotary Brake	(0 - 1) OFF, ON
00 05	0000 000a	Rotary Bypass	(0 - 1) OFF, ON
00 06	0000 00aa	Amp & Speaker	(0 - 3) TYPE I, TYPE II, TYPE III, TYPE IV
00 07	0aaa aaaa	Overdrive	(0 - 127) OFF, 1 - 127
00 08	0aaa aaaa	Tone	(1 - 127) -63 - +63
00 09	0000 000a	Ring Modulator Switch	(0 - 1) OFF, ON
00 0A	0aaa aaaa	Ring Modulator Frequency	(0 - 127)
00 0B	0000 00aa	Reverb Type	(0 - 3) ROOM, HALL, CHURCH, SPRING
00 0C	0aaa aaaa	Reverb Level	(0 - 127)
00 0D	0aaa aaaa	Reverb Time	(0 - 127)
00 0E	0aaa aaaa	Chorus Level	(0 - 127)
00 00 00 0F	Total Size		

MIDI Implementation

4. Supplementary material

Decimal/Hexadecimal Table

MIDI uses 7-bit hexadecimal values to indicate data values and the address and size of exclusive messages. The following table shows

the correspondence between decimal and hexadecimal numbers.

* Hexadecimal values are indicated by a following 'H.'

D	H	D	H	D	H	D	H
0	00H	32	20H	64	40H	96	60H
1	01H	33	21H	65	41H	97	61H
2	02H	34	22H	66	42H	98	62H
3	03H	35	23H	67	43H	99	63H
4	04H	36	24H	68	44H	100	64H
5	05H	37	25H	69	45H	101	65H
6	06H	38	26H	70	46H	102	66H
7	07H	39	27H	71	47H	103	67H
8	08H	40	28H	72	48H	104	68H
9	09H	41	29H	73	49H	105	69H
10	0AH	42	2AH	74	4AH	106	6AH
11	0BH	43	2BH	75	4BH	107	6BH
12	0CH	44	2CH	76	4CH	108	6CH
13	0DH	45	2DH	77	4DH	109	6DH
14	0EH	46	2EH	78	4EH	110	6EH
15	0FH	47	2FH	79	4FH	111	6FH
16	10H	48	30H	80	50H	112	70H
17	11H	49	31H	81	51H	113	71H
18	12H	50	32H	82	52H	114	72H
19	13H	51	33H	83	53H	115	73H
20	14H	52	34H	84	54H	116	74H
21	15H	53	35H	85	55H	117	75H
22	16H	54	36H	86	56H	118	76H
23	17H	55	37H	87	57H	119	77H
24	18H	56	38H	88	58H	120	78H
25	19H	57	39H	89	59H	121	79H
26	1AH	58	3AH	90	5AH	122	7AH
27	1BH	59	3BH	91	5BH	123	7BH
28	1CH	60	3CH	92	5CH	124	7CH
29	1DH	61	3DH	93	5DH	125	7DH
30	1EH	62	3EH	94	5EH	126	7EH
31	1FH	63	3FH	95	5FH	127	7FH

D: decimal

H: hexadecimal

* Decimal expressions such as used for MIDI channel, Bank Select, and Program Change will be the value 1 greater than the decimal value given in the above table.

* Since each MIDI byte carries 7 significant data bits, each byte can express a maximum of 128 different values. Data for which higher resolution is required must be transmitted using two or more bytes. For example a value indicated as a two-byte value of aa bbH would have a value of aa x 128 + bb.

* For a signed number (±), 00H = -64, 40H = ±0, and 7FH = +63. I.e., the decimal equivalent will be 64 less than the decimal value given in the above table. For a two-byte signed number, 00 00H = -8192, 40 00H = ±0, and 7F 7FH = +8191. For example the decimal expression of aa bbH would be aa bbH - 40 00H = aa x 128 + bb - 64 x 128.

Hexadecimal notation in two 4-bit units is used for data indicated as "nibbled." The nibbled two-byte value of 0a 0b H would be a x 16 + b.

<Example1> What is the decimal equivalent of 5AH?

From the above table, 5AH = 90.

<Example2> What is the decimal equivalent of the 7-bit hexadecimal values 12 34H?

From the above table, 12H = 18 and 34H = 52

Thus, 18 x 128 + 52 = 2356

Examples of Actual MIDI Messages

<Example1> 93 3E 5F

9n is the Note On status and 'n' is the MIDI channel number. Since 3H = 3, 3EH = 62, and 5FH = 95, this is a Note On message of MIDI CH = 4, note number 62 (note name D4) and velocity 95.

<Example2> C0 25

CnH is the Program Change status and 'n' is the MIDI channel number. Since 0H = 0, and 25H = 37, this is a Program Change message of MIDI CH = 1, Program number 38

Examples of System Exclusive Messages and Calculating the Checksum

Roland exclusive messages (RQ1, DT1) are transmitted with a checksum at the end of the data (before F7) to check that the data was received correctly. The value of the checksum is determined by the address and data (or size) of the exclusive message.

How to calculate the checksum

The checksum consists of a value whose lower 7 bits are 0 when the address, size and checksum itself are added. The following formula shows how to calculate the checksum when the exclusive message to be transmitted has an address of aa bb cc ddH, and data or size of ee ffH.

$$aa + bb + cc + dd + ee + ff = \text{total}$$

$$\text{total} \div 128 = \text{quotient} \dots \text{remainder}$$

$$128 - \text{remainder} = \text{checksum}$$

<Example1> Turn the Temporary Preset Organ percussion switch ON (DT1).

The "Parameter address map" indicates that the starting address of the Temporary Preset is 10 00 00 00H, that the Preset Organ Parameter offset address is 10 00H, and that the "PERCUSSION SWITCH" address is 00 14H. Thus, the address is:

```

10 00 00 00H
+ )      10 00H
-----
10 00 10 14H

```

Since "ON" is parameter value 01H,

F0 41 10 00 4D 12 10 00 10 14 01 ?? F7

(1) (2) (3) (4) (5) address data checksum (6)

(1) Exclusive status (2) ID number (Roland) (3) device ID(17)
(4) model ID (VK-8) (5) command ID (DT1) (6) EOX

Next we calculate the checksum.

$$10H + 00H + 10H + 14H + 01H = 16 + 0 + 16 + 20 + 1 = 53 \text{ (sum)}$$

$$53 \text{ (total)} \div 128 = 0 \text{ (quotient)} \dots 53 \text{ (remainder)}$$

$$\text{checksum} = 128 - 53 \text{ (quotient)} = 75 = 4BH$$

This means that the message transmitted will be F0 41 10 00 4D 12 10 00 10 14 01 4B F7.

<Example2> Obtain preset organ parameter data for User Preset: 02 (RQ1).

The "Parameter address map" indicates that the starting address of USER: 02 is 20 01 00 00H, and that the offset address of Organ Parameter is 10 00H. Thus, the address is:

```

20 01 00 00H
+ )      10 00H
-----
20 01 10 00H

```

Since the size of the Performance Part is 00 00 00 1AH,

F0 41 10 00 4D 11 20 01 10 00 00 00 00 1A ?? F7

(1) (2) (3) (4) (5) address data checksum (6)

(1) Exclusive status (2) ID number (Roland) (3) Device ID (17)
(4) Model ID (VK-8) (5) Command ID (RQ1) (6) EOX

Next we calculate the checksum.

$$20H + 01H + 10H + 00H + 00H + 00H + 00H + 1AH =$$

$$32 + 1 + 16 + 0 + 0 + 0 + 0 + 26 = 75 \text{ (sum)}$$

$$75 \text{ (total)} \div 128 = 0 \text{ (product)} \dots 75 \text{ (remainder)}$$

$$\text{checksum} = 128 - 75 \text{ (remainder)} = 53 = 35H$$

Thus, a message of F0 41 10 00 4D 11 20 01 10 00 00 00 00 1A 35 F7 would be transmitted.

MIDI Implementation Chart

Function...		Transmitted	Recognized			Remarks
			SEQUENCER MODE	KEYBOARD MODE		
Basic Channel	Default Changed	1-16 1-16	1-16 1-16	1-16 X		
Mode	Default Messages Altered	Mode 3 X *****	Mode 3 X	Mode 1 X		
Note Number :	True Voice	30-101 *****	0-127 36-96 (UPPER/LOWER) 36-61 (PEDAL) 0-127 (Other Tones)	0-127 *1 36-96 (UPPER/LOWER) 36-61 (PEDAL) 0-127 (Other Tones)		
Velocity	Note On Note Off	O O	O O	O *1 O		
After Touch	Key's Channel's	X X	X X	X X		
Pitch Bend		X	O *2	X *3		
Control Change	1 6, 38 7 10 11 16 17 70-78 80 81 64 100, 101	X X O *2 X O *4 O *6 O *7 *8 X O O O X	O *2 O *2 O *2 O *2 O *4 O *6 O *7 *8 O *8 *9 O O *2 O O	O *3 O *3 O *3 O *3 O *5 O *3 O *7 O *9 O *12 O *13 O *10 O *3	Modulation Data entry Volume Panpot Expression General purpose controller 1 General purpose controller 2 Sound controller General purpose controller 5 General purpose controller 6 Hold 1 RPN LSB, MSB	
Program Change :	True Number	0-63 *****	O 0-63 (Other Tones: 0-7)	O *11	Program No. 1-64	
System Exclusive		O	O	O		
System Common :	Song Position Song Select Tune Request	X X X	X X X	X X X	Processed as 0	
System Real Time :	Clock Commands	X X	X X	X X		
Aux Messages :	All Sound Off Reset All Controllers Local On/Off All Notes Off Active Sensing System Reset	O X X X O X	O O X O O X	X X X X O X		
Notes	<p>*1 The messages will be received as messages for sub keyboard part, regardless of their channel number.</p> <p>*2 Only OTHER TONES part</p> <p>*3 When OTHER TONES is assigned to KEYBOARD IN or PEDAL IN jack, the message of the OTHER TONES will be received.</p> <p>*4 The Messages will be received on the channel specified by Control MIDI Channel and Other Tones MIDI Channel.</p> <p>*5 Received Data will be handled in the same way as the EXPRESSION PEDAL jack of the VK-8 itself.</p> <p>*6 OTHER TONES Glide</p> <p>*7 Wheel Brake</p> <p>*8 The Messages will be received on the channel specified by Control MIDI Channel.</p> <p>*9 Harmonic Bar</p> <p>*10 Received Data will be handled in the same way as the HOLD PEDAL jack of the VK-8 itself.</p> <p>*11 Preset will be switched by received MIDI message.</p> <p>*12 Rotary Speed</p> <p>*13 Rotary Brake</p>					

Mode 1 : OMNI ON, POLY
Mode 3 : OMNI OFF, POLY

Mode 2 : OMNI ON, MONO
Mode 4 : OMNI OFF, MONO

O : Yes
X : No

Main Specification

VK-8: Combo Organ

● Keyboard

Waterfall keyboard 61 keys (with velocity)

● Sound Generator

Organ: Virtual Tone Wheel Method

OTHER TONES: PCM Sound Generator

● Part

Upper Organ, Lower Organ, Pedal Organ, Other Tones

● Maximum Polyphony

Organ: Full Polyphony

Orchestral: 64 voices

● Organ

Tone wheel

VINTAGE 1, VINTAGE 2, CLEAN

Leakage Level

Vibrato and Chorus

V-1, V-2, V-3, C-1, C-2, C-3

Percussion

SECOND, THIRD, SOFT, SLOW

AMP simulator

TYPE I, TYPE II, TYPE III

Overdrive

Tone

Reverb

ROOM, HALL, CHRCH, SPRING

Reverb Level

D BEAM

CRESCENDO, ROTARY SPEED, RING MODULATOR, TONE WHEEL BRAKE, SPRING SHOCK

● OTHER TONES

PIANO, ELECTRIC PIANO 1, ELECTRIC PIANO 2, STRINGS, JAZZ SCAT, CHOIR, SYNTH, BRASS

Effect

Chorus, Reverb

● Internal Memory

Preset memory: 64 (User Memory)

● Control

Harmonic Bar

16', 5-1/3', 8', 4', 2-2/3', 2', 1-3/5', 1-1/3', 1'

Harmonic Bar Part

[PEDAL] button, [LOWER] button, [UPPER] button

TONE WHEEL

[LEAKAGE] knob, [TONE WHEEL] button

VIBRATO AND CHORUS

VIBRATO AND CHORUS [ON] button,

[VIBRATO AND CHORUS] rotary knob

D BEAM

D BEAM Controller, D BEAM [ON] button, [D BEAM] button

AMPLIFIER

[OVERDRIVE] knob, [AMPLIFIER] button, [TONE] knob

REVERB

REVERB [LEVEL] knob, [REVERB] button

OTHER TONES

[PIANO] button, [ELECTRIC PIANO 1] button,

[ELECTRIC PIANO 2] button, [STRINGS] button,

[JAZZ SCAT] button, [CHOIR] button, [SYNTH] button,

[BRASS] button

[OTHER TONES LEVEL] knob

PRESET

[WRITE] button, [BANK] button, [PRESET] button,

[1]-[8] buttons

PERCUSSION

[SECOND] button, [THIRD] button, [SOFT] button,

[SLOW] button

ROTARY SOUND

ROTARY [ON] button, [BRAKE] button, [SLOW/FAST] button

Others

[SPLIT] button, [H-BAR MANUAL] button,

[MASTER VOLUME] knob

● Connectors

OUTPUT Jacks (L (MONO)/R): 1/4 inch TRS phone type

PHONES Jack: Stereo 1/4 inch phone type

EXPRESSION PEDAL Jack

HOLD PEDAL Jack

CONTROL PEDAL Jack

MIDI Connectors (KEYBOARD IN, PEDAL IN, OUT)

ROTARY TONE CABINET Connector

AC Inlet

● Power

AC 117 V, AC 230 V, AC 240 V

● Power Consumption

15 W

● Finish

Top Panel: Simulated Walnut

Side Panel: Natural Wood Walnut Finish

● Dimensions

1160 (W) x 344 (D) x 109 (H) mm

45-11/16 (W) x 13-9/16 (D) x 4-5/16 (H) inches

● Weight

14.5 kg / 32 lbs

● Accessories

Owner's Manual, Edit Mode Quick Reference, Power cable

* *In the interest of product improvement, the specifications and/or appearance of this unit are subject to change without prior notice.*

Index

A	
Active Expression function	39
Ambience	37
Amp Type	14, 33
B	
BANK	45
Bulk Dump	61
C	
Chorus	31
Click Noise	51
Connection	
Amp	17
Expression Pedal	18
External Keyboard	59
External Sequencer	60–61
Headphones	17
Pedal Keyboard	18, 59
Pedal Switch	18
Power Cord	16
Rotary Speaker	62
Speaker	17
Control MIDI Channel	54
Control Pedal	40
D	
D BEAM Controller	34
D BEAM ROTARY SPEED MODE	57
Demo Song	21
Drum MIDI Channel	54
E	
Edit Mode	47
EQ BASS	55
EQ MIDDLE	55
EQ TREBLE	55
Equalizer	55
Expression Pedal	39
F	
Factory Reset	20
Feet	25–26
Folded Back	26
FOOT CONTROL POLARITY	56
H	
Harmonic Bar	24
Harmonic bars	14
Hold Pedal	42
HOLD PEDAL ASSIGN	57
HOLD PEDAL POLARITY	56
K	
Key Click	13
KEY TRANSPOSE	55
L	
Layer	43
Leakage Level	27
Leakage Noise	27
LOCAL CONTROL	53
Lower Organ MIDI Channel	54
Lower Part	38
M	
MASTER TUNE	55
Master Volume	19
Memory	15
MIDI	58
MIDI Channel	54, 58
MIDI GENERAL CONTOROLLERS SWITCH	53
MIDI PROGRAM CHANGE SWITCH	53
MIDI SOUND CONTROLLERS SWITCH	53
MIDI THRU	53
O	
OFF CLICK LEVEL	51
ON CLICK LEVEL	51
Organ Voice	23
OTHER TONES	14, 43–44
OTHER TONES CHORUS LEVEL	57
Other Tones MIDI Channel	54
OTHER TONES OCTAVE SHIFT	57
OTHER TONES PART ASSIGN	57
OUTPUT jacks	17
Overdrive	14, 33
P	
Parameter	47
Pedal Organ MIDI Channel	54
Percussion	13, 28
PERCUSSION FAST TIME	51
PERCUSSION H-BAR LEVEL	52
PERCUSSION NORMAL LEVEL	51
PERCUSSION RECHARGE TIME	51
PERCUSSION SLOW TIME	51
PERCUSSION SOFT LEVEL	51
Power On	19
Preset	22, 45–46
Copy	46
Save	45–46

Index

Preset Memory 15

R

Reverb 14, 37

REVERB TIME 57

Reverb Type 37

Ring Modulator 34–35, 41

Rotary 14

ROTARY MIC DISTANCE 50

ROTARY RANDOMIZE 50

Rotary Sound 32

ROTARY TWEETER FALL TIME 50

ROTARY TWEETER LEVEL 50

ROTARY TWEETER RISE TIME 50

ROTARY TWEETER SPEED FAST 50

ROTARY TWEETER SPEED SLOW 50

ROTARY TWEETER SPREAD 50

ROTARY WOOFER FALL TIME 50

ROTARY WOOFER LEVEL 50

ROTARY WOOFER RISE TIME 50

ROTARY WOOFER SPEED FAST 50

ROTARY WOOFER SPEED SLOW 50

ROTARY WOOFER SPREAD 50

S

Second Percussion 28

Single Trigger Algorithm 30

Slow Percussion 30

Soft Percussion 29

Split 38, 44

Split Point 38

Spring Reverb Shock 35

Spring Shock MIDI Channel 54

SUB KEYBOARD FUNCTION 58

System Memory 15

T

Third Percussion 28

Tone 14, 33

Tone Wheel 13

Tone wheel 27

Transpose 55

U

Upper Organ MIDI Channel 54

Upper Part 38

V

Vibrato 31

Vibrato and Chorus 14, 31

Virtual Tonewheel 13

W

Wheel Brake 34–35, 41

Wheel Type 27

MEMO

Information

When you need repair service, call your nearest Roland Service Center or authorized Roland distributor in your country as shown below.

AFRICA

EGYPT

Al Fanny Trading Office
9, EBN Hagar Al Askalany Street,
ARD El Golf, Heliopolis,
Cairo 11341, EGYPT
TEL: 20-2-417-1828

REUNION

Maison FO - YAM Marcel
25 Rue Jules Hermann,
Chaudron - BP79 97 491
Ste Clotilde Cedex,
REUNION ISLAND
TEL: (0262) 218-429

SOUTH AFRICA

**That Other Music Shop
(PTY) Ltd.**
11 Melle St., Braamfontein,
Johannesburg, SOUTH AFRICA

P.O.Box 32918, Braamfontein 2017
Johannesburg, SOUTH AFRICA
TEL: (011) 403 4105

Paul Bothner (PTY) Ltd.

17 Werdmuller Centre,
Main Road, Claremont 7708
SOUTH AFRICA

P.O.Box 23032, Claremont 7735,
SOUTH AFRICA
TEL: (021) 674 4030

ASIA

CHINA

**Roland Shanghai Electronics
Co., Ltd.**
5F, No.1500 Pingliang Road
Shanghai, CHINA
TEL: (021) 5580-0800

**Roland Shanghai Electronics
Co., Ltd.
(BEIJING OFFICE)**

10F, No.18 Anhuaxili
Chaoyang District, Beijing,
CHINA
TEL: (010) 6426-5050

HONG KONG

**Tom Lee Music Co., Ltd.
Service Division**
22-32 Pun Shan Street, Tsuen
Wan, New Territories,
HONG KONG
TEL: 2415 0911

INDIA

Rivera Digitech (India) Pvt. Ltd.
409, Nirman Kendra Mahalaxmi
Flats Compound Off. Dr. Edwin
Moses Road, Mumbai-400011,
INDIA
TEL: (022) 2493 9051

INDONESIA

PT Citra IntiRama
Jl. Cideng Timur No. 15J-150
Jakarta Pusat
INDONESIA
TEL: (021) 6324170

KOREA

Cosmos Corporation
1461-9, Seocho-Dong,
Seocho Ku, Seoul, KOREA
TEL: (02) 3486-8855

MALAYSIA

BENTLEY MUSIC SDN BHD
140 & 142, Jalan Bukit Bintang
55100 Kuala Lumpur, MALAYSIA
TEL: (03) 2144-3333

PHILIPPINES

G.A. Yupangco & Co. Inc.
339 Gil J. Puyat Avenue
Makati, Metro Manila 1200,
PHILIPPINES
TEL: (02) 899 9801

SINGAPORE

Swee Lee Company
150 Sims Drive,
SINGAPORE 387381
TEL: 6846-3676

CRISTOFORI MUSIC PTE

LTD
Blk 3014, Bedok Industrial Park E,
#02-2148, SINGAPORE 489980
TEL: 6243-9555

TAIWAN

**ROLAND TAIWAN
ENTERPRISE CO., LTD.**
Room 5, 9fl. No. 112 Chung Shan
N.Road Sec.2, Taipei, TAIWAN,
R.O.C.
TEL: (02) 2561 3339

THAILAND

Theera Music Co., Ltd.
330 Vereng NakornKasem, Soi 2,
Bangkok 10100, THAILAND
TEL: (02) 2248821

VIETNAM

Saigon Music
138 Tran Quang Khai St.,
District 1
Ho Chi Minh City
VIETNAM
TEL: (08) 844-4068

AUSTRALIA/ NEW ZEALAND

AUSTRALIA

**Roland Corporation
Australia Pty., Ltd.**
38 Campbell Avenue
Dee Why West. NSW 2099
AUSTRALIA
TEL: (02) 9982 8266

NEW ZEALAND

Roland Corporation Ltd.
32 Shaddock Street, Mount Eden,
Auckland, NEW ZEALAND
TEL: (09) 3098 715

CENTRAL/LATIN AMERICA

ARGENTINA

Instrumentos Musicales S.A.
Av. Santa Fe 2055
(1123) Buenos Aires
ARGENTINA
TEL: (011) 4508-2700

BRAZIL

Roland Brasil Ltda
Rua San Jose, 780 Sala B
Parque Industrial San Jose
Cotia - Sao Paulo - SP, BRAZIL
TEL: (011) 4615 5666

COSTA RICA

**JUAN BANSBACH
Instrumentos Musicales**
Ave.1. Calle 11, Apartado 10237,
San Jose, COSTA RICA
TEL: 258-0211

CHILE

Comercial Fancy II S.A.
Rut.: 96.919.420-1
Nataliel Cox #739, 4th Floor
Santiago - Centro, CHILE
TEL: (02) 688-9540

EL SALVADOR

OMNI MUSIC
75 Avenida Norte y Final
Alameda Juan Pablo II,
Edificio No.4010 San Salvador,
EL SALVADOR
TEL: 262-0788

MEXICO

Casa Veerkamp, s.a. de c.v.
Av. Toluca No. 323, Col. Olivar
de los Padres 01780 Mexico D.F.
MEXICO
TEL: (55) 5668-6699

PANAMA

SUPRO MUNDIAL, S.A.
Boulevard Andrews, Albrook,
Panama City, REP. DE PANAMA
TEL: 315-0101

PARAGUAY

**Distribuidora De
Instrumentos Musicales**
J.E. Olear y ESQ. Manduvira
Asuncion PARAGUAY
TEL: (021) 492-124

URUGUAY

Todo Musica S.A.
Francisco Acuna de Figueroa 1771
C.P.: 11.800
Montevideo, URUGUAY
TEL: (02) 924-2335

VENEZUELA

Musiland Digital C.A.
Av. Francisco de Miranda,
Centro Parque de Cristal, Nivel
C2 Local 20 Caracas
VENEZUELA
TEL: (212) 285-8586

EUROPE

AUSTRIA

Roland Austria GES.M.B.H.
Siemensstrasse 4, P.O. Box 74,
A-6063 RUM, AUSTRIA
TEL: (0512) 26 44 260

BELGIUM/HOLLAND/ LUXEMBOURG

Roland Benelux N. V.
Houtstraat 3, B-2260, Oevel
(Westerlo) BELGIUM
TEL: (014) 575811

DENMARK

Roland Scandinavia A/S
Nordhavnsvej 7, Postbox 880,
DK-2100 Copenhagen
DENMARK
TEL: 3916 6200

FRANCE

Roland France SA
4, Rue Paul Henri SPAAK,
Parc de l'Esplanade, F 77 462 St.
Thibault, Lagny Cedex FRANCE
TEL: 01 600 73 500

FINLAND

**Roland Scandinavia As,
Filial Finland**
Elannontie 5
FIN-01510 Vantaa, FINLAND
TEL: (0)9 68 24 020

GERMANY

**Roland Elektronische
Musikinstrumente HmbH.**
Oststrasse 96, 22844 Norderstedt,
GERMANY
TEL: (040) 52 60090

GREECE

STOLLAS S.A.
Music Sound Light
155, New National Road
Patras 26442, GREECE
TEL: 2610 435400

HUNGARY

Roland East Europe Ltd.
Warehouse Area "DEPO" PE.83
H-2046 Torokbalint, HUNGARY
TEL: (23) 511011

IRELAND

Roland Ireland
Audio House, Belmont Court,
Donnybrook, Dublin 4,
Republic of IRELAND
TEL: (01) 2603501

ITALY

Roland Italy S. p. A.
Viale delle Industrie 8,
20020 Arese, Milano, ITALY
TEL: (02) 937-78300

NORWAY

**Roland Scandinavia Avd.
Kontor Norge**
Lilleakerveien 2 Postboks 95
Lilleaker N-0216 Oslo
NORWAY
TEL: 2273 0074

POLAND

P. P. H. Brzostowicz
UL. Gibraltarska 4,
PL-03664 Warszawa POLAND
TEL: (022) 679 44 19

PORTUGAL

**Tecnologias Musica e Audio,
Roland Portugal, S.A.**
Cais Das Pedras, 8/9-1 Dto
4050-465 PORTO
PORTUGAL
TEL: (022) 608 00 60

ROMANIA

FBS LINES
Piata Libertatii 1,
RO-4200 Gheorgheni
TEL: (095) 169-5043

RUSSIA

MuTek
3-Bogatyrskaya Str. 1.k.1
107 564 Moscow, RUSSIA
TEL: (095) 169 5043

SPAIN

**Roland Electronics
de España, S. A.**
Calle Bolivia 239, 08020
Barcelona, SPAIN
TEL: (93) 308 1000

SWEDEN

**Roland Scandinavia A/S
SWEDISH SALES OFFICE**
Danvik Center 28, 2 tr.
S-131 30 Nacka SWEDEN
TEL: (0)8 702 00 20

SWITZERLAND

Roland (Switzerland) AG
Landstrasse 5, Postfach,
CH-4452 Ittingen,
SWITZERLAND
TEL: (061) 927-8383

UKRAINE

TIC-TAC
Mira Str. 19/108
P.O. Box 180
295400 Munkachevo, UKRAINE
TEL: (03131) 414-40

UNITED KINGDOM

Roland (U.K.) Ltd.
Atlantic Close, Swansea
Enterprise Park, SWANSEA
SA7 9FI,
UNITED KINGDOM
TEL: (01792) 702701

MIDDLE EAST

BAHRAIN

Moon Stores
No.16, Bab Al Bahrain Avenue,
P.O.Box 247, Manama 304,
State of BAHRAIN
TEL: 211 005

CYPRUS

Radex Sound Equipment Ltd.
17, Diagorou Street, Nicosia,
CYPRUS
TEL: (022) 66-9426

IRAN

MOCO, INC.
No.41 Nike St., Dr.Shariyati Ave.,
Roberoye Cerah Mirdamad
Tehran, IRAN
TEL: (021) 285-4169

ISRAEL

**Halilit P. Greenspoon &
Sons Ltd.**
8 Retzif Ha'aliya Hashnya St.
Tel-Aviv-Yafo ISRAEL
TEL: (03) 6823666

JORDAN

AMMAN Trading Agency
245 Prince Mohammad St.,
Amman 1118, JORDAN
TEL: (06) 464-1200

KUWAIT

Easa Husain Al Yousifi Est.
Abdullah Salem Street,
Safat, KUWAIT
TEL: 243-6399

LEBANON

Chahine S.A.L.
Gerge Zeidan St., Chahine Bldg.,
Achrafieh, P.O.Box: 16-5857
Beirut, LEBANON
TEL: (01) 20-1441

QATAR

**Al Emadi Co. (Badie Studio
& Stores)**
P.O. Box 62,
Doha, QATAR
TEL: 4423-554

SAUDI ARABIA

**aDawlah Universal
Electronics APL**
Corniche Road, Aldossary Bldg.,
1st Floor, Alkhobar,
SAUDI ARABIA

P.O.Box 2154, Alkhobar 31952
SAUDI ARABIA
TEL: (03) 898 2081

SYRIA

**Technical Light & Sound
Center**
Khaled Ebn Al Walid St.
Bldg. No. 47, P.O.Box 13520,
Damascus, SYRIA
TEL: (011) 223-5384

TURKEY

**Barkat muzik aletleri ithalat
ve ihracat Ltd Sti**
Siraselviler Caddesi Siraselviler
Pasaji No:74/20
Taksim - Istanbul, TURKEY
TEL: (0212) 2499324

U.A.E.

**Zak Electronics & Musical
Instruments Co. L.L.C.**
Zabeel Road, Al Sherooq Bldg.,
No. 14, Grand Floor, Dubai, U.A.E.
TEL: (04) 3360715

NORTH AMERICA

CANADA

**Roland Canada Music Ltd.
(Head Office)**
5480 Parkwood Way Richmond
B. C., V6V 2M4 CANADA
TEL: (604) 270 6626

Roland Canada Music Ltd.

(Toronto Office)
170 Admiral Boulevard
Mississauga On L5T 2N6
CANADA
TEL: (905) 362 9707

U. S. A.

Roland Corporation U.S.
5100 S. Eastern Avenue
Los Angeles, CA 90040-2938,
U. S. A.
TEL: (323) 890 3700

As of April 1, 2003 (Roland)



This product complies with the requirements of European Directives EMC 89/336/EEC and LVD 73/23/EEC.

For EU Countries

FEDERAL COMMUNICATIONS COMMISSION RADIO FREQUENCY INTERFERENCE STATEMENT

This equipment has been tested and found to comply with the limits for a Class B digital device, pursuant to Part 15 of the FCC Rules. These limits are designed to provide reasonable protection against harmful interference in a residential installation. This equipment generates, uses, and can radiate radio frequency energy and, if not installed and used in accordance with the instructions, may cause harmful interference to radio communications. However, there is no guarantee that interference will not occur in a particular installation. If this equipment does cause harmful interference to radio or television reception, which can be determined by turning the equipment off and on, the user is encouraged to try to correct the interference by one or more of the following measures:

- Reorient or relocate the receiving antenna.
- Increase the separation between the equipment and receiver.
- Connect the equipment into an outlet on a circuit different from that to which the receiver is connected.
- Consult the dealer or an experienced radio/TV technician for help.

This device complies with Part 15 of the FCC Rules. Operation is subject to the following two conditions:

- (1) This device may not cause harmful interference, and
- (2) This device must accept any interference received, including interference that may cause undesired operation.

Unauthorized changes or modification to this system can void the users authority to operate this equipment.
This equipment requires shielded interface cables in order to meet FCC class B Limit.

For the USA

NOTICE

This Class B digital apparatus meets all requirements of the Canadian Interference-Causing Equipment Regulations.

AVIS

Cet appareil numérique de la classe B respecte toutes les exigences du Règlement sur le matériel brouilleur du Canada.

For Canada

