

KENWOOD

STEREO POWER AMPLIFIER

KAC-1021

INSTRUCTION MANUAL

KENWOOD CORPORATION

Take the time to read through this instruction manual. Familiarity with installation and operation procedures will help you obtain the best performance from your new power amplifier.

For your records

Record the serial number found on the bottom of the unit in the spaces designated on the warranty card and in the space provided below. Refer to the model and serial numbers whenever you call upon your KENWOOD dealer for information or service on this product.

Model KAC-1021 Serial number _____

WARNING

TO PREVENT ELECTRIC SHOCK,
FIRE AND OTHER INJURY.
PLEASE NOTE THE FOLLOWINGS:

- To keep good ventilation, do not anything on top of the unit.

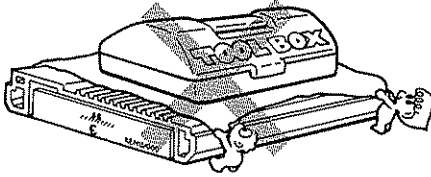

- Do not drop pieces of metal, needles, coins and other electrically conductive materials into the unit.

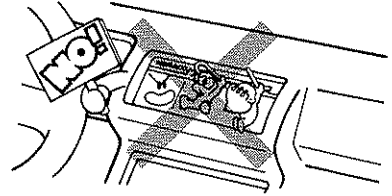

- The unit is designed to be connected 12 V DC and negative grounding.

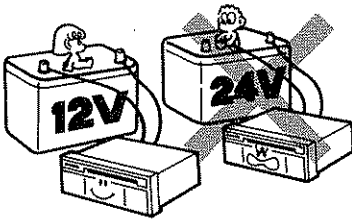

- Do not place the unit, where it will be exposed to direct sunlight or close to heating device.

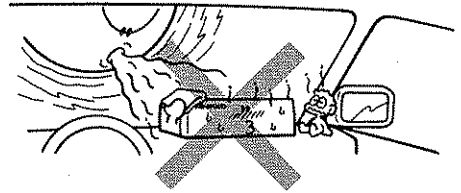

- Do not open enclosure, such as front panel, top or bottom cover.

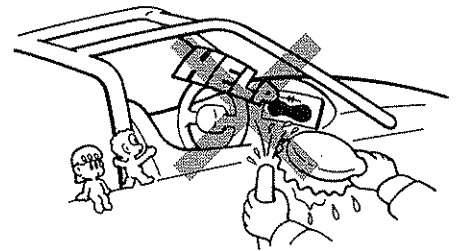
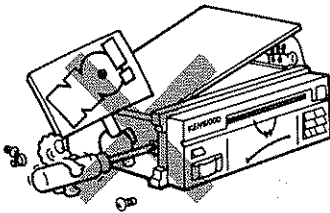

- Do not dash water on the unit.

- Do not place the unit in areas of excessive dust, high humidity or on unstable surfaces.

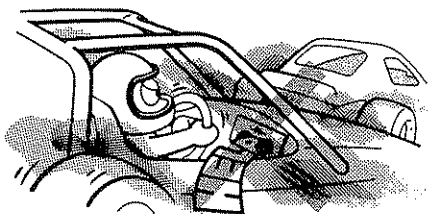

- KAC-1021 is designed to be **professionally installed**. The length and nature of your warranty are dramatically affected if you attempt to install it yourself. Skill and experience are required to achieve high-end sound, reliability, and appearance in a high-powered autosound system. If you want to install your own unit, read this booklet completely, research speaker systems and source units extensively.
- Under normal operation, the amplifier may become too hot to touch. Please use caution.
- When removing the amplifier, disconnect the fusible link at the battery prior to disconnecting the amplifier.

CLEANING

1. Turn the power off, before cleaning the unit.
2. Do not use any type of abrasive pad, thinner, benzine and any such kind of objects.
3. Wipe the front panel and other exterior surfaces of the unit with a soft dry cloth or a soft cloth lightly moistened with a neutral detergent.

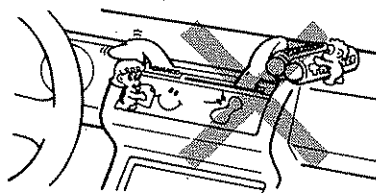

- If an abnormal smell or smoke is detected, immediately turn the power off.

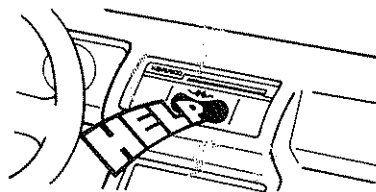

- If you have difficulty in installing the set in your car, please contact your KENWOOD dealer.

CAUTION

Battery and charging system

KAC-1021 amplifier draws enough current to put a substantial additional demand on automotive electrical systems. When played very loudly, the KAC-1021 may draw 20 to 40 Amperes on the average, with peak demands up to 120 Amperes!

A typical stock battery and alternator in good condition will handle moderate to low average levels, with occasional brief episodes of hard use. However, alternator and battery life will be shortened. We strongly recommend that a premium deep-cycle battery and heavy-duty alternator be used with KAC-1021 systems.

If the sound system will be used when the car is not running, the battery will obviously be discharged — perhaps enough to prevent restarting. The discharge/recharge cycle will reduce battery life, and alternator life will be shorter because of the high-current recharge requirements.

If problems arise:

- a) Use a premium battery or deep-discharge marine battery.
- b) Use a heavy duty alternator.
- c) Use a trickle-charger or battery charger.
- d) Install a second battery for the amp, with a switching system for recharge.

ACCESSORY

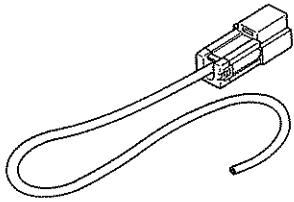
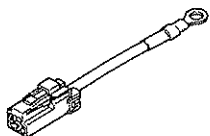
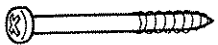
| No. | Part name | External View | Number of units |
|-----|---------------------------------------|---|-----------------|
| ① | Power supply cord (Yellow) |  | 1 |
| ② | Fusible link |  | 1 |
| ③ | Tapping screws ($\phi 5 \times 50$) |  | 4 |

CONNECTIONS

■ Before making connections

- Before installing the amplifier, be sure to disconnect the wire from the battery's negative (-) terminal to prevent hazards caused by short-circuiting.
- When the amplifier installation and wiring have been completed, first check that they are correct, then set the volume control to the minimum position to prevent speaker damage due to high volume when power is supplied. After this, re-connect the battery's negative (-) terminal which was disconnected previously.

■ Caution on fuse

When the fuse is blown, first check that the cables are not short-circuited, then replace it with a 15 A x 4 (60 A) fuse. (Use a 30 A x 4 fuse when measuring the maximum power output.)

■ Caution on speakers

This unit is an amplifier featuring a large power output of 420 W + 420 W (840 W in the case of a bridged output) (when speakers with an impedance of 4 ohms are used). Therefore, the speakers to be used should have a high maximum input capacity. If you have to use speakers with a small maximum input rating, regulate the volume with careful consideration to prevent speaker damage. The speakers must have an impedance of more than 4 ohms.

■ Caution on RCA pin-plug cords

- When an audio system from manufacturers other than KENWOOD is connected to the RCA pin jacks of this unit, adjust the input sensitivity adjustment potentiometer of this unit according to the output level of the system.
- Because the RCA pin-plug cord is more sensitive to external noise than the DIN cable, use consideration when placing the cord.

■ Operations according to system

• **Mode switch**
This switch is used to set the unit's output system to Normal or Bridged, as described below.

NORMAL BRIDGED



Normal (Stereo) output Bridged (Monaural) output (See below)

KAC-1021



• **Sub woofer system**
By setting the switch on the left to ON, you can set the output of this unit for sub woofer output (monaural output). The control on the right can be used to adjust the sub woofer cut-off frequency.

SUB WOOFER

OFF ON

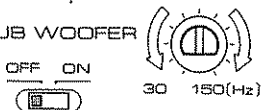

30 150 (Hz)

OFF ↔ ON

■ This unit is provided with a bridged output function which enables you to double the unit's power output. Since the output becomes monaural when the bridged output function is used, systems can be configured such as those shown below. (for 4 Ω speakers)

- When using a KENWOOD DIN output system:

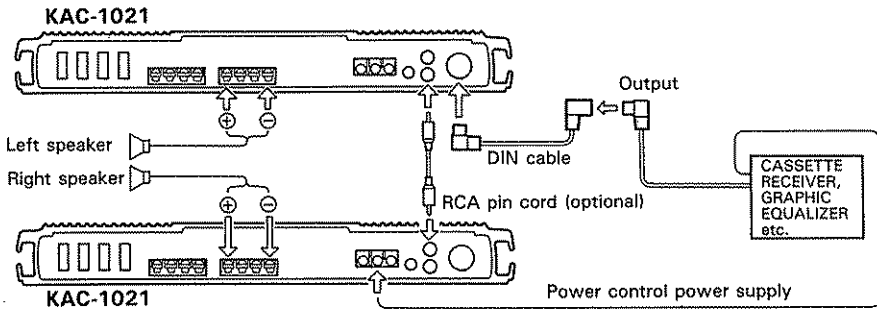

- When using an RCA pin-plug cord output system:

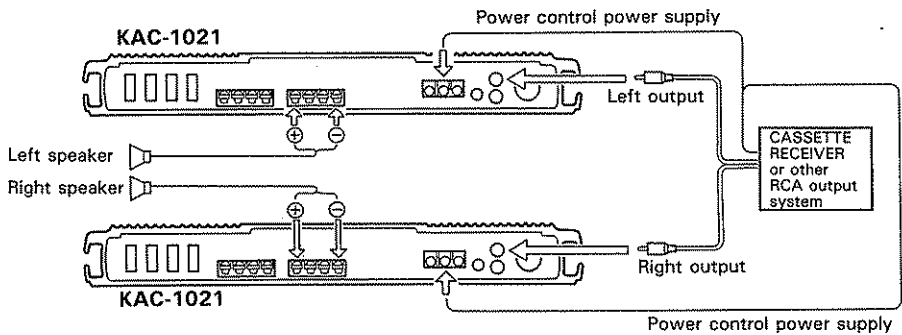

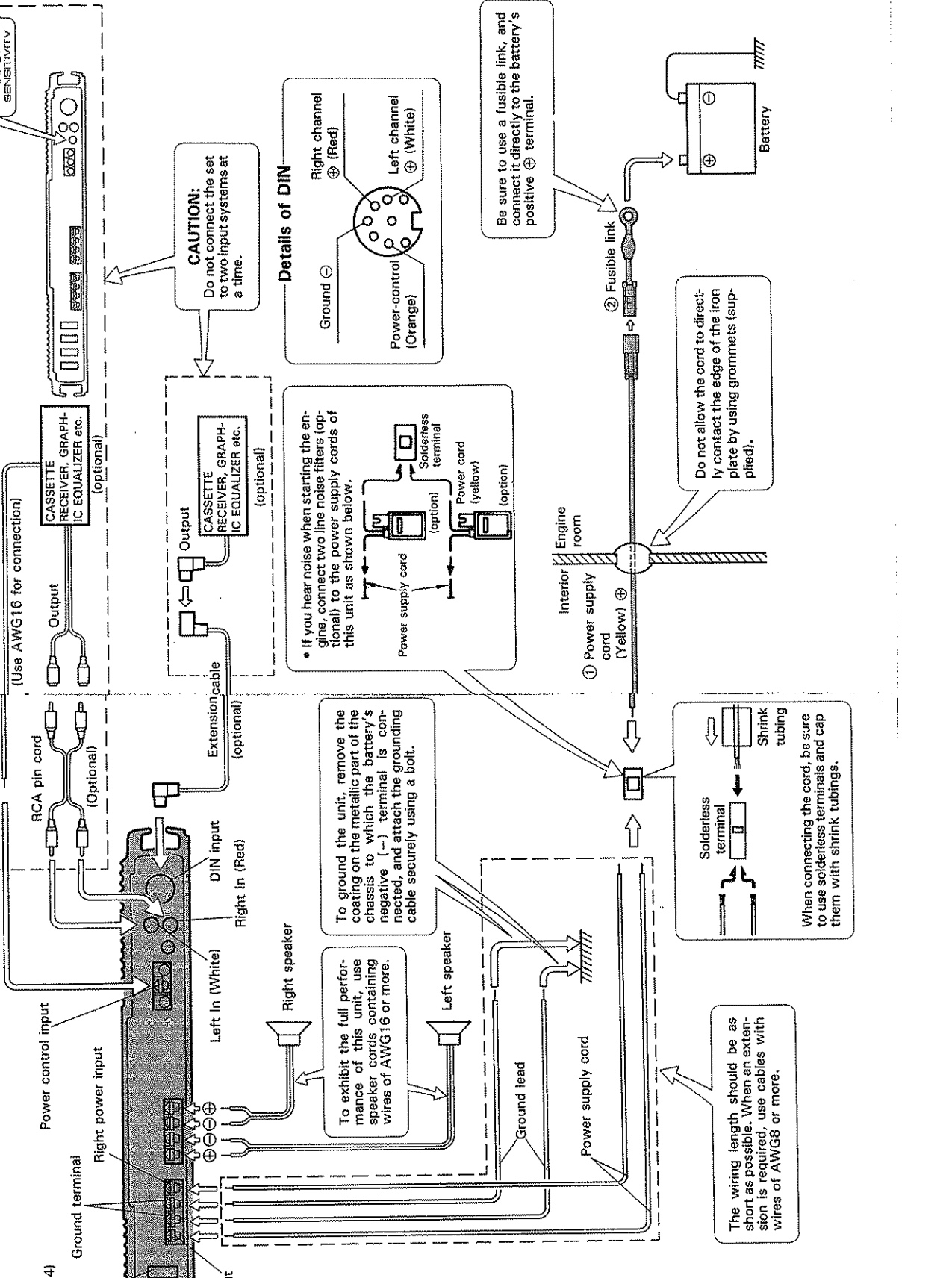

INSTALLATION

1. Installation

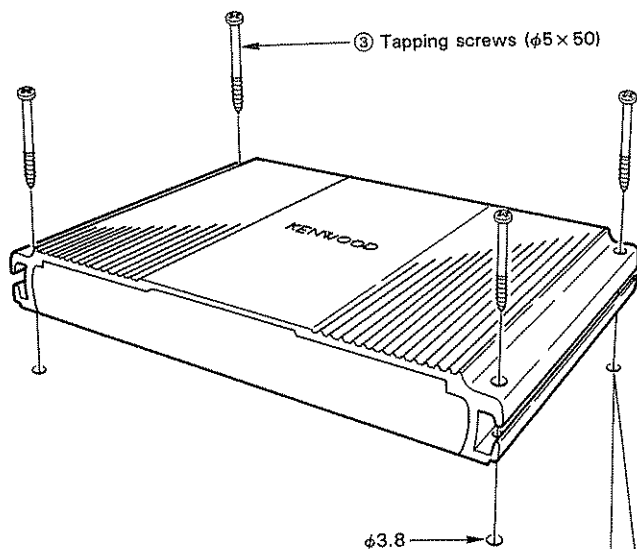

CAUTION
When making the hole,
do not damage the fuel
tank, brake tube, wiring
harnesses, etc. on the
other side.



- When installing to the car, install the unit securely for safety driving.
- Use screws supplied as accessories when installing the unit.
- Install the unit in a well-ventilated place and do not place the (heavy) object on it.

2. Installation location

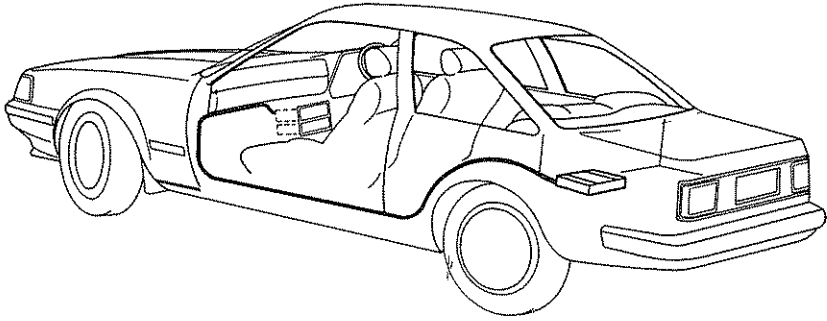

- Since the power amplifier has no parts which require operation, it can be installed at a position away from the driver's seat without any hinderances. As generally accepted positions for its installation, places such as inside the trunk, etc. can be considered.
- Use the extension cables. CA-8L (0.5 m), CA-18L (1 m), CA-28L (2 m), CA-48L (4 m), and CA-68L (6 m) (optional) when the connected models are to be installed away from the power amplifier.

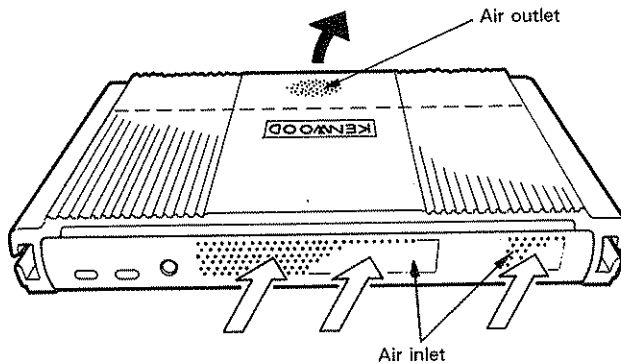

- This unit incorporates a cooler fan, which starts rotation automatically when the temperature rises during use. Take care not to block the air inlet and outlet for this fan.

TROUBLESHOOTING GUIDE

What often appears to be a malfunction is often due to user error in operation or connection. When trouble occurs with your unit, please check the following before calling for service.

| Symptom | Cause | Remedy |
|---|--|--|
| The sound level is low. (No sound from one side.) | A speaker cord has become unconnected. | Check the speaker cord connections. |
| The sound quality is bad. (The sound is distorted.) | 1. The speakers are connected to the same wires. 2. A speaker cord is pinched by a screw in the car body. | 1. Connect each speaker terminal to its respective speaker output. 2. Check the speaker wiring. |

SPECIFICATIONS

Specifications subject to change without notice.

Audio section

Max Power Output (1 kHz, 4 Ω)

Normal 420 W + 420 W

Bridged 840 W

Power Output

Normal (20 Hz ~ 20 kHz, 4 Ω , less than 0.08% THD) 220 W + 220 W

Bridged (1 kHz, 4 Ω , 0.08% THD) 440 W

Output Power

Normal (1 kHz, 2 Ω , 0.08% THD) 370 W + 370 W

Frequency Response (-3 dB) 2 Hz ~ 100 kHz

Sensitivity (rated output) MAX. 0.1 V

MIN. 5.0 V

Signal to Noise Ratio 105 dB

Input Impedance 10 k Ω

Damping Factor (100 Hz) More than 5000

Sub Woofer Frequency 30 ~ 150 Hz (variable)

General

Operating Voltage 14.4 V (11 ~ 16 V allowable)

Current Consumption (MAX.) 60 A

Dimensions (W x H x D) 400 x 55 x 300 mm

(15-3/4 x 2-3/16 x 11-13/16 in.)

Weight 6.9 kg (15.2 lb)