

# USER'S GUIDE

## TABLE OF CONTENTS

Welcome .....	1
Safety Instructions .....	2-3
Controls at a Glance .....	4-7
Function Pads .....	4-5
Setting the Clock .....	5
Setting the Timer .....	5
Control Options .....	5-6
Lower Oven Controls (select models) .....	7
Oven Light & Vent .....	7
Oven Operation .....	8-11
Oven Fans .....	8
Baking, Roasting and Convection Cooking .....	8
Oven Racks and Positions .....	9
Broiling .....	10
Clock Controlled Oven Operations .....	11
Care and Cleaning .....	12-15
Self-Clean Oven .....	12-13
Cleaning Chart .....	14-15
Maintenance .....	15
Before You Call for Service .....	16-17
If You Need Service .....	18
Warranty .....	19

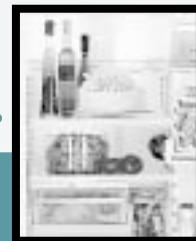

**Models: MEW5527, MEW6527, MEW5627, MEW5530B,  
MEW6530B, MEW5630, MMW5527, MMW5530**

# Welcome.....

Congratulations on your choice of a Maytag electric wall oven. Your complete satisfaction is very important to us.

**Read this user's guide carefully.** It is intended to help you operate and maintain your new wall oven.

In addition, you will find a booklet entitled "**Cooking Made Simple.**" It contains information on selecting bakeware and provides baking, roasting and broiling tips.

**Save time and money.** Check the "Before You Call" section of this guide. It lists causes of minor operating problems that you can correct yourself.

However, should you need service, it is helpful to have the model and serial numbers available. This information can be found on the data plate located on the oven front frame.

These numbers are also on the Product Registration card that came with your appliance. Before sending in this card, record these numbers along with the purchase date below.

Model Number -----
Serial Number -----
Date of Purchase _____

**IMPORTANT: Keep this guide and the sales receipt in a safe place for future reference. Proof of original purchase date is needed for warranty service.**

If you have questions, write us (include your model number and phone number) or call:

Maytag Appliances Sales Company

Attn: CAIR® Center

P.O. Box 2370

Cleveland, TN 37320-2370

1-800-688-9900 (USA)

1-800-688-2002 (CANADA)

1-800-688-2080 ( U.S. TTY for deaf, hearing impaired or speech impaired)

(Mon. - Fri., 8 am-8 pm Eastern Time)

Internet: <http://www.maytag.com>

**For service information, see page 18.**

## Note:

- *In our continuing effort to improve the quality and performance of our cooking products, it may be necessary to make changes to the appliance without revising this guide.*
- *For Microwave Oven operation (select models), refer to the use and care guide packed in the microwave oven.*

# IMPORTANT SAFETY INSTRUCTIONS .....

The following instructions are based on safety considerations and must be strictly followed to eliminate the potential risks of fire, electric shock, or personal injury.

## **Installation and Repair**

- Have your appliance installed and properly grounded by a qualified installer according to the installation instructions.
- To ensure proper operation and avoid possible injury or damage to unit do not attempt to adjust repair, service, or replace any part of your appliance unless it is specifically recommended in this book. All of the servicing should be referred to a qualified installer or servicer.

## **To Prevent Fire or Smoke Damage**

- Be sure all packing materials are removed from the appliance before operating it.
- Keep area around appliance clear and free from combustible materials. Flammable materials should not be stored in an oven.
- Many plastics are vulnerable to heat. Keep plastics away from parts of the appliance that may become warm or hot.
- To prevent grease fires, do not let cooking grease or other flammable materials accumulate in or near the appliance.
- Do not use the oven as a storage area for food or cooking utensils.
- Many aerosol-type spray cans are **EXPLOSIVE** when exposed to heat and may be flammable. Avoid their use or storage near the oven.

## **In Case of Fire**

- Use dry chemical or foam-type extinguisher or baking soda to smother fire or flame. Never use water on a grease fire.
  1. Turn off appliance to avoid spreading the flame.
  2. **NEVER** pick up or move a flaming pan.
  3. Smother fire or flame by closing the oven door.

## **Child Safety**

- **NEVER** leave children alone or unsupervised near the appliance when it is in use or is still hot. Children should never be allowed to sit or stand on any part of the appliance as they could be injured or burned.

- Children must be taught that the appliance and utensils in it can be hot. Let hot utensils cool in a safe place, out of reach of small children. Children should be taught that an appliance is not a toy. Children should not be allowed to play with controls or other parts of the unit.
- **CAUTION: NEVER** store items of interest to children in cabinets above an appliance. Children climbing on the appliance or on the appliance door to reach items could be seriously injured.

## **About Your Appliance**

- To prevent potential hazard to the user and damage to the appliance, never use appliance to heat or warm a room.
- Do not obstruct the flow of air by blocking the oven vent.
- **DO NOT TOUCH HEATING ELEMENTS OR INTERIOR SURFACES OF OVEN.** Heating elements may be hot even though they are dark in color. Interior surfaces of any oven become hot enough to cause burns. During and after use, do not touch, or let clothing or other flammable materials contact heating elements or interior surfaces of oven until they have had sufficient time to cool. Other surfaces of the appliance may become hot enough to cause burns – among these surfaces are: oven vent openings and surfaces near these openings, oven doors, windows of oven doors.
- **CAUTION: NEVER** use an appliance as a step to reach cabinets above. Misuse of appliance doors, such as stepping, leaning or sitting on the door, may result in possible tipping of the appliance, breakage of door, and serious injuries.
- Do not touch a hot oven light bulb with a damp cloth as the bulb could break. Should the bulb break, disconnect power to the appliance before removing bulb to avoid electrical shock.
- A fan should be heard during some bake, convection bake, and all broil and cleaning operations. If you do not hear the fan, call an authorized servicer.
- **NEVER** use aluminum foil to cover an oven rack or oven bottom. Misuse could result in risk of electric shock, fire, or damage to the appliance. Use foil only as directed in this guide. Do not allow aluminum foil to contact heating element.



# IMPORTANT SAFETY INSTRUCTIONS (continued) . . . . .

## Cooking Safety

- **NEVER** heat an unopened food container in the oven. Pressure build-up may cause container to burst resulting in serious personal injury or damage to the appliance.
- Use dry, sturdy potholders. Damp potholders may cause burns from steam. Dish towels or other substitutes should never be used as potholders because they can trail across hot elements and ignite or get caught on appliance parts.
- **NEVER** wear loose fitting or long hanging-sleeved apparel while cooking. Clothing may ignite and cause burns if garment comes in contact with heating elements.
- Always place oven racks in the desired positions while oven is cool. If a rack must be moved while hot, use a dry potholder. Do not let potholder contact hot element in oven.
- Use care when opening the oven door. Let hot air or steam escape before removing or replacing food.
- **PREPARED FOOD WARNING:** Follow food manufacturer's instructions. If a plastic frozen food container and/or its cover distorts, warps, or is otherwise damaged during cooking, immediately discard the food and its container. The food could be contaminated.
- Always turn off all controls when cooking is completed.

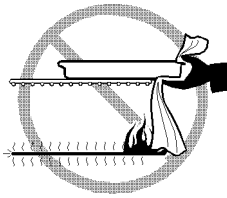

## Utensil Safety

- Follow the manufacturer's directions when using oven cooking bags.
- This appliance has been tested for safe performance using conventional cookware. Do not use any devices or accessories that are not specifically recommended in this manual. Do not use add-on oven convection systems. The use of devices or accessories that are not expressly recommended in this guide can create serious safety hazards, result in performance problems, and reduce the life of the components of the appliance.
- Only certain types of glass, glass/ceramic, ceramic, earthenware, or other glazed utensils are suitable for oven service without breaking due to the sudden change in temperature. Follow utensil manufacturer's instructions when using glass.

## Cleaning Safety

- Turn off all controls and wait for appliance parts to cool before touching or cleaning. Clean with caution. Use care to avoid steam burns if a wet sponge or cloth is used to wipe spills on a hot surface. Some cleaners can produce noxious fumes if applied to a hot surface.
- Clean only parts listed in this guide.

## Self-Clean Oven

- Do not clean door gasket. The door gasket is essential for a good seal. Care should be taken not to rub, damage, or move the gasket.
- Do not use oven cleaners or oven liners of any kind in or around any part of the self-clean oven.
- Before self-cleaning the oven, remove broiler pan, oven racks and other utensils, and wipe off excessive spillovers to prevent excessive smoke or flare ups.
- **CAUTION: NEVER** leave food or cooking utensils, etc. in the oven during the self-clean cycle.

## Important Safety Notice and Warning

The California Safe Drinking Water and Toxic Enforcement Act of 1986 (Proposition 65) requires the Governor of California to publish a list of substances known to the State of California to cause cancer or reproductive harm, and requires businesses to warn customers of potential exposures to such substances.

Users of this appliance are hereby warned that when the oven is engaged in the self-clean cycle, there may be some low-level exposure to some of the listed substances, including carbon monoxide. Exposure to these substances can be minimized by properly venting the oven to the outdoors by opening the windows and/or door in the room where the appliance is located during the self-clean cycle.

**IMPORTANT NOTICE REGARDING PET BIRDS:** Never keep pet birds in the kitchen or in rooms where the fumes from the kitchen could reach. Birds have a very sensitive respiratory system. Fumes released during an oven self-cleaning cycle may be harmful or fatal to birds. Fumes released due to overheated cooking oil, fat, margarine and overheated non-stick cookware may be equally harmful.

Save These Instructions for Future Reference

# Controls at a Glance

The control panel is designed for ease in programming. The display window on the electronic control shows time of day, timer and oven functions. Indicator words flash to prompt your programming steps.



**NOTE:** Styling and features may differ slightly depending on the model. Control panel shown above includes Convection Bake feature.

## Function Pads

- Press the desired pad.
- Press, or press and hold, these pads to enter time, oven temperature or to select HI or LO broil.
- Press the **CANCEL** pad to cancel all operations except the **TIMER** and **CLOCK**.



**NOTE:** If more than 30 seconds elapse between pressing a function pad and a or pad, the program will be canceled and the display will return to the time of day.

### CONVECT Pad (select models)

Use for convection baking or roasting.

1. Press **CONVECT** pad.
2. Press or pad once and 325° will appear in the display. Continue pressing until the desired oven temperature appears in the display.

See page 8 for additional information.

### BAKE Pad

Use for baking or roasting.

1. Press **BAKE** pad.
2. Press or pad once and 350° will appear in the display. Continue pressing until the desired oven temperature appears in the display.

See page 8 for additional information.

### BROIL Pad

Use for top browning and broiling.

1. Press **BROIL** pad.
2. Press or pad for HI or LO broil.

See page 10 for additional information.

### CLEAN Pad

Use to set self-clean cycle.

1. Press **CLEAN** pad. “-- : --” will appear in the display.
2. Press or pad. “3:00” hours of cleaning time will automatically be entered.
3. If more or less cleaning time is desired, press or pad to select times between 2 to 4 hours.

See pages 12-13 for additional information.

### COOK TIME/STOP TIME Pads

Use to program the oven to start and stop automatically.

1. Press **COOK TIME** pad and enter the desired cooking time.
2. Press the **BAKE** or **CONVECT** (select models) pad and enter oven temperature.
3. To delay the start of cooking, press the **STOP TIME** pad and enter the time you wish the oven to turn off.

See page 11 for additional information.

# Controls at a Glance (continued) .....

## CONTROL LOCK Pad

The control touch pads can be locked to prevent unwanted use. They will not function when locked.

If an oven function is currently being used, the controls cannot be locked.



The current time of day will remain in the display when this feature is activated.

### Setting Control Lock:

1. Press and hold the **CONTROL LOCK** pad for several seconds. The control will beep once indicating it is locked.
  - OFF will appear in the display for 15 seconds if any pad is pressed.

**To Cancel:** Press and hold the **CONTROL LOCK** pad for several seconds. The indicator word OFF will disappear in the display.

## Setting the CLOCK

1. Press **CLOCK** pad.
2. Press or press and hold  or  pad until the correct time of day appears in the display.

The display will flash when electrical power is first supplied to the oven or if there has been a power failure.



To recall the time of day when another function is displayed, press the **CLOCK** pad.

Clock time cannot be changed when the oven has been programmed for clock controlled cooking, self-clean or delayed self-clean.

## Setting the TIMER

The timer can be set from one minute (0HR:01) up to 99 hours and 59 minutes (99:59).

The timer can be used independently of any other oven activity and it can be set while another oven function is operating. **THE TIMER DOES NOT CONTROL THE OVEN.**

1. Press the **TIMER** pad.
  - The indicator word **TIMER** will flash.
2. Press or press and hold the  or  pad until the correct time appears in the display.

Example of timer set for five minutes:

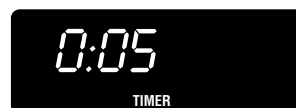

- The timer will start automatically after four seconds. A flashing colon indicates that the timer is in use during another function's operation.
  - The last minute of the countdown will be displayed as seconds.
3. At the end of the time set, one long beep will sound. (To change the number of timer reminder beeps, see below.)

**To cancel:** Press and hold the **TIMER** pad for several seconds. The time of day will reappear in the display.



## Control Options

### Timer Beep Option

You have a choice of three “end of timer” reminder signals.

- Option 1.** One beep at the end of the timer operation, then, one beep every 30 seconds for the next five minutes or until the **CANCEL** pad is pressed.
- Option 2.** One beep at the end of the timer operation, then, one beep every minute for the next 12 hours or until the **CANCEL** pad is pressed.
- Option 3. (default option)** One beep at the end of the timer operation, then, no other beeps.

### Setting the Timer Beeps

1. Press the **TIMER** and **CANCEL** pads at the same time and hold for several seconds.
  - A single beep will sound.
  - Display will show current option - 1, 2 or 3.
2. Press the  or  pad to select the option number you wish. The current time of day will reappear in the display after four seconds.

## ***Clock Controlled Oven Cooking Beep Option***

**You have a choice of three “end of timed cook” reminder signals for programmed cooking.**

**Option 1. (default option)** Four beeps at the end of cooking, then, one beep every 30 seconds for the next five minutes or until the **CANCEL** pad is pressed.

**Option 2.** Four beeps at the end of cooking, then, one beep every minute for the next 12 hours or until the **CANCEL** pad is pressed.

**Option 3.** Four beeps at the end of cooking, then, no other beeps.

### **Setting Clock Controlled Oven Cooking Beeps**

1. Press **COOK TIME** and **CANCEL** pads at the same time and hold for several seconds.
  - A single beep will sound.
  - Display will show current option - 1, 2 or 3.
2. Press the  or  pad to select the option number you wish. The current time of day will reappear in the display after four seconds.

## ***Cancel Clock Display Option***

**If you prefer that the time of day not be displayed when the oven is not operating:**

**To set:** Press **CLOCK** and **CANCEL** pads at the same time and hold for several seconds. The time of day will disappear in the display.

When clock display is not shown, press **CLOCK** pad to briefly recall the time of day, if desired.

**To restore:** Press the **CLOCK** and **CANCEL** pads at the same time and hold for several seconds. The time of day will reappear in the display.

**NOTE:** Clock display is always displayed during any cooking operation.

## ***Automatic Oven Turn Off Option***

The oven will automatically turn off after 12 hours, if you accidentally leave it on. You can deactivate this feature, if desired.

### **To Eliminate 12 Hour Turn Off**

1. Press the **CLOCK** pad and hold for several seconds.
2. Press and hold the  or  pad until 8888 appears in the display. Current time of day will reappear in the display after four seconds.

**To restore:** Repeat steps 1 and 2. “12” will appear briefly in the display followed by the current time of day.

## ***Oven Temperature Adjustment Option***

You may adjust the oven temperature if you think the oven is not baking correctly. To decide how much to change the temperature, set the temperature 25 degrees higher or lower than your recipe recommends, then bake. The results of the “test” should give you an idea of how much to adjust the temperature.

### **To Adjust the Oven Temperature**

1. Press the **BAKE** pad.
2. Enter 550° by pressing  pad.
3. Press and hold the **BAKE** pad for several seconds until 0° appears in the display.
  - If the oven temperature was previously adjusted, the change will be displayed. For example, if the oven temperature was reduced by 15°, the display will show -15°.
4. Press and hold the  or  pad to change the temperature. Each time a pad is pressed, the temperature changes by 5°.
  - The oven temperature can be **increased or decreased** by 5 ° increments up to 35 °.
5. The time of day will automatically reappear in the display.

It is not necessary to readjust the oven temperature if there is a power failure or interruption. Broiling and cleaning temperatures cannot be adjusted.

# Controls at a Glance (continued) .....

## Lower Oven Controls (select models)

### Setting the Controls

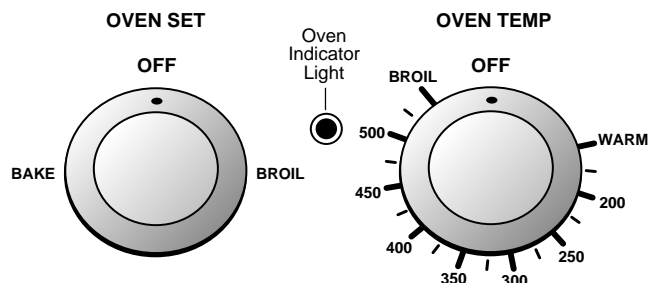

The **OVEN SET** knob determines the type of oven operation. Turn this knob to the desired setting. The oven will not operate if the **OVEN SET** knob is left in the OFF position.

The **OVEN TEMP** knob is used to set the oven temperature. Always turn this knob just to the desired temperature. Do not turn to a higher temperature and then back.

### Oven Indicator Light

The oven indicator light, located on the control panel between the Oven Set and Oven Temp knobs, turns on whenever the lower oven turns on.

When the oven reaches the preset temperature, the indicator light turns off. The oven indicator light will then turn off and on as the oven elements cycle off and on.

## Oven Light

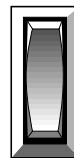

The oven light automatically comes on whenever the oven door is opened. Push the switch on the control panel to turn it on and off when the oven door is closed.

## Oven Vent

**When the oven is in use, the area near the oven vent may feel warm to the touch. Do not block the vent opening for best baking results.**

The oven vent is located below the control panel on your wall oven.





# Oven Operation

## Baking, Roasting and Convection Cooking

Every oven has its own characteristics. You may find that the cooking times and temperatures vary slightly from your old oven. This is normal.

### Oven Fans



A **cooling fan** will automatically turn on during cleaning, broiling and some baking operations. It is used to help keep internal parts on the control panel cool. The fan will automatically turn off when parts have cooled. The fan may continue to operate after the oven has been turned off. This is normal.

A **convection fan** (select models) is used to circulate hot air in the oven when the convection feature is selected. It automatically turns on whenever the **CONVECT** pad is pressed and will turn off when **CONVECT** is canceled.

**NOTE:** The convection fan will automatically stop whenever the oven door is opened.

### Setting the Controls for Baking, Roasting and Convection Cooking\*





\* Convection feature available on select models only.

1. Press **BAKE** or **CONVECT** pad.
  - **BAKE** or **CONVECT** will flash in display.
  - 000 will light in display.
  - When convection cooking is selected, a fan icon  will also appear.
2. Press or press and hold the  or  pad to select oven temperature.
  - 350° is set when either pad is pressed. When convection cooking, 325° is set.
  - Oven temperature can be set from 100° to 550°.
3. There will be a four second delay before oven turns on. When the oven turns on:
  - **PREHEAT** indicator will light in the display.
  - The **BAKE** symbol will light in display.
  - When convection cooking, the fan icon will begin to rotate.
  - 100° or the actual oven temperature will appear in the display.
  - The temperature will increase by 5° until the oven reaches the preselected temperature.

4. Allow 8-15 minutes for the oven to preheat.
  - A single beep will indicate that the oven has preheated.
  - The **PREHEAT** indicator will turn off.
5. Check cooking progress at the minimum cooking time. Cook longer if needed.
6. Press **CANCEL** pad and remove food from the oven.

**NOTE:** If you forget to turn off the oven, it will automatically turn off at the end of 12 hours. If you wish to deactivate this feature, see page 6.

### Notes . . .

- If more than 30 seconds elapse between pressing a function pad and pressing a  or  pad, the display will return to the previous display.
- To recall the set temperature during preheat, press the appropriate **BAKE** or **CONVECT** (select models) pad. The set temperature will be displayed briefly and then return to the on-going program.
- To change the oven temperature during cooking, press the appropriate **BAKE** or **CONVECT** (select models) and the appropriate  or  pads for the desired oven temperature.
- **As a general rule when convection baking, set the oven temperature 25°F lower than the conventional recipe or prepared mix directions.** Times will be similar to a few minutes less than directions.
- When convection is used to roast meats, roasting times are generally 25-30% less. (Maintain conventional roasting temperatures.)
- For additional baking, roasting and convection cooking tips plus a roasting chart with recommended roasting temperatures and times, see **“Cooking Made Simple”** booklet.



# Oven Operation (continued)

## Oven Racks

**Single convection ovens** are equipped with two flat and one offset rack.

**Single non-convection ovens** are equipped with one flat and one offset rack.

**Double ovens** are equipped with one flat and one offset rack for each oven.

**To remove:** Pull forward to the “stop” position; lift up on the front of the rack and pull out.

**To replace:** Place rack on the rack support in the oven; tilt the front end up slightly; slide rack back until it clears the lock-stop position; lower front and slide into the oven.

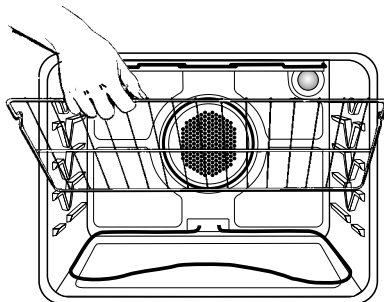

## Rack Positions

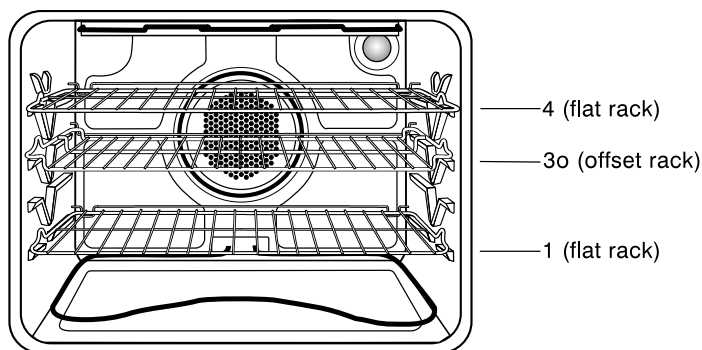

**Three rack convection cooking (select models).**

**Rack Position #4o** (offset rack on #4):

Most broiling.

**Rack Position #3:**

Some baked goods.

**Rack Position #3o** (offset rack on #3):

Most baked goods, pies, cakes and cookies.

**Rack Position #2:**

Roasting small cuts of meat, cakes in tube or bundt pans, casseroles.

**Rack Position #2o** (offset on #2):

Roasting, loaves of bread, angel food cake.

**Rack Position #1:**

Large cuts of meat and turkey, custard pie, dessert souffle.

## Multiple Rack Cooking:

**Two racks** (Convection or conventional cooking):

For cookies use #1 and #4o. For cakes use #2 and #4o.

**Three racks** (convection cooking only): Use #1, #3o, #4.

(See illustration at left.)

## Notes . . .

- The use of the offset rack is denoted in the list above as an “o” after the rack position number.
- Do not cover an entire rack with aluminum foil or place foil on the oven bottom. Baking results will be affected and damage may occur to the oven bottom.

## Broiling

For best results, use a pan designed for broiling. For additional broiling tips, see “*Cooking Made Simple*” booklet.

### Setting the Controls for Broiling

- Place the oven rack on the recommended rack position shown in the broiling chart.
- Press the **BROIL** pad.
  - BROIL will flash in the display.
  - 000 will light in the display.
- Press the  pad to select **HI** (high) broil or the  pad to set **LO** (low) broil.
  - Select HI broil for normal broiling.
  - Select LO broil for low temperature broiling of longer cooking foods such as poultry.
- There will be a four second delay before oven turns on. When oven turns on:
  - The BROIL symbol will light in display .
- For optimum browning, preheat broil element for 3-4 minutes before adding food.
- Place food in the oven. **Leave oven door opened to the broil stop position (about four inches).** Follow the suggested broiling times in the chart to the right.
- Turn meat once about half way through cooking.
- Press **CANCEL** pad. Remove food and broiler pan from the oven.

### Setting the Lower Oven Controls for Broiling (select models)

- Place the oven rack on the recommended rack position shown in the broiling chart.
- Turn **OVEN TEMP** knob to BROIL or, for lower temperature broiling, to 450°.
  - Lower temperature broiling is used to avoid excessive browning of longer cooking foods such as poultry.
- Turn **OVEN SET** knob to BROIL.
  - NOTE:** Oven will not operate if the **OVEN SET** knob is left in the OFF position.
- Preheat broil element for 3-4 minutes.
- Broil with the oven door open about four inches.

- Follow the suggested times in the broiling chart below. Meat should be turned once about halfway through its cooking time.
- After broiling, turn the **OVEN TEMP** and **OVEN SET** knobs to OFF.

Broiling Chart			
Chart time based on a preheated broil element using the “HI” setting			
Foods	Rack Position*	Minutes/Side (Approx.)	
		1st Side	2nd Side
<b>Beef</b>			
Steak (1"):			
Medium	4o	9	7
Well	4o	11	8
Hamburgers (3/4"):			
Medium	4o	5	3-4
Well	4o	6	4-5
<b>Pork</b>			
Chops (1/2")	4o	7	5-6
Chops (1")	3	10-11	9-10
Ham Slice	4o	4	2-3
<b>Poultry</b>			
Breast Halves (Bone-in)	3	11-12	9-11
<b>Seafood</b>			
Fish Steaks, Buttered (1")	4o	8-10	(no turning)

\*An "o" after the rack number implies that the offset rack should be used.

**Note:** This chart is a suggested guide. The times may vary with food being cooked.

### Notes . . .

- If more than 30 seconds elapse between pressing the **BROIL** pad and the  or  pad, the oven is not set and the display will return to the previous display.
- A cooling fan will automatically turn on during broiling. If it does not operate, contact an authorized servicer.**
- Expect broil times to increase and browning to be slightly lighter if appliance is installed on a 208 volt circuit.

# Oven Operation (continued)

## ⚠ CAUTION:

- Clock controlled cooking is not recommended for baked items that require a preheated oven, such as cakes, cookies, pies and breads.
- Highly perishable foods such as dairy foods, pork, poultry or seafood are not recommended for clock controlled cooking with a delayed start.

## Clock Controlled Oven Operations



The clock controlled oven cooking feature is used to turn the oven off at a preset time of day or delay the start and then turn off the oven.



The clock must be functioning and set at the correct time of day for this feature to operate correctly.

The feature can be used with either oven cooking or self-cleaning. See page 13 for instructions on delaying the start of a clean cycle.

## Setting the Controls

### To Start Immediately and Turn Off Automatically:



1. Press the **COOK TIME** pad.
  - 0:00 will light in display.
  - **COOK TIME** will flash in the display.
2. Press or press and hold  or  pad to enter cooking time.
3. Press **BAKE** or **CONVECT** pad.
  - 000 will light in display.
  - **BAKE** or **CONVECT** will flash in display.

*NOTE:* If **BAKE** or **CONVECT** pad is not selected in 4 seconds, beeps will sound.
4. Press or press and hold  or  pad to enter oven temperature.
5. When the oven turns on, the oven temperature and the **BAKE** symbol will light in display.
6. At the end of the programmed **COOK TIME**, the oven will turn off. Four beeps will sound and **END** will light in the display. A beep will sound every 30 seconds for the next 5 minutes.

7. Press **CANCEL** pad. Beeps will stop and time of day will reappear in display. Remove food from oven.

*NOTE:* See page 6 if you wish to change the end of cooking reminder beeps.

### To Delay the Start and Turn Off Automatically:

- 1 - 4. Follow preceding steps 1 - 4.
5. Press **STOP TIME** pad.
  - **STOP TIME** will flash in display.
  - a. Press or press and hold  or  pad to enter time of day you wish the oven to turn off.
  - b. Press **CLOCK** pad.
    - Time of day will reappear in the display.
  - c. **DELAY BAKE** will remain in display to show the oven is set for a delayed cook operation.

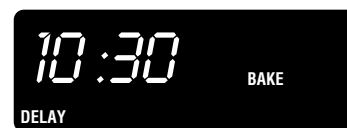
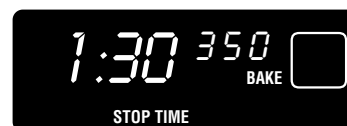

6. At the end of the delayed period, the **DELAY** indicator word will go off and the oven will begin to heat.
  7. At the end of the programmed **COOK TIME**, the oven will turn off. Four beeps will sound and **END** will light in the display. A beep will sound every 30 seconds for the next 5 minutes.
  8. Press **CANCEL** pad. Beeps will stop and time of day will reappear in display. Remove food from oven.
- NOTE:* See page 6 if you wish to change the end of cooking reminder beeps.

## Notes . . .

- If more than 30 seconds elapse between pressing the **BAKE** pad and setting a temperature, the display will return to the time of day.
- It is not necessary to set a start time. Control will determine when to turn the oven on based on the cook time you set.



# Care and Cleaning

## Self-Clean Oven

### CAUTION:

- It is normal for parts of the wall oven to become hot during a clean cycle. Therefore, during a clean cycle, avoid touching the oven vent area, oven door and window.

The self-clean cycle uses above normal cooking temperatures to automatically clean the entire oven interior.

It is normal for flare-ups, smoking or flaming to occur during cleaning if the oven is heavily soiled. It is better to clean the oven regularly rather than to wait until there is a heavy build-up of soil in the oven.

During the cleaning process, the kitchen should be well ventilated to help eliminate normal odors associated with cleaning.

**Do not use commercial oven cleaners** on the self-clean oven finish or around any part of the oven as they will damage the finish or parts.

### Before Self-Cleaning

Turn off the oven light before cleaning as the light may burn out during the clean cycle.

Remove broiler pan, all pans and the oven racks from the oven. **The oven racks will discolor and may not slide easily after a self-clean cycle.**

Clean oven frame, door frame (area outside the door gasket) and around the opening in the door gasket with a nonabrasive cleaning agent such as Bon Ami or detergent and water. These areas are not exposed to cleaning temperatures and should be cleaned to prevent soil from baking on during the clean cycle.

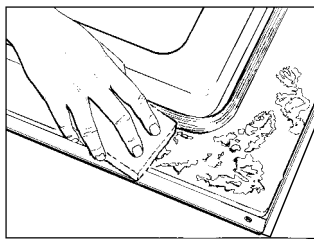



**To prevent damage, do not clean or rub the gasket around the oven door.** The gasket is designed to seal in heat during the clean cycle.

Wipe up excess grease or spillovers from the oven bottom to prevent excessive smoking, flare-ups or flaming during the clean cycle. For ease of cleaning, the heating element can be lifted slightly (1 to 1½ inches).

Wipe up sugary and acid spillovers such as sweet potatoes, tomato or milk-based sauces. Porcelain enamel is acid resistant, not acid proof. **The porcelain finish may discolor if acid spills are not wiped up prior to a self-clean cycle.**

### Setting the Controls for Self-Clean

1. Close oven door.
2. Press **CLEAN** pad.
  - “- - : - -” will light in the display.
  - **CLEAN** will flash in the display. **LOCK** indicator word will appear.
  - Door cannot be opened when **LOCK** is displayed.
  - If door is not closed or locked, beeps will sound and “door” will flash in the display.
3. Press  or  pad to select clean time or change clean time.
  - Oven is preset to clean for 3 hours. Or,
  - Select 2 hours for light soil up to 4 hours for heavy soil.
4. When the oven turns on the clean symbol will light in the display.

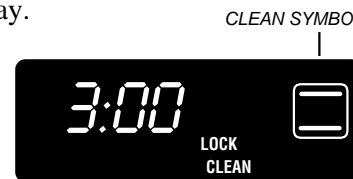

5. About one hour after the clean cycle ends, the **LOCK** indicator word will turn off. The oven door can be opened.

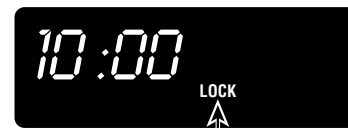

LOCK IS STILL ENGAGED.  
DOOR CANNOT BE  
OPENED UNTIL LOCK IS  
NO LONGER DISPLAYED.

# Care & Cleaning (continued) .....

## After Self-Cleaning

*About one hour after the end of the clean cycle, the LOCK indicator word will turn off. At this point, the door can be opened.*

Some soil may leave a light gray, powdery ash which can be removed with a damp cloth. If soil remains, it indicates that the clean cycle was not long enough. The soil will be removed during the next clean cycle.

If the oven racks were left in the oven and do not slide smoothly after a clean cycle, wipe racks and embossed rack supports with a small amount of vegetable oil to restore ease of movement.

A white discoloration may appear after cleaning if acid or sugary foods were not wiped up before the clean cycle. This discoloration is normal and will NOT affect performance.

### To Delay the Start of a Clean Cycle:

- 1 - 3. Follow steps 1-3 on previous page.
4. Press **STOP TIME** pad.
  - a. Press  or  pad to select the time of day you wish the oven to turn off.
  - b. Press **CLOCK** pad and time of day will reappear in display.
  - c. DELAY CLEAN will remain in display to show the oven is set for delayed clean operation.
5. When the oven turns on the clean symbol will light in the display.
6. About one hour after the clean cycle ends, the LOCK indicator word will turn off. The oven door can be opened.

### To Cancel a Clean Cycle:

1. Press **CANCEL** pad.
2. If LOCK is NOT displayed, open oven door.

If LOCK is displayed, allow oven to cool about one hour then open oven door.

### Notes...

- When the LOCK indicator word lights in the display, the door cannot be opened. To prevent damage to the door, do not force door open when the LOCK indicator word is displayed.
- **A fan will automatically turn on during the self-clean cycle and will automatically turn off after the clean cycle when the oven has cooled. If it does not operate, contact an authorized servicer.**
- If more than 30 seconds elapse between pressing the **CLEAN** pad and pressing a  or  pad, the program will automatically return to the previous display.
- The first few times the oven is cleaned, some smoke and odor may be detected. This is normal and will lessen or disappear with use. If the oven is heavily soiled, or if the broiler pan was accidentally left in the oven, excessive smoke and odor may occur.
- As the oven heats and cools, you may hear sounds of metal parts expanding and contracting. This is normal and will not damage your appliance.

**⚠ Cleaning CAUTIONS:**

- Be sure appliance is off and all parts are cool before handling or cleaning. This is to avoid damage and possible burns.
- To prevent staining or discoloration, clean appliance after each use.
- If a part is removed, be sure it is correctly replaced.

## Cleaning Chart

Parts	Cleaning Procedure
<b>Broiler Pan and Insert</b>	<p><i>Never cover insert with aluminum foil as this prevents the fat from draining to the pan below.</i></p> <ul style="list-style-type: none"> <li>• Place soapy cloth over insert and pan; let soak to loosen soil.</li> <li>• Wash in warm soapy water. Use soap filled scouring pad to remove stubborn soil.</li> <li>• Broiler pan and insert can be cleaned in dishwasher.</li> </ul>
<b>Control Panel</b>	<ul style="list-style-type: none"> <li>• To activate “Control Lock” for cleaning , see page 5.</li> <li>• Wipe with a damp cloth. Dry thoroughly.</li> <li>• Glass cleaners may be used if sprayed on a cloth first. <b><i>Do Not Spray Directly on the Panel.</i></b></li> <li>• Do not use other cleaning sprays, abrasive cleaners or large amounts of water on the panel.</li> </ul>
<b>Glass</b> - Oven window - Oven door (select models)	<ul style="list-style-type: none"> <li>• Wash with soap and water or glass cleaner. Avoid using excessive amounts of water which may seep under or behind glass.</li> <li>• Do not use abrasive cleaners.</li> </ul>
<b>Metal Finishes</b> - Oven Trim	<ul style="list-style-type: none"> <li>• Wash with soap and water, glass cleaners, or mild liquid sprays. Avoid using excessive amounts of water.</li> <li>• Remove stubborn soils with nonabrasive cleaners such as Bon Ami* or a baking soda and water paste; rinse and dry. Do not use abrasive cleaners.</li> </ul>
<b>Oven Interior</b>	<p><b>Manual Clean</b> (lower oven only, select models)</p> <ul style="list-style-type: none"> <li>• Clean frequently using mild abrasive cleaners and a plastic pad. Do not use metallic scouring pads because they will scratch the surface.</li> <li>• When using commercial oven cleaners, follow the manufacturer’s instructions.</li> </ul> <p><b>Self-Clean</b></p> <ul style="list-style-type: none"> <li>• Wipe up sugary and acid spillovers such as lemon juice, tomato sauce or milk-based sauces. Porcelain enamel is acid resistant, not acid proof. The porcelain finish may discolor if acid spills are not wiped up prior to a self-clean cycle.</li> <li>• See pages 12 and 13 for information on the self-clean oven.</li> <li>• To remove occasional spillovers between cleanings, use a plastic, soap-filled scouring pad; rinse well.</li> </ul>
<b>Oven Racks</b>	<ul style="list-style-type: none"> <li>• Rub with a sponge or cloth using one of the following cleaners: Bon Ami, Soft Scrub or Comet*. Rinse and dry.</li> <li>• For hard to remove soils, use a dampened soap-filled scouring pad. Rinse and dry.</li> <li>• Racks will permanently discolor and may not slide smoothly if left in the oven during a self-clean operation. If this occurs, wipe the rack and embossed rack supports with a small amount of vegetable oil to restore ease of movement, then wipe off excess oil.</li> </ul>

# Care & Cleaning (continued) .....

Cleaning Chart -- continued	
Parts	Cleaning Procedure
<b>Plastic Finishes</b> - Door Handle Area	<ul style="list-style-type: none"> <li>• Wash with soap and water or mild liquid sprays and a soft cloth. Do not use abrasive cleaners or oven cleaners on plastic finishes.</li> <li>• To prevent staining or discoloration, wipe up fat, grease or acid (tomato, lemon, vinegar, milk, fruit juice, marinade) immediately with a dry paper towel or cloth.</li> <li>• Never use oven cleaners, abrasive or caustic liquid or powdered cleansers on plastic finishes. These cleaning agents will scratch or mar finish.</li> </ul>
<b>Brushed Chrome</b> (select models)	<ul style="list-style-type: none"> <li>• When cool, wash with soapy water, rinse and buff the surface.</li> <li>• For heavier soil, use a mild abrasive cleaner, rubbing with the grain to avoid streaking the surface. Rinse and buff.</li> <li>• To prevent scratching, do not use abrasive or caustic agents.</li> <li>• To restore luster and remove streaks, follow with Stainless Steel Magic Spray* (Part #20000008)**.</li> </ul> <p><i>Chrome will permanently discolor if soil is allowed to bake on.</i></p>

\* Brand names are trademarks of the respective manufacturers.

\*\* To order direct, call 1-800-688-8408.



## Maintenance .....

### Oven Light

Before replacing light bulb, DISCONNECT POWER TO OVEN. Be sure bulb is cool. Do not touch a hot bulb with a damp cloth as the bulb may break.

#### To replace oven light:

Use a dry potholder and very carefully unscrew bulb cover and bulb. Replace with a 40 watt, oven-rated appliance bulb. Bulb with a brass base is recommended to prevent fusing of bulb into socket.

Replace bulb cover and reconnect power to oven. Reset clock.

### Oven Window

#### To protect the oven door window:

1. Do not use abrasive cleaning agents such as steel wool scouring pads or powdered cleansers as they may scratch the glass.
2. Do not hit the glass with pots, pans, furniture, toys, or other objects.
3. Do not close the oven door until the oven racks are in place.

Scratching, hitting, jarring or stressing the glass may weaken its structure causing an increased risk of breakage at a later date.





# Before You Call For Service .....

## Check these points if . . .

**The oven fails to operate.**

- check for a blown fuse or a tripped circuit breaker.
- check if oven is properly connected to electric outlet.

**Clock, indicator words, and/or lights operate but oven does not heat.**

- the controls may have been set incorrectly.
- clock controls may be set for a delayed bake function.
- the Oven Control Lockout may have been set. (See page 5.)

**The oven light and/or clock does not function.**

- the light bulb is loose or defective.
- check power supply, circuit breaker or fuse.
- the oven light does not work during self-cleaning process.

**There is a strong odor or light smoke when oven is turned on.**

- this is normal for a new wall oven and will disappear after a few uses. Initiating a clean cycle will “burn off” the smells more quickly. Turning on a ventilation fan will help remove the smoke and/or odor.
- excessive food soils on the oven bottom. Use a self-clean cycle.

**Oven will not activate the self-cleaning process.**

- controls may be improperly set.
- check if set for delayed start.

**Oven did not clean properly.**

- oven may need longer cleaning time.
- excessive spills were not removed prior to self-cleaning process.

**Foods do not broil properly.**

- control may be improperly set.
- check rack position. (See page 10.)
- voltage into house may be low.
- broil element was not preheated.
- oven door was closed during broiling. Leave the door open to the first stop position.

**Baked food is burned or too brown on top.**

- food may be positioned incorrectly in oven. (See “*Cooking Made Simple*” booklet.)
- oven not preheated properly.

**Foods bake unevenly.**

- the oven may be installed improperly.
- check the oven rack with a level.
- stagger pans, do not allow pans to touch each other or oven wall.
- check instructions for suggested placement of pans on oven rack. (See “*Cooking Made Simple*” booklet.)

**Oven door will not unlock.**

- oven may not have cooled to safe temperature after self-cleaning process.

# Before You Call for Service (continued) .....

**Oven baking results are less than expected.**

- the pans being used may not be of the size or material recommended for best results. (See “*Cooking Made Simple*” booklet).
- there may not be sufficient room around sides of the pans for proper air circulation in the oven.
- check instructions for preheating, rack position and oven temperature.
- check oven temperature when convection baking (select models). Decrease conventional baking temperatures by 25° F.

**Baking results differ from previous oven.**

- oven thermostat calibration may differ between old and new ovens. Follow recipe and use the directions in this guide before calling for service since the calibration on the previous oven may have drifted to a too high or too low setting. (See p. 6 - Oven Temperature Adjustment.)

**The cooling fan continues to operate after the oven has been turned off.**

- this is normal. The fan will automatically shut off when the oven is cooled.

**A fan sound can be heard.**

- this is the cooling fan and is normal. The fan will continue to run after use until the oven cools.

**Fault Codes**

- fault codes are shown in the display as “F” and a number. If a fault code appears in the display and beeps sound, press the **CANCEL** pad. If the fault code and beeps continue after pressing cancel, disconnect power to the wall oven. Wait a few minutes, then reconnect power to the oven. If the fault code and beeps still continue, disconnect power to the wall oven and call an authorized servicer.
- if the oven is heavily soiled, excessive flare-ups may result in a fault code during a clean cycle. Press **CANCEL** pad and allow the oven to cool for one hour, then reset the clean cycle. If the fault code and beeps still continue, disconnect power to the appliance and call an authorized servicer.

## ***If You Need Service***

- Call the dealer from whom your appliance was purchased or call Maytag Appliances Sales Company, Maytag Customer Assistance at 1-800-688-9900, USA or 1-800-688-2002, CANADA to locate an authorized servicer.
- Be sure to retain proof of purchase to verify warranty status. Refer to WARRANTY (last page) for further information on owner's responsibilities for warranty service.
- If the dealer or service company cannot resolve the problem, write to Maytag Appliances Sales Company, Attn: CAIR® Center, P.O. Box 2370, Cleveland, TN 37320-2370, or call **1-800-688-9900, USA or 1-800-688-2002, CANADA.**

U.S. customers using TTY for deaf, hearing impaired or speech impaired, call 1-800-688-2080.

**NOTE:** When writing or calling about a service problem, please include the following information:

- a. Your name, address and telephone number;
  - b. Model number and serial number;
  - c. Name and address of your dealer or servicer;
  - d. A clear description of the problem you are having;
  - e. Proof of purchase (sales receipt).
- User's guides, service manuals and parts information are available from Maytag Appliances Sales Company, Maytag Customer Assistance.



# Maytag Wall Oven Warranty .....

## Full One Year Warranty - Parts and Labor

For **one (1) year** from the original retail purchase date, any part which fails in normal home use will be repaired or replaced free of charge.

## Limited Warranties - Parts Only

**Second Year** - After the first year from the original purchase date, parts which fail in normal home use will be repaired or replaced free of charge for the part itself, with the owner paying all other costs, including labor, mileage and transportation.

**Third Through Fifth Year** - From the original purchase date, parts listed below which fail in normal home use will be repaired or replaced free of charge for the part itself, with the owner paying all other costs, including labor, mileage and transportation.

- **Electronic Controls**
- **Electric Heating Elements:** broil and bake elements on electric cooking appliances.

## Canadian Residents

The above warranties only cover an appliance installed in Canada that has been certified or listed by appropriate test agencies for compliance to a National Standard of Canada unless the appliance was brought into Canada due to transfer of residence from the United States to Canada.

## Limited Warranty Outside the United States and Canada - Parts Only

For two (2) years from the date of original retail purchase, any part which fails in normal home use will be repaired or replaced free of charge for the part itself, with the owner paying all other costs, including labor, mileage and transportation.

*The specific warranties expressed above are the **ONLY** warranties provided by the manufacturer. These warranties give you specific legal rights, and you may also have other rights which vary from state to state.*

## What is Not Covered By These Warranties:

1. Conditions and damages resulting from any of the following:
  - a. Improper installation, delivery, or maintenance.
  - b. Any repair, modification, alteration, or adjustment not authorized by the manufacturer or an authorized servicer.
  - c. Misuse, abuse, accidents, or unreasonable use.
  - d. Incorrect electric current, voltage, or supply.
  - e. Improper setting of any control.
2. Warranties are void if the original serial numbers have been removed, altered, or cannot be readily determined.
3. Light bulbs.
4. Products purchased for commercial or industrial use.
5. The cost of service or service call to:
  - a. Correct installation errors.
  - b. Instruct the user on the proper use of the product.
  - c. Transport the appliance to the servicer.
6. Consequential or incidental damages sustained by any person as a result of any breach of these warranties.

Some states do not allow the exclusion or limitation of consequential or incidental damages, so the above exclusion may not apply.

**MAYTAG • 403 West Fourth Street North • P.O. Box 39 • Newton, Iowa 50208**