

COBY®

DP-768



7" Widescreen TFT LCD Digital Photo Frame
with Video and Music Playback



INSTRUCTION MANUAL

Please read this manual carefully before operation

Precautions

	CAUTION WARNING: SHOCK HAZARD. DO NOT OPEN. AVIS: RISQUE DE CHOC ELECTRIQUE. NE PAS OUVRIR	
CAUTION: TO REDUCE THE RISK OF FIRE AND ELECTRIC SHOCK, DO NOT REMOVE THE COVER (OR BACK) OF THE UNIT. REFER SERVICING ONLY TO QUALIFIED SERVICE PERSONNEL.		



The lightning flash with arrowhead symbol within an equilateral triangle is intended to alert the user to the presence of uninsulated “dangerous voltage” within the product’s enclosure that may be of sufficient magnitude to constitute a risk of electric shock.



The exclamation point within an equilateral triangle is intended to alert the user to the presence of important operation and servicing instructions in the literature accompanying the appliance.

For Customer Use:

Enter below the serial number that is located on the bottom of the unit. Retain this information for future reference.

Model No. _____ DP-768 _____

Serial No. _____



For recycling or disposal information about this product, please contact your local authorities or the Electronics Industries Alliance: www.eiae.org.

Precautions

WARNING:

To prevent fire or shock hazard, do not expose this device to rain or moisture. Dangerous high voltage is present inside the enclosure. Do not open the cabinet.

CAUTION:

To prevent electric shock, match wide blade of plug to wide slot of outlet and fully insert.

CAUTION:

Changes or modifications not expressly approved in this manual could void your authority to operate this equipment.

Protect your hearing:

Hearing experts advise against the constant use of personal stereos played at high volume. Constant exposure to high volumes can lead to hearing loss. If you should experience ringing in the ears or hearing loss, discontinue use and seek medical advice.

NOTICE:

The LCD panel used in this player contains millions of thin film transistors that have been manufactured using a high-technology process to deliver a crisp, clear, and detailed picture. Occasionally, a few of these transistors may become stuck or non-active; please note that this is a normal result of the manufacturing process and does not affect the performance of the player.

Important Safety Instructions

1. Read these instructions.
2. Keep these instructions.
3. Heed all warnings.
4. Follow all instructions.
5. Do not use this apparatus near water.
6. Clean only with dry cloth.
7. Do not block any ventilation openings. Install in accordance with the manufacturer's instructions.
8. Do not install near any heat sources such as radiators, heat registers, stoves, or other apparatus (including amplifiers) that produce heat.
9. Do not defeat the safety purpose of the polarized or grounding-type plug. A polarized plug has two blades with one wider than the other. A grounding type plug has two blades and a third grounding prong. The wide blade or the third prong are provided for your safety. If the provided plug does not fit into your outlet, consult an electrician for replacement of the obsolete outlet.
10. Protect the power cord from being walked on or pinched particularly at plugs, convenience receptacles, and the point where they exit from the apparatus.
11. Only use attachments/accessories specified by the manufacturer.
12. Use only with the cart, stand, tripod, bracket, or table specified by the manufacturer, or sold with the apparatus. When a cart is used, use caution when moving the cart/apparatus combination to avoid injury from tip-over.
13. Unplug this apparatus during lightning storms or when unused for long periods of time.
14. Refer all servicing to qualified service personnel. Servicing is required when the apparatus has been damaged in any way, such as power-supply cord or plug is damaged, liquid has been spilled or objects have fallen into the apparatus, the apparatus has been exposed to rain or moisture, does not operate normally, or has been dropped.



Caution

- Never push objects of any kind into this product, through openings or otherwise; this may result in objects touching dangerous voltage points or short-out parts that could result in a personal or property damage or injury, including fire or electric shock. Never spill liquid of any kind on the product.
- Ventilation: Any electrically powered consumer electronic product generates heat while in use, thereby requiring proper ventilation. To ensure reliable operation of the product and to protect it from overheating, do not operate the product on a bed, sofa, rug, or other similar soft surface, and never block any ventilation slots or openings provided for the unit. This product should not be operated in any enclosed area such as a cabinet, bookcase or rack unless proper ventilation is provided for the unit.

Important Safety Instructions

- Water is a natural conductor of electricity. To avoid the possibility of shock or severe injury, do not use this product in or near any sources of water (e.g., a bath tub, washbowl, kitchen sink, laundry tub, in wet basements, a swimming pool and the like).
- Power Sources: This product should be operated only from the type of power source indicated on the rating label. If you are not sure of the type of power supply to your home, consult your product dealer or local power company. For products intended to operate from battery power or other sources, refer to the operating instructions.
- Lightning can cause power surges, which may damage or destroy your product. For added protection, unplug it from the wall outlet and disconnect the antenna or cable system during a lightning storm or when it is left unattended and unused for long periods of time.
- Overloading: Always operate any electrical device in accordance with applicable electrical codes. Never overload wall outlets, extension cords, or integral convenience receptacles as this can result in a risk of personal or property damage or injury, including fire or electric shock.
- Servicing: Do not attempt to service this product yourself as opening or removing covers may expose you to dangerous voltage or other hazards, including the risk of injury or damage to persons or property. Your warranty will also be voided. Refer all servicing to qualified service personnel.
- Damage Requiring Service: Unplug this product from the wall outlet and refer servicing to qualified service personnel if: a) the power-supply or plug is damaged in any way; b) liquid has been spilled or if objects have fallen or been introduced into the product; c) the product has been exposed to rain, water or other sources of moisture; d) the product does not operate normally by following the operating instructions. Adjust only those controls that are covered by the operating instructions as improper adjustment of other controls may result in damage and/or require extensive work by a qualified service technician to restore the product to its normal operation; e) the product has been dropped or damaged in any way; f) the product exhibits a distinct change in performance indicative of a need for service.
- Replacement Parts: When replacement parts are required, be sure that your service technician has used replacement parts specified by the manufacturer or have the same characteristics as the original part. Unauthorized substitutions may result in injury to property or persons including the risk of fire, electric shock, or other hazards, and your warranty will be voided.
- Safety Check: Upon completion of any service or repairs to this product, ask the service technician to perform appropriate safety checks to ensure that the product is in proper operating condition.
- Wall or Ceiling Mounting: The product should be mounted to a wall or ceiling only as recommended by the manufacturer.

Table of Contents

PRECAUTIONS	2
IMPORTANT SAFETY INSTRUCTIONS.....	4
TABLE OF CONTENTS	6
PACKAGE CONTENTS	8
FEATURES	9
LOCATION OF CONTROLS.....	10
Main Unit	10
Remote Control	12
Installing a Battery in the Remote Control.....	13
Using the Remote Control	14
GETTING STARTED	15
Installing a Memory Card.....	15
Connecting Power to your Frame	16
Turning Your Photo Frame On/Off	16
PLAYING YOUR FILES	17
File Browser Menu	17
Using the File Browser Interface	18
File Type Icons	18
Extended Settings.....	19
Card Selection Menu	20
Photo Viewer	21
Photo Viewer Controls	21
Photo Slideshow	22
Audio/Video Player	23
Audio/Video Player Controls	23
SETUP MENU	25
Language Options.....	25
Photo Options	26
Reset Options	27

Table of Contents

OPTIONAL CONNECTIONS	28
Headphones.....	28
Audio Out	28
Composite Video.....	29
CHANGING THE FACEPLATE	30
FIRMWARE UPGRADES.....	32
TROUBLESHOOTING	33
SPECIFICATIONS	35

Package Contents

Please make sure that the items shown below are included in the package. Should an item be missing, please contact the local retailer from which you purchased this product.

1. COBY DP-768
2. Remote Control
3. Two Wooden Frames (Maple and Black)
4. AC Adapter
5. Manual

Features

- 7" Widescreen TFT LCD Color Display
- Displays JPEG Image Files
- Plays MP3 and WMA Audio Files
- Plays AVI, MPG, and XviD Video Files
- AV Output for use with Home Theater Systems
- SD, MMC, MS, xD, and CF Card Slots
- Full-Size USB Port for use with Flash Memory Drives
- Integrated Stereo Speakers
- Two Interchangeable Frames
- Wall Mountable Design with Detachable Stand

Location of Controls

Main Unit

Front View

1. Remote Sensor
2. 7" TFT LCD (16:9)

Rear View

3. Frame Clip
4. Mounting Hole
5. Speaker
6. Detachable Stand

Top View

7. **Menu/Setup**
Press once for Menu;
Press and hold for Setup
8. **Enter/Slideshow**
Press once for Enter;
Press and hold for Slideshow
9. Down
10. Up
11. **Left/Volume Down**
Press once for Left;
Press and hold for Volume Down
12. **Right/Volume Up**
Press once for Right;
Press and hold for Volume Up
13. Volume Level Dial

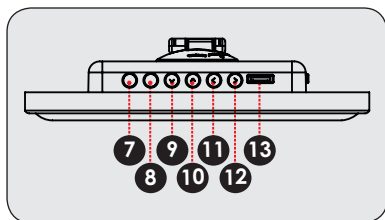
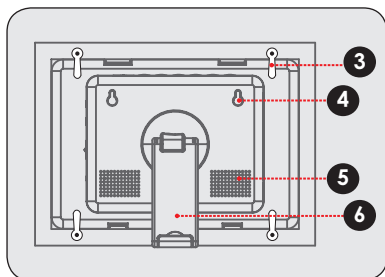
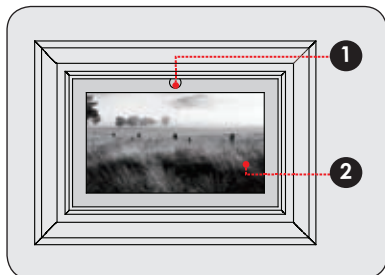

Location of Controls

Left View

- 14. Compact Flash (CF)
- 15. Memory Stick (MS)
- 16. xD-Picture (xD)
- 17. Secure Digital (SD) /
Multi Media Card (MMC)
- 18. USB Full-Size
(for use with USB flash drives)

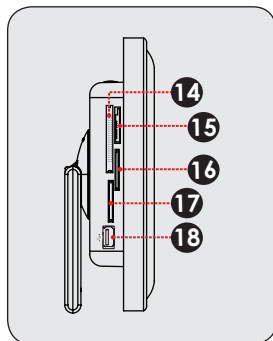





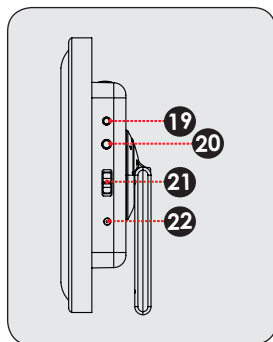

Right View

- 19. Video Out
- 20. Headphone / Audio Out
- 21. Power Switch (On / Off)
- 22. Power In Jack



Location of Controls

Remote Control

1. Menu 
2. Aspect Ratio 
3. Play / Pause 
4. Zoom 
5. Up (Navigation) 
6. Left (Navigation) 
7. Down (Navigation) 
8. Right (Navigation) 
9. Enter 
10. Stop 
11. Previous / Reverse 
12. Next / Forward 
13. Volume Down 
14. Volume Up 
15. Angle 
16. Setup 
17. Slideshow 

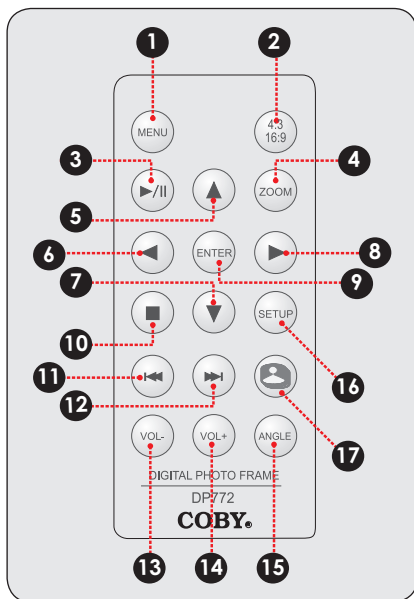

Location of Controls

Installing a Battery in the Remote Control

The remote control requires one “CR2025” battery. To load a battery in the remote:

1. Slide the compartment out in the direction of the arrow.
2. Place the battery in the compartment with the positive side (+) facing up.
3. Push the compartment in to close.

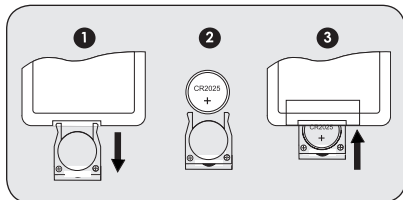

Batteries will last for about one year under typical usage. Replace the batteries if the remote is no longer working.

Remove the battery if the remote control will not be in use for an extended period of time.



The battery used in this device may present a fire or chemical hazard if mistreated. Do not recharge, disassemble, incinerate, or heat the batteries.

Used batteries should be disposed of safely and not incinerated. Attention should be shown to the environment aspects of battery disposal.

Keep batteries out of the reach of children.

Location of Controls

Using the Remote Control

- Point the remote at the remote sensor of the photo frame at a distance of no more than 15' and at an angle no greater than 60 degrees.



Do not spill water on the remote control.

Do not use the remote control for other equipment at the same time.

Getting Started

To start playing photos, music, and videos on your digital photo frame, you will need to:

1. Install a memory card with compatible photo, music, and/or video files.
2. Connect your photo frame to a power source.
3. Turn on the photo frame.

Installing a Memory Card

Your photo frame supports the following types of memory cards:

- Secure Digital cards (SD)
- MultiMedia Card (MMC)
- Compact Flash cards (CF)
- xD-Picture card (xD)
- Memory Stick (MS)

Simply insert the memory card of your choice into its corresponding card slot located on the left panel of the photo frame. Take care to orient the card in the proper direction.

Additionally, a full-size USB port is provided for use with USB flash memory drives.



MS and SD cards cannot be installed for use at the same time.

Getting Started

Connecting Power to your Frame

Your Photo Frame should be connected to an AC 100-240V wall outlet.

- Using the supplied power adapter, plug one end of the adapter into your photo frame's Power In Jack and plug the other end into an AC 100-240V wall outlet.

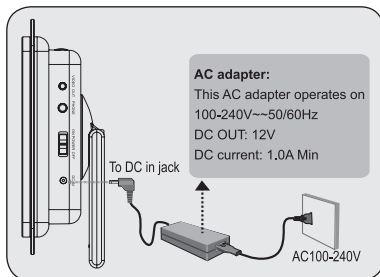

Do not connect the power plug to a power outlet other than that which is indicated here or on the label as this may result in the risk of fire or electric shock.

Do not handle the power plug with wet hands. Doing so may cause electric shock.

Use only the AC adapter supplied with the photo frame. Failure to do so may cause a fire or damage the player.

Turning Your Photo Frame On/Off

- To turn your photo frame on, set the Power Switch to the "On" position.
- To turn your photo frame off, set the Power Switch to the "Off" position.



If no memory cards have been loaded, the photo frame will automatically display a demo slideshow after 10 seconds. To stop the demo slideshow, press any button or load a card.

Playing Your Files

File Browser Menu

The File Browser allows you to view and play photos, music, and videos from any memory cards loaded into your photo frame.

Load a card into its corresponding slot and turn on the player. The photo frame will display the File Browser menu shown below.

You can also access the File Browser menu at any time by pressing .



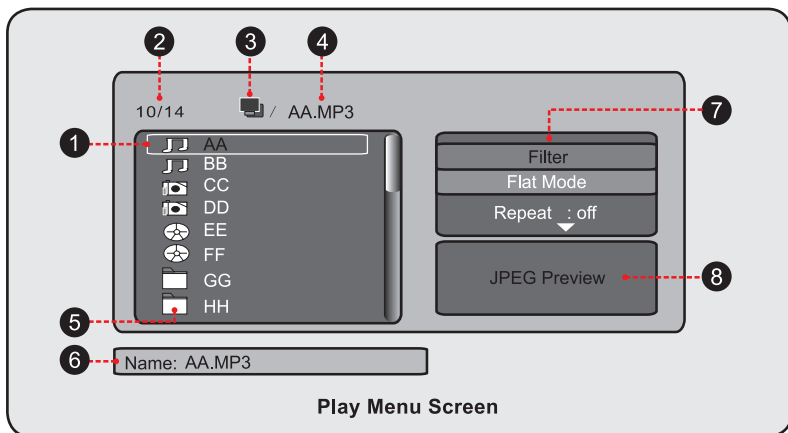







- To play a file, use the navigation keys to select a file and press  to start playback.







- | | |
|--|---|
| 1. Selected File | 5. File Type Icon |
| 2. Number of Selected File / Total Number of Files | 6. Extended Information of Selected File (if available) |
| 3. Current Card Icon | 7. Extended Settings |
| 4. Name of Selected File | 8. Thumbnail Preview |

Playing Your Files

Using the File Browser Interface

- Use the Navigation keys to make a selection:
 - To move the selection up, press .
To scroll up quickly, press and hold .
 - To move the selection down, press .
To scroll down quickly, press and hold .
 - To move the selection left, press .
To scroll left quickly, press and hold .
 - To move the selection right, press .
To scroll right quickly, press and hold .
 - **Press  to confirm the highlighted selection.**
- To return to the previous screen/folder, press .
- To change the selected memory card, press  until the Card Selection menu appears.

File Type Icons

Icon	Description
	Photo File
	Audio (Music) File
	Video File
	Folder
	Previous Folder (Up)

Playing Your Files

Extended Settings

Filter

Choose which types of files will be displayed (Audio, Photo, or Video).

- If there is no checkmark next to the type, those files will not be displayed in the list.

Flat Mode

Turn Flat Mode on or off. When Flat Mode is on, all files loaded on the memory card will be played.

Additionally, there are 2 Flat Mode options that you can set.

- Repeat: Off, Single, Folder, All
- Mode: Normal, Shuffle, Intro (for Audio only).





When Flat Mode is set to off, only audio files will be played.

Program

Use the Program List to customize the order in which files will play.



Edit Mode must be set to "On" for all functions to be available.

1. Use the Navigation Keys to select Edit Mode in the Extended Settings.
2. Select files from the list and press  to mark them with a check. To remove the check, press  again.
3. Select and confirm "Add to Program". This will add the marked files to the Program List
4. To view the Program List, select and confirm "Program View".

Playing Your Files

To play the Program List:

- Make sure that Edit Mode is set to “Off”.
- Select a file in the Program List and press  to start playback. The files in the Program List will be played in sequence automatically.

To add more files to the Program List:





- When the frame is in Program View, select and confirm “Browser View”. Repeat Steps 1 to 4 to add files to the Program List.

To remove files from the Program List:

- Make sure that Edit Mode is set to “Off” and that the frame is in “Program View”.
- Select files from the Program List and press  to mark them with a check.
- Select “Clear Program” to remove the marked files.

Card Selection Menu

If multiple memory cards have been loaded, use the Card Selection menu to view files on a different card.

- From the Play Menu screen, press  until the Card Selection menu appears.
- Press  or  to select a card and then press  to confirm. The photo frame will load the contents of the card and display the Play Menu screen.

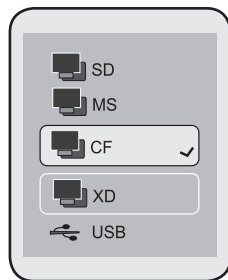

MS and SD cards cannot be installed for use at the same time.

Playing Your Files













Photo Viewer

To start viewing your photos, select a photo file from the File Browser menu and press . The Photo Viewer will launch and display your photo in full-screen mode.



The photo frame will display compatible photo files, only. Baseline JPEG files of up to 8MB and 32 million pixels are supported.

Photo Viewer Controls

Remote Key	Frame Button	Description
		View the next photo.
		View the previous photo.
	Hold ENTER/ SLIDESHOW	Toggle the photo slideshow on or off.
	ENTER/ SLIDESHOW	Pause the photo slideshow.
 or 	MENU	Stop and return to the File Browser menu.
	--	Change the magnification level of the displayed photo. Each successive press of  will change the magnification level as shown below: Q 1 → Q 2 → Q 3 → Q OFF
	--	Rotate the displayed photo. Each successive press of  will rotate the photo 90 degrees in a clockwise direction (90, 180, 270, No Rotation).

Playing Your Files



Remote Key	Frame Button	Description
	--	Change the aspect ratio of the display. Each successive press of  will toggle the display between a 4:3 (standard) or 16:9 (widescreen) aspect ratio.



Photo Viewing options may be set in the Setup menu. Please refer to the “Setup” section of this manual for more information.

Photo Slideshow

The slideshow function is enabled automatically when viewing your photos. When the slideshow function is enabled, the next photograph in the list will be displayed automatically after a predetermined length of time.





- To toggle the slideshow function off or on, press .
- To manually view the next photo, press .
- To manually view the previous photo, press .
- To change the length between transitions, change the option in the Setup menu. Please refer to the Setup section of this manual for more information.



Photo Slideshow options may be set in the Setup menu. Please refer to the “Setup” section of this manual for more information.

Playing Your Files











Audio/Video Player

To start playing music or video, select an audio or video file from the File Browser menu and press .



The photo frame will play compatible audio and video files, only. MP3 and WMA audio files and AVI (XviD), MPG, and MPEG video files are supported.

Audio/Video Player Controls

Remote Key	Frame Button	Description
	--	Play the next file.
	--	Play the previous file.
		Change the rate of forward playback (fast forward). Each successive press will change the rate as follows: ▶ x 2 ⇒ ▶▶ x 4 ⇒ ▶▶▶ x 8 ⇒ ▶▶▶▶ x 16 Press  to resume normal playback.
		Change the rate of reverse playback (rewind). Each successive press will change the rate as follows: ◀ x 2 ⇒ ◀◀ x 4 ⇒ ◀◀◀ x 8 ⇒ ◀◀◀◀ x 16 Press  to resume normal playback.
	ENTER/ SLIDESHOW	Play or pause the file.
	MENU	Stop playback.
	Volume Level Dial	Increase the volume level.

Playing Your Files



Remote Key	Frame Button	Description
	Volume Level Dial	Decrease the volume level.



Repeat and Shuffle playback options may be set in the Flat Mode settings. Please refer to the “Playing Your Files > Extended Settings > Flat Mode” section of this manual for more information.

Setup Menu

To adjust the settings and options of your digital photo frame, press . The Setup Menu be displayed on screen.

- Use the navigation keys to highlight and display option / sub-menu.
- To confirm a selection, press .
- To return to a previous menu level, press .
- To exit the Setup Menu, press .



Please choose your desired settings as shown in the screens below. The options marked “✓” are the default settings.

Language Options

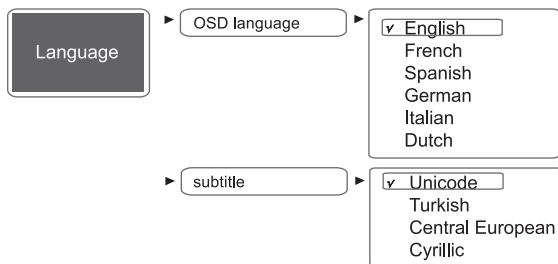

- OSD Language: Sets the language of the on-screen display.
- Subtitle: Sets the language of the video subtitle. The video file must have subtitle support for this option to work.

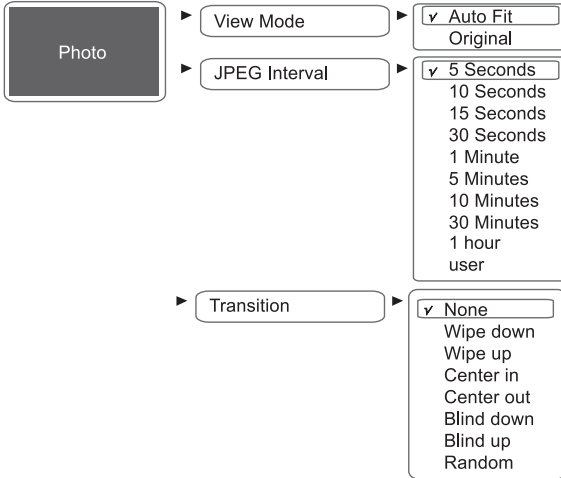

Setup Menu

Photo Options



- View Mode: The Auto Fit setting will scale photographs to best fit the display.
- JPEG Interval: Sets the interval between slideshow transitions.
- Transition: Sets the slideshow transition type.



When the Transition option is set to "User", the photo slideshow function will not automatically transition to the next photo. Press  or  to manually transition to the previous or next photo, respectively.

Setup Menu

Reset Options

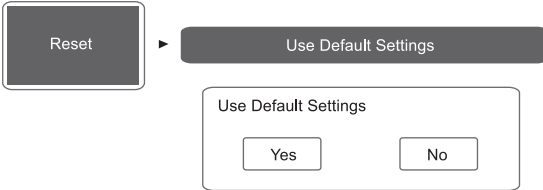

- Select and confirm "Yes" to restore the default settings of the photo frame.

Optional Connections

Your digital photo frame comes equipped with stereo audio and video output jacks.



Disconnect power from the photo frame and all additional components prior to making these connections.

Headphones

Connect the Headphone / Audio Out jack to a pair of headphones or earphones for private listening. Audio output to the speakers will be disconnected automatically when a pair of headphones are in use.

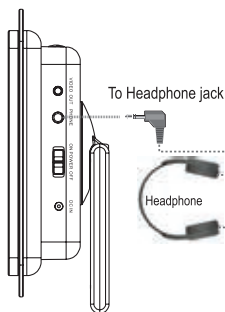

- Be sure that your unit is at low volume level before connecting the headphone.
- Increase the volume gradually to a comfortable listening level.

CAUTION:

Hearing experts advise against the constant use of personal stereos played at high volume. Constant high volume use can lead to hearing loss. If you experience ringing in the ears or hearing loss, discontinue use and seek medical advice.

Audio Out

Connect the Headphone / Audio Out jack to a pair of speakers, a stereo TV, or an amplifier for audio output only.



An audio connection cable terminating in a 3.5mm plug is required to make this connection.

Optional Connections

Composite Video

Connect the Video Out jack to a TV or monitor with composite video input capability for video output. Combine this connection with the Audio Out connection for Audio and Video output to a TV with AV Input jacks or a home theater system.



A composite video connection cable terminating in a 3.5mm plug is required to make this connection.

Please refer to the instruction manual of your TV for more guidance.

Changing the Faceplate

Your digital photo frame comes equipped with interchangeable faceplates to match your home decor.

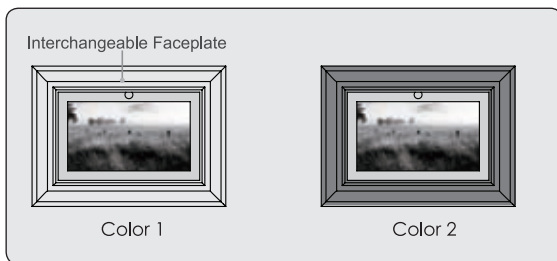

To detach a faceplate from your photo frame:

1. Rotate the clips on the rear of the frame in the direction indicated by the arrows in the diagram.
2. The main unit may now be separated from the faceplate.

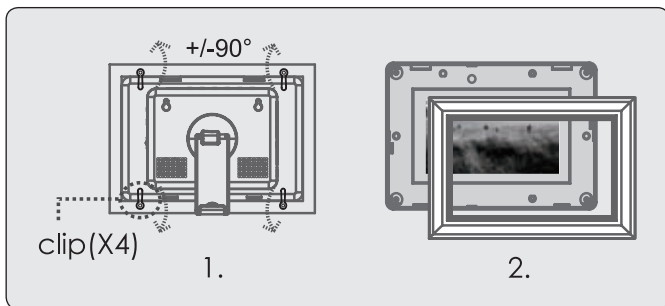

Changing the Faceplate

To attach a faceplate to your photo frame:

1. Place the front of the main unit into the rear of the faceplate.
2. Rotate the clips on the frame in the direction indicated by the arrows in the diagram so that the frame is secured to the main unit.

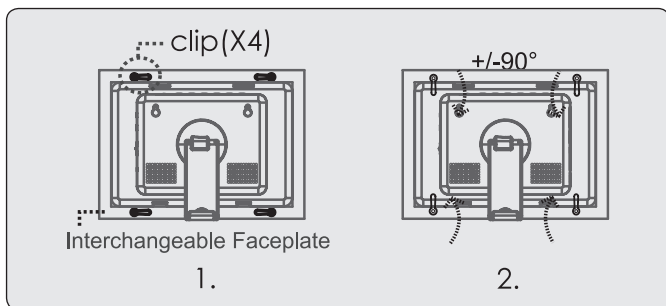

Firmware Upgrades

From time to time, COBY may release firmware updates to improve the performance of the DP-768 or to add additional features. Please check the COBY website periodically at www.cobyusa.com to see if new firmware has been released for your photo frame.

Troubleshooting

If you have a problem with this unit, please read the troubleshooting guide below and check our website at www.cobyusa.com for Frequently Asked Questions (FAQs) and firmware updates. If these resources do not resolve the problem, please contact Technical Support.

COBY Electronics Technical Support

56-65 Rust Street
Maspeth, NY 11378

Email: techsupport@cobyusa.com

Web: www.cobyusa.com

Phone: 800-727-3592 (8:00 AM–11:00 PM EST, seven days a week)
800-681-2629 (8:00 AM–5:30 PM EST, Monday to Friday)
718-416-3197 (8:00 AM–5:30 PM EST, Monday to Friday)

The player does not turn on.

- Make sure the unit has been powered on manually (i.e., the Power Switch has been physically set to the ON position).
- Ensure that the power cord has been properly connected to the power outlet.

I cannot select a memory card.

- Ensure that a memory card or USB flash drive has been properly installed.
- Ensure that the memory card or USB flash drive is not defective.

The player will not play my music file.

- Ensure that the file is in a compatible format (MP3 or WMA).
- The file may be copy-protected. This player cannot play copy-protected files.

The player will not play my video file.

- Ensure that the video file will play on your computer using Windows Media Player 10. If the file works on the computer, use the same computer to convert the video to a compatible format.

Troubleshooting

The sound quality of the music is poor.

- Try playing the file on your computer. If the sound quality is still poor, try downloading the file again or re-encoding the file yourself.
- Ensure that the bit rate of the file is not too low. The higher the bit rate of the file, the better it will sound. The minimum recommended bitrate is 128kbps for MP3s and 96kbps for WMAs.

The picture is noisy or distorted when connected to a TV.

- Reset the color system of the TV set.
- Ensure that the photo frame is connected using an RCA composite video cable.

There is no sound.

- Ensure that the volume has been set to a reasonable level.

The remote control does not work.

- Make sure the unit has been powered on manually (i.e., the Power Switch has been physically set to the ON position).
- Remove any obstacles between the remote control and the frame.
- Point the remote control towards the remote sensor on the frame.
- Ensure that the battery has been installed correctly in the remote control.
- Replace the battery.

The photo frame has malfunctioned.

- Turn the photo frame off and let it rest for 30 minutes. After that, turn on the photo frame -- the restore function should reset the photo frame.
- Try updating the player's firmware. Please refer to the Firmware Upgrade section of this manual for detailed instructions.

Specifications

Display Type	7" Full-Color TFT LCD
Display Resolution	480 x 234
Memory	CF Card Slot SD/MMC Card Slot xD Card Slot MS Card Slot USB Flash Drive
Audio Format Support	MP3 (32 - 384kbps, CBR/VBR) WMA
Video Format Support	AVI (XviD) MPG MPEG
Photo Format Support	JPEG (8MB maximum)
Audio Output	3.5mm Stereo / Headphone Out Integrated Stereo Speakers
Video Output	Composite Video
Power Supply	DC 12V, 1A 100-240V AC Adapter 1 x CR2025 Battery (Remote)

Specifications and manual are subject to change without prior notice.

COBY Electronics Corp.

56-65 Rust Street
Maspeth, NY 11378

www.cobyusa.com
www.ecoby.com