

Uniden®

OWNER'S MANUAL

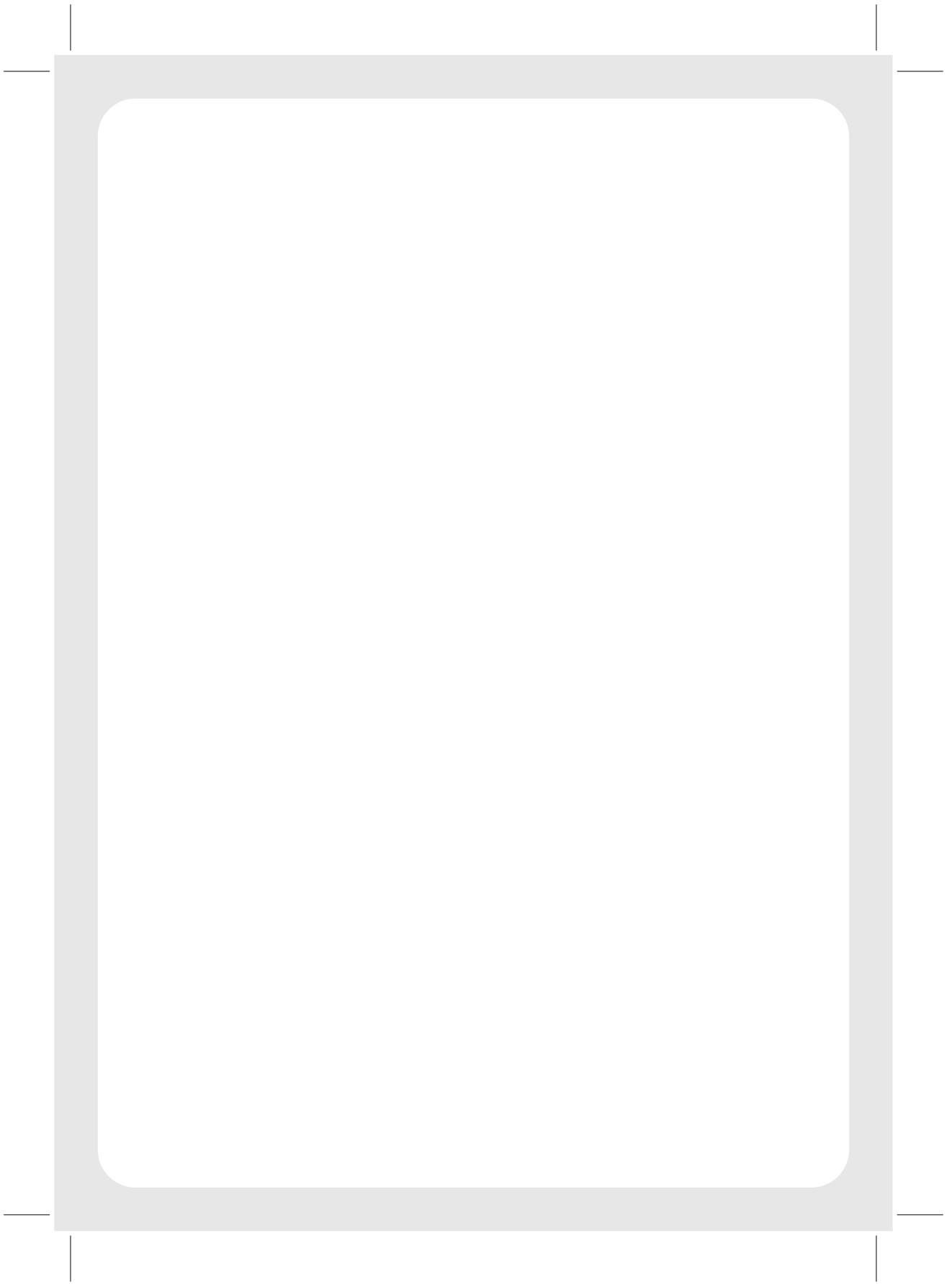

**UNIDEN uh088sx
CB RADIO**



Contents

Controls/Indicators/Connections	
Controls.....	3
Indicators.....	4
Connections.....	5
Introduction	
Features.....	6
Preventative Maintenance.....	6
Troubleshooting.....	6
Memory Backup.....	6
Layout.....	7
Included with your uh088sx CB radio.....	8
Operation	
Setting the Squelch.....	9
Selecting a Channel.....	10
Transmitting.....	10
Using Repeater Channels.....	10
Operating the uh088sx in Duplex Mode.....	11
Scanning.....	11
Open Scan (OS) Mode.....	11
Group Scan (GS) Mode.....	12
Choosing a Priority Channel.....	13
Drop Out Delay.....	13
Programming Scan Channels.....	14
Channel Seeking Operation.....	15

Contents

Continuous Tone Coded Squelch System (CTCSS).....	16
Selective Calling (Optional Selcall PCB Required)	
Outline.....	17
Selective Calling (SELCALL).....	17
Receiver Quieting (Tone Squelch).....	17
Call Alarm.....	17
Tone Squelch Scanning.....	17
Tone Calling.....	17
Group Calling Capability.....	17
Tables	
FM-CB Frequency List.....	18
CTCSS Tone List.....	18
Warranty.....	19

Controls/Indicators/Connections

uh088sx CONTROLS

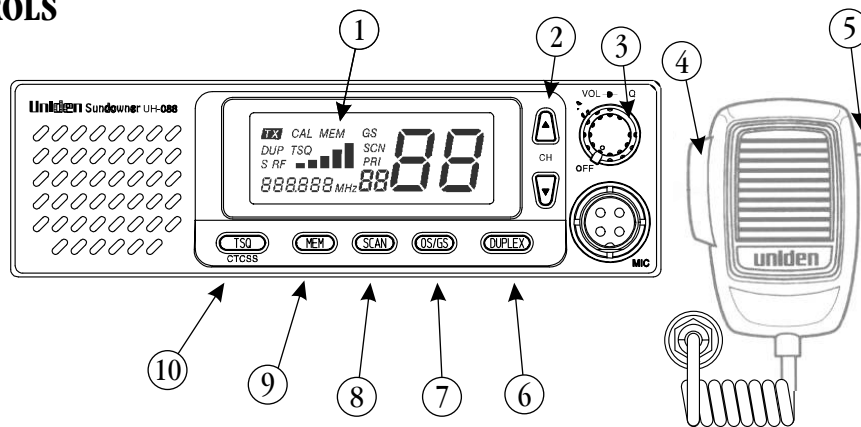

1. **LIQUID CRYSTAL DISPLAY (LCD) PANEL** - Indicators for TX, CAL, MEM, TSQ, GS (OS), SCN PRI, Channel Number, Frequency, Signal Strength Level (S), Transmit Power Level (RF), CTCSS Code and DUP.
2. **UP/DOWN CHANNEL SELECTOR** -These controls are used to select the desired communication channel.
3. **ON/OFF, VOLUME & SQUELCH CONTROLS**
ON/OFF & Volume Control (Centre Knob)
 Turns the uh088sx power ON or OFF and adjusts the volume.
Squelch Control (Outer Ring)
 Eliminates background noise in the absence of an incoming spiral.
4. **PUSH-TO-TALK (PTT) - SWITCH** - Press to transmit and release to receive.
5. **TONE CALL CONTROL BUTTON** - Press to transmit SELCALL codes, it functions on condition that SELCALL option is installed.
6. **DUPLEX Control**
 Press this button momentarily to choose semi-duplex operation for channels 1 through 8.
7. **OPEN SCAN/GROUP SCAN CONTROL (OS/GS)**- Switches operation between OPEN SCAN and GROUP SCAN Mode.
8. **SCAN CONTROL (SCAN)** - Press to activate **Normal OS/GS** scanning or press and hold to enable Seek Mode OS/GS Scanning.

Controls/Indicators/Connections

9. **MEMORY CONTROL (MEM)** - Places channel numbers into the memory scan list (OS or GS).
10. **TONE SQUELCH CONTROL (TSQ)** - Controls Tone Squelched operation (quiet Mode) on condition that SELCALL option is installed.
10 Secondary function: Continuous Tone Coded Squelch System (CTCSS) - is a feature that allows a group to talk to each other without hearing other users on the same channel.

INDICATORS

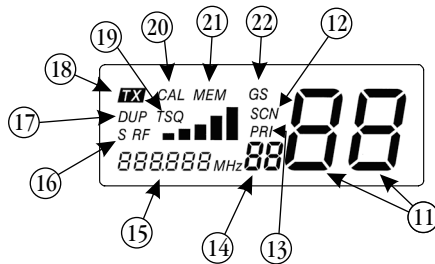

11. **Channel Indicator** - Indicates the channel number currently selected. On TX SELCALL usage the Channel Indicator becomes a Memory location indicator.
12. **Scan Indicator (SCN)** - SCN icon appears when normal Scan mode is activated. When Seek mode Scanning is selected the SCN icon blinks.
13. **Priority Indicator (PRI)** - Indicates that priority channel is active when continuously lit or flashes when it is regularly being checked for activity while GS scanning.
14. **Continuous Tone Coded Squelch System (CTCSS) Code** - Indicates the CTCSS code selected for the current channel.
15. **Frequency Indicator** - Shows the frequency of the current selected channel.
16. **RECEIVE SIGNAL/ RF LEVEL indicator (S/RF)** - Indicates the relative signal strength level when receiving (S) or the relative transmit power (RF) when transmitting.
17. **DUPLEX Indicator (DUP)** - The DUP icon appears when duplex operation is selected.
18. **TRANSMIT indicator (TX)** - TX appears when the PTT button on the microphone is pressed and the radio is transmitting. The RF icon also appears at this time.
19. **TONE SQUELCH indicator (TSQ)** - The TSQ icon will appear when the selected channel is set to operate in Quiet Mode, or flashes when the radio is called using SELCALL.
20. **CALL Indicator (CAL)** - The CAL icon appears when the uh088sx radio is called using SELCALL. It also appears when SELCALL codes are being transmitted.
21. **MEMORY Indicator (MEM)** - MEM appears when the displayed channel is programmed either in GS or OS Memory.
22. **GROUP SCAN Indicator (GS)** - The GS icon appears when Group Scan Mode is activated. Open scan is indicated by the absence of the GS icon.

Controls/Indicators/Connections

CONNECTIONS

FRONT PANEL

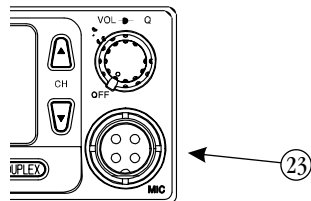

23. MICROPHONE SOCKET

The microphone plug is inserted into this socket.

BACK PANEL

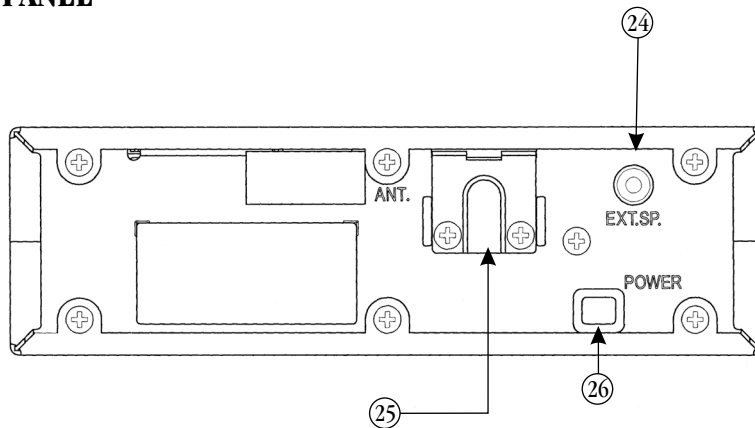

24. EXTERNAL SPEAKER JACK - used for remote receiver monitoring. When the external speaker is connected, the internal speaker is automatically disconnected. The connecting wire must use a 3.5mm miniature plug only.

25. ANTENNA CONNECTOR - Connect the Antenna here using a standard UHF (PL259) type connector.

26. DC POWER CORD - DC Power is connected to the transceiver through this jack. A power cord is supplied with the transceiver.

Introduction

The Uniden uh088sx is designed to provide you with years of trouble free service. It's rugged components and materials are capable of withstanding harsh environments.

We are certain that you will enjoy your uh088sx. Please read this operating Manual carefully to ensure you gain the optimum performance of the unit.

Features

- Transmit & Receive FM 40CH (UHF - CB, TX Power 5w)
- 7 Segments LCD
- CTCSS function
- Tone Squelch (Selcall) Capability
- Duplex Capability (from CH01 - CH08 per channel)
- Open Scan/Group Scan
- Variable Squelch Level adjust
- Volume Control with power ON/Off Switch

Preventative Maintenance

The following system checks should be made every six to twelve months:

- Check the standing Wave Ratio (SWR)
- Inspect the tightness of all electrical connections.
- Inspect the antenna coaxial cable for wear or breaks on the shielding.
- Inspect the tightness of all screws and all other mounting hardware.

Troubleshooting

Should the unit malfunction or perform poorly, follow these procedures:

- Check the power cord and fuse.

If there is trouble with receiving...

- Check the VOLUME control setting. Be sure the SQUELCH is adjusted properly. Possibly the radio is over squelched.

If there is trouble with transmitting...

- Check that the transmission line (coaxial cable) is securely connected to the ANTENNA connector.
- Check that the antenna is fully extended for proper operation.
- Check that all transmission line (coaxial cable) connections are secure and free of corrosion.

Memory Backup

A built in EEPROM protects the channels stored in the uh088sx memory after the DC power cable is disconnected

Introduction

LAYOUT

Front Panel Layout

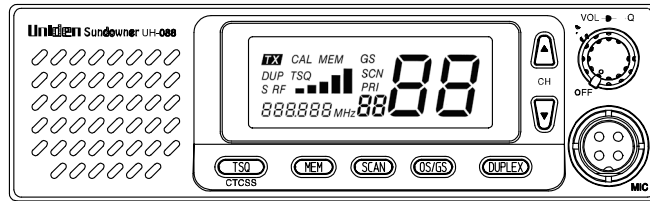

Microphone Layout

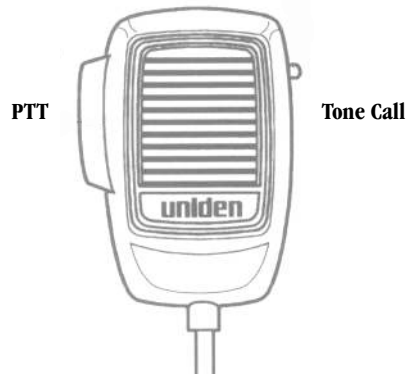

Included with your uh088sx CB radio



uh088sx Owners Manual

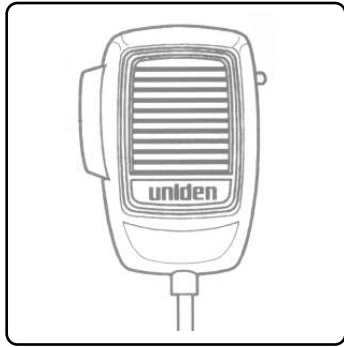

Microphone

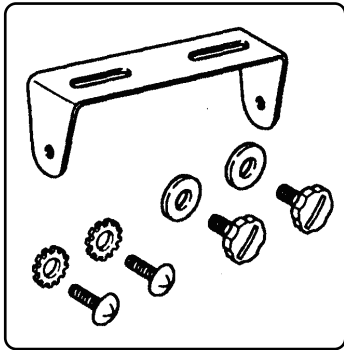

Mounting Bracket, Knobs,
Rubber washer, Washer Stars
and Screws.

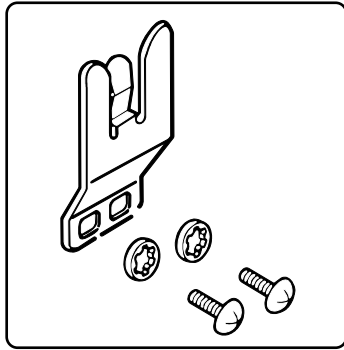

Microphone Hanger Screws
and washers

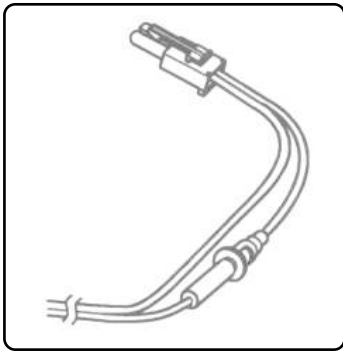

DC Power Cord with fuse

Operation

Setting the Squelch

1. To turn the unit ON, rotate volume clockwise. Adjust volume to a comfortable level.



You must select a channel which is not in use before setting the SQUELCH control. (see p.10)

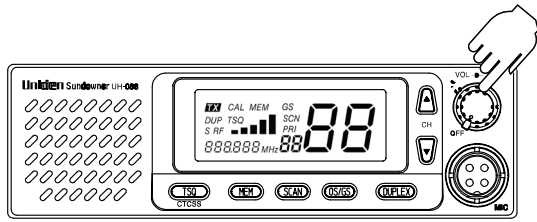

2. Think of the Squelch control as a gate. If you turn SQUELCH fully clockwise it raises the "Squelch Gate" so that no signals get through.

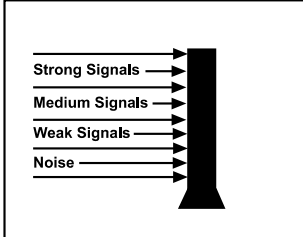

3. If you turn the SQUELCH fully counter clockwise, it lowers the "Squelch Gate" so that everything gets through - noise, weak signals and strong signals.

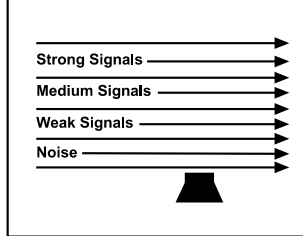

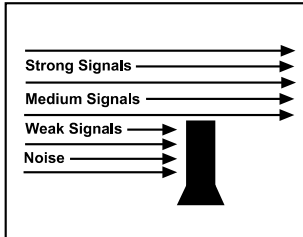

4. To set the "Squelch Gate" to the desired level, turn SQUELCH counterclockwise until you hear noise. Then turn the SQUELCH clockwise just until the noise stops. Now only strong signals get through.



Operation

SELECTING A CHANNEL

Press  or  button to select a channel

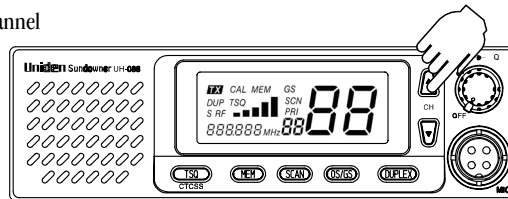

TRANSMITTING

Select the desired channel. Press the Microphone's PTT button, hold it approx 7cm from your mouth and speak normally into the microphone. The **TX** icon will light. Release the PTT button to end the transmission and listen for a reply.

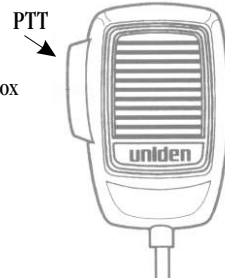

USING REPEATER CHANNELS

UHF CB Repeaters are used to retransmit or relay your signal. Repeaters will extend the range of your radio and overcome the shielding effect caused by solid obstructions. In normal Simplex operation, your radio transmits on one particular frequency and receives on that same frequency. If there is a barrier that partially blocks your transmitted signal, the probability of another radio receiving the signal is very slim. Hills, tall buildings, metallic structures, ... etc. tend to act as a screen between radios.

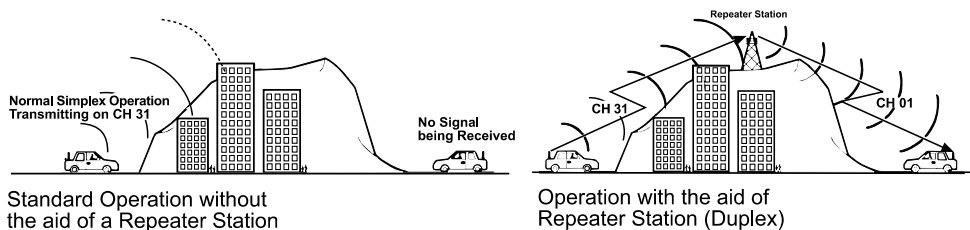

The Signal coming from your radio is received by the Repeater Station and then retransmitted at the same time on another channel. This operation is called "Duplexing".

For example,

CH01 on Duplex Mode will Receive on CH 01 but Transmit on CH31

CH02 on Duplex Mode will Receive on CH 02 but Transmit on CH32 etc

If you transmit on CH01 Duplex mode, you are actually transmitting on CH31, the repeater station down-converts your signal and retransmits on CH01.

Operation

Operating the uh088sx in Duplex Mode

For this example we are adopting CH01 as the channel being used in your area for repeater use. Press **(DUPLX)** to switch Duplex On. The duplex icon DUP appears. If Duplex is not required - press again to switch Duplex off. Only channels 01 - 08 are available for Duplex

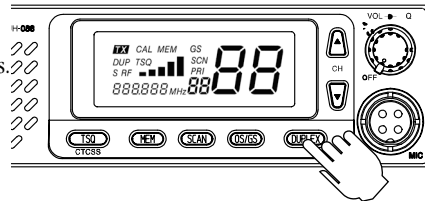

Check with your local Retailer to determine if there is a Repeater in your area.

Scanning

The uh088sx has a scanning feature that allows you to search for active channels automatically. Furthermore, the uh088sx is designed to have two types of scanning; Open Scanning (OS) and Group Scanning (GS), to give you flexibility and allow you to use the radio more effectively. Press **(SCAN)** and scanning starts. The scan icon SCN appears.

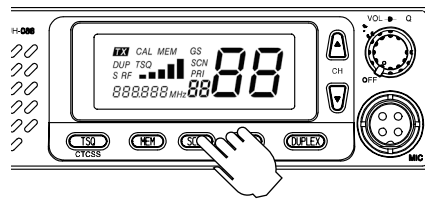

Open Scan (OS) Mode

Allows continuous scanning of channels stored in the Open Scan memory. If an active channel is found, scanning will stop on that channel.

This example shows CH40 active.

If the received signal ceases, the unit will wait 3 seconds for the signal to return, otherwise scanning resumes.

To skip the active channel, press **(MEM)** momentarily. Scanning resumes.

To deactivate scan, press **(SCAN)** while scanning or the PTT button on the microphone.



If SCAN is deactivated while on an active channel, the uh088sx will stay on that active channel. If no channels are active, the uh088sx will reinstate the starting channel.

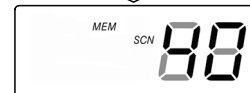

Operation

Group Scan (GS) Mode

Allows you to monitor a priority channel while scanning.

To use GS Mode Scanning, press the **(OS/GS)** key.
GS icon appears on the display. OS Mode is indicated by the absence of the GS icon.

GS Scanning checks the priority channel activity regularly.

If the Priority channel becomes active the radio will stay on that channel for as long as the signal is active.
If the received signal ceases, the unit will wait 3 seconds for the signal to return, otherwise scanning resumes.

If scanning stops on a channel which is not a Priority channel, uh088sx will continue monitoring the priority channel for activity while listening to the active one.

eg CH40 becomes active.

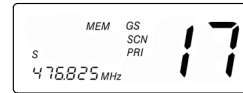
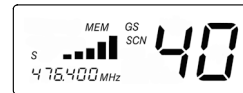
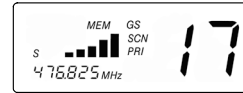
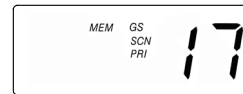

If SCAN is deactivated while it is turned to an active channel, the ub088sx will stay on that active channel. If none of the channels are active, the ub088sx will reinstate the starting channel.



If GS is initiated when there are no channels programmed in GS memory, an error tone will be heard and scanning will not start (see programming Scan Channels - below).

Operation

Choosing a Priority Channel

The starting channel, when Group Scanning is initiated, is always the priority channel.

Changing the PRI channel setting while scanning

eg: PRI Channel is CH17 (476.825 Mhz)

- a. press , to select a higher channel (scanning pauses)

- or -

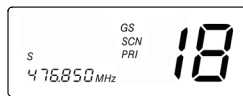

- b. press , to select a lower channel

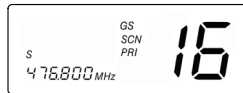

Drop-out delay

While scanning, the uh088sx stops at a busy channel and receives a transmission. When the received signal is over, the unit will wait for three seconds for the return of the signal, otherwise, the radio resumes scanning.

Operation

Programming Scan Channels

1. Select which Scanning Mode you wish to use on the channel.
OS or GS Mode

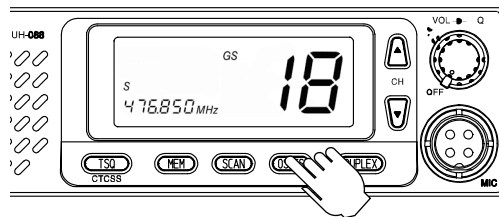

2. Select the channel you want to store.



3. Press and hold **MEM** for 1.5sec. to store.
MEM icon appears and a short tone beep is heard.

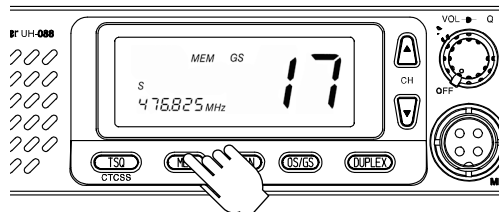

4. To remove the channel from memory, press and hold **MEM** for 1.5 sec. once more.
Two successive beeps are heard and the **MEM** icon disappears.

Operation

Channel Seeking Operation

Unlike normal scanning, CHANNEL SEEK is used more often when checking for active channels.

If a signal is detected, while seeking, the uh088sx will tune to that signal for 4 seconds only and the resumes Seeking Operation.

Changing from SCAN to SEEK Mode Operation.

- 1 Firstly, activate scan mode by pressing 



2. Press and hold  until a 'beep' is heard. The SCN icon starts to flash.

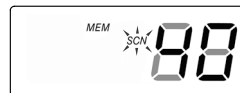

3. If an active channel is detected the uh088sx will stop on that channel for 4 seconds. (eg CH17)

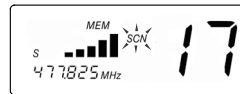

4. After 4 seconds, the uh088sx will start seeking again for active channels.



5. If you find the channel interesting, simply press either the PTT switch or  to stop the operation before the 4 second timer elapses.

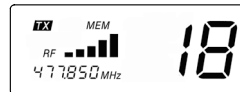

When  is pressed again SEEK is still the mode of operation.



To change back to SCAN, while SEEKING, press and hold  until a beep is heard. The SCN icon stops flashing.





SEEK checks the same channel stored in SCAN memory. Thus, you can Seek either in OS or GS Mode.



Operation

Continuous Tone Coded Squelch System (CTCSS)

This feature allows signals to be received only from callers who have selected the same CTCSS code.

Press  or  to select the desired channel to use CTCSS.

Press and hold  for 2 seconds. **CTCSS** code flashes.

Press  or  to select the desired CTCSS code 01 - 38.

Press  once to store the new setting.

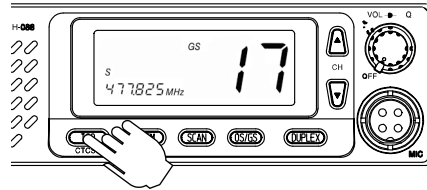

To turn CTCSS OFF please follow the above steps but select the desired CTCSS code of (before code 01).



*Channels 05 and 35 are Emergency Channels.
CTCSS cannot be selected on these channels.*



*If a button is not pressed within 10
seconds the ub088sx will automatically
exit Select Mode.*

Selective Calling (Optional Selcall PCB Required)

Outline

Selective Calling (SELCALL) is a special Sequential Tone Squelch System that allows the user to receive/transmit calls selectively from/to an individual or group, on a shared busy channel.

The uh088sx has an **Optional Selective Calling system**.

Exceptional features, like Receiver Quieting, Tone Squelch Scanning, Tone and Group Calling make the uh088sx superior to any transceivers in its class.

Receiver Quieting (Tone Squelch)

When activated, it automatically mutes the receiver audio circuit of the radio.

It will stay in this 'Quiet' mode as long as the SELCALL tone code (SELCALL ID) required to open the muting circuit is not received.

Call Alarm

When a received code matches to your SELCALL ID, an alarm (CA Alert) will be emitted informing you that a caller is on the channel.

Tone Squelch Scanning

Scans only tone squelched Channels.

Tone Calling

Allows you to selectively call another radio.

Group Calling Capability

Transmits and Responds to Group Calls.

Tables

FM - CB Frequency List - Australia & New Zealand

CH No.	Simplex Mode Transmit / Receive Frequency (MHz)	Duplex Mode Transmit Frequency (MHz)	CH No.	Simplex Mode Transmit / Receive Frequency (MHz)
01	476.425	477.175 CH31	21	476.925
02	476.450	477.200 CH32	22	476.950
03	476.475	477.225 CH33	23	476.975
04	476.500	477.250 CH34	24	477.000
05	476.525	477.275 CH35	25	477.025
06	476.550	477.300 CH36	26	477.050
07	476.575	477.325 CH37	27	477.075
08	476.600	477.350 CH38	28	477.100
09	476.625		29	477.125
10	476.650		30	477.150
11	476.675		31	477.175
12	476.700		32	477.200
13	476.725		33	477.225
14	476.750		34	477.250
15	476.775		35	477.275
16	476.800		36	477.300
17	476.825		37	477.325
18	476.850		38	477.350
19	476.875		39	477.375
20	476.900		40	477.400

Note: Channel 05 and 35 are Emergency Channels and Channel 11 is a calling channel

CTCSS TONE List

Tone No.	Tone Frequency (Hz)	Tone No.	Tone Frequency (Hz)	Tone No.	Tone Frequency (Hz)
00 (OFF)	OFF	13	103.5	26	162.2
01	67.0	14	107.2	27	167.9
02	71.9	15	110.9	28	173.8
03	74.4	16	114.8	29	179.9
04	77.0	17	118.8	30	186.2
05	79.7	18	123.0	31	192.8
06	82.5	19	127.3	32	203.5
07	85.4	20	131.8	33	210.7
08	88.5	21	136.5	34	218.1
09	91.5	22	141.3	35	225.7
10	94.8	23	146.2	36	233.6
11	97.4	24	151.4	37	241.8
12	100.0	25	156.7	38	250.3

NOTE: Channel 05 and 35 are not CTCSS programmable

Warranty

ONE YEAR LIMITED WARRANTY

IMPORTANT: Evidence of the original purchase is required for warranty service.

WARRANTOR: Uniden New Zealand Limited. Uniden Australia Pty Ltd. ACN 001 865 498

ELEMENTS OF WARRANTY: Uniden warrants to the original retail owner for the duration of this warranty its uh088sx (hereinafter referred to as the Product), to be free from defects in materials and craftsmanship with only the limitations or exclusions set out below.

WARRANTY DURATION: This warranty to the original retail owner only is only valid in the original country of purchase and shall be of no further effect 12 months after the date of original retail sale. This warranty will be deemed invalid if the Product is: (A) Damaged or not maintained as reasonable and necessary, (B) Modified, altered or used as part of any conversion kits, subassemblies, or any configurations not sold by Uniden, (C) Improperly installed, (D) Repaired by someone other than an authorised Uniden Repair Agent for a defect or malfunction covered by this warranty, (E) Used in conjunction with any equipment or parts or as a part of a system not manufactured by Uniden. (F) Only available in the original country of sale.

PARTS COVERED: This warranty covers for one (1) year, the uh088sx transceiver only. All accessories (Mounting bracket, Microphone etc.) are covered for 90 days only.

STATEMENT OF REMEDY: In the event that the Product does not conform to this warranty at any time while this warranty is in effect, the warrantor, at its discretion, will repair the defect or replace the Product and return it to you without charge for parts and service. **THIS WARRANTY DOES NOT COVER OR PROVIDE FOR THE REIMBURSEMENT OR PAYMENT OF INCIDENTAL OR CONSEQUENTIAL DAMAGES. THIS GUARANTEE IS IN ADDITION TO AND DOES NOT IN ANY WAY AFFECT YOUR RIGHTS UNDER THE CONSUMER GUARANTEE ACT.**

PROCEDURE FOR OBTAINING PERFORMANCE OF WARRANTY: in the event that the Product does not conform to this warranty, the Product should be shipped or delivered, freight prepaid, with evidence of original purchase (e.g. a copy of the sales docket) to the warrantor at:

**UNIDEN AUSTRALIA PTY LIMITED
SERVICE DIVISION**

345 Princes Highway,
Rockdale,
NSW 2216,
AUSTRALIA
Fax: (02) 9599 3278
www.uniden.com.au

**UNIDEN NEW ZEALAND LIMITED
SERVICE DIVISION**

150 Harris Road,
East Tamaki,
Auckland,
NEW ZEALAND
Fax: (09) 274 4253
www.uniden.co.nz

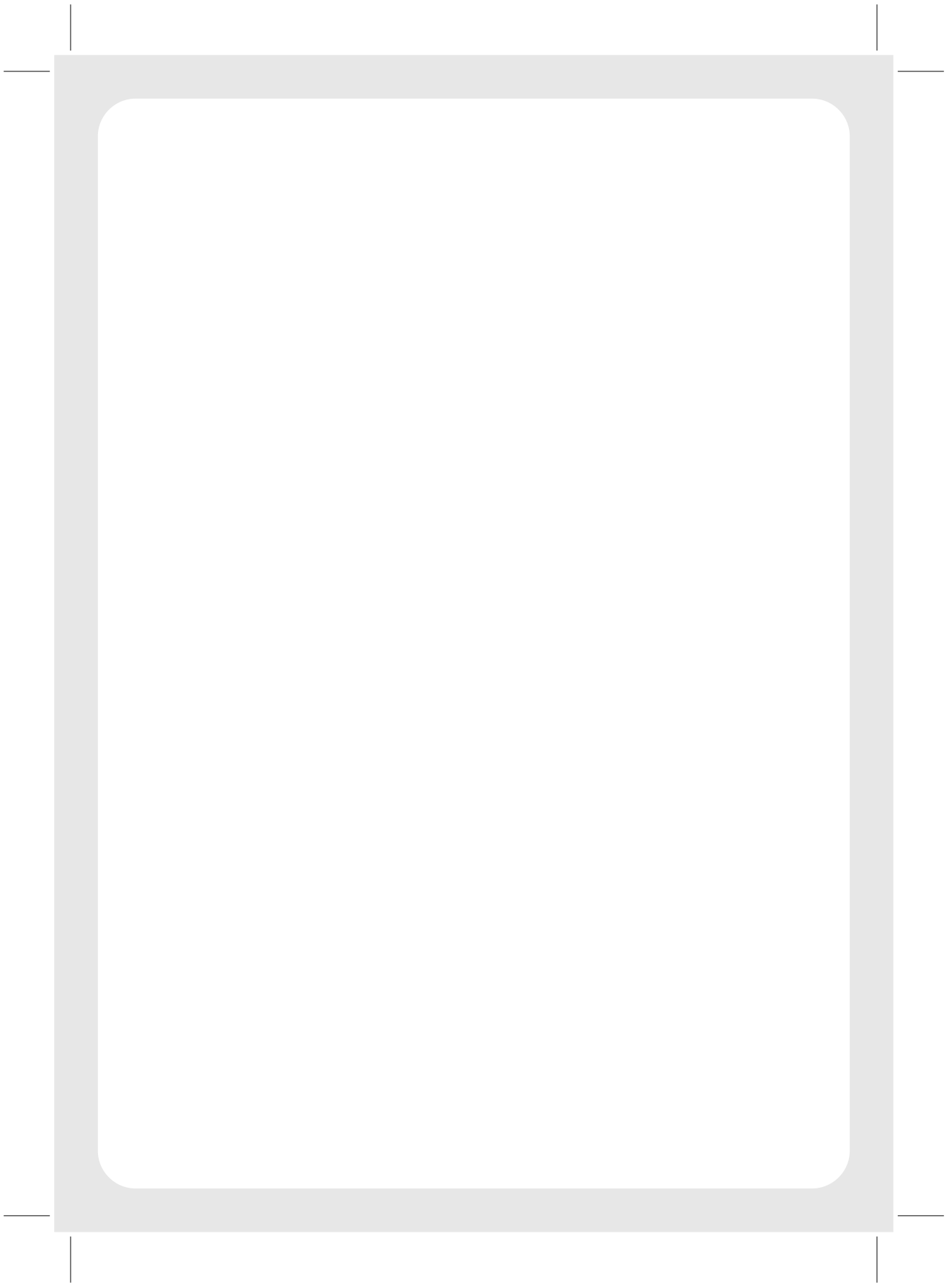



Uniden[®]

© 2004 Uniden Australia Pty Limited / Uniden New Zealand Limited
Printed in the in China
UTZZ01924ZZ