

12" Portable Planer

(Model 22-540)

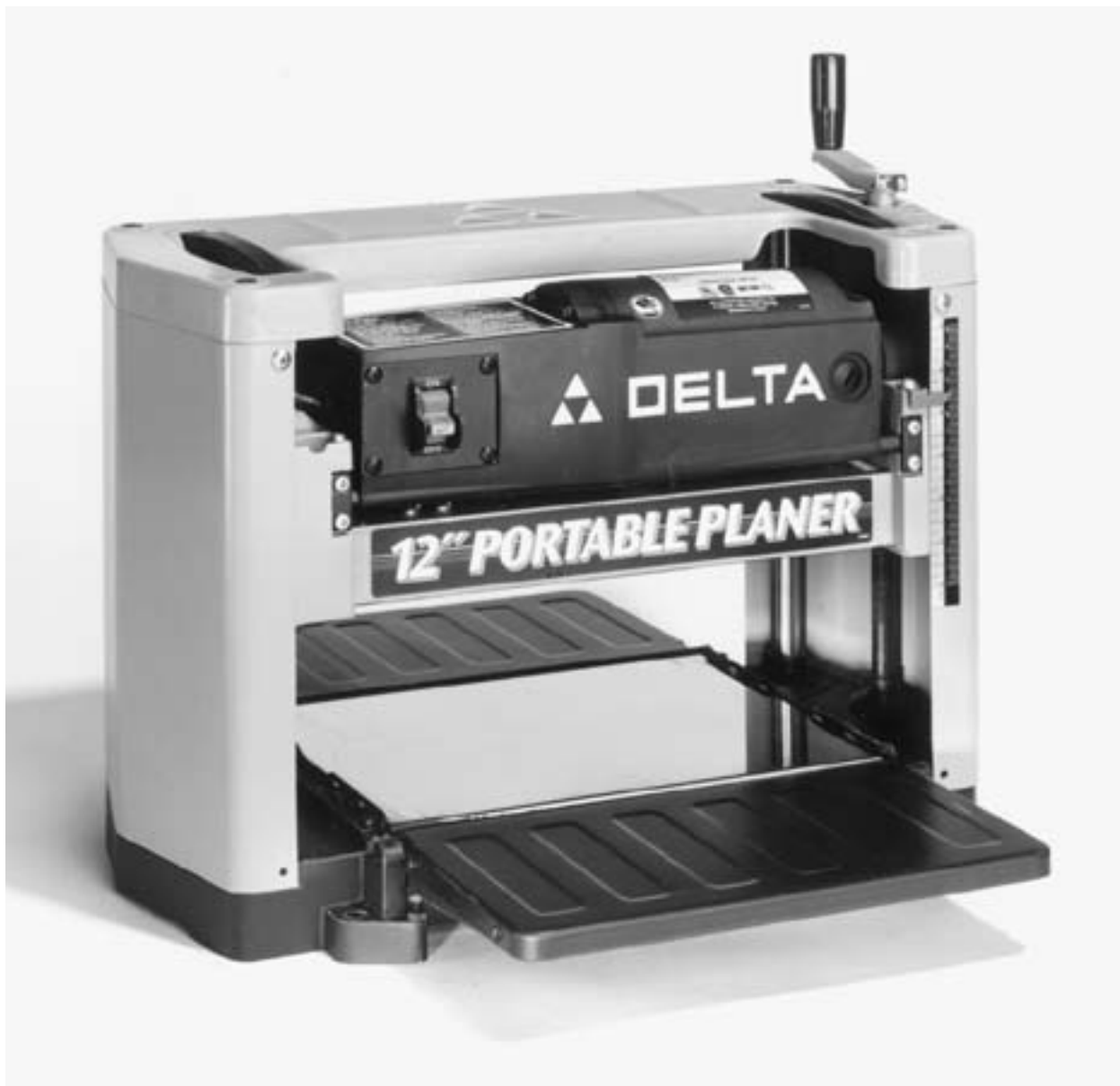

PART NO. 901606 (013)
Copyright © 2001 Delta Machinery



To learn more about DELTA MACHINERY
visit our website at: www.deltamachinery.com.

For Parts, Service, Warranty or other Assistance,

please call **1-800-223-7278** (In Canada call **1-800-463-3582**).

ESPAÑOL: PÁGINA 17

SAFETY RULES

Woodworking can be dangerous if safe and proper operating procedures are not followed. As with all machinery, there are certain hazards involved with the operation of the product. Using the machine with respect and caution will considerably lessen the possibility of personal injury. However, if normal safety precautions are overlooked or ignored, personal injury to the operator may result. Safety equipment such as guards, push sticks, hold-downs, featherboards, goggles, dust masks and hearing protection can reduce your potential for injury. But even the best guard won't make up for poor judgment, carelessness or inattention. Always use common sense and exercise caution in the workshop. If a procedure feels dangerous, don't try it. Figure out an alternative procedure that feels safer. **REMEMBER:** Your personal safety is your responsibility.

This machine was designed for certain applications only. Delta Machinery strongly recommends that this machine not be modified and/or used for any application other than that for which it was designed. If you have any questions relative to a particular application, **DO NOT** use the machine until you have first contacted Delta to determine if it can or should be performed on the product.

**Technical Service Manager
Delta Machinery
4825 Highway 45 North
Jackson, TN 38305**

(IN CANADA: 505 SOUTHGATE DRIVE, GUELPH, ONTARIO N1H 6M7)



WARNING: FAILURE TO FOLLOW THESE RULES MAY RESULT IN SERIOUS PERSONAL INJURY

1. FOR YOUR OWN SAFETY, READ INSTRUCTION MANUAL BEFORE OPERATING THE TOOL. Learn the tool's application and limitations as well as the specific hazards peculiar to it.

2. KEEP GUARDS IN PLACE and in working order.

3. ALWAYS WEAR EYE PROTECTION.

4. REMOVE ADJUSTING KEYS AND WRENCHES. Form habit of checking to see that keys and adjusting wrenches are removed from tool before turning it "on".

5. KEEP WORK AREA CLEAN. Cluttered areas and benches invite accidents.

6. DON'T USE IN DANGEROUS ENVIRONMENT. Don't use power tools in damp or wet locations, or expose them to rain. Keep work area well-lighted.

7. KEEP CHILDREN AND VISITORS AWAY. All children and visitors should be kept a safe distance from work area.

8. MAKE WORKSHOP CHILDPROOF – with padlocks, master switches, or by removing starter keys.

9. DON'T FORCE TOOL. It will do the job better and be safer at the rate for which it was designed.

10. USE RIGHT TOOL. Don't force tool or attachment to do a job for which it was not designed.

11. WEAR PROPER APPAREL. No loose clothing, gloves, neckties, rings, bracelets, or other jewelry to get caught in moving parts. Non-slip footwear is recommended. Wear protective hair covering to contain long hair.

12. ALWAYS USE SAFETY GLASSES. Wear safety glasses. Everyday eyeglasses only have impact resistant lenses; they are not safety glasses. Also use face or dust mask if cutting operation is dusty. These safety glasses must conform to ANSI Z87.1 requirements. Note: Approved glasses have Z87 printed or stamped on them.

13. SECURE WORK. Use clamps or a vise to hold work when practical. It's safer than using your hand and frees both hands to operate tool.

14. DON'T OVERREACH. Keep proper footing and balance at all times.

15. MAINTAIN TOOLS IN TOP CONDITION. Keep tools sharp and clean for best and safest performance. Follow instructions for lubricating and changing accessories.

16. DISCONNECT TOOLS before servicing and when changing accessories such as blades, bits, cutters, etc.

17. USE RECOMMENDED ACCESSORIES. The use of accessories and attachments not recommended by Delta may cause hazards or risk of injury to persons.

18. REDUCE THE RISK OF UNINTENTIONAL STARTING. Make sure switch is in "OFF" position before plugging in power cord.

19. NEVER STAND ON TOOL. Serious injury could occur if the tool is tipped or if the cutting tool is accidentally contacted.

20. CHECK DAMAGED PARTS. Before further use of the tool, a guard or other part that is damaged should be carefully checked to ensure that it will operate properly and perform its intended function – check for alignment of moving parts, binding of moving parts, breakage of parts, mounting, and any other conditions that may affect its operation. A guard or other part that is damaged should be properly repaired or replaced.

21. DIRECTION OF FEED. Feed work into a blade or cutter against the direction of rotation of the blade or cutter only.

22. NEVER LEAVE TOOL RUNNING UNATTENDED. TURN POWER OFF. Don't leave tool until it comes to a complete stop.

23. DRUGS, ALCOHOL, MEDICATION. Do not operate tool while under the influence of drugs, alcohol or any medication.

24. MAKE SURE TOOL IS DISCONNECTED FROM POWER SUPPLY while motor is being mounted, connected or re-connected.

25. THE DUST GENERATED by certain woods and wood products can be injurious to your health. Always operate machinery in well ventilated areas and provide for proper dust removal. Use wood dust collection systems whenever possible.

26. ⚠ WARNING: SOME DUST CREATED BY POWER SANDING, SAWING, GRINDING, DRILLING, AND OTHER CONSTRUCTION ACTIVITIES contains chemicals known to cause cancer, birth defects or other reproductive harm. Some examples of these chemicals are:

- lead from lead-based paints,
- crystalline silica from bricks and cement and other masonry products, and
- arsenic and chromium from chemically-treated lumber.

Your risk from these exposures varies, depending on how often you do this type of work. To reduce your exposure to these chemicals: work in a well ventilated area, and work with approved safety equipment, such as those dust masks that are specially designed to filter out microscopic particles.

SAVE THESE INSTRUCTIONS. Refer to them frequently and use them to instruct other users.

ADDITIONAL SAFETY RULES FOR PLANERS

1. **DO NOT** operate the tool until it is completely assembled and installed according to the instructions.
2. **IF YOU ARE NOT** thoroughly familiar with the operation of planers, obtain advice from your supervisor, instructor or other qualified person.
3. **MAKE SURE** wiring codes and recommended electrical connection instructions are followed, and that the machine is properly grounded.
4. **MAKE** all adjustments with the power off.
5. **DISCONNECT** machine from power source when making repairs.
6. **NEVER** turn the planer "ON" before clearing the table of all objects (tools, scraps of wood, etc.).
7. **KEEP** knives sharp and free of all rust and pitch.
8. **NEVER** perform any planing operation with guard removed.
9. **KEEP** fingers and hands away from cutting area.
10. **NEVER** reach under the cutterhead while the machine is running.
11. **KEEP** fingers and hands away from chip exhaust opening. The cutterhead rotates at extremely high speeds.
12. **NEVER** feed the work into the outfeed end of machine.
13. **ADEQUATELY** support the workpiece at all times.
14. **WHEN** planing extra long workpieces, **MAKE SURE** the material is supported at the infeed and outfeed end at table height.
15. **NEVER** start the machine with the workpiece in contact with the cutterhead.
16. **MAKE SURE** the workpiece is free from nails and other foreign objects which could cause injury or damage to the blades.
17. **MAKE SURE** the blades are properly secured in the cutterhead, as explained in the instruction manual, before turning on power.
18. **ALWAYS** allow the cutterhead to reach full speed before using.
19. **IF DURING OPERATION** there is any tendency for the tool to tip over, slide or walk on the supporting surface, **MAKE SURE TOOL IS SECURED TO THE SUPPORTING SURFACE.**
20. **DO NOT** perform planing operations on material shorter than 10 inches, narrower than 3/4 inches, wider than 12 inches, or thinner than 3/16 inches.
21. **BEFORE LEAVING** the machine, make sure the work area is clean.
22. **SHOULD** any part of your planer be missing, damaged or fail in any way, or any electrical component fail to perform properly, shut off switch and remove plug from power supply outlet. Replace missing, damaged or failed parts before resuming operation.
23. **IMPORTANT: When the tool is not in use, the switch should be locked in the "OFF" position to prevent unauthorized use.**
24. **ADDITIONAL INFORMATION** regarding the safe and proper operation of this product is available from the National Safety Council, 1121 Spring Lake Drive, Itasca, IL 60143-3201 in the Accident Prevention Manual for Industrial Operation and also in the Safety Data Sheets provided by the NSC. Please also refer to the American National Standards Institute ANSI O1.1 Safety Requirements for Woodworking Machinery and the U.S. Department of Labor OSHA 1910.213 Regulations.

CONNECTING TOOL TO POWER SOURCE

POWER CONNECTIONS

A separate electrical circuit should be used for your tools. This circuit should not be less than #12 wire and should be protected with a 20 Amp time lag fuse. If an extension cord is used, use only 3-wire extension cords which have 3-prong grounding type plugs and 3-hole receptacles which accept the tool's plug. Before connecting the motor to the power line, make sure the switch is in the "OFF" position and be sure that the electric current is of the same characteristics as indicated on the tool. All line connections should make good contact. Running on low voltage will damage the motor.

MOTOR SPECIFICATIONS

Your tool is wired for 120 volt, 60 HZ alternating current. Before connecting the tool to the power source, make sure the switch is in the "OFF" position. The no-load speed of the motor is 8000 RPM.

GROUNDING INSTRUCTIONS



WARNING: THIS TOOL MUST BE GROUNDED WHILE IN USE TO PROTECT THE OPERATOR FROM ELECTRIC SHOCK.

1. All grounded, cord-connected tools: In the event of a malfunction or breakdown, grounding provides a path of least resistance for electric current to reduce the risk of electric shock. This tool is equipped with an electric cord having an equipment-grounding conductor and a grounding plug. The plug must be plugged into a matching outlet that is properly installed and grounded in accordance with all local codes and ordinances.

Do not modify the plug provided - if it will not fit the outlet, have the proper outlet installed by a qualified electrician.

Improper connection of the equipment-grounding conductor can result in risk of electric shock. The conductor with insulation having an outer surface that is green with or without yellow stripes is the equipment-grounding conductor. If repair or replacement of the electric cord or plug is necessary, do not connect the equipment-grounding conductor to a live terminal.

Check with a qualified electrician or service personnel if the grounding instructions are not completely understood, or if in doubt as to whether the tool is properly grounded.

Use only 3-wire extension cords that have 3-prong grounding type plugs and 3-hole receptacles that accept the tool's plug, as shown in Fig. AA.

Repair or replace damaged or worn cord immediately.

2. Grounded, cord-connected tools intended for use on a supply circuit having a nominal rating less than 150 volts:

This tool is intended for use on a circuit that has an outlet that looks like the one illustrated in Fig. AA. The tool has a grounding plug that looks like the plug illustrated in Fig. AA. A temporary adapter, which looks like the adapter illustrated in Fig. BB, may be used to connect this plug a 2-hole receptacle as shown in Fig. BB if a properly grounded outlet is not available. The temporary adapter should be used only until a properly grounded outlet can be installed by a qualified electrician. The green-colored rigid ear, lug, and the like, extending from the adapter must be connected to a permanent ground such as a properly grounded outlet box. Whenever the adapter is used, it must be held in place with a metal screw.

NOTE: In Canada, the use of a temporary adapter is not permitted by the Canadian Electric Code.



WARNING: IN ALL CASES, MAKE CERTAIN RECEPTACLE IN QUESTION IS PROPERLY GROUNDED. IF YOU ARE NOT SURE HAVE A QUALIFIED ELECTRICIAN CHECK THE RECEPTACLE.

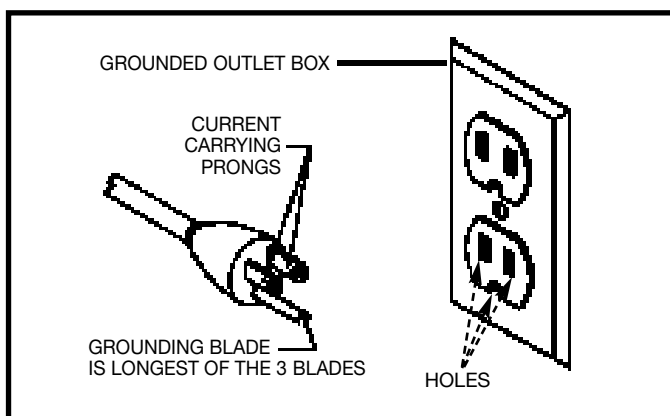

Fig. AA

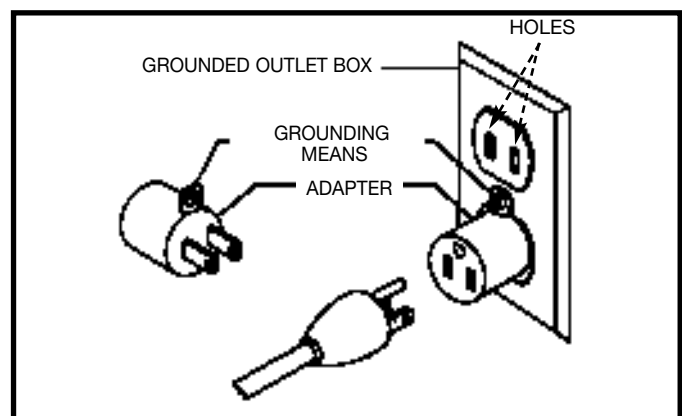

Fig. BB

EXTENSION CORDS

Use proper extension cords. Make sure your extension cord is in good condition and is a 3-wire extension cord which has a 3-prong grounding type plug and a 3-hole receptacle which will accept the tool's plug. When using an extension cord, be sure to use one heavy enough to carry the current of the saw. An undersized cord will cause a drop in line voltage, resulting in loss of power and overheating. Fig. DD, shows the correct gauge to use depending on the cord length. If in doubt, use the next heavier gauge. The smaller the gauge number, the heavier the cord.

MINIMUM GAUGE EXTENSION CORD			
RECOMMENDED SIZES FOR USE WITH STATIONARY ELECTRIC TOOLS			
Ampere Rating	Volts	Total Length of Cord in Feet	Gauge of Extension Cord
0-6	120	up to 25	18 AWG
0-6	120	25-50	16 AWG
0-6	120	50-100	16 AWG
0-6	120	100-150	14 AWG
6-10	120	up to 25	18 AWG
6-10	120	25-50	16 AWG
6-10	120	50-100	14 AWG
6-10	120	100-150	12 AWG
10-12	120	up to 25	16 AWG
10-12	120	25-50	16 AWG
10-12	120	50-100	14 AWG
10-12	120	100-150	12 AWG
12-16	120	up to 25	14 AWG
12-16	120	25-50	12 AWG
12-16	120	<i>GREATER THAN 50 FEET NOT RECOMMENDED</i>	

Fig. DD

MINIMUM GAUGE EXTENSION CORD			
RECOMMENDED SIZES FOR USE WITH STATIONARY ELECTRIC TOOLS			
Ampere Rating	Volts	Total Length of Cord in Feet	Gauge of Extension Cord
0-6	240	up to 50	18 AWG
0-6	240	50-100	16 AWG
0-6	240	100-200	16 AWG
0-6	240	200-300	14 AWG
6-10	240	up to 50	18 AWG
6-10	240	50-100	16 AWG
6-10	240	100-200	14 AWG
6-10	240	200-300	12 AWG
10-12	240	up to 50	16 AWG
10-12	240	50-100	16 AWG
10-12	240	100-200	14 AWG
10-12	240	200-300	12 AWG
12-16	240	up to 50	14 AWG
12-16	240	50-100	12 AWG
12-16	240	<i>GREATER THAN 100 FEET NOT RECOMMENDED</i>	

Fig. DD

OPERATING INSTRUCTIONS

FOREWORD

Delta Model 22-540 is a 12" (305mm) Portable Planer with adjustable feed rate for optimum planing under load. It has the following cutting capacity; 12" (305mm) width , 6" (152mm) thickness and 3/16" (5mm) depth of cut. Features include; basic machine with powerful 15 amp, 120 volt motor, dust chute, two-knife cutterhead with an extra set of high-speed steel, double-edged reversible knives; knife-setting gage and wrench, polyurethane feed rolls and adjustable-folding table extensions.

UNPACKING AND CLEANING

Carefully unpack the tool and all loose items from the shipping container(s). Peel protective film from the table surface. Remove and clean the protective coating from the cutterhead. Remove the protective coating from all unpainted surfaces. This coating may be removed with a soft cloth moistened with kerosene (do not use acetone, gasoline or lacquer thinner for this purpose). After cleaning, cover the unpainted surfaces with a good quality paste wax.

CAUTION: CARE MUST BE TAKEN WHEN CLEANING THE CUTTERHEAD AS THE KNIVES ARE SHIPPED IN THE CUTTERHEAD AND THEY ARE VERY SHARP. Figs. 2 and 3, ILLUSTRATE THE PLANER AND ALL LOOSE ITEMS SUPPLIED WITH THE MACHINE.

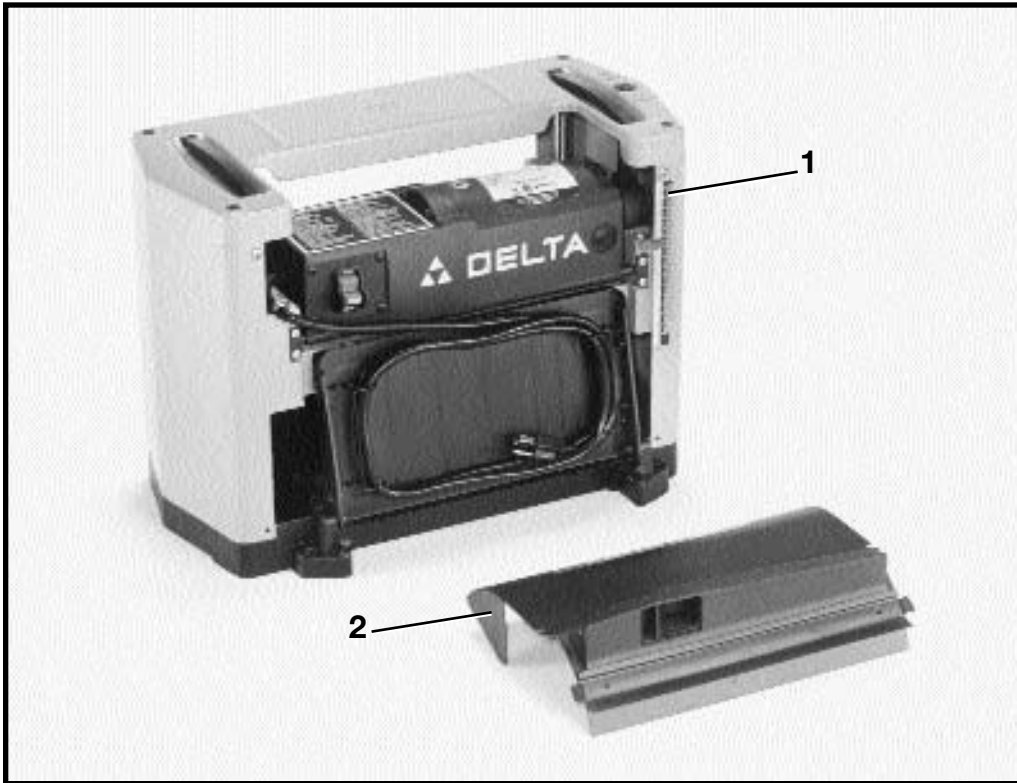

Fig. 2

- 1 - 12 Planer
- 2 - Chip Deflector

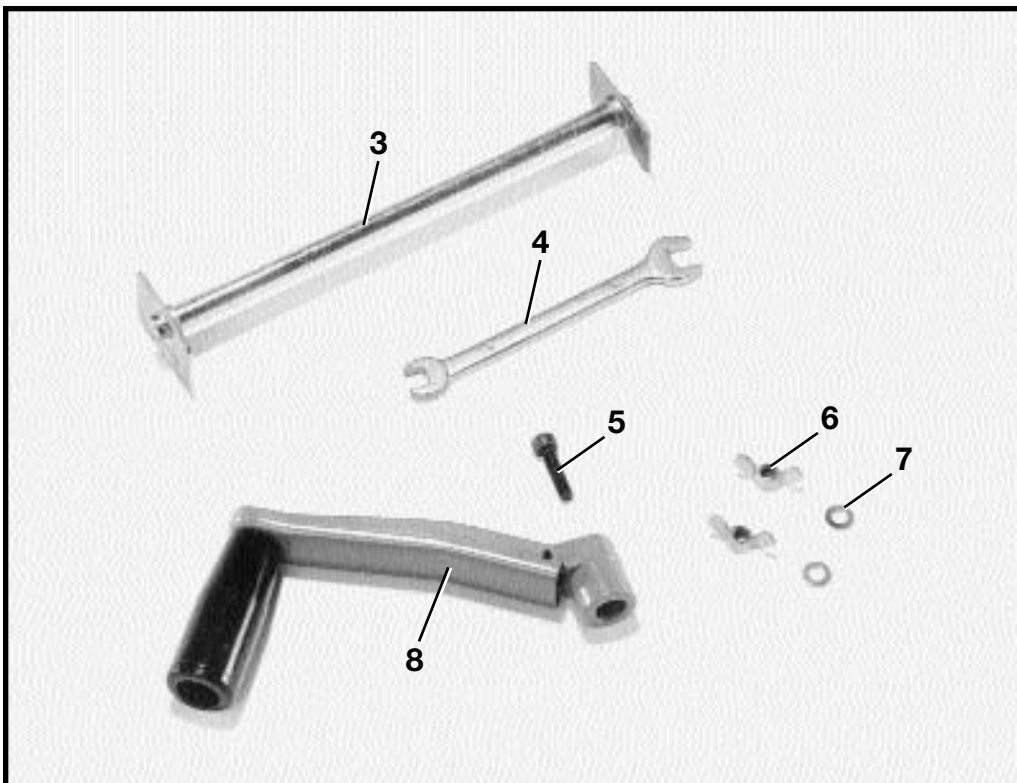

Fig. 3

- 3 - Knife Setting Gage
- 4 - 8mm and 10mm Open-End Wrench
- 5 - M5 x 20mm Hex Socket Head Screw
- 6 - M5 Wing Nut (2)
- 7 - M5 Flat Washer (2)
- 8 - Elevating Handle

ASSEMBLY INSTRUCTIONS

ASSEMBLING RAISING AND LOWERING HANDLE

1. Assemble raising and lowering handle (A) Fig. 4, to shaft (B) and fasten in place with screw (C). **NOTE:** Make certain the flats of the handle and flat on shaft are aligned with each other.

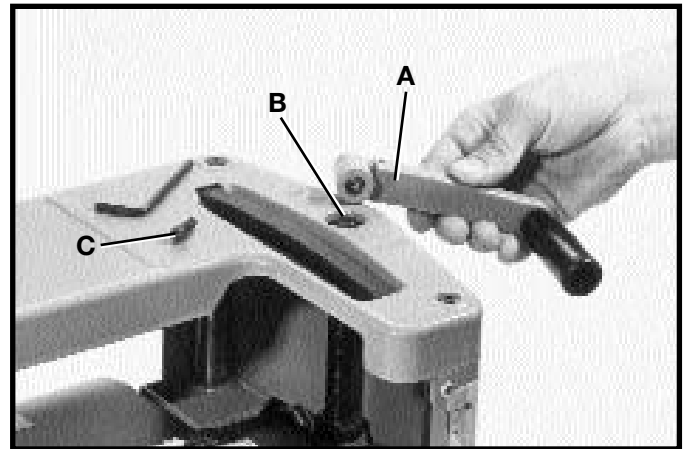

Fig. 4

2. Flip handle (A) upward as shown in Fig. 5.

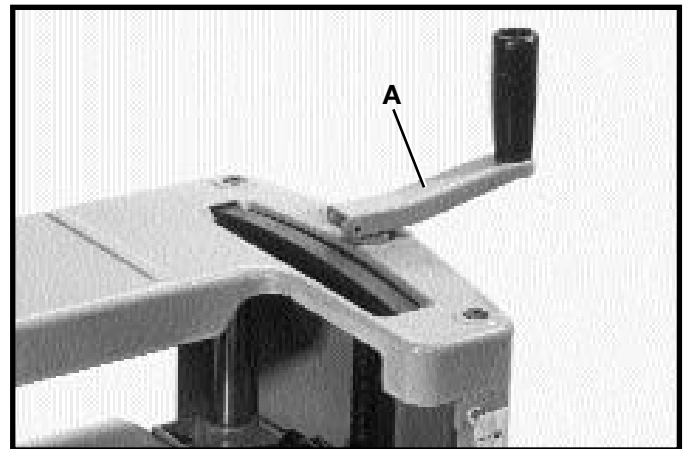

Fig. 5

LOWERING EXTENSION TABLES

The infeed and outfeed extension tables (A) Fig. 6, are shipped attached to the machine in the raised position. Lower the tables (A) on both sides of the planer as shown in Fig. 6. The top surface of extension tables should be level with the planer table. To check and adjust if necessary, refer to section “**LEVELING EXTENSION TABLES**” of this manual.

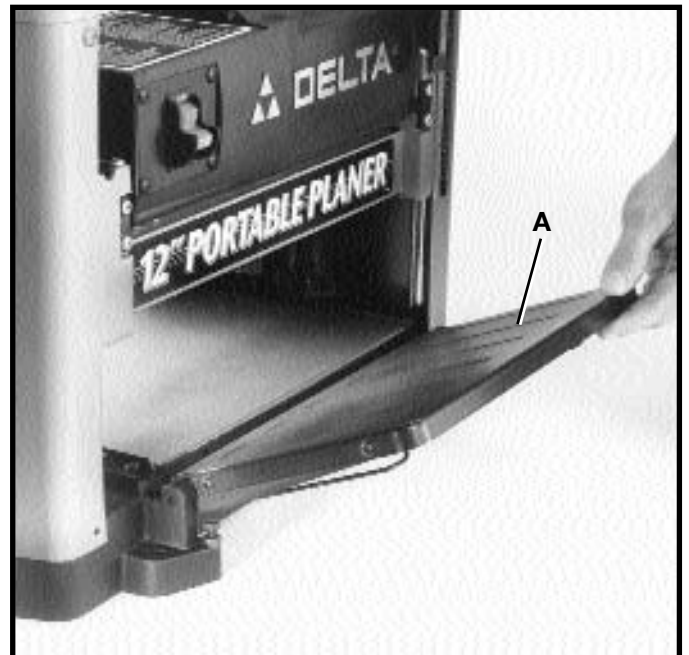

Fig. 6

ASSEMBLING CHIP DEFLECTOR

1. Assemble chip deflector (A) Fig. 7, to the planer by inserting end of chip deflector over the top of the cutterhead. Make certain the two screws, one of which is shown at (B) are inserted upward through the two slots (C) in the chip deflector.

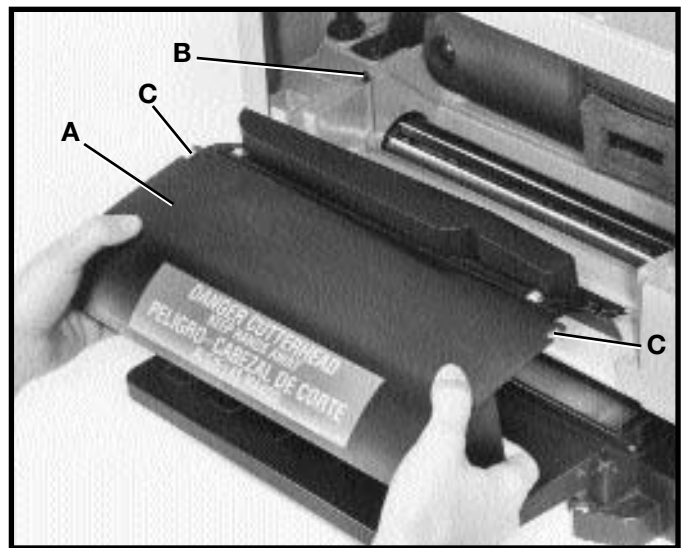

Fig. 7

2. Fasten chip deflector (A) Fig. 8, to planer using two flat washers and wing nuts (D).



Fig. 8

FASTENING PLANER TO SUPPORTING SURFACE

During operation, if there is any tendency for the planer to tip over, slide or “walk” across the supporting surface, the planer must be secured to the supporting surface through the four holes in the base, two of which are shown at (A) Fig. 9.

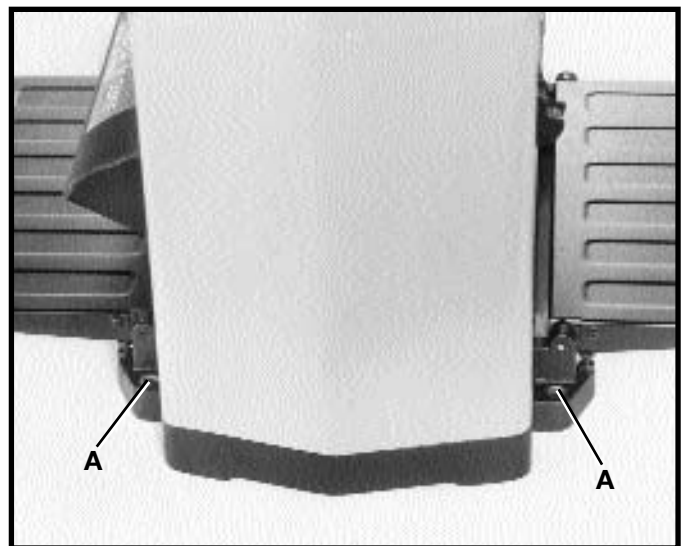

Fig. 9

OPERATING CONTROLS AND ADJUSTMENTS

STARTING AND STOPPING PLANER

The “ON/OFF” switch (A) Fig. 13, is located on the front of the planer motor. To turn the machine “ON”, move the switch toggle (B) to the up position. To turn the switch “OFF”, move the switch toggle (B) to the down position.

LOCKING SWITCH IN THE “OFF” POSITION

IMPORTANT: When the tool is not in use, the switch should be locked in the “OFF” position to prevent unauthorized use. Grasp the switch toggle (B) and pull it out as shown in Fig. 14. With the switch toggle removed, the switch will not operate. However, should the switch toggle (B) Fig. 14, be removed while the machine is running, the switch (A) can be turned “OFF” once, but cannot be restarted without reinserting the switch toggle.

RAISING AND LOWERING HEAD ASSEMBLY

The head assembly (A) Fig. 15, contains the cutterhead feed rolls, chip deflector and motor. Raising and lowering the head assembly controls the depth-of-cut on your planer. To raise or lower the head assembly, rotate the raising and lowering handle (B). **NOTE:** One revolution of the handle will move the cutterhead up or down approximately $5/64$. An English/metric scale (C) and pointer (D) is located on the side of the planer for ease in setting the height of the cutterhead.

RECOMMENDED DEPTH-OF-CUT

A dual English/Metric scale and pointer, located at the right front of the machine, indicates the thickness of the workpiece. **NOTE:** One revolution of the raising and lowering handle (B) Fig. 15, will move the cutterhead up or down $5/64$.

A $3/32$ depth-of-cut can be made in soft woods on stock 8 wide and in hard woods on stock up to 7 wide. See chart Fig. 16.

For 10 and 12 wide **soft wood**, we recommend a maximum depth-of-cut of $1/16$. For 10 and 12 wide hard wood, a maximum depth-of-cut of $3/64$ is recommended. **IMPORTANT: A $3/32$ DEPTH-OF-CUT CAN BE MADE IN 10 AND 12 WIDE SOFT AND HARD WOODS. HOWEVER, CONTINUOUS OPERATION AT THIS CUTTING DEPTH CAN CAUSE PREMATURE MOTOR FAILURE.**

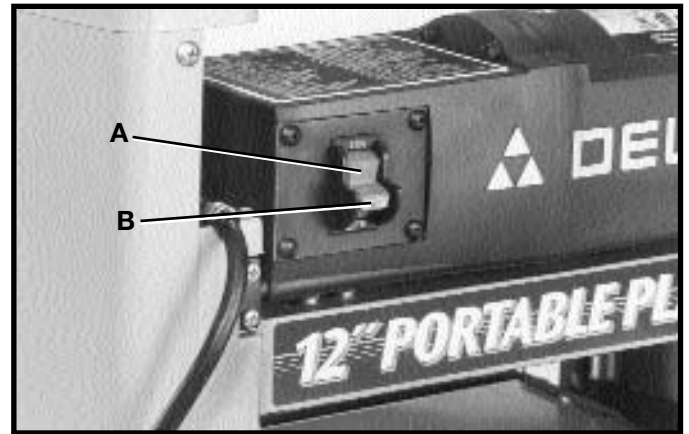

Fig. 13

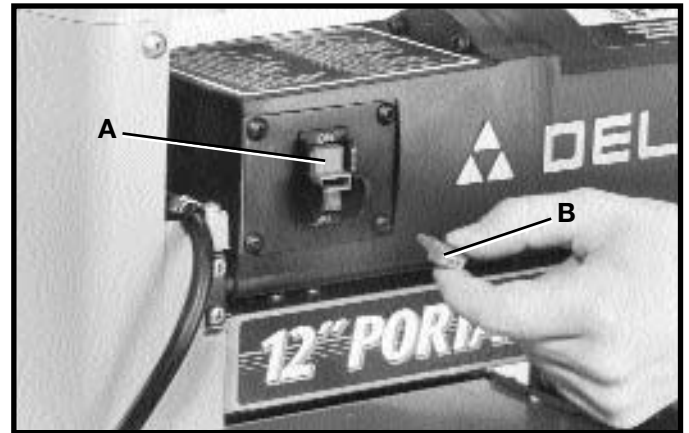

Fig. 14

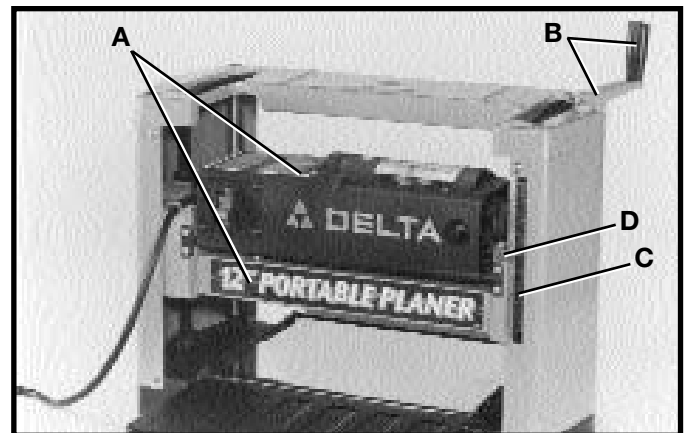

Fig. 15

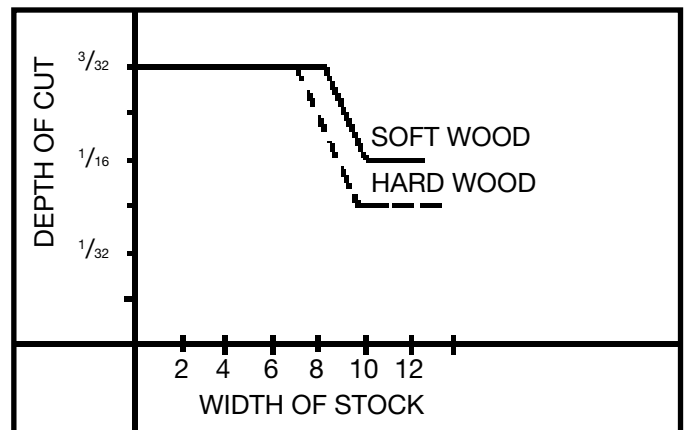

Fig. 16

LEVELING EXTENSION TABLES

For optimum performance, the extension tables, one of which is shown at (A) Fig. 17, must be level with the planer table. To check the extension tables and adjust if necessary, proceed as follows:

1. Place a straight edge (B) Fig. 17, on the infeed extension table (A) with one end extending out over the extension table as shown. Check to see if the infeed table is level with the planer table on both ends of the extension table.
2. If an adjustment is necessary, loosen locknut (C) Fig. 17, and adjust stop screw (D) on each side of the extension table (A) until the extension table is level with the planer table (E); then tighten locknut (C). Recheck and make certain inside edge of table extension is perfectly level with the planer table. If necessary, loosen two screws (F), adjust extension table and retighten two screws (F). Adjust opposite side of the table in the same manner. Make certain the extension table is solidly supported when there is downward pressure on the table.
3. Check and adjust outfeed extension table in the same manner.

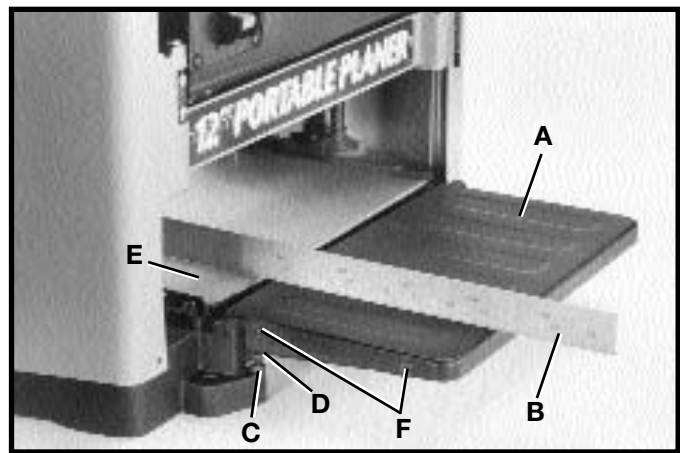

Fig. 17

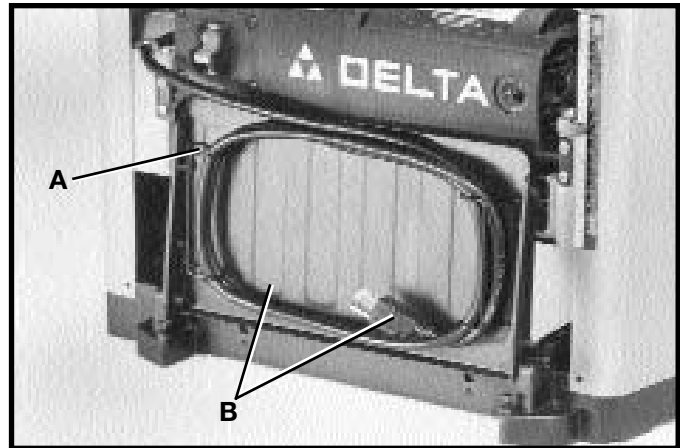

Fig. 18

STORING THE POWER CORD

Wire hangers (A) Fig. 18, are provided on the underside of the outfeed extension table as shown, to store the power cord (B) when the planer is not in use and when transporting the machine.

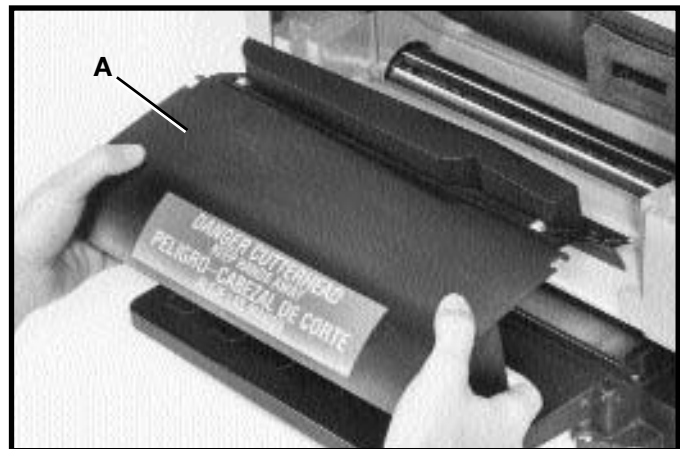

Fig. 19

ADJUSTING KNIVES

To check and adjust the knives, proceed as follows:

1. **DISCONNECT THE TOOL FROM THE POWER SOURCE.**
2. Lower the head assembly by turning handle (B) Fig. 15.
3. Remove chip deflector (A) Fig. 19.
4. Carefully place knife setting gage (B) Fig. 20, on the cutterhead so the rounded sections are directly over the knife as shown. When adjusted correctly, the knife should just contact the bottom of the center portion at each end of gage (B). Check the other knife in the same manner.

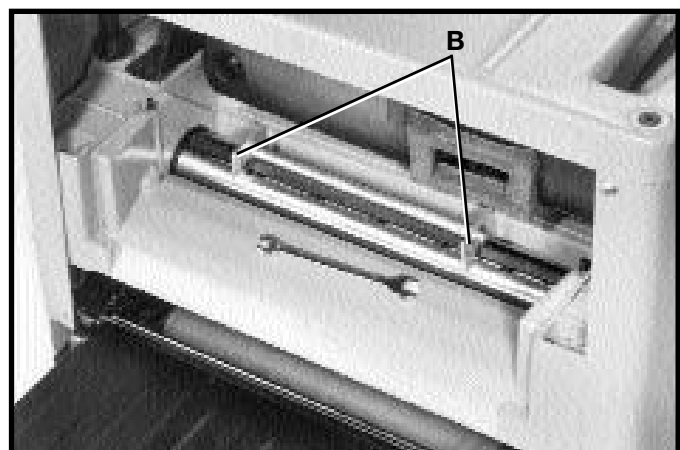

Fig. 20

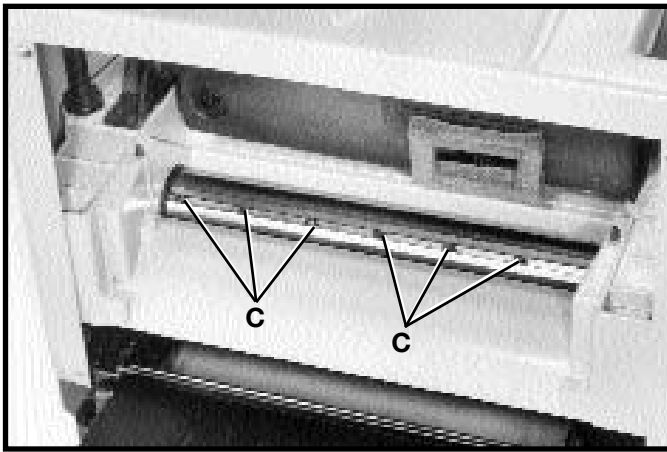

Fig. 21

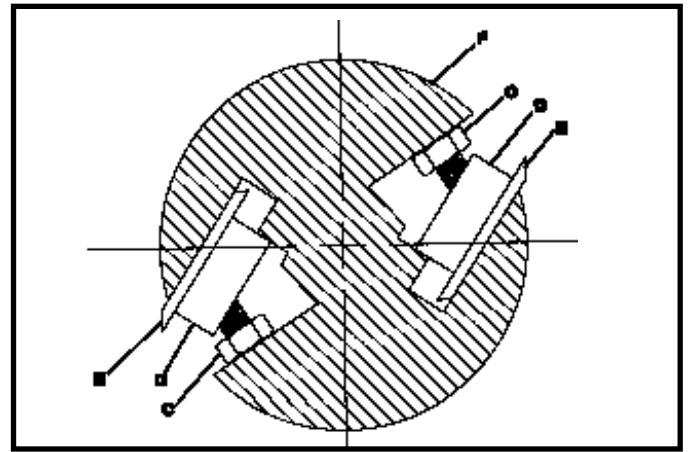

Fig. 22

5. If an adjustment to one or both knives is necessary, slightly loosen the seven locking screws, six of which are shown at (C) Fig. 21, by turning the screws **CLOCKWISE** into the knife locking bar just enough to relieve stress in the cutterhead and not disturb the knife setting.
6. With setting gage (B) Fig. 20, in place, apply pressure to the knife being reset. Turn the seven knife locking screws (C) Fig. 21, **CLOCKWISE** until the knife locking bar becomes loose. Lift springs will automatically raise the knife until it comes in contact with gage (B) Fig. 20. Snug the knife locking bar by lightly turning the seven locking screws (C) Fig. 21, **COUNTERCLOCKWISE**. **IMPORTANT: AT THIS TIME, ONLY TIGHTEN THE KNIFE LOCKING BAR JUST ENOUGH TO HOLD THE KNIFE IN POSITON INSIDE THE CUTTERHEAD SLOT.**
7. If the other knife needs adjustment, repeat **STEP 6**.
8. After both knives are positioned in the cutterhead, turn each of the seven screws, six of which are shown at (C) Fig. 21, **COUNTERCLOCKWISE** until the knife is secure in the cutterhead. **NOTE:** When tightening knife locking screws, tighten the end screws first, then inward toward the center of the cutterhead.
9. Replace chip deflector (A) Fig. 19.

REPLACING AND RESETTING KNIVES

The cutterhead knives supplied with the machine are dual-edged. When one side becomes dull, they can be flipped over and reset in the cutterhead and used again. **CAUTION: IF THE KNIVES ARE TO BE REMOVED FOR SHARPENING OR REPLACEMENT, EXTREME CARE SHOULD BE TAKEN AS THE KNIVES ARE VERY SHARP. TO REPLACE OR RESET THE KNIVES, PROCEED AS FOLLOWS:**

1. **DISCONNECT THE TOOL FROM THE POWER SOURCE.**
2. Lower the head assembly by turning handle (B) Fig. 15.
3. Remove chip deflector (A) Fig. 19.
4. Carefully place knife setting gage (B) Fig. 20, on the cutterhead so the rounded sections are directly over the knife as shown.
5. Loosen the knife locking bar by turning the seven knife locking screws, six of which are shown at (C) Fig. 21, **CLOCKWISE** and carefully remove knife locking bar (D) Fig. 22, knife (E), and springs (not shown) which are located under the knife.
6. Remove the remaining knife in the same manner.
7. Thoroughly clean the knife slots, knife locking bars and screws. Check the screws. If the threads appear worn or stripped or if the heads are damaged, replace them.
8. Carefully replace the springs (not shown), knives (E) Fig. 22, and knife locking bars (D), into both slots of cutterhead (F). **IMPORTANT: WHEN REPLACING KNIFE LOCKING BARS (D) AGAINST KNIVES (E), AS SHOWN IN THE CROSS-SECTIONAL ILLUSTRATION Fig. 22, MAKE CERTAIN THE BARS ARE INSTALLED AS SHOWN, WITH SCREWS (C), POSITIONED AT THE TOP OF KNIFE LOCKING BARS (D), AND ANGLED DOWNWARD HOLDING THE KNIVES (E) PROPERLY INSIDE THE CUTTERHEAD SLOTS. TURN KNIFE LOCKING SCREWS, ONE OF WHICH IS SHOWN AT (C), COUNTERCLOCKWISE JUST ENOUGH TO HOLD BOTH KNIVES (E) IN THE CUTTERHEAD (F).**
9. Adjust both knives as explained in section “**ADJUSTING KNIVES**”, **STEPS 6, 7 and 8.**
10. Replace chip deflector (A) Fig. 19.

LIFTING STRAPS

Your planer is provided with two lifting straps (A) Fig. 23, located on the top of the planer, for ease in transporting the planer.

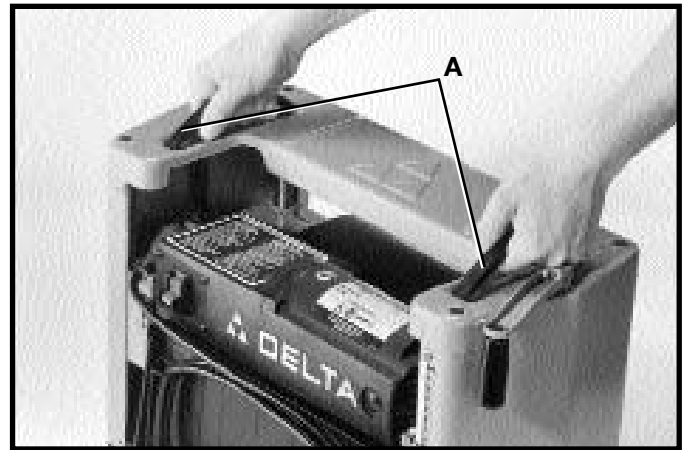

Fig. 23

OPERATIONS

When using your machine, you may want to follow these few simple steps for achieving the best results possible.

1. Cross-cut to Length – Cross-cut rough lumber to length.
2. True Up One Face – Feed one face of the board over a Jointer, making thin cuts with each pass, until the entire surface is flat.
3. Plane to Thickness – Place the side you just surfaced in **STEP 2** face down and feed the board through the Planer, as shown in Figs. 24 and 25. Plane both sides of the board until you are satisfied with the thickness, making thin cuts with each pass. If during the planing operation you notice the board twisting, warping or bowing, repeat **STEP 2** and true up one face.
4. When planing long stock, provide auxiliary tables or rollers to support the infeed and outfeed end of the workpiece.
5. For best results, plane **with** the wood grain only, and keep planer table clean. Occasionally, wax table surface to reduce friction during the planing operation.

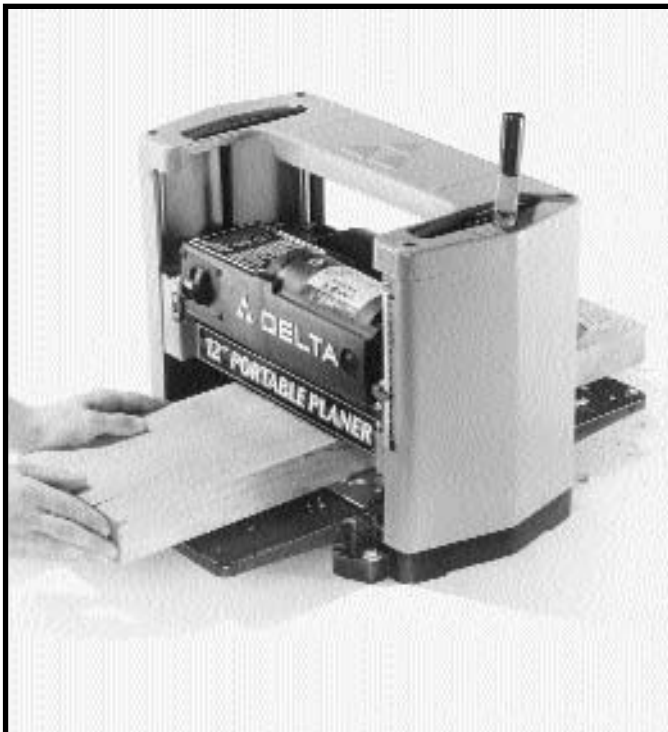

Fig. 24

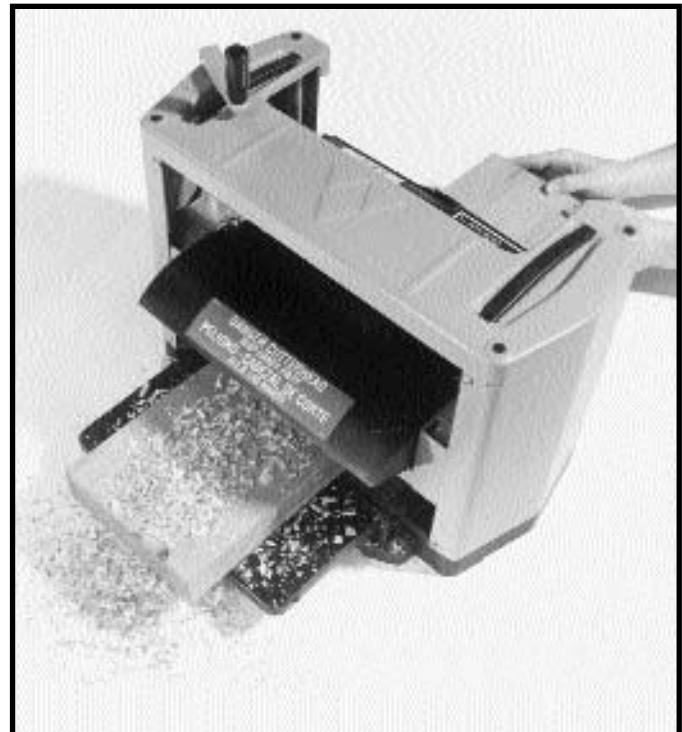

Fig. 25

MAINTENANCE

BRUSH INSPECTION AND REPLACEMENT

CAUTION: BEFORE INSPECTING THE BRUSHES, DISCONNECT THE TOOL FROM THE POWER SOURCE.

Brush life varies. It depends on the load on the motor. Check the brushes after the first 50 hours of use for a new machine or after a new set of brushes has been installed. After the first check, examine them after about 10 hours of use until such time that replacement is necessary.

The brush holders, one of which is shown at (A) Fig. 26, are located on the motor housing opposite each other. Fig. 27, illustrates one of the brushes removed for inspection. When the carbon (B) on either brush is worn to $3/16$ in length or if either spring (C) or shunt wire is burned or damaged in any way, replace both brushes. If the brushes are found serviceable after removing, re-install them in the same position as removed.



Fig. 26

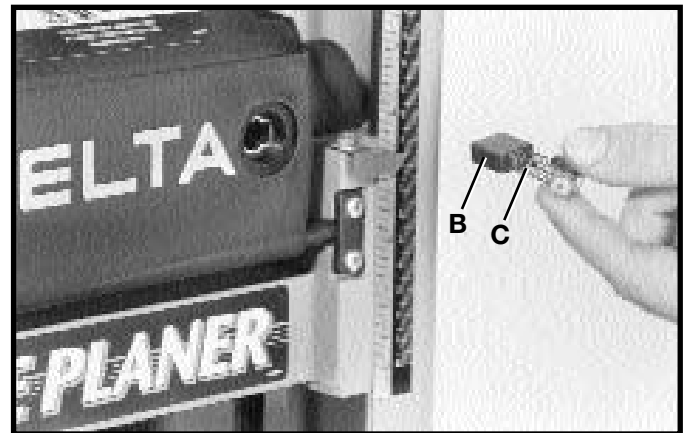

Fig. 27

LUBRICATION

The gears in the gear box and the feed roller bushings should be lubricated periodically, as follows:

1. **DISCONNECT THE TOOL FROM THE POWER SOURCE.**
2. Remove screw (A) Fig. 28, and nut located on the other end of screw. Remove the side cover (B) from the left side of the planer.
3. Place a light coat of E.P. multi-purpose grease on the teeth of the large gear (C) Fig. 29, and a light coat of spray lubricant to chains (F). Replace the side cover.
4. Lay the planer on its back and squirt oil on the feed roller bushings (D) Fig. 30, at each end of the feed rolls (E).

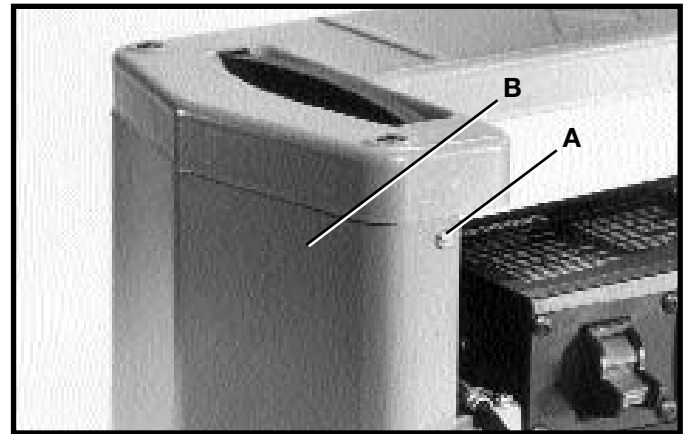

Fig. 28

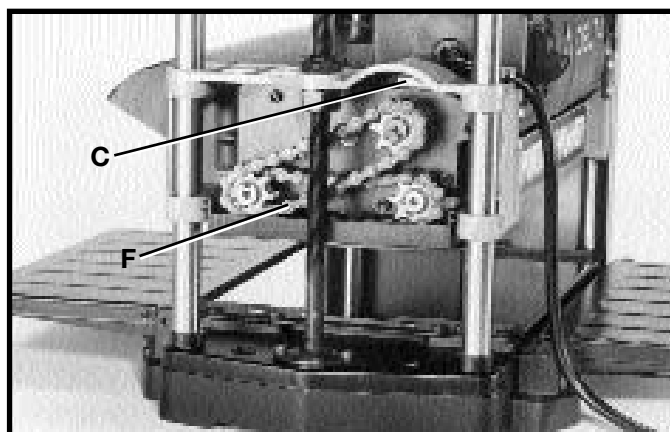



Fig. 29



Fig. 30

ACCESSORIES

A complete line of accessories is available from your Delta Supplier, Porter-Cable · Delta Factory Service Centers, and Delta Authorized Service Stations. Please visit our Web Site www.deltamachinery.com for a catalog or for the name of your nearest supplier.

 **WARNING:** Since accessories, other than those offered by Delta, have not been tested with this product, use of such accessories could be hazardous. For safest operation, only Delta recommended accessories should be used with this product.

22-546 Drive Belt

22-547 HSS Planer Knives

50-322 Stand



PARTS, SERVICE OR WARRANTY ASSISTANCE

All Delta Machines and accessories are manufactured to high quality standards and are serviced by a network of Porter-Cable · Delta Factory Service Centers and Delta Authorized Service Stations. To obtain additional information regarding your Delta quality product or to obtain parts, service, warranty assistance, or the location of the nearest service outlet, please call 1-800-223-7278 (In Canada call 1-800-463-3582).



Delta Building Trades and Home Shop Machinery Two Year Limited Warranty

Delta will repair or replace, at its expense and at its option, any Delta machine, machine part, or machine accessory which in normal use has proven to be defective in workmanship or material, provided that the customer returns the product prepaid to a Delta factory service center or authorized service station with proof of purchase of the product within two years and provides Delta with reasonable opportunity to verify the alleged defect by inspection. Delta may require that electric motors be returned prepaid to a motor manufacturer's authorized station for inspection and repair or replacement. Delta will not be responsible for any asserted defect which has resulted from normal wear, misuse, abuse or repair or alteration made or specifically authorized by anyone other than an authorized Delta Service facility or representative. Under no circumstances will Delta be liable for incidental or consequential damages resulting from defective products. This warranty is Delta's sole warranty and sets forth the customer's exclusive remedy, with respect to defective products; all other warranties, express or implied, whether of merchantability, fitness for purpose, or otherwise, are expressly disclaimed by Delta.

NOTES

NOTES

PORTER-CABLE DELTA SERVICE CENTERS (CENTROS DE SERVICIO DE PORTER-CABLE DELTA)

Parts and Repair Service for Porter-Cable/Delta Power Tools are Available at These Locations
(Obtenga Refaccion de Partes o Servicio para su Herramienta en los Siguientes Centros de Porter-Cable Delta)

ARIZONA

Tempe 85282 (Phoenix)
2400 West Southern Avenue
Suite 105
Phone: (602) 437-1200
Fax: (602) 437-2200

CALIFORNIA

Ontario 91761 (Los Angeles)
3949A East Guasti Road
Phone: (909) 390-5555
Fax: (909) 390-5554

San Leandro 94577 (Oakland)
3039 Teagarden Street
Phone: (510) 357-9762
Fax: (510) 357-7939

FLORIDA

Davie 33314 (Miami)
4343 South State Rd. 7 (441)
Unit #107
Phone: (954) 321-6635
Fax: (954) 321-6638

Tampa 33609
4538 W. Kennedy Boulevard
Phone: (813) 877-9585
Fax: (813) 289-7948

GEORGIA

Forest Park 30297 (Atlanta)
5442 Frontage Road,
Suite 112
Phone: (404) 608-0006
Fax: (404) 608-1123

ILLINOIS

Addison 60101 (Chicago)
311 Laura Drive
Phone: (630) 628-6100
Fax: (630) 628-0023

Woodridge 60517 (Chicago)
2033 West 75th Street
Phone: (630) 910-9200
Fax: (630) 910-0360

MARYLAND

Elkridge 21075 (Baltimore)
7397-102 Washington Blvd.
Phone: (410) 799-9394
Fax: (410) 799-9398

MASSACHUSETTS

Braintree 02185 (Boston)
719 Granite Street
Phone: (781) 848-9810
Fax: (781) 848-6759

Franklin 02038 (Boston)
Franklin Industrial Park
101E Constitution Blvd.
Phone: (508) 520-8802
Fax: (508) 528-8089

MICHIGAN

Madison Heights 48071 (Detroit)
30475 Stephenson Highway
Phone: (248) 597-5000
Fax: (248) 597-5004

MINNESOTA

Minneapolis 55429
4315 68th Avenue North
Phone: (763) 561-9080
Fax: (763) 561-0653

MISSOURI

North Kansas City 64116
1141 Swift Avenue
P.O. Box 12393
Phone: (816) 221-2070
Fax: (816) 221-2897

St. Louis 63119

7574 Watson Road
Phone: (314) 968-8950
Fax: (314) 968-2790

NEW YORK

Flushing 11365-1595 (N.Y.C.)
175-25 Horace Harding Expwy.
Phone: (718) 225-2040
Fax: (718) 423-9619

NORTH CAROLINA

Charlotte 28270
9129 Monroe Road, Suite 115
Phone: (704) 841-1176
Fax: (704) 708-4625

OHIO

Columbus 43214
4560 Indianola Avenue
Phone: (614) 263-0929
Fax: (614) 263-1238

Cleveland 44125
8001 Sweet Valley Drive
Unit #19
Phone: (216) 447-9030
Fax: (216) 447-3097

OREGON

Portland 97230
4916 NE 122 nd Ave.
Phone: (503) 252-0107
Fax: (503) 252-2123

PENNSYLVANIA

Willow Grove 19090
520 North York Road
Phone: (215) 658-1430
Fax: (215) 658-1433

TEXAS

Carrollton 75006 (Dallas)
1300 Interstate 35 N, Suite 112
Phone: (972) 446-2996
Fax: (972) 446-8157

Houston 77055

West 10 Business Center
1008 Wirt Road, Suite 120
Phone: (713) 682-0334
Fax: (713) 682-4867

WASHINGTON

Renton 98055 (Seattle)
268 Southwest 43rd Street
Phone: (425) 251-6680
Fax: (425) 251-9337

Authorized Service Stations are located in many large cities. Telephone **800-487-8665** or **731-541-6042** for assistance locating one. Parts and accessories for Porter-Cable Delta products should be obtained by contacting any Porter-Cable Delta Distributor, Authorized Service Center, or Porter-Cable Delta Factory Service Center. If you do not have access to any of these, call **888-848-5175** and you will be directed to the nearest Porter-Cable Delta Factory Service Center. Las Estaciones de Servicio Autorizadas están ubicadas en muchas grandes ciudades. Llame al **800-487-8665** ó al **731-541-6042** para obtener asistencia a fin de localizar una. Las piezas y los accesorios para los productos Porter-Cable Delta deben obtenerse poniéndose en contacto con cualquier distribuidor Porter-Cable Delta, Centro de Servicio Autorizado o Centro de Servicio de Fábrica Porter-Cable Delta. Si no tiene acceso a ninguna de estas opciones, llame al **888-848-5175** y le dirigirán al Centro de Servicio de Fábrica Porter-Cable Delta más cercano.

ALBERTA

Bay 6, 2520-23rd St. N.E.
Calgary, Alberta
T2E 8L2
Phone: (403) 735-6166
Fax: (403) 735-6144

BRITISH COLUMBIA

8520 Baxter Place
Burnaby, B.C.
V5A 4T8
Phone: (604) 420-0102
Fax: (604) 420-3522

MANITOBA

1699 Dublin Avenue
Winnipeg, Manitoba
R3H 0H2
Phone: (204) 633-9259
Fax: (204) 632-1976

ONTARIO

505 Southgate Drive
Guelph, Ontario
N1H 6M7
Phone: (519) 836-2840
Fax: (519) 767-4131

QUÉBEC

1515 ave.
St-Jean Baptiste,
Québec, Québec
G2E 5E2
Phone: (418) 877-7112
Fax: (418) 877-7123

1447, Begin
St-Laurent, (Montréal), Québec
H4R 1V8
Phone: (514) 336-8772
Fax: (514) 336-3505

The following are trademarks of PORTER-CABLE DELTA Corporation (Las siguientes son marcas registradas de PORTER-CABLE S.A.): BAMMER®, INNOVATION THAT WORKS®, JETSTREAM®, LASERLOC®, OMNIJIG®, POCKET CUTTER®, PORTA-BAND®, PORTA-PLANE®, PORTER-CABLE®, QUICKSAND®, SANDTRAP®, SAW BOSS®, SPEED-BLOC®, SPEEDMATIC®, SPEEDTRONIC®, STAIR-EASE®, THE PROFESSIONAL EDGE®, THE PROFESSIONAL SELECT®, TIGER CUB®, TIGER SAW®, TORQBUSTER®, WHISPER SERIES®, DURATRONIC™, FLEX™, FRAME SAW™, MICRO-SET™, MORTENT™, NETWORK™, RIPTIDE™, TRU-MATCH™, WOODWORKER'S CHOICE™.

Trademarks noted with ® are registered in the United States Patent and Trademark Office and may also be registered in other countries. Las Marcas Registradas con el signo de ® son registradas por la Oficina de Registros y Patentes de los Estados Unidos y también pueden estar registradas en otros países.