

JVC**COMPACT COMPONENT SYSTEM****NX-D7** — Consists of **CA-NXD7, SP-NXD7F, and SP-NXD7W****NX-D5** — Consists of **CA-NXD5, SP-NXD7F, and SP-NXD7W****NX-D3** — Consists of **CA-NXD3 and SP-NXD3****NX-DC3** — Consists of **CA-NXDC3 and SP-NXDC3***Thank you for purchasing a JVC product.***INSTRUCTIONS**GVT0276-002A[US/UN/UG/UX/A/WJ]
0409WKMMDWJMM

©2009 Victor Company of Japan, Limited

**MP3/WMA/WAV MPEG-4**
ASF PLAYBACK

GVT0276-002A

Warnings, Cautions and Others**CAUTION**

The button in any position does not disconnect the mains line.

Disconnect the mains plug to shut the power off completely (the STANDBY lamp goes off).

The MAINS plug or an appliance coupler is used as the disconnect device, the disconnect device shall remain readily operable.

- When the System is on standby, the STANDBY lamp lights red.
- When the System is turned on, the STANDBY lamp goes off.

The power can be remote controlled.

CAUTION:

- To reduce the risk of electrical shocks, fire, etc.:
- Do not remove screws, covers or cabinet.
 - Do not expose this appliance to rain or moisture.

CAUTION:

- Do not block the ventilation openings or holes. (If the ventilation openings or holes are blocked by a newspaper or cloth, etc., the heat may not be able to get out.)
- Do not place any naked flame sources, such as lighted candles, on the apparatus.
- When discarding batteries, environmental problems must be considered and local rules or laws governing the disposal of these batteries must be followed strictly.
- Do not expose this apparatus to rain, moisture, dripping or splashing and that no objects filled with liquids, such as vases, shall be placed on the apparatus.

IMPORTANT FOR LASER PRODUCTS

- CLASS 1 LASER PRODUCT**
- CAUTION:** Do not open the top cover or cabinet. There are no user serviceable parts inside the unit; leave all servicing to qualified service personnel.
- CAUTION:** Visible and/or invisible class 1M laser radiation when open. Do not view directly with optical instruments.
- REPRODUCTION OF LABEL: CAUTION LABEL, PLACED INSIDE THE UNIT.**

CAUTION VISIBLE AND/OR INVISIBLE CLASS 1 LASER RADIATION WHEN OPEN. DO NOT VIEW DIRECTLY WITH OPTICAL INSTRUMENTS. REPRODUCTION OF LABEL REQUIRED.	ATTENTION NE PAS OUVRIER LE COFFRET EN MARCHE. IL Y A RADIATION LASER VISIBLE ET/OU INVISIBLE DE CLASSE 1. NE PAS REGARDER DIRECTEMENT AVEC DES INSTRUMENTS OPTIQUES. REPRODUCTION DU LABEL OBLIGATOIRE.	AVISO NO ABRIRE EL CUBIERTO CON EL APARATO EN ENCENDIDO. HAY RADIACION LASER VISIBLE Y/O INVISIBLE DE CLASE 1. NO MIRE DIRECTAMENTE CON INSTRUMENTOS OPTICOS. REPRODUCCION DEL LABEL OBLIGATORIA.	WARNING DO NOT OPEN THE COVER WHILE THE UNIT IS ON. LASER RADIATION IS EMISSION VISIBLE AND/OR INVISIBLE OF CLASS 1. DO NOT VIEW DIRECTLY WITH OPTICAL INSTRUMENTS. REPRODUCTION OF LABEL IS REQUIRED.	注意 この製品は レーザー放射を 発生する 可能性があります。 開蓋時、レーザー 放射が放出され ることがありま す。レーザー放射 を直接見ると 失明の恐れが あります。また、 望遠鏡等の光学 器具を用いて 見ると、失明の 恐れがあります。 開蓋時は、直 接見たり、光学 器具を用いて 見たりしないで ください。 レーザー放射の 発生防止のため 、この製品の 蓋を開けるとき は、必ずこのラ ベルを貼って ください。	CAUTION VISIBLE AND/OR INVISIBLE CLASS 1 LASER RADIATION WHEN OPEN. DO NOT VIEW DIRECTLY WITH OPTICAL INSTRUMENTS. REPRODUCTION OF LABEL REQUIRED.
---	--	---	---	--	---

CAUTION: Proper Ventilation

To avoid risk of electric shock and fire, and to prevent damage, locate the apparatus as follows:

- Front: No obstructions and open spacing.
- Sides/Top/Back: No obstructions should be placed in the areas shown by the dimensions below.
- Bottom: Place on the level surface. Maintain an adequate air path for ventilation by placing on a stand with a height of 10 cm or more.

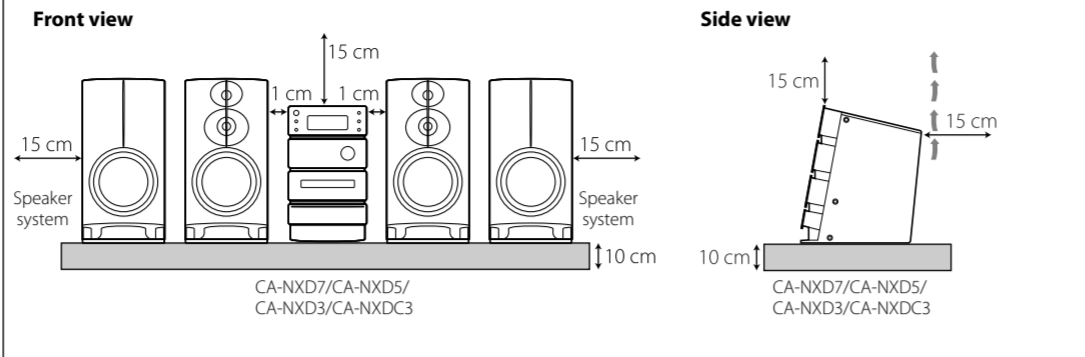
**(European Union only)****CAUTION:**
Excessive sound pressure from earphones or headphones can cause hearing loss.**CAUTION:**
Battery shall not be exposed to excessive heat such as sunshine, fire, or the like.**Mains (AC) Line Instruction**

(Excluding Australian models)

CAUTION for mains (AC) line

- BEFORE PLUGGING IN, do check that your mains (AC) line voltage corresponds with the position of the voltage selector switch provided on the outside of this equipment and, if different, reset the voltage selector switch, to prevent from a damage or risk of fire/electric shock.
- Use a screwdriver to slide the voltage selector to the correct voltage in the area you are plugging in the unit.

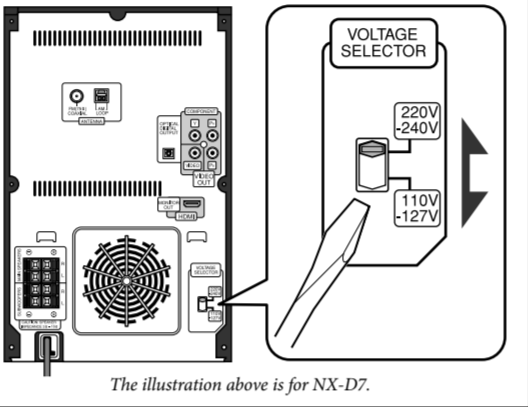
**Learning More about This System****Connections**

- Make sure the antenna conductors do not touch any other terminals, connecting cords or the power cord. Also, keep the antennas away from metallic parts of the System, connecting cords, and the power cord. These could cause poor reception.
- Use only speakers with the same speaker impedance as indicated by the speaker terminals on the rear of the System.
- The speakers are magnetically shielded to avoid color distortions on TVs. However, if not installed properly, it may cause color distortions. So, pay attention to the following when installing the speakers.
 - When placing the speakers near a TV set, turn off the TV's main power switch or unplug it before installing the speakers.
 - Then wait at least 30 minutes before turning on the TV's main power switch again.
- Some TVs may still be affected even though you have followed the above instructions. If this happens, move the speakers away from the TV.
- You cannot connect a computer and JVC Everio camcorder to the USB terminals of the System.
- Noise and static electricity may stop the USB device sound. In this case, disconnect and connect the USB device again after turning off the System.

Preparations**To change the color system and scanning mode:**

- You cannot change the scanning mode to progressive in the following cases:
 - When your TV does not support the progressive video input.
 - When you have not connected your TV to the System using a component video cord or an HDMI cable.

Basic Operations**Setting the ECO (Ecology) Mode:**

- If you turn on the Daily Timer or the Recording Timer (for NX-D7) while the ECO mode is activated, the ECO mode is canceled.

Listening to a Disc/USB Device

JVC bears no responsibility for any loss of data in the USB mass storage class device while using this System.

- When connecting with a USB cable, use the USB 2.0 cable whose length is less than 1 m.
- You can connect a USB device such as a USB flash memory device, hard disk drive, multimedia card reader, etc. to this System.
- When you change the source to "DVD/CD" or "USB," it may take a while to activate the source.
- While the System is reading a disc, the source may not change to "USB1" or "USB2" properly. In this case, press , then change the source to "USB1" or "USB2."
- On some discs, the actual operations may be different from what is explained in this manual due to the programming and disc structure; such differences are not a malfunction of this System.
- The total number of tracks (files) that the System can detect is 4 000 for "DVD/CD" and "USB1," and 2 000 for "USB2."
- The System recognizes up to...
 - 999 tracks (files) per group.
 - 99 groups per disc, "USB 1" (for NX-D7), and "USB" (for NX-D5/NX-D3/NX-DC3).
 - 999 groups per "USB 2."
- Unplayable files are also counted in the total file number. Playable files which do not belong to any groups are recognized as files of group 1.

Program Play/Random Play/Group Play:

- Program is cleared in the following cases:
 - When the System is turned off (standby).
 - For USB2 (NX-D7), when the source is changed to USB1.
- While programming steps...
 - Your entry will be ignored if you have tried to program an item number that does not exist (for example, selecting track 14 on a disc that only has 12 tracks).
 - For MP3/WMA/WAV files, you can program up to 99 files.
 - You cannot select the 151st or later tracks.

Playing Repeatedly:

- A-B Repeat cannot be used for MP3/WMA/WAV/JPEG/MPEG-1/MPEG-2/ASF/DivX files and some DVDs.

To select the audio track:

- On some discs/files, you cannot change audio language during playback.

Zoom:

- While zoomed in, the picture may look coarse.

On-screen Operations**Operating the On-screen Bar:**

- A-B Repeat is available only within the same title/original program/track.

Setup Menu**General:**

- If the upper and lower parts of the menu are cut off, adjust the picture size control of the TV.

LANGUAGE menu:

- When the language you have selected for "MENU LANGUAGE," "AUDIO LANGUAGE," or "SUBTITLE" is not recorded, the original language is used as the initial language.

PICTURE menu—MONITOR TYPE:

- Even if "4:3 PS," "4:3 MULTI PS" is selected, the screen size may become 4:3 letter box while playing a disc/file. This depends on how the discs are recorded.
- When you select "16:9 NORMAL," "16:9 MULTI NORMAL" or "16:9 AUTO," "16:9 MULTI AUTO" for a picture whose aspect ratio is 4:3, the picture changes slightly due to the process of converting the picture width.

OTHERS menu—ON SCREEN GUIDE:

- The setup menu and on-screen bar will be displayed (and recorded) even if this function is set to "OFF." Subtitles and the information for zoom-in always appear on the display regardless of this setting.

Timer Operations**General:**

- When the System is on standby, you cannot set Daily Timer or Recording Timer (for NX-D7).

Setting the Clock:

- "0:00" will flash on the display until you set the clock.
- The clock may gain or lose 1 to 2 minutes per month. If this happens, reset the clock.

Setting the Daily Timer:

- If you do not specify the preset station or track number correctly while setting a timer, the currently selected station or the first track will be played when the timer is activated.
- When you unplug the power cord or if a power failure occurs, the timer will be canceled. You need to set the clock first, then the timer again.
- If you set DVD Video as the source, Daily Timer will not work correctly.
- If you set the Sleep Timer after Daily Timer starts playing the selected source, Daily Timer is canceled.

Listening to the Radio

- If you store a new station into an occupied preset number, the previously stored station in that number will be erased.
- When you unplug the power cord or if a power failure occurs, the preset stations will be erased in a few days. If this happens, preset the stations again.

Listening to a Tape (for NX-DC3)

- If you open the slide door on the top of the main unit during playback, the playback stops.
- You cannot pause tape playback.

Sound & Picture Adjustments**Adjusting the Sound:**

- This function also affects the sound through the headphones.

Setting My Sound (for DVD/CD and USB1):

- My Sound setup is prohibited for certain file format.
- My Sound setup is prohibited during recording/editing or while Mic Mixing is activated.

Enjoying Karaoke**General:**

- You cannot enjoy all the Karaoke functions with DVD-VR, video files and picture files.
- While the System is turned on, connecting a microphone automatically activates Mic Mixing and all the Karaoke related functions.
- While the System is turned off, connecting a microphone does not activate Mic Mixing and any other Karaoke related function. In this case, press MIC MIX after turning the System on.
- You cannot activate Mic Mixing during My Sound setup.
- While recording, connecting microphones does not automatically activate Mic Mixing.

Adjusting the Sound Track for Karaoke:

- Vocal Masking is not applied to the optical digital output signals through the OPTICAL DIGITAL OUTPUT terminal.
- For some music files, Vocal Masking does not provide the correct effect.

Recording Operations**Recording from a Disc (for NX-D7):**

- When you press USB REC, ">1 ONLY" appears on the display in the following cases:
 - While Program Play or Random Play is selected.
 - When "HQ REC" is selected for the transfer rate.

Editing Operations**Editing Titles to Tracks or Groups:**

- When a track is recorded, a title is automatically given to the track. When you want to give a new title to the track, delete the old title, then enter your desired title.
- For NX-D5/NX-D3/NX-DC3, you cannot edit files while using Karaoke function.

Precautions**Notes on the power cord**

- When you are away on travel or otherwise for an extended period of time, remove the plug from the wall outlet.
- When unplugging the System from the wall outlet, always pull the plug, not the power cord.
- Do not handle the power cord with wet hands.
- Disconnect the power cord before cleaning the System or moving the System.
- Do not alter, twist or pull the power cord, or put anything heavy on it, which may cause fire, electric shock, or other accidents.
- If the cord is damaged, consult a dealer and have the power cord replaced with a new one.

Avoid moisture, water, dust, and high temperatures

- Do not place the System in moist or dusty places.
- If water gets inside the System, turn off the power and remove the plug from the wall outlet, then consult your dealer. Using the System in this state may cause a fire or electrical shock.
- Do not expose the System to direct sunlight or place it near a heating device.

Notes on installation

- Select a place which is level, dry and neither too hot nor too cold—between 5°C and 35°C.
- Do not install the System in a place subject to vibrations.
- Do not put heavy objects on the System.
- Do not drag or push the speakers on the floor or table; otherwise, the four feet at the bottom side of each speaker may peel off or drop from the speaker.
- To prevent malfunction or damage of the System**
- Do not insert any metallic objects, such as wires, hairpins, coins, etc. into the System.
- Do not block the vents.

There are no user-serviceable parts inside. If anything goes wrong, unplug the power cord and consult your dealer.

Introduction**Playable Disc/File Types**

MP3/WMA/WAV	MPEG-4 ASF PLAYBACK	
<ul style="list-style-type: none"> CD-R/-RW: Recorded in the Audio CD, Video CD, and SVCD formats. MP3, WMA, WAV, JPEG, MPEG-1, MPEG-2, ASF, and DivX files written in accordance with the "ISO 9660" format can also be played. DVD-R/-RW +R/+RW: MP3, WMA, WAV, JPEG, MPEG-1, MPEG-2, ASF, and DivX files written in the UDF-Bridge format can be played. DVD-R/-RW: Recorded in the DVD Video format and the DVD Video Recording (VR) format. DVD+R: Recorded in the DVD Video format. USB device: MP3, WMA, WAV, JPEG, MPEG-1, MPEG-2, ASF, and DivX* files. 		

In addition to the above discs/files, this System can play back audio data recorded on CD-Extra and CD-G (CD-Graphics).

- The following discs cannot be played back: DVD-RAM, CD-I (CD-I Ready), and Photo CD.
- Playing back these discs will generate noise and damage the speakers.
- CD Text and DVD Text can be played, but text information will not be shown on the display.
- This System can play back Everio file with the extension code <.mod> recorded on DVD, CD*, and USB device*.

* Only when the maximum bit rate is less than 2 Mbps.

Caution for DualDisc playback

The Non-DVD side of a "DualDisc" does not comply with the "Compact Disc Digital Audio" standard. Therefore, the use of the Non-DVD side of a DualDisc in this product may not be recommended.

IMPORTANT: Before playing a disc/file, make sure of the following...

- Turn on the TV and select an appropriate input mode on the TV to view the pictures or on-screen displays.
- For disc/file playback, you can change the initial setting to your preference. Refer to "Setup Menu" in "Operating Guide."
- If appears on the TV screen when you press a button, the disc/file cannot perform the operation you have tried to do.

- When playing a multi-channel encoded software, the System properly converts the multi-channel signals into 2 channels, and emits the downmixed sound from the speakers. To enjoy the powerful sound of these multi-channel encoded software, connect a proper decoder or an amplifier with a proper built-in decoder to the OPTICAL DIGITAL OUTPUT terminal on the rear.

About color system

This System accommodates both NTSC and PAL system and can play back discs/files recorded in either system. To change the color system, see "Preparations."

Note on Region Code

- DVD players and DVDs have their own Region Code numbers. This System can play back only DVDs with an appropriate Region Code number.
- For details, see "Specifications."
- "REGION ERR" appears if DVD with a wrong Region Code is loaded.
- Ex.: For Southeast Asia

**License and Trademark**

- "DVD Logo" is a trademark of DVD Format/Logo Licensing Corporation.
- Manufactured under license from Dolby Laboratories. "Dolby" and the double-D symbol are trademarks of Dolby Laboratories.
- Manufactured under license under U.S. Patent numbers: 5,451,942; 5,956,674; 5,974,380; 5,978,762; 6,487,535 and other U.S. and worldwide patents issued & pending. DTS and DTS 2.0 + Digital Out are registered trademarks and the DTS logos and Symbol are trademarks of DTS, Inc. © 1996-2007 DTS, Inc. All Rights Reserved.

- DivX* is a registered trademark of DivX, Inc., and is used under license.
- ABOUT DIVX VIDEO: DivX* is a digital video format created by DivX, Inc. This is an official DivX Certified or DivX Ultra Certified device that plays DivX video.
- ABOUT DIVX VIDEO-ON-DEMAND: This DivX* Certified device must be registered in order to play DivX VOD content. [Important: DivX VOD content is protected by a DivX DRM (Digital Rights Management) system that restricts playback to registered DivX Certified devices. If you try to play DivX VOD content not authorized for your device, the message "Authorization Error" will be displayed and your content will not play.] Learn more at www.divx.com/vod.
- Plays DivX* video
- Microsoft and Windows Media are either registered trademarks or trademarks of Microsoft Corporation in the United States and/or other countries.
- This product incorporates copyright protection technology that is protected by U.S. patents and other intellectual property rights. Use of this copyright protection technology must be authorized by Macrovision, and is intended for home and other limited viewing uses only unless otherwise authorized by Macrovision. Reverse engineering or disassembly is prohibited.
- "CONSUMERS SHOULD NOTE THAT NOT ALL HIGH DEFINITION TELEVISION SETS ARE FULLY COMPATIBLE WITH THIS PRODUCT AND MAY CAUSE ARTIFACTS TO BE DISPLAYED IN THE PICTURE. IN CASE OF 525 OR 625 PROGRESSIVE SCAN PICTURE PROBLEMS, IT IS RECOMMENDED THAT THE USER SWITCH THE CONNECTION TO THE 'STANDARD DEFINITION' OUTPUT. IF THERE ARE QUESTIONS REGARDING OUR TV SET COMPATIBILITY WITH THIS MODEL 525p AND 625p DVD PLAYER, PLEASE CONTACT OUR CUSTOMER SERVICE CENTER."
- USE OF THIS PRODUCT IN ANY MANNER THAT COMPLIES WITH THE MPEG-4 VISUAL STANDARD IS PROHIBITED, EXCEPT FOR USE BY A CONSUMER ENGAGING IN PERSONAL AND NON-COMMERCIAL ACTIVITIES.
- HDMI, the HDMI logo and High-Definition Multimedia Interface are trademarks or registered trademarks of HDMI Licensing LLC.
- HDCP is the abbreviation of "High-bandwidth Digital Content Protection," and is the high-reliable copy control technology licensed by Digital Content Protection, LLC.

Troubleshooting**General**

- Adjustments or settings are suddenly canceled before you finish.**
- ⇒There is a time limit. Repeat procedure again.

Operations are disabled.

- ⇒The built-in microprocessor may malfunction due to external electrical interference. Unplug the power cord and then plug it back in.

Unable to operate the System from the remote control.

- ⇒The path between the remote control and the remote sensor on the System is blocked.
- ⇒The batteries are exhausted.

No sound is heard.

- ⇒Speaker connections are incorrect or loose.
- ⇒Headphones are connected.

No picture appears on the TV screen.

- ⇒The video cord connections are incorrect or loose.

No picture is displayed on the TV screen, the picture is blurred, or the picture is divided into two parts.

- ⇒The System is connected to a TV which does not support progressive video input.
- ⇒Incorrect scanning mode is selected (see "Preparations").
- ⇒When you unplug the power cord and plug it back again, the scanning mode may change back to the initial setting (see "Preparations").

The left and right edges of the picture are missing on the screen.

- ⇒Select "4:3 LB," "4:3 MULTI LB" for "MONITOR TYPE" (refer to "Setup Menu" on page 20).

Radio Operations**Hard to hear broadcasts because of noise.**

- ⇒Antenna connections are incorrect or loose.
- ⇒The AM loop antenna is too close to the System.
- ⇒The FM antenna is not properly extended and positioned.

Disc/USB Device Playback Operations**The disc does not play.**

- ⇒You have inserted a disc whose Region Code is not correct. ("REGION ERR" appears on the display.)
- ⇒The disc is placed upside down. Place the disc with the label side facing up.

ID3 Tag on an MP3 file cannot be shown.

- ⇒Two types of ID3 Tag exist—Version 1 and Version 2. This System can only show ID3 Tag Version 1.

Groups and tracks are not played back as you expect.

- ⇒The playing order is determined when the groups and tracks were recorded. It depends on the writing application.

MP3, WMA, WAV, JPEG, MPEG-1, MPEG-2, ASF or DivX files are not played back.

- ⇒The disc or the USB device may contain different types of files (ex. MP3/WMA/WAV/JPEG). In this case, you can only play back the files selected by pressing FILE TYPE.
- ⇒You have changed the "FILE TYPE" setting after the System read the disc or the USB device. In this case, reload the disc or disconnect the USB device and connect it again.

The disc sound is discontinuous.

- ⇒The disc is scratched or dirty.

No subtitle appears on the display though you have selected the initial subtitle language.

- ⇒Some DVDs are programmed not to display any subtitle initially. If this happens, press SUBTITLE after starting playback.</

Connections

Do not connect the power cord until all other connections have been made.

Supplied Accessories

- After unpacking, check to be sure that you have all the following items.
- FM antenna (x1)
 - AM loop antenna (x1)
 - Composite video cord (x1)
 - Remote control (x1)
 - Batteries (x2)
 - AC plug adapter (x1) (Not supplied for Australia, Thailand and the Middle East.)
- If any items are missing, consult your dealer immediately.

AM/FM antenna

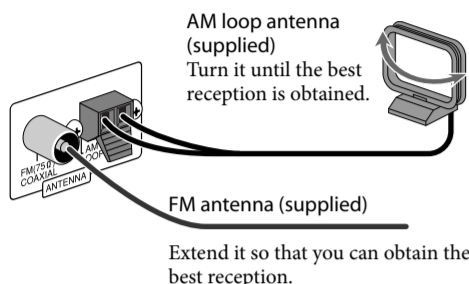

To assemble the AM loop antenna

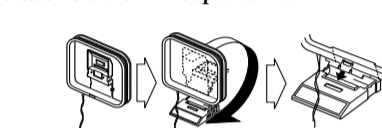

Keep the AM loop antenna cable wrapped around the AM loop antenna frame, otherwise the effectiveness and sensitivity of the AM loop antenna may be reduced.

For better FM reception, disconnect the supplied FM antenna, and connect to an outdoor FM antenna using a 75 Ω wire with coaxial type connector (IEC or DIN45325).

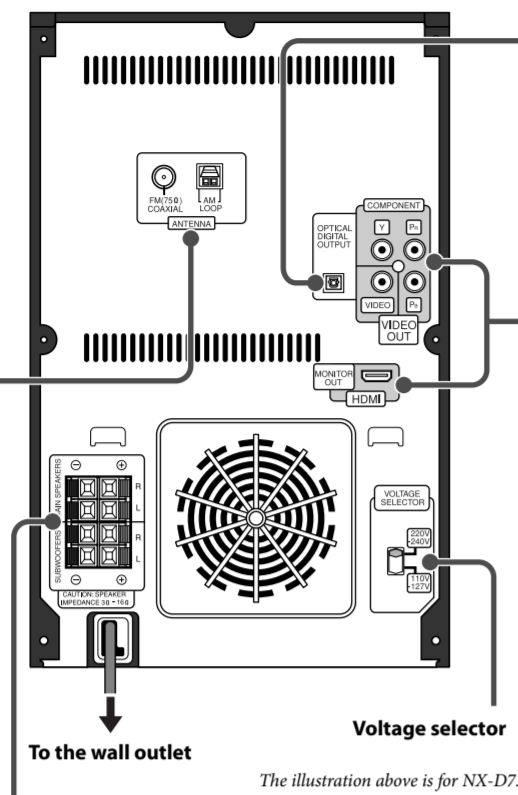

Speakers

When connecting the speaker cords, match the polarity.

- NX-D7/NX-D5:**
Main speakers: Blue to (+) and black to (-)
Subwoofer(s): Red to (+) and black to (-)
- NX-D3/NX-DC3:**
Red to (+) and black to (-)

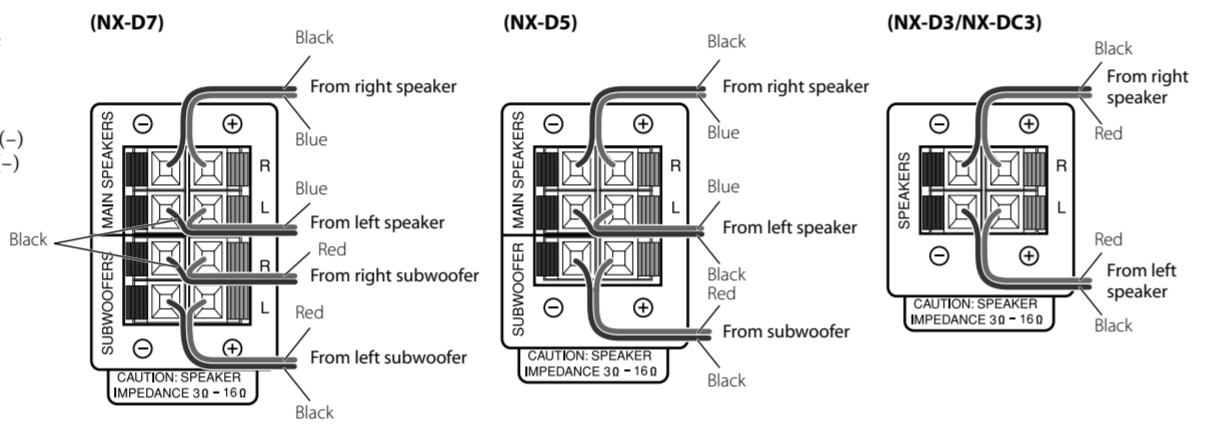

Digital audio component

- Set "DIGITAL AUDIO OUTPUT" in the "AUDIO" menu correctly according to the connected digital audio equipment (refer to "Setup Menu" in "Operating Guide").
- Digital signal through the OPTICAL DIGITAL OUTPUT terminal is transmitted only when "DVD/CD" or "USB1" is selected as the source.

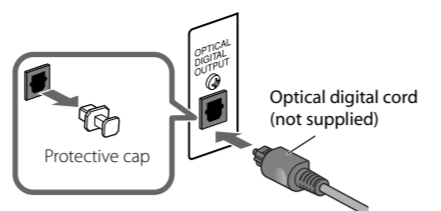

TV/monitor

- Connect your TV directly to the System. Connecting the System to a TV via other device, such as a VCR or an HDD/DVD recorder, may interfere with your viewing. Connecting an integrated TV/VCR system to the System may also interfere with your viewing.
- After connecting a TV, select the appropriate video signal output according to the color system. See "Preparations."
- To select progressive scanning mode, use the COMPONENT jacks or HDMI terminal.
- When you use an HDMI cable, make appropriate settings in the Setup Menu (refer to "Setup Menu" in "Operating Guide").

VIDEO OUT jacks

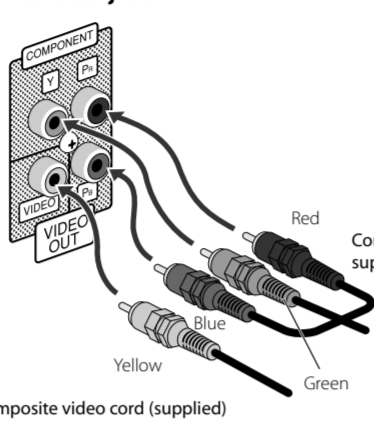

MONITOR OUT terminal (only for NX-D7/NX-D5)



- When you start playback on the main unit, the input of the connected TV compatible with HDMI CEC automatically changes to the HDMI.
- When the HDMI cable and the component video cord are connected at the same time, the output of the VIDEO OUT will not perform properly.

Basic Operations

- In this manual, operations using the remote control are mainly explained; however, you can use the buttons and controls on the main unit if they have the same (or similar) name and marks.
- Illustrations used in this manual is mainly of NX-D7. They may look different from the model you have.
- "USB 1" (for NX-D7) mentioned in this manual can be understood as "USB" (for NX-D5/NX-D3/NX-DC3).
- Button and control operations are explained in the table below.

	Indicates that you press the button.
	Indicates that you press and hold the button for a specified period.
	Indicates that you slide your finger on the volume jog in the specified direction(s).

How to cancel the demonstration

- Press and hold DEMO button on the main unit (until "DEMO CLEAR" appears on the display) while on standby.
- When the ECO Mode is activated, the demonstration does not work.
 - Refer to the attached sheet "Information about the demonstration function."

When using the remote control

- Point the top of the remote control towards the remote sensor as directly as possible. If you operate it from a diagonal position, the operating range (about 5 m) may be shorter.

DO NOT turn off (standby) the System with the volume set at an extremely high level; otherwise, the sudden blast of sound may damage your hearing, speakers and/or headphones when you turn on the System or start playback.

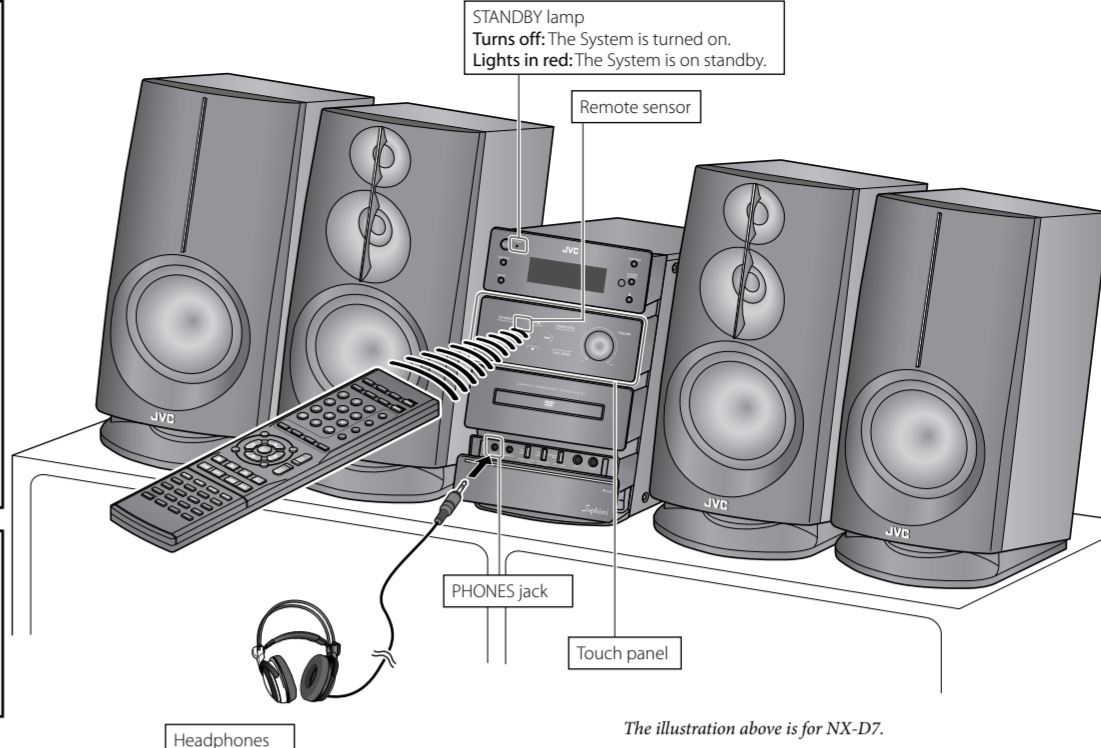

The illustration above is for NX-D7.

For private listening

- Connect a pair of headphones to the PHONES jack on the main unit. The sound will no longer come out of the speakers. "HPHONE IN" appears on the display for a while. Be sure to turn down the volume before connecting or putting on the headphones.
- Disconnecting the headphones will activate the speakers again.
 - When using the headphones with the L-shaped plug, connect it with the head of the plug facing the right side as illustrated below.

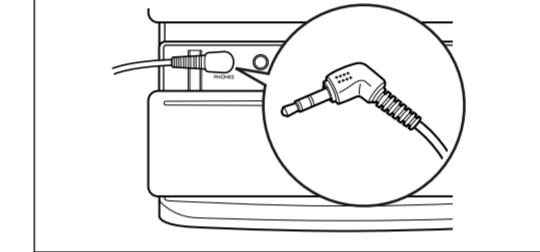

Motion Sensor

- When you move your hand close to the remote sensor in the following cases, the illumination on the front panel turns on.
- While the System is on standby.
 - When "DIMMER 1" or "DIMMER 2" is selected.
 - When "AUTO DIMMER" is selected and playing moving and still pictures.

To activate or deactivate the motion sensor, press MOTION SENSOR.

- When the motion sensor is activated, "SELECT SOURCE" appears on the display while on standby.
- When the motion sensor is deactivated, the clock is shown on the display while on standby.
- When the ECO Mode is activated, the motion sensor does not work.

Turning On/Off the Power

On the main unit	On the remote

- Selecting a source (see below) while in standby mode also turns on the System.

Selecting the Source

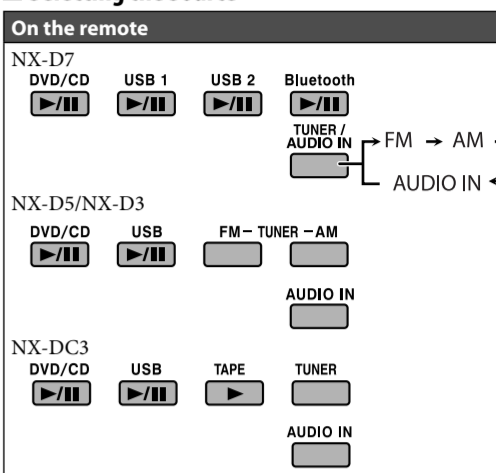

On the main unit

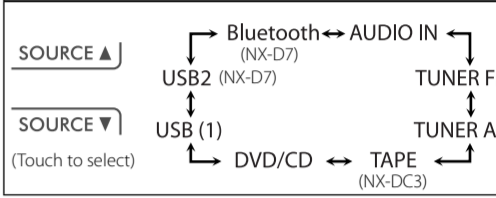

Adjusting the Volume

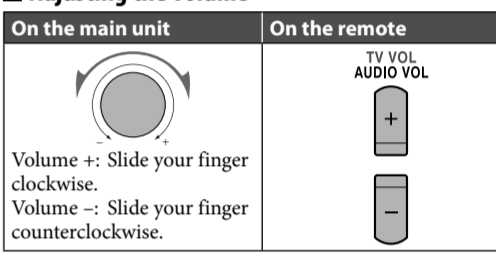

To drop the volume in a moment

- Press the MUTE button.
- To restore the volume, press again or adjust the volume level.

Preparations

Preparing the remote control

Insert the batteries into the remote control by matching the polarity (+ and -) correctly.

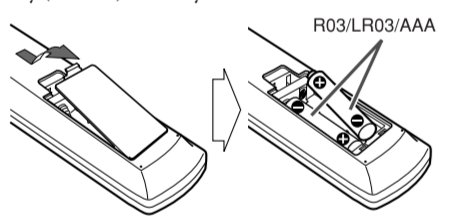

If the range or effectiveness of the remote control decreases, replace both batteries.

Caution:
Be careful your children do not put the batteries into their mouths.

About HDMI CEC

- CEC is device controlling signals optionally employed for the HDMI standard. When devices equipped with CEC are connected, each device can control the others. This System is compatible with some basic functions of HDMI CEC. For example, when you start playback on the System, the connected TV compatible with HDMI CEC automatically turns on.
- This function is available only when the source is set to "DVD/CD" or "USB1."
 - You can select or deactivate the usage for the HDMI CEC functions using "CEC" on Setup Menu (refer to "Setup Menu" in "Operating Guide").

ON 1	To use the HDMI CEC functions normally.
ON 2	Select this if you do not want to have the System automatically turned on/off by turning on/off the TV or other external HDMI CEC compatible devices. All other available HDMI CEC functions operate the same as when "ON 1" is selected.
OFF	To deactivate the HDMI CEC functions.

- For details about the CEC function, refer to the operation manuals of the connected CEC devices.
- The CEC function may not work depending on the settings or status of the System or the connected CEC devices.

To change the color system and scanning mode

You can select the video output to match it to the color system of your TV (NTSC or PAL).

- If you connect a progressive TV through the component video cords or the HDMI cable, you can enjoy a high quality picture by selecting progressive scanning mode.
 - You can change the setting only while playback is stopped.
- While "DVD/CD" is selected as the source and playback is stopped...

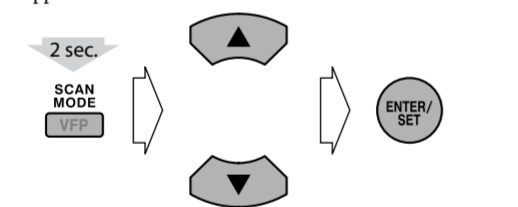

For NX-D7/NX-D5

AUTO	The System automatically emits the video signal to get the best picture quality on your TV.
PAL 576P / PAL 720P / PAL 1080i / PAL 1080P	For a PAL TV. P: Progressive I: Interlaced
NTSC 480P / NTSC 720P / NTSC 1080i / NTSC 1080P	For a NTSC TV. P: Progressive I: Interlaced

When an HDMI cable is not connected

PAL 576i / PAL 576P	For a PAL TV. Select "PAL 576P" if you connect a progressive TV through the COMPONENT jacks.
NTSC 480i / NTSC 480P	For a NTSC TV. Select "NTSC 480P" if you connect a progressive TV through the COMPONENT jacks.

For NX-D3/NX-DC3

PAL/NTSC	For a conventional PAL or NTSC TV.
PAL PRGR / NTSC PRGR	For a progressive PAL or NTSC TV.

Specifications

Amplifier section—NX-D7/NX-D5/NX-D3/NX-DC3

Output Power:
NX-D7:
 MAIN SPEAKERS 230 W (115 W + 115 W) at 3 Ω (10% THD)
 SUBWOOFERS 230 W (115 W + 115 W) at 3 Ω (10% THD)

NX-D5:
 MAIN SPEAKERS 230 W (115 W + 115 W) at 3 Ω (10% THD)
 SUBWOOFER 115 W at 3 Ω (10% THD)

NX-D3/NX-DC3:
 230 W (115 W + 115 W) at 3 Ω (10% THD)

Audio Input: AUDIO IN: Stereo mini (φ 3.5 mm)
 500 mV/47 kΩ (at "AUDIO LVL3")
 250 mV/47 kΩ (at "AUDIO LVL2")
 125 mV/47 kΩ (at "AUDIO LVL1")

Digital Input/Output:

- OPTICAL DIGITAL OUTPUT (output only): -21 dBm to -15 dBm (660 nm ±30 nm)
- NX-D7:**
 Bluetooth ADPT
 USB1:VIDEO/AUDIO PLAY (input only)
 USB2:AUDIO REC/PLAY (input and output)
 HDMI MONITOR OUT (output only)
- NX-D5:**
 USB:REC/PLAY (input and output)
 HDMI MONITOR OUT (output only)
- NX-D3/NX-DC3:**
 USB:REC/PLAY (input and output)

VIDEO OUT:

- Color system: NTSC/PAL (interlaced/progressive)
 VIDEO (Composite): 1 V(p-p)/75 Ω
 COMPONENT: (Y) 1 V(p-p)/75 Ω
 (Pb/Pa) 0.7 V(p-p)/75 Ω

HDMI MONITOR OUT (NX-D7/NX-D5):

480p/576p/720p/1080i/1080p

Speaker impedance: 3 Ω - 16 Ω

Tuner section

- FM tuning range: 87.50 MHz - 108.00 MHz
 531 kHz - 1 710 kHz (at 9 kHz)
 AM tuning range: 530 kHz - 1 710 kHz (at 10 kHz)

Disc player section

- Region codes: Middle East: 2 / South East Asia: 3 / Central and South America, Australia: 4
 Dynamic range: 80 dB
 Horizontal resolution: 500 lines
 Wow and flutter: Immeasurable

USB section

- Recording format: MP3/WMA format
 USB specification: Compatible with USB 2.0 Full Speed
 Compatible device: Mass storage class
 Compatible system: FAT16, FAT32
 Bus power supply: DC 5 V ≒ 500 mA

Bluetooth section (NX-D7)

- Version: Bluetooth ver. 2.0 + EDR Class 1/Class 2
 Compatible Bluetooth profile:A2DP, AVRCP
 Communication format: 2.4 GHz FHSS

HDMI section (NX-D7/NX-D5)

Output power: DC 5 V ≒ 55 mA

Cassette deck section (NX-DC3)

- Frequency response: Normal (Type 1): 50 Hz - 14 000 Hz
 Wow and flutter: 0.15% (WRMS)

General

- Power requirements:
 AC 110 - 127/220 - 240 V ~, 50/60 Hz
 For Australia: AC 240 V ~, 50 Hz
- Power consumption:
 NX-D7: 130 W (at operation)/21 W (at standby) / 1 W or less (at ECO mode)
 NX-D5: 85 W (at operation)/16 W (at standby) / 1 W or less (at ECO mode)
 NX-D3/NX-DC3: 65 W (at operation)/14 W (at standby) / 1 W or less (at ECO mode)

Dimensions (approx.):

- 195 mm × 333 mm × 313 mm (W × H × D)

Mass (approx.):

- NX-D7/NX-D5: 3.5 kg
 NX-D3: 3.4 kg
 NX-DC3: 3.7 kg

Main Speaker—SP-NXD7F/SP-NXD3

- Type: 3-way 3-speaker Bass Reflex Type (Magnetically-Shielded Type)

- Speaker units:
 Tweeter :2.0 cm cone x 1
 Mid Range :5.0 cm cone x 1
 Woofer :16.0 cm cone x 1
- Impedance: 3 Ω
 Power handling capacity :115 W
 Frequency range :40 Hz - 20 000 Hz
 Sound pressure level :84 dB/W·m
 Dimensions (W × H × D) :205 mm × 409.5 mm × 290.5 mm
 Mass :3.6 kg each

Subwoofer—SP-NXD7W

- Type: 1-Way Bass Reflex Type (Magnetically-Shielded Type)

- Speaker units :16.0 cm cone x 1
 Impedance :3 Ω
 Power handling capacity :115 W
 Frequency range :40 Hz - 5 000 Hz
 Sound pressure level :83 dB/W·m
 Dimensions (W × H × D) :205 mm × 409.5 mm × 290.5 mm
 Mass :3.5 kg

Design and specifications are subject to change without notice.

Changing the Display Brightness

You can dim the display and illumination lamp.

DIMMER	ECO/DIMMER
DIMMER 1	Dims the display and the blue illumination on the main unit.
DIMMER 2	Dims the display more than DIMMER 1 and turns off the blue illumination on the main unit.
AUTO DIMMER	Dims the display automatically to the same level as DIMMER 2 and turns off the blue illumination while playing moving pictures or still pictures.
DIMMER OFF	Normal brightness.

Setting the ECO (Ecology) Mode

Setting the ECO Mode allows you to reduce power consumption by turning the display off while on standby. While the System is on standby...

On the main unit	On the remote

To cancel, repeat the procedure.

Turning Off the Power Automatically

Auto Standby

- This does not function while "FM," "AM" or "AUDIO IN" is selected as the source.

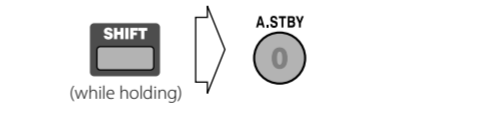

To cancel, repeat the procedure.

Sleep Timer

1 Specify the time (in minutes).

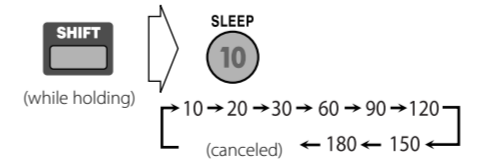

2 Wait until the set time disappears.

To check the time remaining until the shut-off time, press SLEEP (while holding SHIFT) once.

To change the display information

- The information displayed and its order vary among the source.

TITLE SEARCH / DISPLAY/CHARA (NX-D7)	DISPLAY/CHARA (NX-D5/NX-D3/NX-DC3)

AUDIO IN:

Current source information → Remaining time for recording (NX-D7)*1 → Clock

TUNER AM or FM:

Frequency → Remaining time for recording (NX-D7)*1 → Clock

DVD/CD:

Current source information → Folder name, file name and tag information (for MP3, WMA, WAV) → Title and chapter number (while playing)*2/Disc or file type (while stopped) → Remaining time for recording (NX-D7)*1 → Clock

USB:

Current source information → Folder name, file name and tag information (for MP3, WMA, WAV) → Title and chapter number (while playing)*2/Disc or file type (while stopped) → Clock

*1 Only while a USB device is connected to the USB2 terminal. When the remaining time exceeds 100 hours, "REM -:-:-:-" appears.

*2 Only while playing back the following discs/files:
 DVD-VR: Program number/Play List number and chapter number.
 MP3/WMA/WAV/PEG/MPEG-1/MPEG-2/ASF/DivX files: Group and file numbers.
 DVD Video: Title and chapter numbers.

Bluetooth (NX-D7):

Current source information → Connected device name → Clock

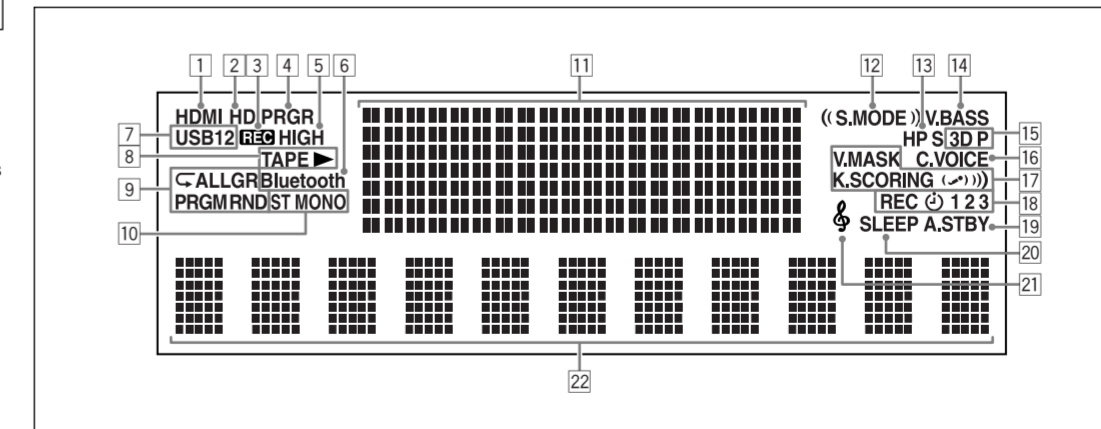

- HDMI indicator (for NX-D7/NX-D5)
- HD indicator (for NX-D7/NX-D5)
- REC (Recording) indicator
- PRGR (Progressive) indicator
- Recording mode indicator (for NX-D7)
- Bluetooth indicator (for NX-D7)
- USB 1/2 indicator
- TAPE indicator (for NX-DC3)
- Karaoke operation indicators
 - KSCORING (Karaoke Scoring) indicator
 - GR indicator
 - PRGM indicator
 - RND indicator
 - Repeat Mode indicators
- Play mode indicators
 - ALL / G / PRG / C
- FM reception indicators
- Level meter
- Sound Mode indicators
 - S.MODE (Sound Mode) indicator
 - (()) (Surround) indicator
- HP S (Headphone Surround) indicator
- V.BASS (Vario Bass) indicator
- 3D P (3D Phonic) indicator
- C.VOICE (Clear Voice) indicator
- Karaoke operation indicators
 - KSCORING (Karaoke Scoring) indicator
 - (M) (Mic Mixing) indicator
 - (E) (Echo) indicator
 - V.MASK (Vocal Masking) indicator
- Timer indicators (REC; for NX-D7)
- A.STBY (Auto Standby) indicator
- SLEEP indicator
- My Sound indicator
- Main display

The illustration above is for NX-D7.

Using the number buttons and cursor buttons on the remote control

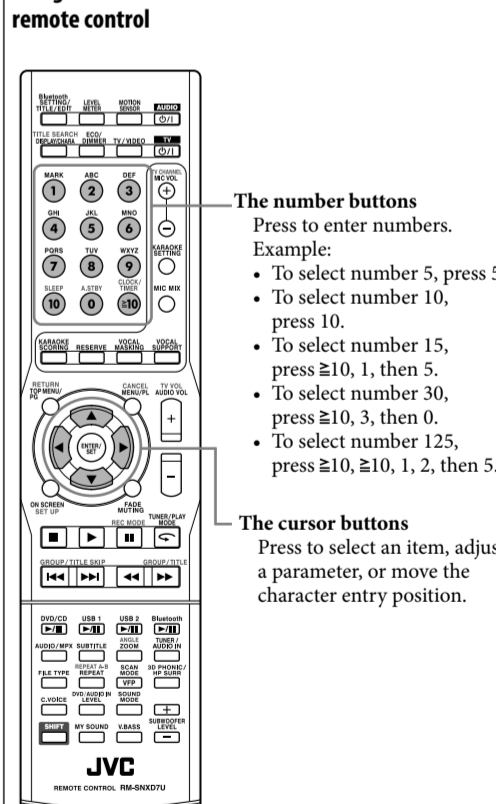

The number buttons

- Press to enter numbers. Example:
- To select number 5, press 5.
 - To select number 10, press 10.
 - To select number 15, press 10, 1, then 5.
 - To select number 30, press 10, 3, then 0.
 - To select number 125, press 10, 10, 1, 2, then 5.

The cursor buttons

Press to select an item, adjust a parameter, or move the character entry position.

The illustration above is for NX-D7.