

# iLuv™

## Auto Speaker Phone with *Bluetooth*® Wireless Technology



### Instruction Manual i322

Please read this manual carefully before operating and save it  
for future reference.

**Have a question? Please visit <http://www.i-Luv.com>**

# USER SAFETY GUIDE

## INSTRUCTIONS ON ENVIRONMENT PROTECTION

Do not dispose of this product in the usual household garbage at the end of its life cycle; bring it to a collection point for the recycling of electrical and electronic appliances.

This symbol on the product means the instructions for use or the packaging will inform about the methods of disposal. The materials are recyclable as mentioned in its marking. By recycling, material recycling, and other forms of re-utilization of old appliances, you make an important contribution to the protection of the environment. Please inquire at your local community administration for an authorized disposal location.



## Important Safety Instructions

1. **Read instructions** – All safety and operating instructions should be read before the appliance is operated.
2. **Retain instructions** – The safety and operating instructions should be retained in a secure place for future reference.
3. **Heed warnings** – All warnings on the appliance and in the operating instructions should be observed.
4. **Follow instructions** – All operating and use instructions should be followed.
5. **Water and moisture** – The appliance should not be used near water (bathtub, kitchen sink, laundry tub, pool, etc.).
6. **Heat** – The appliance should be situated away from heat

# USER SAFETY GUIDE

## Important Safety Instructions-Continued

sources such as radiators, heat registers, stoves, or other appliances (including amplifiers) that produce heat.

7. **Power sources** – The appliance should be connected to a power supply only of the type described in the operating instructions or as marked on the appliance.
8. **Cleaning** – The appliance should be cleaned with a dry cloth.
9. **Objects and liquids entry** – Care should be taken so that objects do not fall and liquids are not spilled into the device's openings.
10. **Servicing** – The user should not attempt to service the appliance beyond that described in the user's operating instructions. All other servicing should be referred to qualified service professional.

## FCC Notice (USA)

This device complies with Part 15 of the FCC Rules. Operation is subject to the following two conditions: (1) this device may not cause harmful interference, and (2) this device must accept any interference received, including interference that may cause undesired operation. Refer to 47 CFR Sec. 15.19.

This equipment has been tested and found to comply with the limits for a Class B digital device, pursuant to Part 15 of the FCC Rules. These limits are designed to provide reasonable protection against harmful interference in a residential installation. This equipment generates, uses, and can radiate radio frequency energy and, if not installed and used in accordance with the instructions, may cause harmful interference to radio

# USER SAFETY GUIDE

## FCC Notice (USA)-Continued

communications, which can be determined by turning the equipment off and on, the user is encouraged to try to correct the interference by one or more of the following measures:

- Reorient or relocate the receiving antenna.
- Increase the separation between the equipment and receiver.
- Connect the equipment into an outlet on a circuit different from that to which the receiver is connected.
- Consult the dealer or an experienced radio/TV technician for help.

**NOTE: Changes or modifications not expressly approved by the party responsible for compliance could void the user's authority to operate the equipment. Refer to 47 CFR Sec. 15.21.**

## Industry Canada Notice to Canadian Users

Operation is subject to the following two conditions: (1) this device may not cause harmful interference, and (2) this device must accept any interference received, including interference that may cause undesired operation of the device. Refer to IC RSS 210 Sec. 5.11. The term "IC" before the certification or registration number only means that the registration was performed based on a Declaration of Conformity and that Industry Canada technical specifications were met. It does not imply that Industry Canada (IC) approved this equipment. Refer to Self-Marking 6(f) and RSP 100 Sec. 4.

# USER SAFETY GUIDE

## Additional Safety Instructions

- When not in use, keep your device in a safe place where it will not be bent or crushed.
- Keep this device away from children. Some small and detachable parts might be swallowed by children and result in harm to them.
- This unit contains magnets. Keep magnets away from computers, discs, video tapes, color TV sets, and wallets or purses containing credit cards.

## About Electromagnetic Interference (EMI)

This device is designed and manufactured not to exceed the exposure limit for radio frequency energy, which is set by the Federal Communications Commission of the U.S government.

The term “EMI” is short for the electromagnetic interference caused by the electromagnetic field generated by electronic devices. In fact, most electrical appliances and devices emit electric and magnetic fields, and most of modern electronic devices are susceptible to the EMI if they are inadequately shielded or designed.

- If you use any personal medical device, such as a pacemaker, please consult the manufacture of your medical device to determine if it is adequately shielded from EMI. Your physician might assist you in obtaining this information.

# USER SAFETY GUIDE

## IMPORTANT NOTES ON HEARING

Your hearing is very important to you and to us. We strongly recommend you to follow the guideline below in order to prevent possible damage to or loss of hearing.

Hearing experts caution that listening to loud sounds can damage hearing over time. With continuous listening to loud sounds, hearing adapts and will give the impression that volume has reduced. What seems normal may, in fact, be harmful. To guard against this before hearing adapts, set the volume at a low level and slowly increase the volume level until sound can be heard comfortably and clearly without distortion. Damage to hearing is accumulative and is irreversible. Ringing or discomfort in the ears indicates that the volume is too loud. Once a comfortable listening level has been established, do not increase the volume level further.

### Cautions

- If you experience a ringing sound in your ear, lower the volume or discontinue the use of this product.
- Although this product allows hands-free operation, talking on the phone while driving can be distracting. Do not play the speaker at high volume as warning signals such as a car horn may not be heard, resulting in an accident. Avoid emotionally-charged phone conversations and pay close attention to traffic signals and signs as well as other vehicles on the road.

# TABLE OF CONTENTS

## GETTING STARTED

Introduction.....	7
What's Included in the Package.....	8
What is <i>Bluetooth</i> wireless technology? .....	8
Location of Controls.....	9
Reading the LCD Screen... ..	10
Charging the Speaker Phone Unit.....	11
Turning on the Speaker Phone.....	11
Pairing the Speaker Phone.....	12

## OPERATING INSTRUCTIONS

Menu Mode.....	13
Setting the Ring Tone.....	13
Storing Numbers in the Phone Book.....	14
Downloading the Phone Book.....	15
Storing Numbers in the Hotline.....	17
Deleting Numbers from the Hotline.....	17
Closing the Menu Mode.....	17
Making a Call.....	18
Receiving a Call.....	19
Adjusting a Volume.....	19
Muting the Microphone.....	20
Ending / Rejecting a Call.....	20
Transferring a Call.....	20
Call Waiting.....	20
Turning off the Speaker Phone.....	20

## TROUBLESHOOTING GUIDE

Questions and answers about the product.....	21
----------------------------------------------	----

## SPECIFICATIONS

Technical information about the product.....	22
----------------------------------------------	----

# GETTING STARTED

## Auto Speaker Phone with *Bluetooth* Wireless Technology

Thank you for purchasing the i322 from iLuv. This speaker phone has been designed for mobile phone connection using *Bluetooth* wireless technology. Please keep this manual in a safe place for future reference.



- Digital Signal Processor (DSP)
- Answer mobile phone calls hands free
- Phonebook function
- Caller ID display
- Hotline function
- Adjustable LCD
- Supports the headset (HSP), hands-free (HFP), and object push profiles
- Standby time up to 200 hours
- Continuous talking time up to 8 hours
- Communication range up to 33ft
- Compliant with *Bluetooth* wireless technology V2.0



## GETTING STARTED

### What's included in the package?

- Speaker Phone unit
- Clamp
- Car Charger
- Instruction manual
- Warranty card



### What is *Bluetooth* wireless technology?

*Bluetooth* wireless technology is a short-range wireless communication technology intended to replace the cables connecting electronic devices while maintaining the high level of security. With *Bluetooth* wireless technology, two devices can be connected at the same time without the need to face each other or the concern of interference from other wireless communication within its optimum range of 33 feet.

Through a process called "Pairing," two or more devices with *Bluetooth* wireless technology can interact with each other without interference from other wireless platforms nearby, including other *Bluetooth* wireless communications between unrelated devices.

# GETTING STARTED

## LOCATION OF CONTROLS

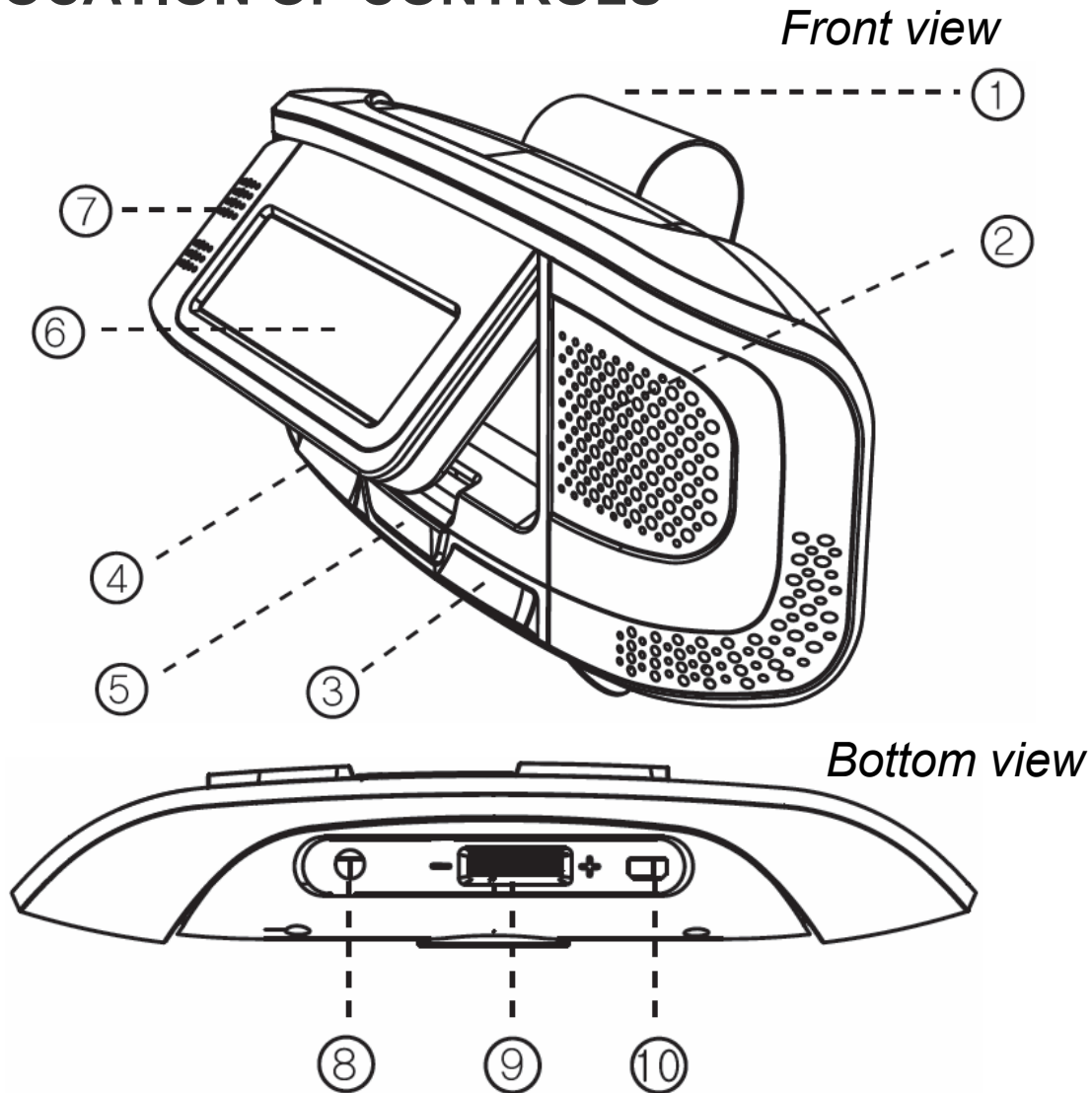

- |                   |                            |
|-------------------|----------------------------|
| 1. Clamp          | 2. Speaker                 |
| 3. TALK button    | 4. END button              |
| 5. HOTLINE button | 6. LCD display             |
| 7. Microphone     | 8. Earphone jack           |
| 9. JOG button     | 10. Mini USB Charging Port |

# GETTING STARTED

## Reading the LCD Screen

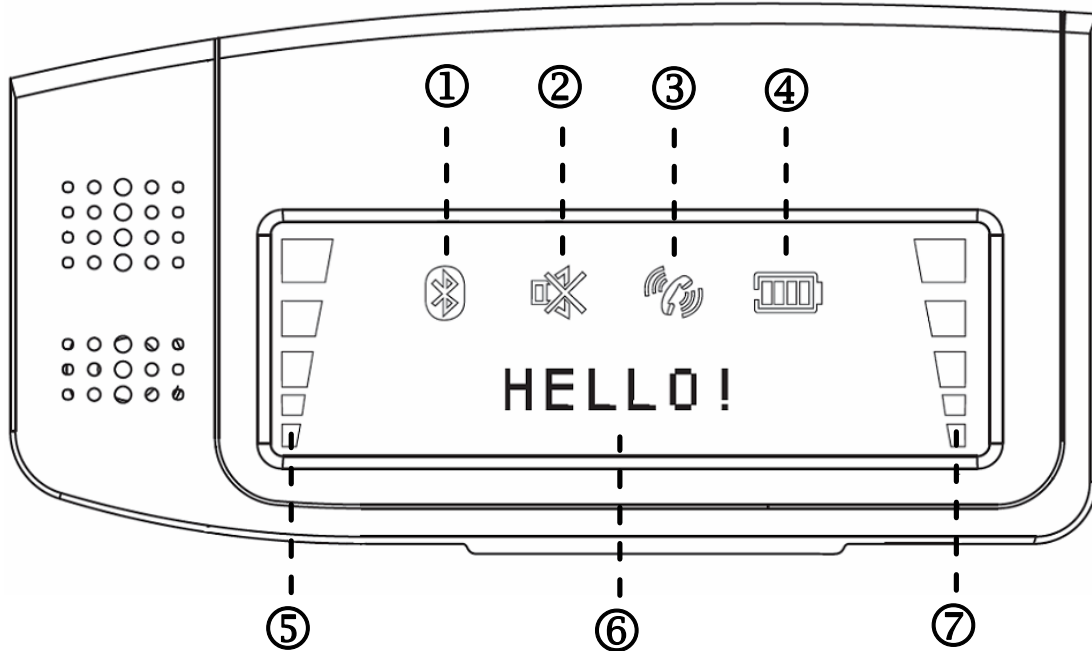

- 1. Bluetooth Indicator
- 2. MIC Mute Indicator
- 3. Call Activation Indicator
- 4. Battery Status Indicator
- 5. Received Signal Strength Indicator (RSSI)
- 6. Status Display
- 7. Volume Level Indicator

## GETTING STARTED

### Charging the Speaker Phone Unit

Fully charge the speaker phone unit by connecting the car charger to the mini-USB port on the bottom right side of the i322.

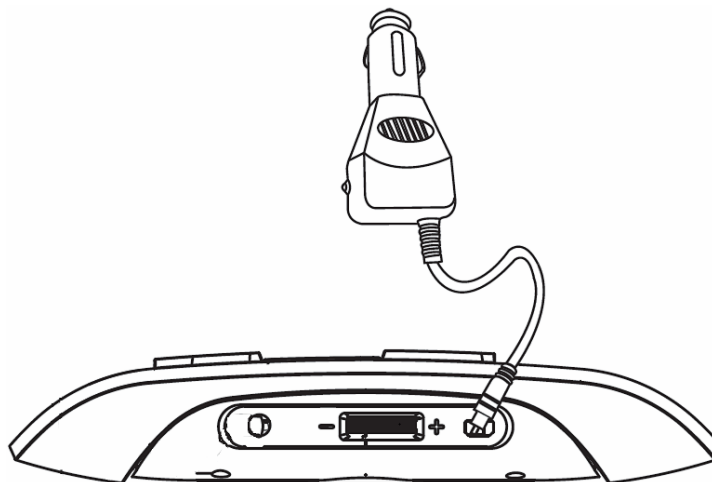

### Turning on the Speaker Phone

The LCD screen is on a hinge allowing it to fold in and out.

1. Fold out the LCD display screen to turn the unit on.
2. The i322 will automatically enter Pairing mode when turned on and will remain in Pairing mode for 60 seconds.
3. To Pair the unit with a mobile phone, follow the instructions for “**Pairing the Speaker Phone**” in this manual.
4. To turn off Pairing mode (to Pair later or if phone has already paired), either wait 60 for Pairing mode to end automatically, or push the **END** (  ) button once.

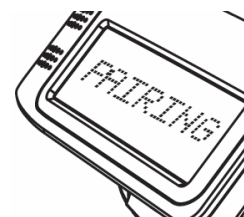
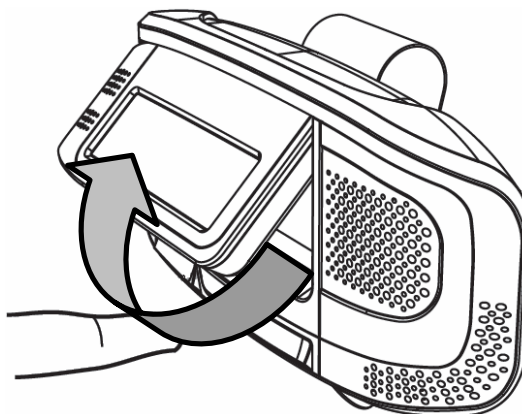

# GETTING STARTED

## Pairing the Speaker Phone

The i322 will enter Pairing mode immediately after the unit is turned on and will remain in Pairing mode for 60 seconds.

1. If the 60 second period when the i322 is automatically in Pairing mode or if the Pairing mode manually ended, press and hold the END (  ) button for three (3) seconds to enter (re-enter) the Pairing mode.
2. If your mobile phone is equipped with *Bluetooth* wireless technology, follow the directions on your mobile phone to set it to **SEARCH** mode.
3. Your phone will find the i322 and will identify it on the LCD screen. To confirm, press **YES** or **OK**.
4. When asked for a **PIN** code or number, enter "0000," (four zeros) and press **YES** or **OK** to confirm.
5. Your mobile phone is now successfully paired with i322.

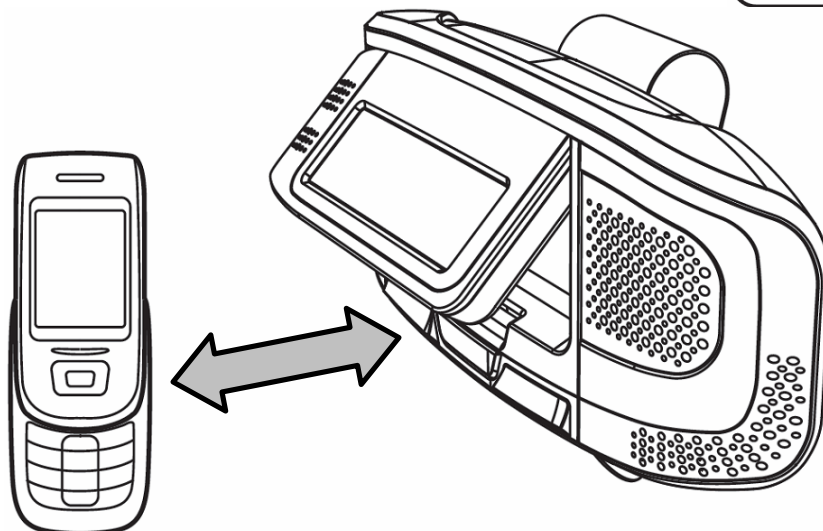
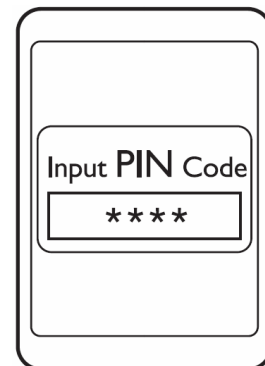
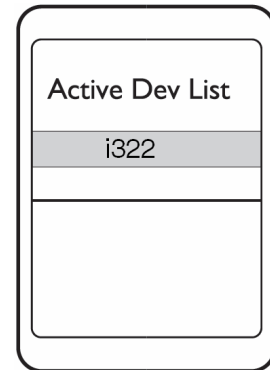

# OPERATIONAL INSTRUCTIONS

## Menu Mode

Please ensure that the unit is unpaired while using the MENU MODE.

1. Press and hold the **JOG (+/-)** button until **MENU MODE** appears on the LCD screen.
2. Move the **JOG (+/-)** button left and right to find the desired function (**RING TONE, PHONE BOOK, HOTLINE**).

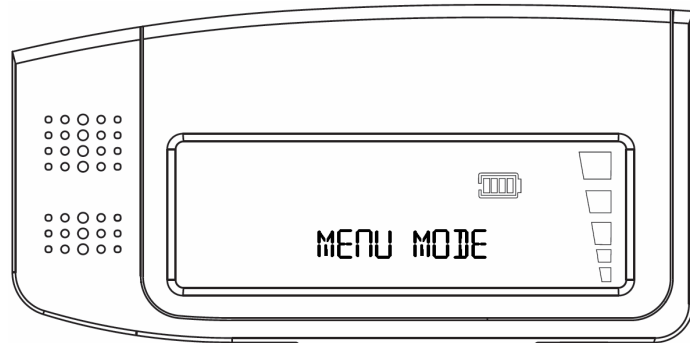

## Setting the Ring Tone

1. In Menu mode, move the **JOG (+/-)** button left or right until **RING TONE** appears on the LCD screen.
2. Press down the **JOG (+/-)** center button to enter the Ring Tone menu.
3. There are three ring tones available (numbered 0-2). Ring tone will sound with each move of the **JOG (+/-)** button.
4. Press and hold the **JOG (+/-)** center button for approximately two (2) seconds to select and exit the Ring Tone menu.

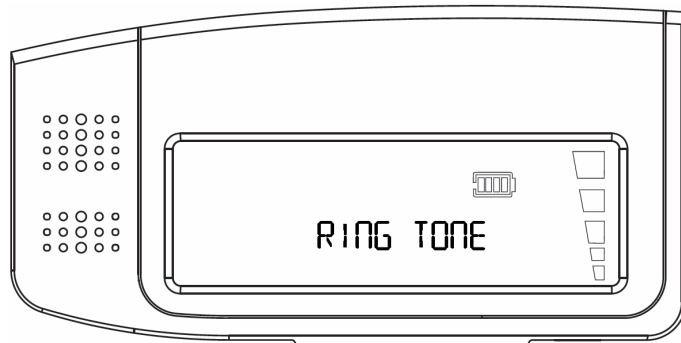

# OPERATIONAL INSTRUCTIONS

## Storing Numbers in the Phone Book

1. In the Menu Mode, move the JOG (+/-) button left or right until **PHONE BOOK** appears on the LCD screen.
2. Once the Phone Book is located, press down the **JOG (+/-)** center button.
3. **INSERT NUM.** will appear briefly on the LCD screen followed by a blinking cursor.
4. Move the **JOG (+/-)** left or right to find the first digit of the phone number you wish to enter.
5. Press down the **JOG (+/-)** center button to save the first digit. A tone will sound and the cursor will advance to the second digit.
6. Repeat this procedure for each digit.
7. When the complete phone number has been entered, press and hold the **JOG (+/-)** center button. A tone will sound and the words **SAVED NUMBER** will appear on the LCD screen. Followed by a blinking cursor.
8. Move the **JOG (+/-)** left or right to choose the letters of the name you wish to enter.
9. Save each letter the same way as digits are saved when entering a phone number.

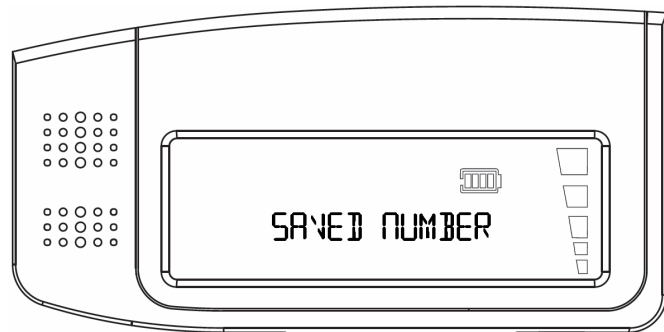
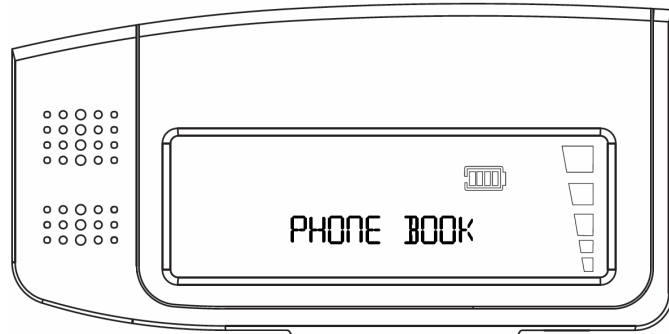



# OPERATIONAL INSTRUCTIONS

## Storing Numbers in the Phone Book-Cont.

10. Once the name is chosen, press and hold the **JOG (+/-)** until the words **SAVED NAME** appear briefly on the LCD screen.

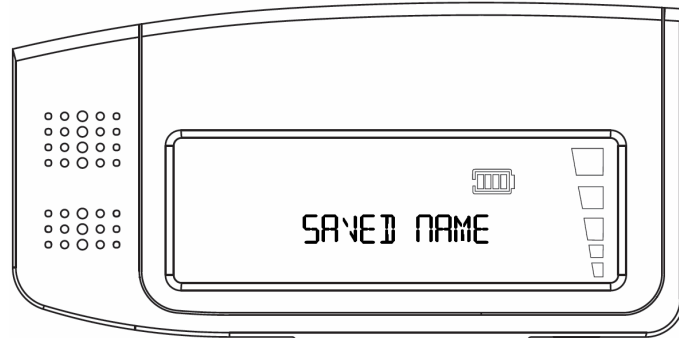

11. You will automatically exit the Phone Book menu once a number and name have been saved.

## Downloading to the Phone Book

If your mobile phone supports Object Push Profile, phone numbers can be transferred from the mobile phone to the i322 by following these instructions:

1. Open the LCD folder while the **END** (📞) button is pressed.
2. The words **OBJECT PUSH** will display on the LCD screen.
3. While i322 is unpaired with the mobile phone, use the mobile phone's instructions for sending numbers.
4. The PIN for i322 is "**0000**."

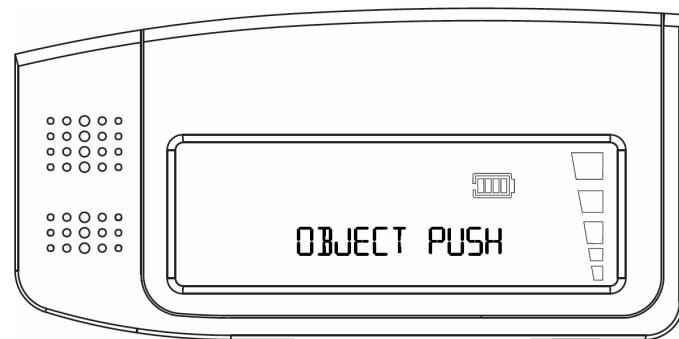



# OPERATING INSTRUCTIONS

## Downloading to the Phone Book-Cont.

5. When the i322 has established connection with your mobile phone, the word **CONNECTED** will appear on the LCD screen.

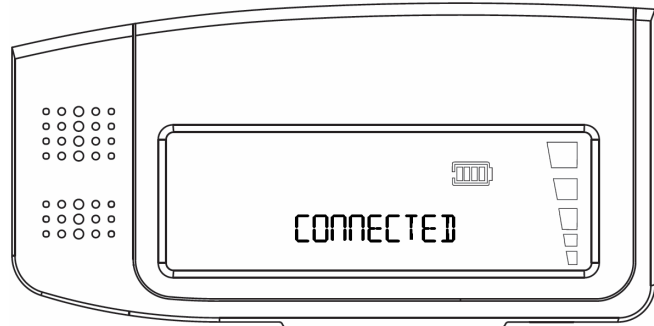

6. The desired number will send automatically and the word **DOWNLOADING** will appear on the LCD screen.

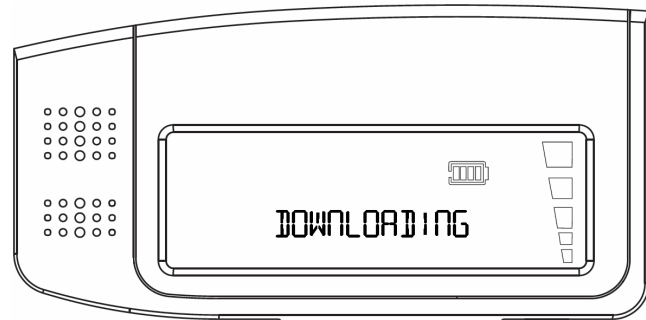

7. When the number has successfully transferred, the word **COMPLETED** will appear briefly on the LCD screen, followed by **OBJECT PUSH**.

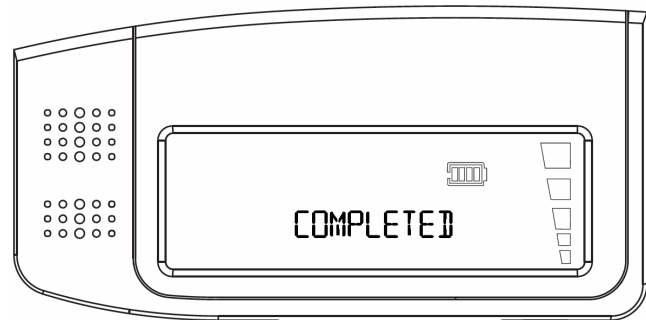

8. After all desired numbers have been transferred, close the LCD folder and follow the pairing instructions in this manual under **Pairing the Speaker Phone**.

# OPERATING INSTRUCTIONS

## Storing Numbers in the Hotline

The Hotline function is for numbers to dial in case of an emergency (close relative or friend).

1. While in the Menu mode, move the **JOG** (+/-) left or right until **HOTLINE** appears on the LCD screen.
2. Follow the above instructions for **Storing Numbers in the Phone Book.**
3. The Hotline menu will close once all names and numbers have been saved in the Hotline.

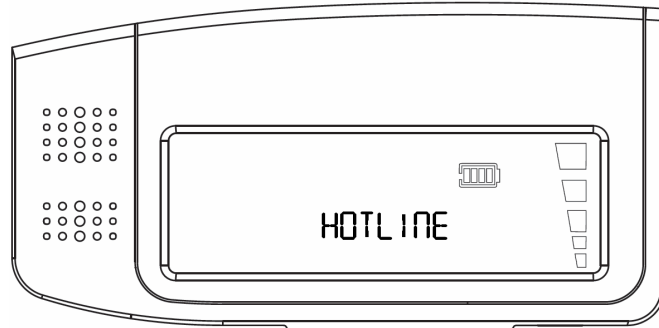

## Deleting Numbers from the Hotline

1. Press the **HOTLINE** button for approximately three (3) seconds.
2. The stored number appears on the LCD screen and the cursor will blink on the last digit.
3. Press the **TALK** (📞) button to delete the digit.
4. Repeat this procedure for each digit.
5. To reset the Hotline number, follow the instructions on **Storing Numbers in the Hotline.**

## Closing the Menu Mode

1. To exit from each Menu mode item (RING TONE, PHONE BOOK, HOTLINE), press the **END** (📞) button.
2. To exit the Menu mode, press the **END** (📞) button again.

**Note:** When using the Menu Mode, the unit should unpaired.

# OPERATING INSTRUCTIONS

## Making a Call

- There are four (4) ways to make a call using the i322: Last Number Redial; Number Dial (from Phone Book); Voice Recognition Dial; and Hotline Dial.

**Note:** If the paired *Bluetooth* phone moves beyond connection range (33 ft.), the i322 must be turned off and turned on again to re-establish the *Bluetooth* connection.

### 1. Last Number Redial

- a. Press the **TALK** () button once immediately after pairing with a mobile phone.
- b. The most recently dialed number from the mobile phone will be dialed out and displayed on the LCD screen.

### 2. Number Dial

- a. Press the **JOG** (+/-) right button.
- b. The last five (5) incoming calls can be displayed by sliding the **JOG** (+/-) left and right buttons.
- c. Numbers stored in the Phone Book can be displayed by sliding the **JOG** (+/-) controller to the left.
- d. When the desired phone number or name is displayed on the LCD screen, press the **TALK** () button to dial the number.

### 3. Voice Recognition Dial

- a. Press the **TALK** () button for approximately three (3) seconds until there is a beep.
- b. Speak the name of the person you wish to call.
- c. The number of that person will be dialed.

# OPERATING INSTRUCTIONS

## Making a Call-Cont.

**Note:** The Voice Recognition Function on your mobile phone must be activated to use this function on the i322. See the instruction manual for your mobile phone for information about voice recognition capability and activation.

### 4. Hotline Dial

- Press the **HOTLINE** button once to dial the stored Hotline number.

## Receiving a Call

1. The unit will ring to indicate that a call is incoming.

2. If the caller's information has been stored in the Phone book, his/her name will appear on the LCD screen.

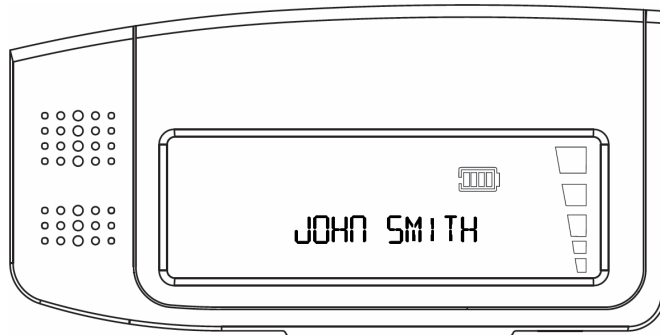

3. If the caller's name has not been stored in the Phone Book, the telephone number will appear on the LCD screen.

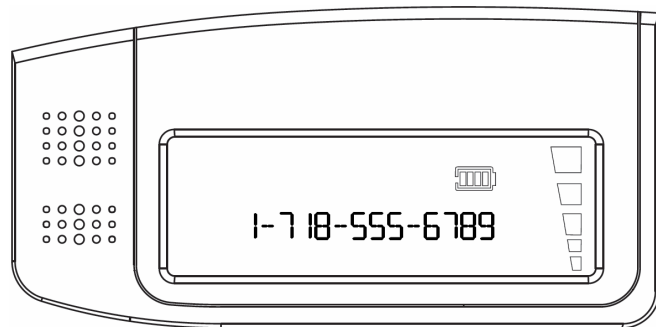

4. Push the **TALK** (📞) button to answer the call.

## Adjusting a Volume



- When on an active call, move the **JOG** (+/-) left and right buttons to adjust the volume level.

# OPERATING INSTRUCTIONS

## Muting the Microphone

1. When on an active call, press the **JOG (+/-)** center button, the microphone will be muted and other part can not hear you.
2. To end the mute function, press **JOG (+/-)** center button one time again.

## Ending / Rejecting a Call

1. When on an active call, press the **END** () button to end the call.
2. When the unit rings to indicate an incoming call, press the **END** () button to reject the call.

## Transferring a Call

- During an active call, press the **TALK** () button to transfer the call from the unit to the mobile phone or from the mobile phone to the unit.

## Call Waiting

When another call comes in during an active call, it can be answered by following these instructions:

1. Press the left **JOG (+/-)** button for two (2) seconds until you hear a beep. This will accept the incoming call and release the current call.
2. Press the right **JOG (+/-)** button for two (2) seconds until you hear a beep. This will accept the incoming call and place the active call on hold.
3. Press the right **JOG (+/-)** button to return to the call on hold.

## Turning off the Speaker Phone

To turn off the Speaker Phone, simply close the LCD folder.

## TROUBLESHOOTING GUIDE

**1. The Speaker Phone does not work with my mobile phone.**

Be certain that your mobile phone is equipped with *Bluetooth* wireless technology. This speaker phone will only work with such mobile phones.

**2. There is interference on the speaker phone.**

The maximum distance for *Bluetooth* wireless communication is 33 feet (10 meters). When this distance is approached, background noise will increase. Also, a poor signal on the mobile phone may contribute to degradation the quality of sound as well.

**3. There is no sound.**

Ensure that the mobile phone is turned on and set up correctly. Be certain that the volume is turned up on the device.

**4. Phone numbers do not transfer from mobile phone to the Phone Book on i322.**

The i322 has Object Push Profile (OPP) to facilitate such transfer, and any connected mobile phone must support OPP in order to transfer numbers between devices.

# SPECIFICATIONS

- Bluetooth spec. v2.0 compliant
- Headset, Hands-free, Object Push Profiles supported
- Bluetooth Class II
- Typically 8 hrs Talk Time
- Typically 200 hrs Stand-by Time
- Rechargeable Lithium Polymer Battery

# iLuv™

**TEL: 516-626-7188**

**FAX: 516-626-7105**

**website: [www.i-Luv.com](http://www.i-Luv.com)**

iLuv is a trademark of jWIN Electronics Corp. Features and specifications are subject to change without prior notification. iPod is a trademark of Apple Computer, Inc. The *Bluetooth* word mark and logos are owned by Bluetooth SIG, Inc. and any use of such marks by jWIN Electronics Corp. is under license. Mobile phone not included in this package.

© 2007 jWIN Electronics Corp. All rights reserved. No portion of this printed material or product enclosed herewith including design, shape and graphics, may be reproduced or transmitted in any form without the expressed written consent of jWIN Electronics Corp. by any means, electronic or mechanical, including photocopying, recording or the use of an information storage and retrieval system. Any unauthorized distribution or reproduction of this printed material or product, or any portion thereof, will be prosecuted to the fullest possible extent of the law.

Printed in China