

**6 10/100/1000T + 2 10/100/1000T/
100/1000 SFP Combo
w/ X-Ring Managed Industrial Switch**

User Manual



SISGM1040-162D



V1.01
September, 2009

Notice

The contents of this manual are based on the table below listing firmware version, software kernel version, and hardware version. If the switch functions are different from the description of the manual, please contact the local sale dealer for more information.

Firmware Version	V1.01
Kernel Version	V1.80
Hardware Version	-----

FCC Warning

This Equipment has been tested and found to comply with the limits for a Class-A digital device, pursuant to Part 15 of the FCC rules. These limits are designed to provide reasonable protection against harmful interference in a residential installation. This equipment generates, uses, and can radiate radio frequency energy. It may cause harmful interference to radio communications if the equipment is not installed and used in accordance with the instructions. However, there is no guarantee that interference will not occur in a particular installation. If this equipment does cause harmful interference to radio or television reception, which can be determined by turning the equipment off and on, the user is encouraged to try to correct the interference by one or more of the following measures:

- Reorient or relocate the receiving antenna.
- Increase the separation between the equipment and receiver.
- Connect the equipment into an outlet on a circuit different from that to which the receiver is connected.
- Consult the dealer or an experienced radio/TV technician for help.

CE Mark Warning

This is a Class-A product. In a domestic environment this product may cause radio interference in which case the user may be required to take adequate measures.

Content

Introduction	1
Benefits	1
Package Contents.....	3
Hardware Description	4
Physical Dimension.....	4
Front Panel	4
Top View	5
LED Indicators	5
Wiring the Power Inputs.....	7
Wiring the Fault Alarm Contact.....	8
Mounting Installation	9
DIN-Rail Mounting.....	9
Wall Mount Plate Mounting	11
Hardware Installation	12
Installation Steps.....	12
Network Application	13
X-Ring Application	14
Coupling Ring Application.....	15
Dual Homing Application.....	16
Console Management	17
Connecting to the Console Port	17
Pin Assignment	17
Login in the Console Interface	18
CLI Management	19

Commands Level.....	20
Commands Set List.....	21
System Commands Set	21
Port Commands Set.....	24
Trunk Commands Set.....	27
VLAN Commands Set.....	28
Spanning Tree Commands Set.....	30
QOS Commands Set	32
IGMP Commands Set.....	33
Mac / Filter Table Commands Set.....	34
SNMP Commands Set.....	34
Port Mirroring Commands Set.....	37
802.1x Commands Set	38
TFTP Commands Set	40
SystemLog, SMTP and Event Commands Set.....	41
SNTP Commands Set.....	42
X-ring Commands Set.....	44
Web-Based Management	45
About Web-based Management	45
Preparing for Web Management.....	45
System Login	46
Main Page	47
System Information	48
IP Configuration	49
DHCP Server—System configuration	50
DHCP Client—Client Entries.....	51
DHCP Server—Port and IP Bindings.....	52

TFTP—Update Firmware	53
TFTP—Restore Configuration	54
TFTP—Backup Configuration	55
System Event Log—Syslog Configuration	56
System Event Log—SMTP Configuration.....	57
System Event Log—Event Configuration.....	59
Fault Relay Alarm	61
SNTP Configuration	62
IP Security.....	65
User Authentication.....	67
Port Statistics	68
Port Control.....	69
Port Trunk	70
Aggregator setting	70
Aggregator Information	72
State Activity	73
Port Mirroring	74
Rate Limiting	75
VLAN configuration	76
VLAN configuration—Port-based VLAN.....	77
802.1Q VLAN.....	79
Rapid Spanning Tree	82
RSTP - System Configuration	82
RSTP - Port Configuration	84
SNMP Configuration	86
System Configuration.....	86

Trap Configuration	88
SNMPV3 Configuration.....	89
QoS Configuration	92
QoS Policy and Priority Type	92
Port Base Priority.....	94
COS Configuration.....	94
TOS Configuration	94
IGMP Configuration	95
X-Ring	97
LLDP Configuration.....	99
Security	100
802.1X/Radius Configuration	100
MAC Address Table.....	104
Factory Default.....	109
Save Configuration	110
System Reboot	111
Troubles shooting	112
Technical Specification.....	113
Appendix	118
10 /100BASE-TX Pin outs.....	118
10/100Base-TX Cable Schematic.....	118
10/100/1000Base-TX Pin outs	119
10/100/1000Base-TX Cable Schematic.....	120
Gigabit Copper/SFP (mini-GBIC) combo port.....	121
Cabling.....	125

Introduction

The 6 10/100/1000T + 2 10/100/1000T/ 100/1000 SFP Combo w/ X-Ring Managed Switch is a cost-effective solution and meets the high reliability requirements demanded by industrial applications. The 6 10/100/1000T + 2 10/100/1000T/ 100/1000 SFP Combo w/ X-Ring Managed Switch can be easily managed through the Web GUI. The fiber port can extend the connection distance to increase network elasticity and performance. It also provides the X-Ring function that can prevent network connection failure.

Benefits

- System Interface/Performance
 - RJ-45 ports support auto MDI/MDI-X function
 - SFP (Mini-GBIC) supports 100/1000 Dual Mode
 - Store-and-Forward switching architecture
 - Back-plane (Switching Fabric): 16Gbps
 - 1Mbits Packet Buffer
 - 8K MAC Address Table
- Power Supply
 - Input Power Isolation design for Telecom application, Pass Hi-Pot test~1.5KV
 - Wide-range Redundant Power Design
- VLAN
 - Port Based VLAN
 - Supports 802.1Q Tag VLAN
 - GVRP
 - Double Tag VLAN (Q in Q)*
- Port Trunk with LACP
- Supports 802.1ab LLDP
- QoS (Quality of Service)
 - Supports IEEE 802.1p Class of Service
 - Per port provides 4 priority queues

- Port Base, Tag Base and Type of Service Priority
- Port Mirror: Monitor traffic in switched networks
 - TX Packet only
 - RX Packet only
 - Both of TX and RX Packet
- Security
 - Port Security: MAC address entries/filter
 - IP Security: IP address security management to prevent unauthorized intruder
 - Login Security: IEEE 802.1X/RADIUS
- IGMP with Query mode for Multi Media Application
- Case/Installation
 - IP-30 Protection
 - DIN Rail and Wall Mount Design
- Spanning Tree
 - Support IEEE 802.1d Spanning Tree
 - Support IEEE 802.1w Rapid Spanning Tree
- X-ring
 - X-ring, Dual Homing, and Couple Ring Topology
 - Provide redundant backup feature and the recovery time below 20ms
- Bandwidth Control
 - Ingress Packet Filter and Egress Rate Limit
 - Broadcast/Multicast Packet Filter Control
- System Event Log
 - System Log Server/Client
 - SMTP e-mail Alert
 - Relay Alarm Output System Events
- SNMP Trap
 - Device cold start
 - Power status
 - Authentication failure
 - X-ring topology changed
 - Port Link up/Link down
- TFTP Firmware Update and System Configuration Restore and Backup

Package Contents

Please refer to the package content list below to verify them against the checklist.

- 6 10/100/1000T + 2 10/100/1000T/ 100/1000 SFP Combo w/ X-Ring Managed Switch
- User manual
- RS-232/RJ-45 cable
- Pluggable Terminal Block
- 2 wall mount plates and 6 screws
- One DIN-Rail (attached on the switch)

Compare the contents of the industrial switch with the standard checklist above. If any item is damaged or missing, please contact the local dealer for service.

Hardware Description

This section describes the Industrial switch’s hardware spec, port, cabling information, and wiring installation.

Physical Dimension

6 10/100/1000T + 2 10/100/1000T/ 100/1000 SFP Combo w/ X-Ring Managed Switch dimension (W x D x H) is **72mm x 105mm x 152mm**

Front Panel

Shown below is the front panel of the 6 10/100/1000T + 2 10/100/1000T/ 100/1000 SFP Combo w/ X-Ring Managed Switch.

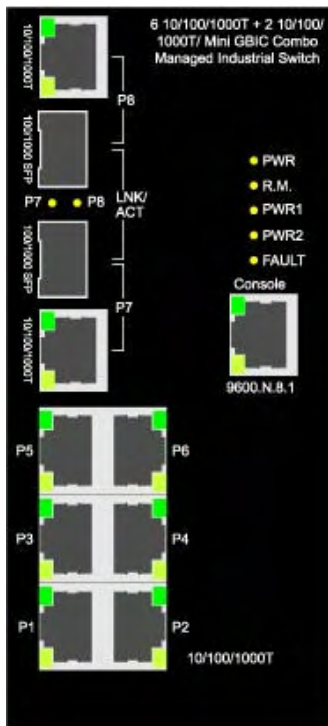

Front Panel of the industrial switch

Top View

The top panel of the 6 10/100/1000T + 2 10/100/1000T/ 100/1000 SFP Combo w/ X-Ring Managed Switch has one terminal block connector for two DC power inputs.

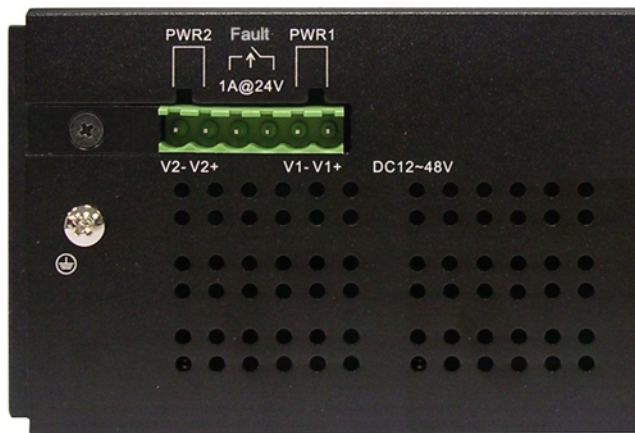

Top Panel of the industrial switch

LED Indicators

There are diagnostic LED indicators located on the front panel of the industrial switch. They provide real-time information of system and optional status. The following table provides description of the LED status and their meanings for the switch.

LED	Status	Description
PWR	Green	System power on
	Off	No power input
R.M.	Green	The industrial switch is the master of the X-Ring group
	Off	The industrial switch is not the ring master in the X-Ring group
PWR1	Green	Power input 1 is active

	Off	Power input 1 is inactive
PWR2	Green	Power input 2 is active
	Off	Power input 2 is inactive
Fault	Red	Power input 1 or 2 is inactive or port link failure (depends on Fault Relay Alarm configuration)
	Off	Power input 1 and 2 are both active, or no power inputs
LNK/ACT (for P7, P8 SFP)	Green	SFP port is linking
	Blinking	Data is transmitting or receiving
	Off	Not connected to network
P1 ~ P8 (RJ-45)	Green (upper LED)	Connected to network
	Blinking (upper LED)	Networking is active
	Off (lower LED)	No connected to network
	Green (lower LED)	The port is operating at speed of 1000M
	Off (lower LED)	The port is disconnected or working at speed of 10/100M

Wiring the Power Inputs

Please follow the steps below to insert the power wire.

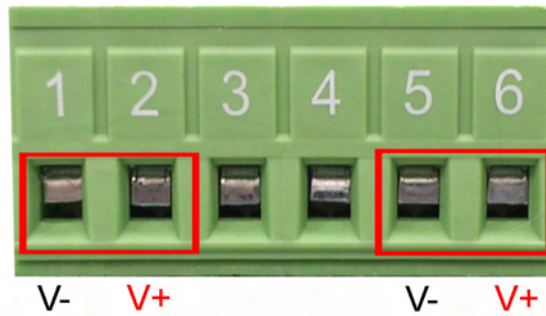

Insert the positive and negative wires into the V+ and V- contacts on the terminal block connector.

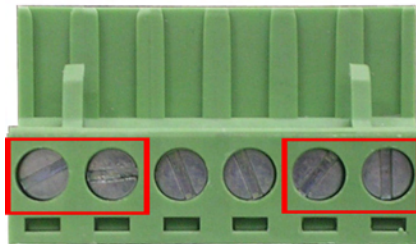

Tighten the wire-clamp screws for preventing the wires from loosing.

Wiring the Fault Alarm Contact

The fault alarm contacts are in the middle of the terminal block connector as the picture shows below. The switch will provide local indication of a power or port failure, if configured, by opening the relay contacts. The following illustration shows an application example for wiring the fault alarm contacts.

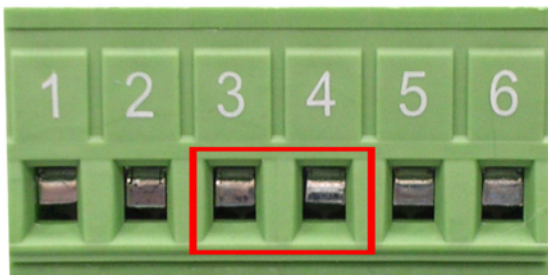

Insert the wires into the fault alarm contacts (No. 3 & 4)

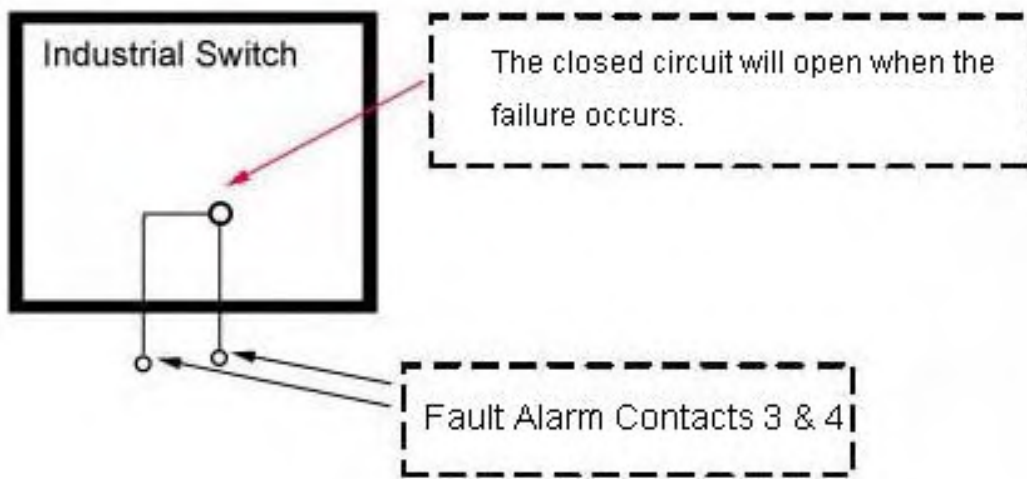

Note *The wire gauge for the terminal block should be in the range between 12~ 24 AWG.*

Mounting Installation

DIN-Rail Mounting

The DIN-Rail is installed on the industrial switch at the factory. If the DIN-Rail is not installed, please see the following pictures to screw the DIN-Rail onto the switch. Follow the steps below to hang the industrial switch.

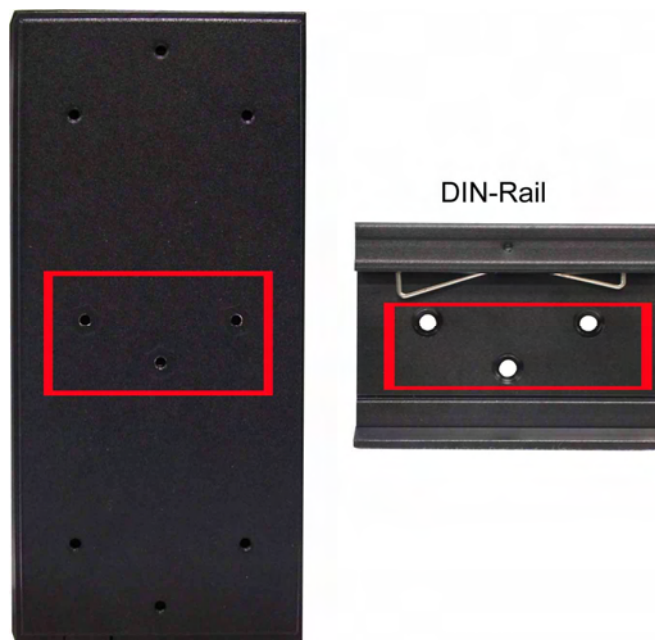

1. First, insert the top of DIN-Rail into the track.

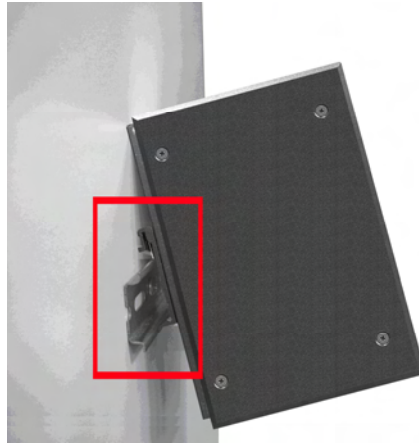

2. Then, lightly push the DIN-Rail into the track.

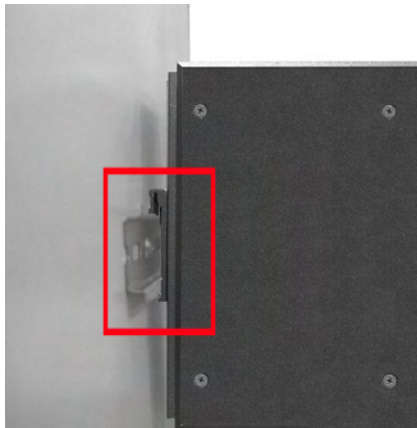

3. Check if the DIN-Rail is tightened on the track or not.
4. To remove the industrial switch from the track, reverse steps above.

Wall Mount Plate Mounting

Follow the steps below to mount the industrial switch with a wall mount plate.

1. Remove the DIN-Rail from the industrial switch; loose the screws to remove the DIN-Rail.
2. Place the wall mount plate on the rear panel of the industrial switch.
3. Use the screws to screw the wall mount plate on the industrial switch.
4. Use the hook holes at the corners of the wall mount plate to hang the industrial switch on the wall.
5. To remove the wall mount plate, reverse the steps above.

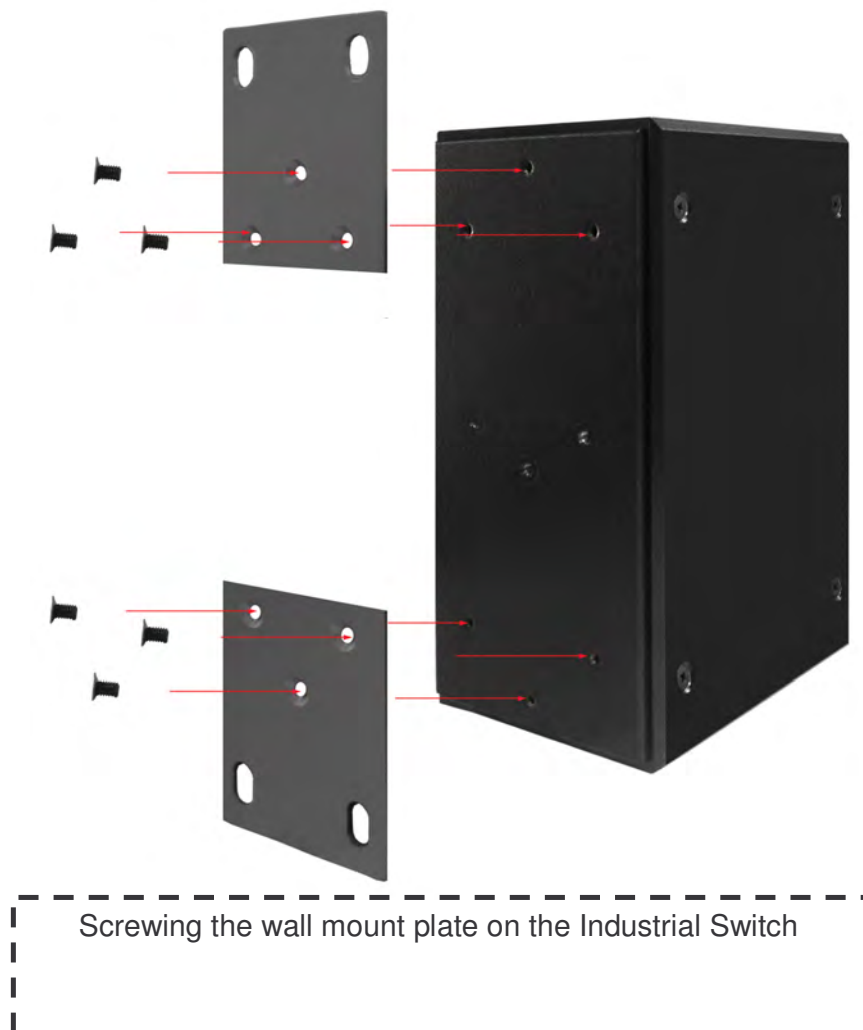

Hardware Installation

This section describes how to physically install the 6 10/100/1000T + 2 10/100/1000T/100/1000 SFP Combo w/ X-Ring Managed Switch.

Installation Steps

1. Unpack the Industrial switch.
2. Check if the DIN-Rail is screwed on the Industrial switch or not. If not, please refer to **DIN-Rail Mounting** section for DIN-Rail installation. If user wants to wall mount the Industrial switch, please refer to **Wall Mount Plate Mounting** section for wall mount plate installation.
3. To hang the Industrial switch on the DIN-Rail track or wall, please refer to the **Mounting Installation** section.
4. Power on the Industrial switch. Please refer to the **Wiring the Power Inputs** section for information about how to wire the power. The power LED on the Industrial switch will light up. Please refer to the **LED Indicators** section for indication of LED lights.
5. Prepare the twisted-pair, straight through Category 5e/above cable for Ethernet connection.
6. Insert one side of RJ-45 cable into the Industrial switch Ethernet port (RJ-45 port) and another side of RJ-45 cable to the network device's Ethernet port (RJ-45 port), e.g. Switch, PC or Server. The UTP port (RJ-45) LED on the industrial switch will light up when the cable is connected with the network device. Please refer to the **LED Indicators** section for LED light indication.
7. When all connections are set and LED lights indicate normal operation, the installation is complete.

Network Application

This section provides some sample applications to guide users. A sample application of the industrial switch is shown as below:

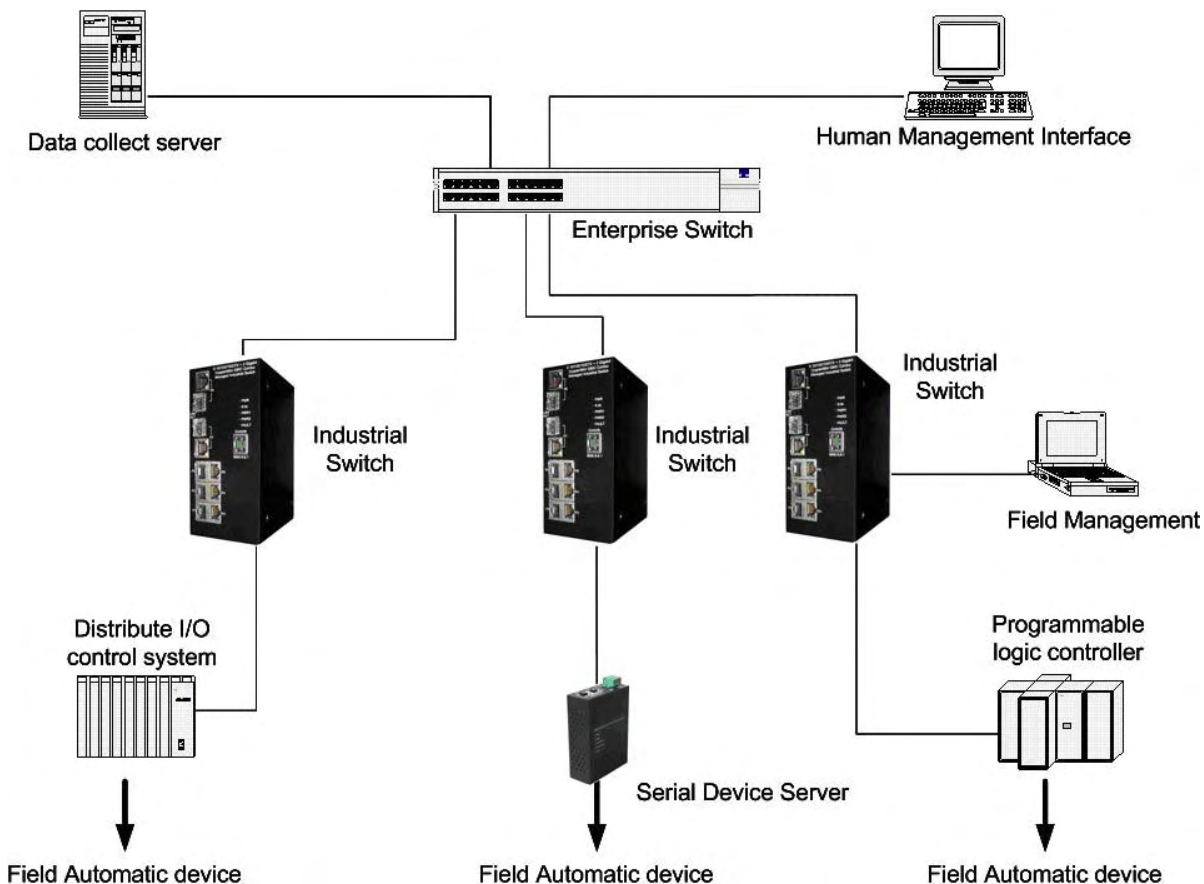

X-Ring Application

The industrial switch supports the X-Ring protocol that can help the network recover from a connection failure within 300ms or less, ensuring network reliability. The X-Ring algorithm is similar to Spanning Tree Protocol (STP)/RSTP algorithm but its recovery time is less than STP/RSTP. The following figure illustrates an X-Ring application.

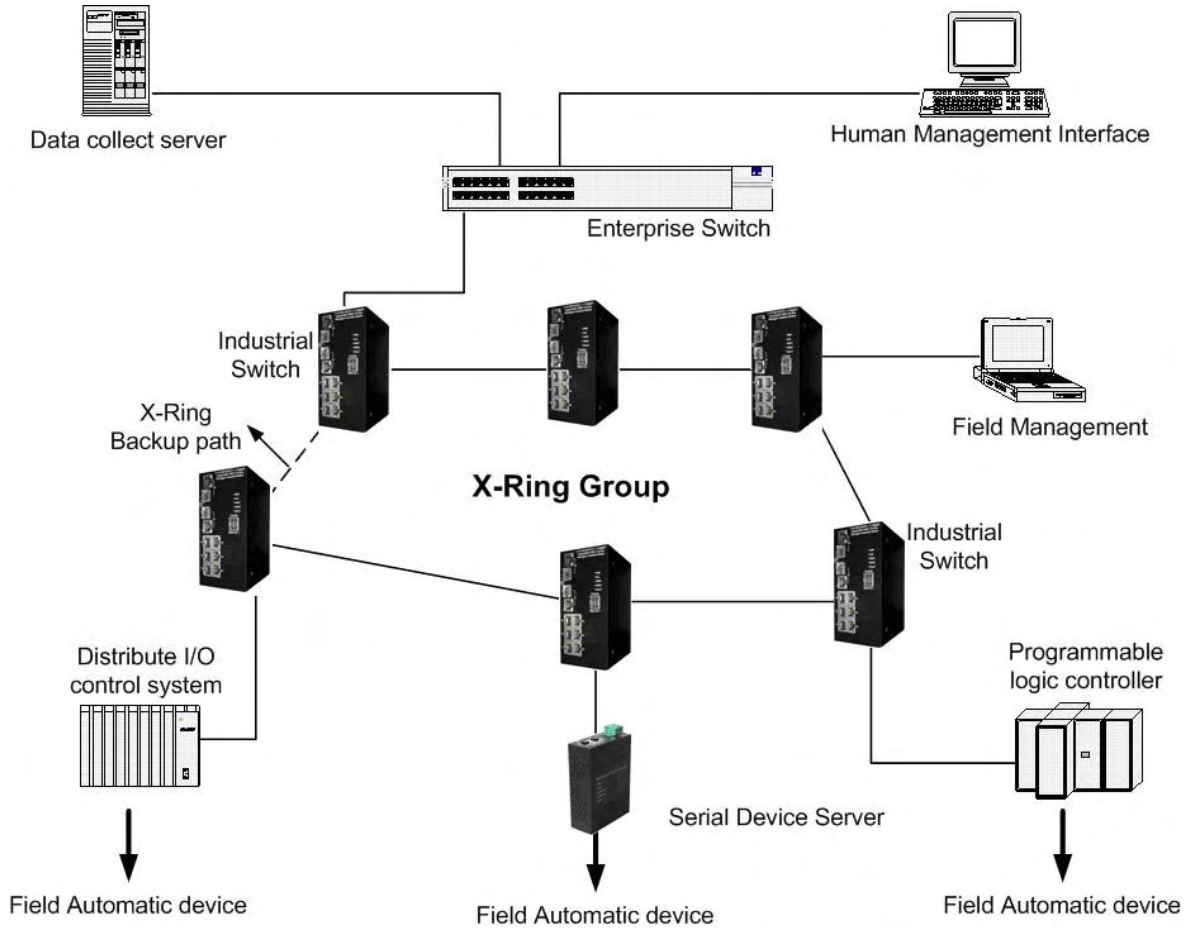

Coupling Ring Application

In the network, there may be more than one X-Ring group. The coupling ring function can connect each X-Ring for redundant backup. It can ensure transmissions between two ring groups do not fail. The following figure is a sample coupling ring application.

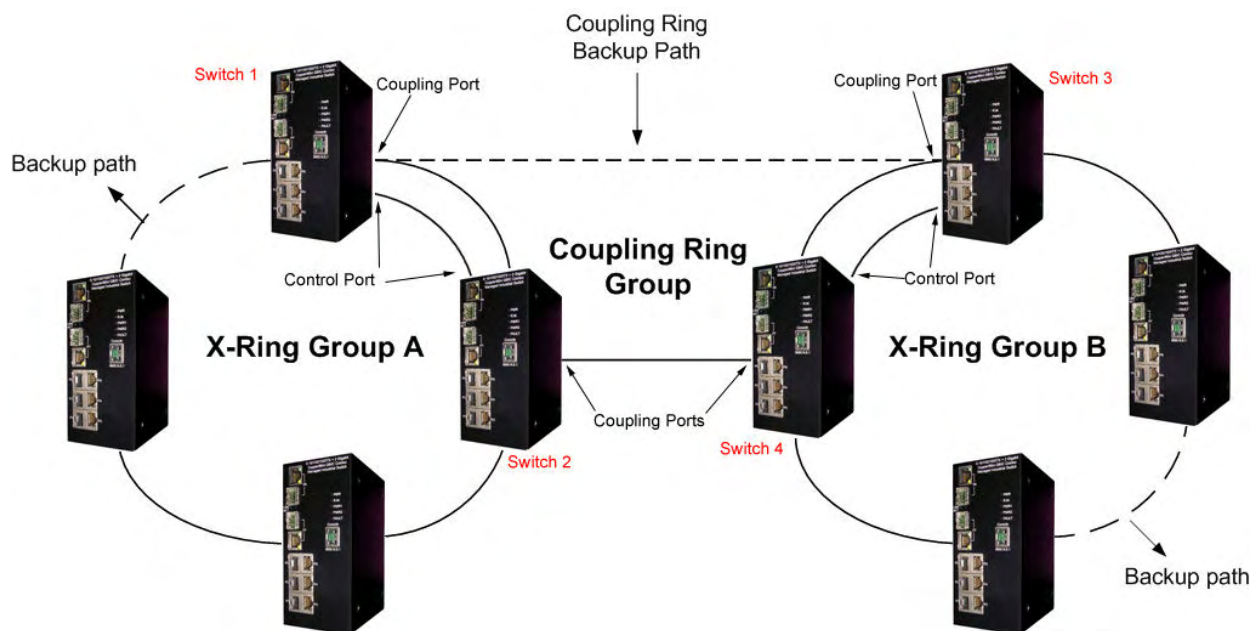

Dual Homing Application

Dual Homing is a function to prevent the connection breaking between an X-Ring group and an upper level/core switch. Assign two ports to be the Dual Homing port that is the backup port in an X-Ring group. The Dual Homing function works only when the X-Ring function is active. Each X-Ring group has only one Dual Homing port.

[NOTE] In a Dual Homing application architecture, the Rapid Spanning Tree protocol of the upper level switches must be enabled.

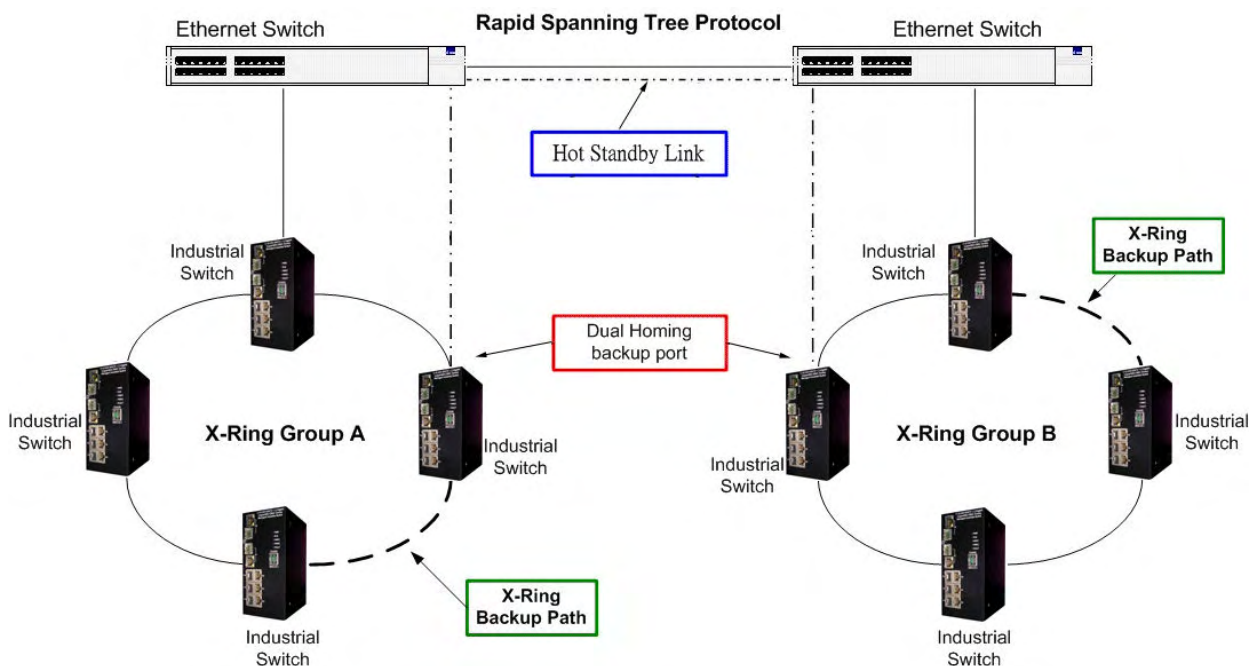

Console Management

Connecting to the Console Port

The supplied cable has an RS-232 connector on one end and an RJ-45 connector on the other. Attach the end with the RS-232 connector to a PC or terminal and the other end with the RJ-45 connector to the console port of the switch. The connected terminal or PC must support the terminal emulation program.

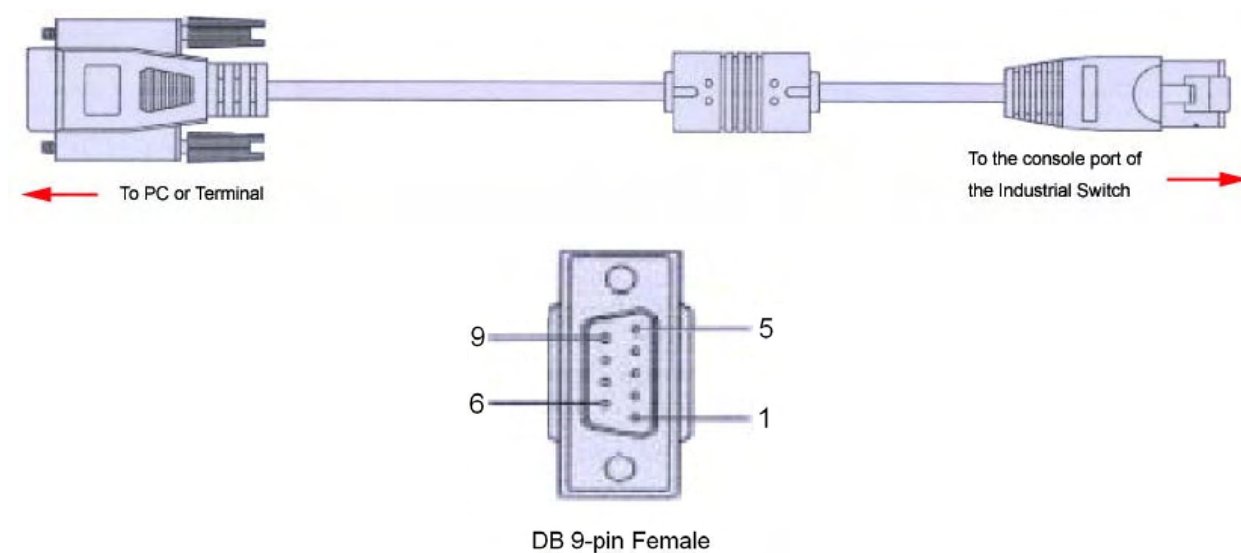

Pin Assignment

DB9 Connector	RJ-45 Connector
NC	1 Orange/White
2	2 Orange
3	3 Green/White
NC	4 Blue
5	5 Blue/White
NC	6 Green
NC	7 Brown/White
NC	8 Brown

Login in the Console Interface

When the connection between Switch and PC is ready, turn on the PC and run a terminal emulation program or **Hyper Terminal** and configure its **communication parameters** to match the following default characteristics of the console port:

Baud Rate: 9600 bps

Data Bits: 8

Parity: none

Stop Bit: 1

Flow control: None

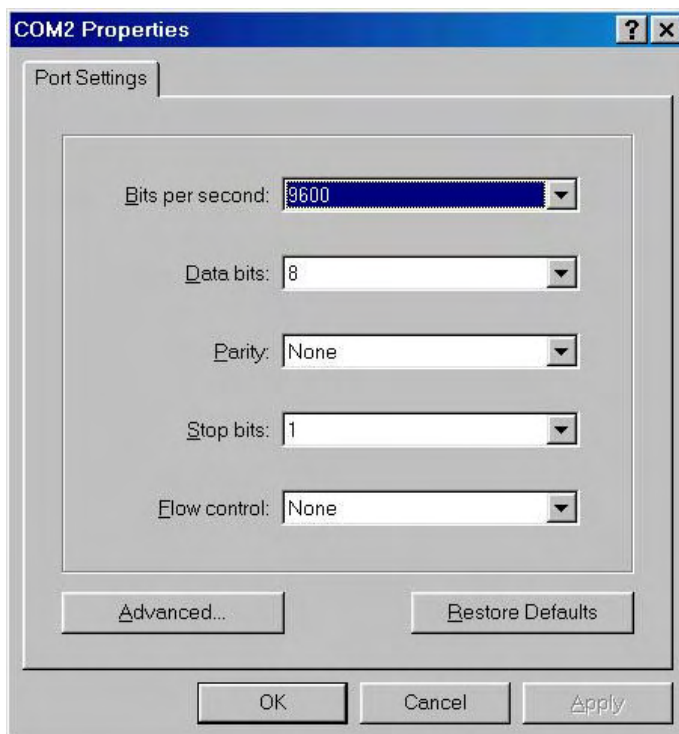

The settings of communication parameters

After finishing the parameter settings, click "OK". When the blank screen shows up, press **Enter** key to bring out the login prompt. Key in the "root"(default value) for the both User name and Password (use **Enter** key to switch), then press **Enter** key and the Main Menu of console management appears. Please see the figure as below.

```
                Welcome to the
6 10/100/1000TX + 2 Gigabit Copper/Mini GBIC Combo Managed Industrial Switch

                User Name :
                Password :
```

Console login interface

CLI Management

The system supports a command line interface management—CLI. After you have logged in the system by typing in user name and password, you will see a command prompt. To enter CLI management interface, enter “**enable**” command.

```
switch>enable
switch#_
```

CLI command interface

The following table lists the CLI commands and description.

Commands Level

Modes	Access Method	Prompt	Exit Method	About This Mode ¹
User EXEC	Begin a session with your switch.	switch>	Enter logout or quit.	The user commands available at the user level are a subset of those available at the privileged level. Use this mode to <ul style="list-style-type: none"> • Perform basic tests. • Displays system information.
Privileged EXEC	Enter the enable command while in user EXEC mode.	switch#	Enter disable to exit.	The privileged command is advance mode Privileged this mode to <ul style="list-style-type: none"> • Displays advance function status • Save configures
Global Configuration	Enter the configure command while in privileged EXEC mode.	switch (config)#	To exit to privileged EXEC mode, enter exit or end	Use this mode to configure parameters that apply to your switch as a whole.
VLAN database	Enter the vlan database command while in privileged	switch (vlan)#	To exit to user EXEC mode, enter exit.	Use this mode to configure VLAN-specific parameters.

	EXEC mode.			
Interface configuration	Enter the interface command (with a specific interface) while in global configuration mode	switch (config-if)#	To exit to global configuration mode, enter exit. To exist to privileged EXEC mode, or end.	Use this mode to configure parameters for the switch and Ethernet ports.

- User EXEC **E**
- Privileged EXEC **P**
- Global configuration **G**
- VLAN database **V**
- Interface configuration **I**

Commands Set List

System Commands Set

Command	Level	Description	Example
show config	E	Show switch configuration	switch> show config
show terminal	P	Show console information	switch# show terminal
write memory	P	Save user configuration into permanent memory (flash rom)	switch# write memory
system name [System Name]	G	Configure system name	switch(config)# system name xxx
system location	G	Set switch system	switch(config)# system location

[System Location]		location string	xxx
system description [System Description]	G	Set switch system description string	switch(config)# system description xxx
system contact [System Contact]	G	Set switch system contact window string	switch(config)# system contact xxx
show system-info	E	Show system information	switch> show system-info
ip address [Ip-address] [Subnet-mask] [Gateway]	G	Configure the IP address of switch	switch(config)# ip address 192.168.16.1 255.255.255.0 192.168.16.254
ip dhcp	G	Enable DHCP client function of switch	switch(config)# ip dhcp
show ip	P	Show IP information of switch	switch# show ip
no ip dhcp	G	Disable DHCP client function of switch	switch(config)# no ip dhcp
reload	G	Halt and perform a cold restart	switch(config)# reload
default	G	Restore to default	switch(config)# default
admin username [Username]	G	Changes a login username. (maximum 10 words)	switch(config)# admin username xxxxxx
admin password [Password]	G	Specifies a password (maximum 10 words)	switch(config)# admin password xxxxxx
show admin	P	Show administrator information	switch# show admin
dhcpserver enable	G	Enable DHCP Server	switch(config)# dhcpserver enable
Dhcpserver disable	G	Disable DHCP Server	switch(config)# no dhcpserver
dhcpserver lowip [Low IP]	G	Configure low IP address for IP pool	switch(config)# dhcpserver lowip 192.168.1.100
dhcpserver highip [High IP]	G	Configure high IP address for IP pool	switch(config)# dhcpserver highip 192.168.1.200

dhcpserver subnetmask [Subnet mask]	G	Configure subnet mask for DHCP clients	switch(config)# dhcpserver subnetmask 255.255.255.0
dhcpserver gateway [Gateway]	G	Configure gateway for DHCP clients	switch(config)# dhcpserver gateway 192.168.1.254
dhcpserver dnsip [DNS IP]	G	Configure DNS IP for DHCP clients	switch(config)# dhcpserver dnsip 192.168.1.1
dhcpserver leasetime [Hours]	G	Configure lease time (in hour)	switch(config)# dhcpserver leasetime 1
dhcpserver ipbinding [IP address]	I	Set static IP for DHCP clients by port	switch(config)# interface fastEthernet 2 switch(config)# dhcpserver ipbinding 192.168.1.1
show dhcpserver configuration	P	Show configuration of DHCP server	switch# show dhcpserver configuration
show dhcpserver clients	P	Show client entries of DHCP server	switch# show dhcpserver clients
show dhcpserver ip-binding	P	Show IP-Binding information of DHCP server	switch# show dhcpserver ip-binding
no dhcpserver	G	Disable DHCP server function	switch(config)# no dhcpserver
security enable	G	Enable IP security function	switch(config)# security enable
security http	G	Enable IP security of HTTP server	switch(config)# security http
security telnet	G	Enable IP security of telnet server	switch(config)# security telnet
security ip [Index(1..10)] [IP Address]	G	Set the IP security list	switch(config)# security ip 1 192.168.1.55
show security	P	Show the information of IP security	switch# show security

no security	G	Disable IP security function	switch(config)# no security
no security http	G	Disable IP security of HTTP server	switch(config)# no security http
no security telnet	G	Disable IP security of telnet server	switch(config)# no security telnet

Port Commands Set

Command	Level	Description	Example
interface fastEthernet [Portid]	G	Choose the port for modification.	switch(config)# interface fastEthernet 2
duplex [full half]	I	Use the duplex configuration command to specify the duplex mode of operation for Fast Ethernet.	switch(config)# interface fastEthernet 2 switch(config-if)# duplex full
speed [10 100 1000 auto]	I	Use the speed configuration command to specify the speed mode of operation for Fast Ethernet., the speed can't be set to 1000 if the port isn't a giga port..	switch(config)# interface fastEthernet 2 switch(config-if)# speed 100
no flowcontrol	I	Disable flow control of interface	switch(config-if)# no flowcontrol
security enable	I	Enable security of interface	switch(config)# interface fastEthernet 2 switch(config-if)# security enable

no security	I	Disable security of interface	switch(config)# interface fastEthernet 2 switch(config-if)# no security
bandwidth type all	I	Set interface ingress limit frame type to 'accept all frame'	switch(config)# interface fastEthernet 2 switch(config-if)# bandwidth type all
bandwidth type broadcast-multicast-flooded-unicast	I	Set interface ingress limit frame type to 'accept broadcast, multicast, and flooded unicast frame'	switch(config)# interface fastEthernet 2 switch(config-if)# bandwidth type broadcast-multicast-flooded-unicast
bandwidth type broadcast-multicast	I	Set interface ingress limit frame type to 'accept broadcast and multicast frame'	switch(config)# interface fastEthernet 2 switch(config-if)# bandwidth type broadcast-multicast
bandwidth type broadcast-only	I	Set interface ingress limit frame type to 'only accept broadcast frame'	switch(config)# interface fastEthernet 2 switch(config-if)# bandwidth type broadcast-only
bandwidth in [Value]	I	Set interface input bandwidth. Rate Range is from 100 kbps to 102400 kbps or to 256000 kbps for giga ports, and zero means no limit.	switch(config)# interface fastEthernet 2 switch(config-if)# bandwidth in 100
bandwidth out [Value]		Set interface output bandwidth. Rate Range is from 100 kbps to 102400 kbps	switch(config)# interface fastEthernet 2 switch(config-if)# bandwidth out 100

		or to 256000 kbps for giga ports, and zero means no limit.	
show bandwidth	I	Show interfaces bandwidth control	switch(config)# interface fastEthernet 2 switch(config-if)# show bandwidth
state [Enable Disable]	I	Use the state interface configuration command to specify the state mode of operation for Ethernet ports. Use the disable form of this command to disable the port.	switch(config)# interface fastEthernet 2 switch(config-if)# state Disable
show interface configuration	I	show interface configuration status	switch(config)# interface fastEthernet 2 switch(config-if)# show interface configuration
show interface status	I	show interface actual status	switch(config)# interface fastEthernet 2 switch(config-if)# show interface status
show interface accounting	I	show interface statistic counter	switch(config)# interface fastEthernet 2 switch(config-if)# show interface accounting
no accounting	I	Clear interface accounting information	switch(config)# interface fastEthernet 2 switch(config-if)# no accounting

Trunk Commands Set

Command	Level	Description	Example
aggregator priority [1~65535]	G	Set port group system priority	switch(config)# aggregator priority 22
aggregator activityport [Group ID] [Port Numbers]	G	Set activity port	switch(config)# aggregator activityport 2
aggregator group [GroupID] [Port-list] lACP workp [Workport]	G	Assign a trunk group with LACP active. [GroupID] :1~4 [Port-list]:Member port list, This parameter could be a port range(ex.1-4) or a port list separate by a comma(ex.2, 3, 6) [Workport]: The amount of work ports, this value could not be less than zero or be large than the amount of member ports.	switch(config)# aggregator group 1 1-4 lACP workp 2 or switch(config)# aggregator group 2 1,4,3 lACP workp 3
aggregator group [GroupID] [Port-list] nolACP	G	Assign a static trunk group. [GroupID] :1~4 [Port-list]:Member port list, This parameter could be a port range(ex.1-4) or a port list separate by a comma(ex.2, 3, 6)	switch(config)# aggregator group 1 2-4 nolACP or switch(config)# aggregator group 1 3,1,2 nolACP

show aggregator	P	Show the information of trunk group	switch# show aggregator 1 or switch# show aggregator 2 or switch# show aggregator 3
no aggregator lacp [GroupID]	G	Disable the LACP function of trunk group	switch(config)# no aggregator lacp 1
no aggregator group [GroupID]	G	Remove a trunk group	switch(config)# no aggregator group 2

VLAN Commands Set

Command	Level	Description	Example
vlan database	P	Enter VLAN configure mode	switch# vlan database
Vlanmode [portbase 802.1q gvrp]	V	To set switch VLAN mode.	switch(vlan)# vlanmode portbase or switch(vlan)# vlanmode 802.1q or switch(vlan)# vlanmode gvrp
no vlan	V	No VLAN	Switch(vlan)# no vlan
Ported based VLAN configuration			
vlan port-based grpname [Group Name] grp-id [GroupID] port [PortNumbers]	V	Add new port based VALN	switch(vlan)# vlan port-based grpname test grp-id 2 port 2-4 or switch(vlan)# vlan port-based grpname test grp-id 2 port 2,3,4
show vlan [GroupID] or show vlan	V	Show VLAN information	switch(vlan)# show vlan 23
no vlan group [GroupID]	V	Delete port base group ID	switch(vlan)# no vlan group 2

IEEE 802.1Q VLAN			
vlan 8021q name [GroupName] vid [VID]	V	Change the name of VLAN group, if the group didn't exist, this command can't be applied.	switch(vlan)# vlan 8021q name test vid 22
vlan 8021q port [PortNumber] access-link untag [UntaggedVID]	V	Assign a access link for VLAN by port, if the port belong to a trunk group, this command can't be applied.	switch(vlan)# vlan 8021q port 3 access-link untag 33
vlan 8021q port [PortNumber] trunk-link tag [TaggedVID List]	V	Assign a trunk link for VLAN by port, if the port belong to a trunk group, this command can't be applied.	switch(vlan)# vlan 8021q port 3 trunk-link tag 2,3,6,99 or switch(vlan)# vlan 8021q port 3 trunk-link tag 3-20
vlan 8021q port [PortNumber] hybrid-link untag tag [TaggedVID List]	V	Assign a hybrid link for VLAN by port, if the port belong to a trunk group, this command can't be applied.	switch(vlan)# vlan 8021q port 3 hybrid-link untag 4 tag 3,6,8 or switch(vlan)# vlan 8021q port 3 hybrid-link untag 5 tag 6-8
vlan 8021q trunk [PortNumber] access-link untag [UntaggedVID]	V	Assign a access link for VLAN by trunk group	switch(vlan)# vlan 8021q trunk 3 access-link untag 33
vlan 8021q trunk [PortNumber] trunk-link tag [TaggedVID List]	V	Assign a trunk link for VLAN by trunk group	switch(vlan)# vlan 8021q trunk 3 trunk-link tag 2,3,6,99 or switch(vlan)# vlan 8021q trunk 3 trunk-link tag 3-20
vlan 8021q trunk [PortNumber] hybrid-link untag tag [UntaggedVID]	V	Assign a hybrid link for VLAN by trunk group	switch(vlan)# vlan 8021q trunk 3 hybrid-link untag 4 tag 3,6,8 or

[TaggedVID List]			switch(vlan)# vlan 8021q trunk 3 hybrid-link untag 5 tag 6-8
show vlan [GroupID] or show vlan	V	Show VLAN information	switch(vlan)# show vlan 23
no vlan group [GroupID]	V	Delete port base group ID	switch(vlan)# no vlan group 2

Spanning Tree Commands Set

Command	Level	Description	Example
spanning-tree enable	G	Enable spanning tree	switch(config)# spanning-tree enable
spanning-tree priority [0~61440]	G	Configure spanning tree priority parameter	switch(config)# spanning-tree priority 32767
spanning-tree max-age [seconds]	G	Use the spanning-tree max-age global configuration command to change the interval between messages the spanning tree receives from the root switch. If a switch does not receive a bridge protocol data unit (BPDU) message from the root switch within this interval, it recomputed the Spanning Tree Protocol (STP) topology.	switch(config)# spanning-tree max-age 15

<p>spanning-tree hello-time [seconds]</p>	<p>G</p>	<p>Use the spanning-tree hello-time global configuration command to specify the interval between hello bridge protocol data units (BPDUs).</p>	<p>switch(config)#spanning-tree hello-time 3</p>
<p>spanning-tree forward-time [seconds]</p>	<p>G</p>	<p>Use the spanning-tree forward-time global configuration command to set the forwarding-time for the specified spanning-tree instances. The forwarding time determines how long each of the listening and learning states last before the port begins forwarding.</p>	<p>switch(config)#spanning-tree forward-time 20</p>
<p>stp-path-cost [1~200000000]</p>	<p>I</p>	<p>Use the spanning-tree cost interface configuration command to set the path cost for Spanning Tree Protocol (STP) calculations. In the event of a loop, spanning tree considers the path cost when selecting an interface to place</p>	<p>switch(config)#interface fastEthernet 2 switch(config-if)#stp-path-cost 20</p>

		into the forwarding state.	
stp-path-priority [Port Priority]	I	Use the spanning-tree port-priority interface configuration command to configure a port priority that is used when two switches tie for position as the root switch.	switch(config)# interface fastEthernet 2 switch(config-if)# stp-path-priority 128
stp-admin-p2p [Auto True False]	I	Admin P2P of STP priority on this interface.	switch(config)# interface fastEthernet 2 switch(config-if)# stp-admin-p2p Auto
stp-admin-edge [True False]	I	Admin Edge of STP priority on this interface.	switch(config)# interface fastEthernet 2 switch(config-if)# stp-admin-edge True
stp-admin-non-stp [True False]	I	Admin NonSTP of STP priority on this interface.	switch(config)# interface fastEthernet 2 switch(config-if)# stp-admin-non-stp False
show spanning-tree	E	Displays a summary of the spanning-tree states.	switch> show spanning-tree
no spanning-tree	G	Disable spanning-tree.	switch(config)# no spanning-tree

QOS Commands Set

Command	Level	Description	Example
qos policy [weighted-fair strict]	G	Select QOS policy scheduling	switch(config)# qos policy weighted-fair

qos prioritytype [port-based cos-only tos-only cos-first tos-first]	G	Setting of QOS priority type	switch(config)# qos prioritytype
qos priority portbased [Port] [lowest low middle high]	G	Configure Port-based Priority	switch(config)# qos priority portbased 1 low
qos priority cos [Priority][lowest low middle high]	G	Configure COS Priority	switch(config)# qos priority cos 0 middle
qos priority tos [Priority][lowest low middle high]	G	Configure TOS Priority	switch(config)# qos priority tos 3 high
show qos	P	Displays the information of QoS configuration	Switch# show qos
no qos	G	Disable QoS function	switch(config)# no qos

IGMP Commands Set

Command	Level	Description	Example
igmp enable	G	Enable IGMP snooping function	switch(config)# igmp enable
igmp-query auto	G	Set IGMP query to auto mode	switch(config)# igmp-query auto
igmp-query force	G	Set IGMP query to force mode	switch(config)# igmp-query force
show igmp configuration	P	Displays the details of an IGMP configuration.	switch# show igmp configuration
show igmp multi	P	Displays the details of an IGMP snooping entries.	switch# show igmp multi
no igmp	G	Disable IGMP snooping function	switch(config)# no igmp

no igmp-query	G	Disable IGMP query	switch# no igmp-query
----------------------	----------	--------------------	------------------------------

Mac / Filter Table Commands Set

Command	Level	Description	Example
mac-address-table static hwaddr [MAC]	I	Configure MAC address table of interface (static).	switch(config)# interface fastEthernet 2 switch(config-if)# mac-address-table static hwaddr 000012345678
mac-address-table filter hwaddr [MAC]	G	Configure MAC address table(filter)	switch(config)# mac-address-table filter hwaddr 000012348678
show mac-address-table	P	Show all MAC address table	switch# show mac-address-table
show mac-address-table static	P	Show static MAC address table	switch# show mac-address-table static
show mac-address-table filter	P	Show filter MAC address table.	switch# show mac-address-table filter
no mac-address-table static hwaddr [MAC]	I	Remove an entry of MAC address table of interface (static)	switch(config)# interface fastEthernet 2 switch(config-if)# no mac-address-table static hwaddr 000012345678
no mac-address-table filter hwaddr [MAC]	G	Remove an entry of MAC address table (filter)	switch(config)# no mac-address-table filter hwaddr 000012348678
no mac-address-table	G	Remove dynamic entry of MAC address table	switch(config)# no mac-address-table

SNMP Commands Set

Command	Level	Description	Example
---------	-------	-------------	---------

snmp system-name [System Name]	G	Set SNMP agent system name	switch(config)# snmp system-name I2switch
snmp system-location [System Location]	G	Set SNMP agent system location	switch(config)# snmp system-location lab
snmp system-contact [System Contact]	G	Set SNMP agent system contact	switch(config)# snmp system-contact where
snmp agent-mode [v1v2c v3 v1v2cv3]	G	Select the agent mode of SNMP	switch(config)# snmp agent-mode v1v2cv3
snmp community-strings [Community] right [RO/RW]	G	Add SNMP community string.	switch(config)# snmp community-strings public right rw
snmp-server host [IP address] community [Community-string] trap-version [v1 v2c]	G	Configure SNMP server host information and community string	switch(config)# snmp-server host 192.168.1.50 community public trap-version v1 (remove) Switch(config)# no snmp-server host 192.168.1.50
snmpv3 context-name [Context Name]	G	Configure the context name	switch(config)# snmpv3 context-name Test
snmpv3 user [User Name] group [Group Name] password [Authentication Password] [Privacy Password]	G	Configure the userprofile for SNMPV3 agent. Privacy password could be empty.	switch(config)# snmpv3 user test01 group G1 password AuthPW PrivPW
snmpv3 access context-name [Context Name] group [Group Name]	G	Configure the access table of SNMPV3 agent	switch(config)# snmpv3 access context-name Test group G1 security-level AuthPriv match-rule Exact views V1 V1 V1

security-level [NoAuthNoPriv AuthNoPriv AuthPriv] match-rule [Exact Prifix] views [Read View Name] [Write View Name] [Notify View Name]			
snmpv3 mibview view [View Name] type [Excluded Included] sub-oid [OID]	G	Configure the mibview table of SNMPV3 agent	switch(config)# snmpv3 mibview view V1 type Excluded sub-oid 1.3.6.1
show snmp	P	Show SNMP configuration	switch# show snmp
no snmp community-strings [Community]	G	Remove the specified community.	switch(config)# no snmp community-strings public
no snmp-server host [Host-address]	G	Remove the SNMP server host.	switch(config)# no snmp-server host 192.168.1.50
no snmpv3 user [User Name]	G	Remove specified user of SNMPv3 agent.	switch(config)# no snmpv3 user Test
no snmpv3 access context-name [Context Name] group [Group Name] security-level [NoAuthNoPriv AuthNoPriv AuthPriv]	G	Remove specified access table of SNMPv3 agent.	switch(config)# no snmpv3 access context-name Test group G1 security-level AuthPriv match-rule Exact views V1 V1 V1

match-rule [Exact Prefix] views [Read View Name] [Write View Name] [Notify View Name]			
no snmpv3 mibview view [View Name] type [Excluded Included] sub-oid [OID]	G	Remove specified mibview table of SNMPV3 agent.	switch(config)# no snmpv3 mibview view V1 type Excluded sub-oid 1.3.6.1

Port Mirroring Commands Set

Command	Level	Description	Example
monitor rx	G	Set RX destination port of monitor function	switch(config)# monitor rx
monitor tx	G	Set TX destination port of monitor function	switch(config)# monitor tx
show monitor	P	Show port monitor information	switch# show monitor
monitor [RX TX Both]	I	Configure source port of monitor function	switch(config)# interface fastEthernet 2 switch(config-if)# monitor RX
show monitor	I	Show port monitor information	switch(config)# interface fastEthernet 2 switch(config-if)# show monitor
no monitor	I	Disable source port of monitor function	switch(config)# interface fastEthernet 2

			switch(config-if)#no monitor
--	--	--	------------------------------

802.1x Commands Set

Command	Level	Description	Example
8021x enable	G	Use the 802.1x global configuration command to enable 802.1x protocols.	switch(config)# 8021x enable
8021x system radiusip [IP address]	G	Use the 802.1x system radius IP global configuration command to change the radius server IP.	switch(config)# 8021x system radiusip 192.168.1.1
8021x system serverport [port ID]	G	Use the 802.1x system server port global configuration command to change the radius server port	switch(config)# 8021x system serverport 1812
8021x system accountport [port ID]	G	Use the 802.1x system account port global configuration command to change the accounting port	switch(config)# 8021x system accountport 1813
8021x system sharedkey [ID]	G	Use the 802.1x system share key global configuration command to change the shared key value.	switch(config)# 8021x system sharedkey 123456
8021x system nasid [words]	G	Use the 802.1x system nasid global configuration command to change	switch(config)# 8021x system nasid test1

		the NAS ID	
8021x misc quietperiod [sec.]	G	Use the 802.1x misc quiet period global configuration command to specify the quiet period value of the switch.	switch(config)# 8021x misc quietperiod 10
8021x misc txperiod [sec.]	G	Use the 802.1x misc TX period global configuration command to set the TX period.	switch(config)# 8021x misc txperiod 5
8021x misc supptimeout [sec.]	G	Use the 802.1x misc supp timeout global configuration command to set the supplicant timeout.	switch(config)# 8021x misc supptimeout 20
8021x misc servertimeout [sec.]	G	Use the 802.1x misc server timeout global configuration command to set the server timeout.	switch(config)# 8021x misc servertimeout 20
8021x misc maxrequest [number]	G	Use the 802.1x misc max request global configuration command to set the MAX requests.	switch(config)# 8021x misc maxrequest 3
8021x misc reauthperiod [sec.]	G	Use the 802.1x misc reauth period global configuration command to set the reauth period.	switch(config)# 8021x misc reauthperiod 3000

8021x portstate [disable reject accept authorize]	I	Use the 802.1x port state interface configuration command to set the state of the selected port.	switch(config)# interface fastethernet 3 switch(config-if)# 8021x portstate accept
show 8021x	E	Displays a summary of the 802.1x properties and also the port sates.	switch> show 8021x
no 8021x	G	Disable 802.1x function	switch(config)# no 8021x

TFTP Commands Set

Command	Level	Description	Defaults Example
backup flash:backup_cfg	G	Save configuration to TFTP and need to specify the IP of TFTP server and the file name of image.	switch(config)# backup flash:backup_cfg
restore flash:restore_cfg	G	Get configuration from TFTP server and need to specify the IP of TFTP server and the file name of image.	switch(config)# restore flash:restore_cfg
upgrade flash:upgrade_fw	G	Upgrade firmware by TFTP and need to specify the IP of TFTP server and the file name of image.	switch(config)# upgrade flash:upgrade_fw

SystemLog, SMTP and Event Commands Set

Command	Level	Description	Example
systemlog ip [IP address]	G	Set System log server IP address.	switch(config)# systemlog ip 192.168.1.100
systemlog mode [client server both]	G	Specified the log mode	switch(config)# systemlog mode both
show systemlog	E	Displays system log.	Switch> show systemlog
show systemlog	P	Show system log client & server information	switch# show systemlog
no systemlog	G	Disable systemlog function	switch(config)# no systemlog
smtp enable	G	Enable SMTP function	switch(config)# smtp enable
smtp serverip [IP address]	G	Configure SMTP server IP	switch(config)# smtp serverip 192.168.1.5
smtp authentication	G	Enable SMTP authentication	switch(config)# smtp authentication
smtp account [account]	G	Configure authentication account	switch(config)# smtp account User
smtp password [password]	G	Configure authentication password	switch(config)# smtp password
smtp rcptemail [Index] [Email address]	G	Configure Rcpt e-mail Address	switch(config)# smtp rcptemail 1 Alert@test.com
show smtp	P	Show the information of SMTP	switch# show smtp
no smtp	G	Disable SMTP function	switch(config)# no smtp
event device-cold-start [Systemlog SMTP Both]	G	Set cold start event type	switch(config)# event device-cold-start both
event authentication-failure	G	Set Authentication failure event type	switch(config)# event authentication-failure both

[Systemlog SMTP Both]			
event ring-topology-change [Systemlog SMTP Both]	G	Set X-ring topology changed event type	switch(config)# event ring-topology-change both
event systemlog [Link-UP Link-Down Both]	I	Set port event for system log	switch(config)# interface fastethernet 3 switch(config-if)# event systemlog both
event smtp [Link-UP Link-Down Both]	I	Set port event for SMTP	switch(config)# interface fastethernet 3 switch(config-if)# event smtp both
show event	P	Show event selection	switch# show event
no event device-cold-start	G	Disable cold start event type	switch(config)# no event device-cold-start
no event authentication-failure	G	Disable Authentication failure event type	switch(config)# no event authentication-failure
no event ring-topology-change	G	Disable X-ring topology changed event type	switch(config)# no event ring-topology-change
no event systemlog	I	Disable port event for system log	switch(config)# interface fastethernet 3 switch(config-if)# no event systemlog
no event smtp	I	Disable port event for SMTP	switch(config)# interface fastethernet 3 switch(config-if)# no event smtp
show systemlog	P	Show system log client & server information	switch# show systemlog

SNTP Commands Set

Command	Level	Description	Example
---------	-------	-------------	---------

sntp enable	G	Enable SNTP function	switch(config)# sntp enable
sntp daylight	G	Enable daylight saving time, if SNTP function is inactive, this command can't be applied.	switch(config)# sntp daylight
sntp daylight-period [Start time] [End time]	G	Set period of daylight saving time, if SNTP function is inactive, this command can't be applied. Parameter format: [yyyymmdd-hh:mm]	switch(config)# sntp daylight-period 20060101-01:01 20060202-01-01
sntp daylight-offset [Minute]	G	Set offset of daylight saving time, if SNTP function is inactive, this command can't be applied.	switch(config)# sntp daylight-offset 3
sntp ip [IP]	G	Set SNTP server IP, if SNTP function is inactive, this command can't be applied.	switch(config)# sntp ip 192.169.1.1
sntp timezone [Timezone]	G	Set timezone index, use 'show sntp timzezone' command to get more information of index number	switch(config)# sntp timezone 22
show sntp	P	Show SNTP information	switch# show sntp
show sntp timezone	P	Show index number of	switch# show sntp timezone

		time zone list	
no sntp	G	Disable SNTP function	switch(config)# no sntp
no sntp daylight	G	Disable daylight saving time	switch(config)# no sntp daylight

X-ring Commands Set

Command	Level	Description	Example
ring enable	G	Enable X-ring	switch(config)# ring enable
ring master	G	Enable ring master	switch(config)# ring master
ring couplering	G	Enable couple ring	switch(config)# ring couplering
ring dualhoming	G	Enable dual homing	switch(config)# ring dualhoming
ring ringport [1st Ring Port] [2nd Ring Port]	G	Configure 1st/2nd Ring Port	switch(config)# ring ringport 7 8
ring couplingport [Coupling Port]	G	Configure Coupling Port	switch(config)# ring couplingport 1
ring controlport [Control Port]	G	Configure Control Port	switch(config)# ring controlport 2
ring homingport [Dual Homing Port]	G	Configure Dual Homing Port	switch(config)# ring homingport 3
show ring	P	Show the information of X - Ring	switch# show ring
no ring	G	Disable X-ring	switch(config)# no ring
no ring master	G	Disable ring master	switch(config)# no ring master
no ring couplering	G	Disable couple ring	switch(config)# no ring couplering
no ring dualhoming	G	Disable dual homing	switch(config)# no ring dualhoming

Web-Based Management

This section introduces the configuration and functions of the Web-Based management.

About Web-based Management

On the CPU board of the switch there is an embedded HTML web site residing in flash memory. This offers advanced management features and allow users to manage the switch from anywhere on the network through a standard browser such as Microsoft Internet Explorer.

The Web-Based Management supports Internet Explorer 6.0 or later version. It utilizes Java Applets for reducing network bandwidth consumption, enhancing access speed and presenting an easy viewing screen.

Preparing for Web Management

Before using web management, install the industrial switch on the network and make sure that any one of the PCs on the network can connect with the industrial switch through the web browser. The industrial switch default value of IP, subnet mask, username and password are as follows:

- IP Address: **192.168.1.77**
- Subnet Mask: **255.255.255.0**
- Default Gateway: **192.168.1.254**
- User Name: **root**
- Password: **root**

System Login

1. Launch the Internet Explorer on the PC
2. Key in “http:// +” the IP address of the switch”, and then Press “**Enter**”.



3. The login screen will appear right after
4. Key in the user name and password. The default user name and password are the same as “**root**”
5. Press “**Enter**” or “**OK**”, and then the home screen of the Web-based management appears as below:



Login screen

Main Page

The home page of the Web-based screen mainly consists of a treeview control item. For more details about each function, please click the '+' symbol of each node to expand the tree structure.



- Open all
- Main Page
- System
- Port
- Protocol
- Security
- Factory Default
- Save Configuration
- System Reboot

Welcome to the

6 10/100/1000TX + 2 Gigabit Copper/Mini GBIC Combo Managed Industrial Switch

Main interface

System Information

Assign the system name, location and view the system information.

- **System Name:** Assign the name of switch. The maximum length is 64 bytes.
- **System Description:** Displays the description of switch. This column is read only; cannot be modified.
- **System Location:** Assign the switch physical location. The maximum length is 64 bytes.
- **System Contact:** Enter the name of contact person or organization.
- **Firmware Version:** Displays the switch’s firmware version.
- **Kernel Version:** Displays the kernel software version.
- **MAC Address:** Displays the unique hardware address assigned by manufacturer (default).

System Information

System Name	<input type="text"/>
System Description	6 10/100/1000TX + 2 Gigabit Copper/Mini GBIC Combo Managed
System Location	<input type="text"/>
System Contact	<input type="text"/>

Apply Help

Firmware Version	v1.18
Kernel Version	v1.61
MAC Address	000F380131E7

System information interface

IP Configuration

User can configure the IP Settings and DHCP client function

- **DHCP Client:** Enable or disable the DHCP client function. When DHCP client function is enabled, the industrial switch will be assigned an IP address from the network DHCP server. The default IP address will be replaced with an IP address which is assigned by the DHCP server. After user click “**Apply**” button, a pop-up dialog show up. It is to inform the user that when the DHCP client is enabled, the current IP will lose and user should find the new IP on the DHCP server.
- **IP Address:** Assign the IP address that the network is using. If DHCP client function is enabled, then user needn’t assign the IP address manually. Instead, the network DHCP server will assign the IP address for the industrial switch and display it in this column. The default IP is 192.168.1.77
- **Subnet Mask:** Assign the subnet mask of the IP address. If DHCP client function is enabled, and then user needn’t assign the subnet mask manually
- **Gateway:** Assign the network gateway for the industrial switch. The default gateway is 192.168.1.254
- **DNS1:** Assign the primary DNS IP address.
- **DNS2:** Assign the secondary DNS IP address.
- And then, click 

IP Configuration

DHCP Client : ▾

IP Address	<input type="text" value="192.168.16.1"/>
Subnet Mask	<input type="text" value="255.255.255.0"/>
Gateway	<input type="text" value="192.168.16.254"/>
DNS1	<input type="text" value="0.0.0.0"/>
DNS2	<input type="text" value="0.0.0.0"/>

IP configuration interface

DHCP Server—System configuration

The system provides the DHCP server function. Enable the DHCP server function, the switch system will be a DHCP server.

- **DHCP Server:** Enable or Disable the DHCP Server function. Enable – the switch will be the DHCP server on your local network.
- **Low IP Address:** the dynamic IP assign range. Low IP address is the beginning of the dynamic IP assigns range. For example: dynamic IP assign range is from 192.168.1.100 ~ 192.168.1.200. 192.168.1.100 will be the Low IP address.
- **High IP Address:** the dynamic IP assign range. High IP address is the end of the dynamic IP assigns range. For example, dynamic IP assign range is from 192.168.1.100 ~ 192.168.1.200. Therefore, 192.168.1.200 is the High IP address.
- **Subnet Mask:** The dynamic IP assign range subnet mask.
- **Gateway:** The gateway in your network.
- **DNS:** Domain Name Server IP Address in your network.
- **Lease Time (sec):** It is the time period that system will reset the dynamic IP assignment to ensure the dynamic IP won't have been occupied for a long time; otherwise the server won't know that the dynamic IP is idle.
- And then, click

DHCP Server - System Configuration

DHCP Server : <input type="button" value="Disable"/>	
Low IP Address	192.168.16.100
High IP Address	192.168.16.200
Subnet Mask	255.255.255.0
Gateway	192.168.16.254
DNS	0.0.0.0
Lease Time (sec)	86400

DHCP Server Configuration interface

DHCP Client—Client Entries

When the DHCP server function is active, the system will collect the DHCP client information and display it here.

DHCP Server - Client Entries

System Configuration	Client Entries	Port and IP Binding					
<table><thead><tr><th>IP addr</th><th>Client ID</th><th>Type</th><th>Status</th><th>Lease</th></tr></thead></table>			IP addr	Client ID	Type	Status	Lease
IP addr	Client ID	Type	Status	Lease			

DHCP Client Entries interface

DHCP Server—Port and IP Bindings

You can assign the specific IP address that is the IP in the dynamic IP assign range to the specific port. When the device is connected to the port and asks for dynamic IP assigning, the system will assign the IP address that has been assigned to the connected device.

DHCP Server - Port and IP Binding

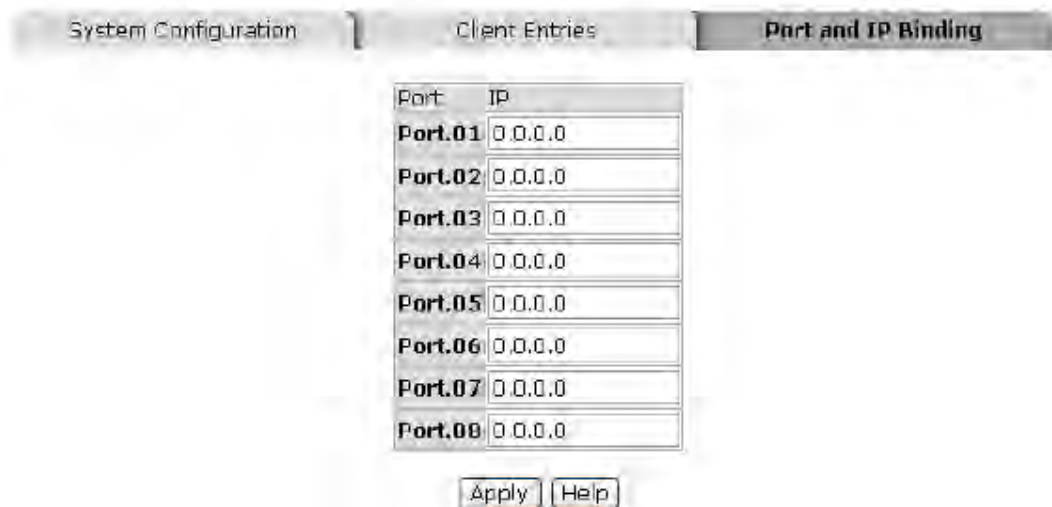

Port and IP Bindings interface

TFTP—Update Firmware

TFTP allows the user to update the switch firmware remotely, via the network. Before updating, make sure you have your TFTP server ready and the firmware image is on the TFTP server.

1. **TFTP Server IP Address:** Fill in your TFTP server IP.
2. **Firmware File Name:** the name of firmware image.
3. Click **Apply**.



TFTP - Update Firmware

Update Firmware | Restore Configuration | Backup Configuration

TFTP Server IP Address: 192.168.16.2

Firmware File Name: image.bin

Apply Help

Update Firmware interface

TFTP—Restore Configuration

You can restore the switch configuration from the TFTP server, but you must put the image file on TFTP server first. The switch will then download the flash image.

1. **TFTP Server IP Address:** Fill in the TFTP server IP.
2. **Restore File Name:** Fill in the correct restore file name.
3. Click **Apply**.

TFTP - Restore Configuration

Update Firmware | **Restore Configuration** | Backup Configuration

TFTP Server IP Address: 192.168.16.2

Restore File Name: data.bin

Apply Help

Restore Configuration interface

TFTP—Backup Configuration

You can save the current switch configuration from the switch to TFTP server, then go to the TFTP restore configuration page to restore the switch configuration.

1. **TFTP Server IP Address:** Fill in the TFTP server IP.
2. **Backup File Name:** Fill the file name.
3. Click **Apply**.

TFTP - Backup Configuration

Update Firmware | Restore Configuration | **Backup Configuration**

TFTP Server IP Address	192.168.16.2
Backup File Name	data.bin

Apply Help

Backup Configuration interface

System Event Log—Syslog Configuration

Configure the system events that you want to record and the system log server IP.

1. **Syslog Client Mode:** Select the system log mode – client only, server only, or both S/C.
2. **System Log Server IP Address:** Assigned the system log server IP.
3. Click **Reload** to refresh the events log.
4. Click **Clear** to clear all current events log.
5. After configuring, click **Apply**.

System Event Log - Syslog Configuration

The screenshot displays the 'Syslog Configuration' interface. At the top, there are three tabs: 'Syslog Configuration' (selected), 'SMTP Configuration', and 'Event Configuration'. Below the tabs, there are two configuration fields: 'Syslog Client Mode' with a dropdown menu set to 'Both' and an 'Apply' button, and 'Syslog Server IP Address' with a text input field containing '0.0.0.0'. Below these fields is a large text area containing a log list with two entries: '1 Jan 1 01:13:01 - System Log Enable!' and '2 Jan 1 01:13:01 - System Log Server IP: 0.0.0.0'. At the bottom of the interface, there is a 'Page 1' indicator, a 'Reload' button, and a 'Clear' button.

Syslog Configuration interface

System Event Log—SMTP Configuration

You can set up the mail server IP, mail account, account password, and forwarded email account for receiving the event alert.

1. **Email Alert:** enable or disable the email alert function.
2. **SMTP Server IP:** set up the mail server IP address (when **Email Alert** enabled, this function will then be available).
3. **Sender:** key in a complete email address, e.g. switch101@123.com, to identify where the event log comes from.
4. **Authentication:** mark the check box to enable and configure the email account and password for authentication (when **Email Alert** enabled, this function will then be available).
5. **Mail Account:** set up the email account, e.g. johnadmin, to receive the alert. It must be an existing email account on the mail server, which you had set up in **SMTP Server IP Address** column.
6. **Password:** The email account password.
7. **Confirm Password:** reconfirm the password.
8. **Rcpt e-mail Address 1 ~ 6:** you can assign up to 6 e-mail accounts also to receive the alert.
9. Click .

System Event Log - SMTP Configuration

[Syslog Configuration](#) | **SMTP Configuration** | [Event Configuration](#)

E-mail Alert: ▾

SMTP Server IP Address :	<input type="text" value="192.168.16.5"/>
Sender :	<input type="text" value="switch101@123.com"/>
<input checked="" type="checkbox"/> Authentication	
Mail Account :	<input type="text" value="johnadmin"/>
Password :	<input type="password" value="****"/>
Confirm Password :	<input type="password" value="****"/>
Rcpt e-mail Address 1 :	<input type="text" value="supervisor@123.com"/>
Rcpt e-mail Address 2 :	<input type="text"/>
Rcpt e-mail Address 3 :	<input type="text"/>
Rcpt e-mail Address 4 :	<input type="text"/>
Rcpt e-mail Address 5 :	<input type="text"/>
Rcpt e-mail Address 6 :	<input type="text"/>

SMTP Configuration interface

System Event Log—Event Configuration

You can select the system log events and SMTP events. When selected events occur, the system will send out the log information. Also, per port log and SMTP events can be selected. After configuring, Click **Apply**.

- **System event selection:** 4 selections – Device cold start, Device warm start, SNMP Authentication Failure, and X-ring topology change. Mark the checkbox to select the event. When selected events occur, the system will issue the logs.
 - **Device cold start:** When the device executes cold start action, the system will issue a log event.
 - **Device warm start:** When the device executes warm start, the system will issue a log event.
 - **Authentication Failure:** When the SNMP authentication fails, the system will issue a log event.
 - **X-ring topology change:** When the X-ring topology has changed, the system will issue a log event.
- **Port event selection:** Select the per port events and per port SMTP events. It has 3 selections – Link UP, Link Down, and Link UP & Link Down. Disable means no event is selected.
 - **Link UP:** the system will issue a log message when port connection is up only.
 - **Link Down:** the system will issue a log message when port connection is down only.
 - **Link UP & Link Down:** the system will issue a log message when port connection is up and down.

System Event Log - Event Configuration

Syslog Configuration | SMTP Configuration | **Event Configuration**

System event selection

Event Type	Syslog	SMTP
Device cold start	<input type="checkbox"/>	<input type="checkbox"/>
Device warm start	<input type="checkbox"/>	<input type="checkbox"/>
Authentication Failure	<input type="checkbox"/>	<input type="checkbox"/>
X-Ring topology change	<input type="checkbox"/>	<input type="checkbox"/>

Port event selection

Port	Syslog	SMTP
Port.01	Disable <input type="button" value="v"/>	Disable <input type="button" value="v"/>
Port.02	Disable <input type="button" value="v"/>	Disable <input type="button" value="v"/>
Port.03	Disable <input type="button" value="v"/>	Disable <input type="button" value="v"/>
Port.04	Disable <input type="button" value="v"/>	Disable <input type="button" value="v"/>
Port.05	Disable <input type="button" value="v"/>	Disable <input type="button" value="v"/>
Port.06	Disable <input type="button" value="v"/>	Disable <input type="button" value="v"/>
Port.07	Disable <input type="button" value="v"/>	Disable <input type="button" value="v"/>
Port.08	Disable <input type="button" value="v"/>	Disable <input type="button" value="v"/>

Event Configuration interface

Fault Relay Alarm

The Fault Relay Alarm function provides the mechanism for warning when power or port faults are detected. There is a set of relay contacts in the switch, and the contacts are closed when either no fault alarms are configured, or the system is normal. With the check boxes unchecked, the system won't change the status of the relay when a fault occurs. Please see the segment of **'Wiring the Fault Alarm Contact'** for reference. With both power input 1 and power input 2 installed and the check boxes of power 1/power 2 ticked, the FAULT LED indicator will then be possible to light up when any one of the power fault occurs. As for the Port Link Down/Broken detection, the FAULT LED indicator will light up when the port fault occurs.

- **Power Failure:** Tick the check box to enable the function of lighting up the **FAULT** LED on the panel when power fails.
- **Port Link Down/Broken:** Tick the check box to enable the function of lighting up **FAULT** LED on the panel when Ports' states are link down or broken.

Fault Relay Alarm

Power Failure	
<input type="checkbox"/> Power 1	<input type="checkbox"/> Power 2
Port Link Down/Broken	
<input type="checkbox"/> Port 1	<input type="checkbox"/> Port 2
<input type="checkbox"/> Port 3	<input type="checkbox"/> Port 4
<input type="checkbox"/> Port 5	<input type="checkbox"/> Port 6
<input type="checkbox"/> Port 7	<input type="checkbox"/> Port 8
<input type="button" value="Apply"/>	

Fault Relay Alarm interface

SNTP Configuration

You can configure the SNTP (Simple Network Time Protocol) settings. The SNTP allows you to synchronize switch clocks via the Internet.

1. **SNTP Client:** Enable or disable SNTP function to get the time from the SNTP server.
2. **Daylight Saving Time:** Enable or disable daylight saving time function. When daylight saving time is enabled, you need to configure the daylight saving time period.
3. **UTC Timezone:** Set the switch location time zone. The following table lists the different location time zones for your reference.

Local Time Zone	Conversion from UTC	Time at 12:00 UTC
November Time Zone	- 1 hour	11am
Oscar Time Zone	-2 hours	10 am
ADT - Atlantic Daylight	-3 hours	9 am
AST - Atlantic Standard EDT - Eastern Daylight	-4 hours	8 am
EST - Eastern Standard CDT - Central Daylight	-5 hours	7 am
CST - Central Standard MDT - Mountain Daylight	-6 hours	6 am
MST - Mountain Standard PDT - Pacific Daylight	-7 hours	5 am
PST - Pacific Standard ADT - Alaskan Daylight	-8 hours	4 am
ALA - Alaskan Standard	-9 hours	3 am

HAW - Hawaiian Standard	-10 hours	2 am
Nome, Alaska	-11 hours	1 am
CET - Central European FWT - French Winter MET - Middle European MEWT - Middle European Winter SWT - Swedish Winter	+1 hour	1 pm
EET - Eastern European, USSR Zone 1	+2 hours	2 pm
BT - Baghdad, USSR Zone 2	+3 hours	3 pm
ZP4 - USSR Zone 3	+4 hours	4 pm
ZP5 - USSR Zone 4	+5 hours	5 pm
ZP6 - USSR Zone 5	+6 hours	6 pm
WAST - West Australian Standard	+7 hours	7 pm
CCT - China Coast, USSR Zone 7	+8 hours	8 pm
JST - Japan Standard, USSR Zone 8	+9 hours	9 pm
EAST - East Australian Standard GST Guam Standard, USSR Zone 9	+10 hours	10 pm
IDLE - International Date Line NZST - New Zealand	+12 hours	Midnight

Standard		
NZT - New Zealand		

4. **SNTP Sever URL:** Set the SNTP server IP address.
5. **Daylight Saving Period:** Set up the Daylight Saving beginning time and Daylight Saving ending time. Both will be different in every year.
6. **Daylight Saving Offset (mins):** Set up the offset time.
7. **Switch Timer:** Displays the switch current time.
8. Click .

SNTP Configuration

SNTP Client : Disable ▼

Daylight Saving Time : Disable ▼

LTC Timezone	<input type="text" value="(GMT)Greenwich Mean Time: Dublin, Edinburgh, Lisbon, London"/>	
SNTP Server URL	<input type="text" value="0.0.0.0"/>	
Switch Timer	<input type="text"/>	
Daylight Saving Period	<input type="text" value="20040101 00:00"/>	<input type="text" value="20040101 00:00"/>
Daylight Saving Offset(mins)	<input type="text" value="0"/>	

SNTP Configuration interface

IP Security

The IP security function allows the user to assign 10 specific IP addresses that have permission to access the switch through the web browser for managing the switch.

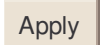
- **IP Security Mode:** When this option is enabled, the **Enable HTTP Server** and **Enable Telnet Server** Check boxes will then be available.
- **Enable HTTP Server:** When this check box is checked, the IP addresses among Security IP1 ~ IP10 will be allowed to access via HTTP service.
- **Enable Telnet Server:** When checked, the IP addresses among Security IP1 ~ IP10 will be allowed to access via Telnet service.
- **Security IP 1 ~ 10:** Assign up to 10 specific IP addresses. Only these 10 IP address can access and manage the switch through the Web browser
- And then, click  button to apply the configuration

[NOTE] Remember to execute the “Save Configuration” action, otherwise the new configuration will be lost when switch power is turned off.

IP Security

IP Security Mode: **Enable** ▼

- Enable HTTP Server
- Enable Telnet Server

Security IP1	0.0.0.0
Security IP2	0.0.0.0
Security IP3	0.0.0.0
Security IP4	0.0.0.0
Security IP5	0.0.0.0
Security IP6	0.0.0.0
Security IP7	0.0.0.0
Security IP8	0.0.0.0
Security IP9	0.0.0.0
Security IP10	0.0.0.0

IP Security interface

User Authentication

Here you can change login user name and password for management security.

1. **User name:** Key in the new user name (The default is “root”)
2. **Password:** Key in the new password (The default is “root”)
3. **Confirm password:** Re-type the new password
4. And then, click 

User Authentication

User Name :	<input type="text" value="root"/>
New Password :	<input type="password" value="••••"/>
Confirm Password :	<input type="password" value="••••"/>

User Authentication interface

Port Statistics

The following information provides the current port statistic information.

- **Port:** The port number.
- **Type:** Displays the current speed of connection to the port.
- **Link:** The status of linking—'Up' or 'Down'.
- **State:** It's set by Port Control. When the state is disabled, the port will not transmit or receive any packet.
- **Tx Good Packet:** The counts of transmitting good packets via this port.
- **Tx Bad Packet:** The counts of transmitting bad packets (including undersize [less than 64 bytes], oversize, CRC Align errors, fragments and jabbers packets) via this port.
- **Rx Good Packet:** The counts of receiving good packets via this port.
- **Rx Bad Packet:** The counts of receiving bad packets (including undersize [less than 64 bytes], oversize, CRC error, fragments and jabbers) via this port.
- **Tx Abort Packet:** The aborted packet while transmitting.
- **Packet Collision:** The counts of collision packet.
- **Packet Dropped:** The counts of dropped packet.
- **Rx Bcast Packet:** The counts of broadcast packet.
- **Rx Mcast Packet:** The counts of multicast packet.
- Click button to clean all counts.

Port Statistics

Port	Type	Link	State	Tx Good Packet	Tx Bad Packet	Rx Good Packet	Rx Bad Packet	Tx Abort Packet	Packet Collision	Packet Dropped	RX Bcast Packet	RX Mcast Packet
Port.01	1000TX	Down	Enable	0	0	0	0	0	0	0	0	0
Port.02	1000TX	Down	Enable	0	0	0	0	0	0	0	0	0
Port.03	1000TX	Up	Enable	1123	0	27460	0	0	0	0	20454	4841
Port.04	1000TX	Down	Enable	0	0	0	0	0	0	0	0	0
Port.05	1000TX	Down	Enable	0	0	0	0	0	0	0	0	0
Port.06	1000TX	Down	Enable	0	0	0	0	0	0	0	0	0
Port.07	1GTx/mGBIC	Down	Enable	0	0	0	0	0	0	0	0	0
Port.08	1GTx/mGBIC	Down	Enable	0	0	0	0	0	0	0	0	0

Port Statistics interface

Port Control

In Port control, you can view every port status that depended on user setting and the negotiation result.

1. **Port:** select the port that you want to configure.
2. **State:** Current port status. The port can be set to disable or enable mode. If the port setting is disable then will not receive or transmit any packet.
3. **Negotiation:** set auto negotiation status of port.
4. **Speed:** set the port link speed.
5. **Duplex:** set full-duplex or half-duplex mode of the port.
6. **Flow Control:** set flow control function as **Enable** or **Disable** in Full Duplex mode. The default value is **Enable**.
7. **Security:** When its state is 'On' that means this port accepts only one MAC address which was configured to be a static MAC address.
8. Click **Apply** .

Port Control

Port	State	Negotiation	Speed	Duplex	Flow Control	Security
Port.01						
Port.02	Enable	Auto	1000	Full	Enable	Off
Port.03						
Port.04						

Apply Help



Port	Group ID	Type	Link	State	Negotiation	Speed Config	Duplex Actual	Flow Control Config	Flow Control Actual	Security
Port.01	N/A	1000TX	Down	Enable	Auto	1G Full	N/A	Enable	N/A	OFF
Port.02	N/A	1000TX	Down	Enable	Auto	1G Full	N/A	Enable	N/A	OFF
Port.03	N/A	1000TX	Down	Enable	Auto	1G Full	N/A	Enable	N/A	OFF
Port.04	N/A	1000TX	Down	Enable	Auto	1G Full	N/A	Enable	N/A	OFF
Port.05	N/A	1000TX	Up	Enable	Auto	1G Full	100 Full	Enable	ON	OFF
Port.06	N/A	1000TX	Down	Enable	Auto	1G Full	N/A	Enable	N/A	OFF
Port.07	N/A	1GTX/mGBIC	Down	Enable	Auto	1G Full	N/A	Enable	N/A	OFF
Port.08	N/A	1GTX/mGBIC	Down	Enable	Auto	1G Full	N/A	Enable	N/A	OFF

Port Control interface

Port Trunk

The Link Aggregation Control Protocol (LACP) provides a standardized means for exchanging information between Partner Systems on a link to allow their Link Aggregation Control instances to reach agreement on the identity of the Link Aggregation Group to which the link belongs, move the link to that Link Aggregation Group, and enable its transmission and reception functions in an orderly manner. Link aggregation lets you group up to 4 ports into one dedicated connection. This feature can expand bandwidth to a device on the network. **LACP operation requires full-duplex mode**, more detail information refers to IEEE 802.3ad.

Aggregator setting

- **System Priority:** A value which is used to identify the active LACP. The switch with the lowest value has the highest priority and is selected as the active LACP.
- **Group ID:** There are four trunk groups to be selected. Choose the "**Group ID**" and click .
- **LACP:** When enabled, the trunk group is using LACP. A port which joins an LACP trunk group has to make an agreement with its member ports first. When disabled, the trunk group is a static trunk group. The advantage of having the LACP disabled is that a port joins the trunk group without any handshaking with its member ports. But member ports won't know that they should be aggregated together to form a logic trunk group.
- **Work ports:** This column field allows the user to type in the total number of active port up to four. With LACP static trunk group, e.g. you assign four ports to be the members of a trunk group whose work ports column field is set as two; the exceed ports are standby (the **LACP State Activity** will show 'Passive' on the tab of **State Activity**) and can be aggregated if work ports fail. If it is a static trunk group, the number of work ports must equal the total number of group member ports.
- Select the ports to join the trunk group. The system allows four ports maximum to be aggregated in a trunk group. Click  to add the port which is focused to

the left field. To remove unwanted ports, select the port and click **Remove**.

- When LACP enabled, you can configure LACP Active/Passive status for each port on State Activity page.
- Click **Apply**.
- Use **Delete** to delete Trunk Group. Select the Group ID and click **Delete**.

Port Trunk - Aggregator Setting

Aggregator Setting		Aggregator Information	State Activity
System Priority			
<input type="text" value="1"/>			
Group ID	<input type="text" value="Trunk.1"/>	Select	
Lacp	<input type="text" value="Disable"/>		
Work Ports	<input type="text" value="2"/>		
<input type="text" value="Port.01"/> <input type="text" value="Port.02"/>	<input type="button" value=" <<Add"/> <input type="button" value=" Remove >>"/>	<input type="text" value="Port.03"/> <input type="text" value="Port.04"/> <input type="text" value="Port.05"/> <input type="text" value="Port.06"/> <input type="text" value="Port.07"/> <input type="text" value="Port.08"/>	
<input type="button" value="Apply"/> <input type="button" value="Delete"/> <input type="button" value="Help"/>			

Notice: The trunk function do not support GVRP and X-Ring.

Port Trunk—Aggregator Setting interface

Aggregator Information

When you have setup the aggregator setting with LACP disabled, you will see the local static trunk group information in here.

1. **Group Key:** Displays the trunk group ID.
2. **Port Member:** Displays the members of this static trunk group.

Port Trunk - Aggregator Information

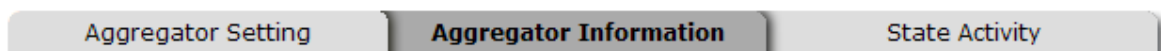

Static Trunking Group	
Group Key	1
Port Member	1 2

Port Trunk – Aggregator Information interface

State Activity

Having set up the LACP aggregator on the tab of Aggregator Setting, you can configure the state activity for the members of the LACP trunk group. You can tick or cancel the checkbox beside the state display. When you remove the tick mark to the port and click **Apply**, the port state activity will change to **Passive**.

- **Active:** The port automatically sends LACP protocol packets.
- **Passive:** The port does not automatically send LACP protocol packets, and responds only if it receives LACP protocol packets from the opposite device.

[NOTE] 1. **A link** having either two active LACP nodes or one active node can perform dynamic LACP trunk.

2. **A link** having two passive LACP nodes will not perform dynamic LACP trunk because both ports are waiting for an LACP protocol packet from the opposite device.

Port Trunk - State Activity

Aggregator Setting
Aggregator Information
State Activity

Port	LACP	State	Activity	Port	LACP	State	Activity
1			N/A	2			N/A
3			N/A	4			N/A
5			N/A	6			N/A
7			N/A	8			N/A

Apply
Help

Port Trunk – State Activity interface

Port Mirroring

The Port mirroring is a method for monitoring traffic in switched networks. Traffic through ports can be monitored by one specific port. That means traffic going in or out monitored (source) ports will be duplicated into the mirrored (destination) port.

- **Destination Port:** There is only one port that can be selected to be the destination (mirror) port for monitoring both RX and TX traffic which come from source port. Or, use one of two ports for monitoring RX traffic only and the other one for TX traffic only. User can connect mirror port to LAN analyzer or Netxray
- **Source Port:** The ports that user wants to monitor. All monitored port traffic will be copied to mirror (destination) port. User can select multiple source ports by checking the **RX** or **TX** check boxes to be monitored.
- And then, click Apply button.

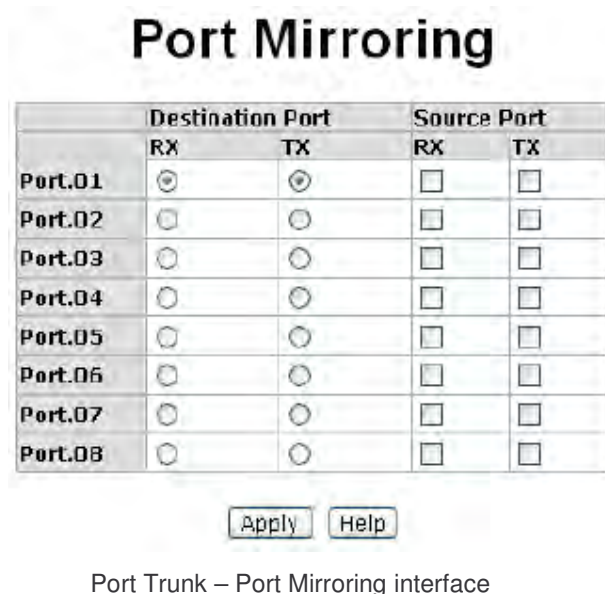

Rate Limiting

You can set up every port's bandwidth rate and frame limitation type.

- Ingress Limit Frame type:** Select the frame type that you expect to filter. The frame types have 4 options for selecting: **All**, **Broadcast/Multicast/Flooded Unicast**, **Broadcast/Multicast** and **Broadcast only**. **Broadcast/Multicast/Flooded Unicast**, **Broadcast/Multicast** and **Broadcast only** types are selectable for ingress frames. But, the egress rate only supports 'All' frame type.

Rate Limiting

	Ingress Limit Frame Type	Ingress	Egress
Port.01	Broadcast only	4096 kbps	512 kbps
Port.02	All	0 kbps	0 kbps
Port.03	All	0 kbps	0 kbps
Port.04	All	0 kbps	0 kbps
Port.05	All	0 kbps	0 kbps
Port.06	All	0 kbps	0 kbps
Port.07	All	0 kbps	0 kbps
Port.08	All	0 kbps	0 kbps

Apply Help

Rate Limiting interface

- All the ports support ingress and egress rate control which can be selected from 160kbps to 128000kbps. The switch will perform the ingress/egress rate by packet counter to meet the specified rate.
 - **Ingress:** Select the port effective ingress rate (The default value is "0")
 - **Egress:** Enter the port effective egress rate (The default value is "0")
- And then, click **Apply** to apply the settings.

VLAN configuration

A Virtual LAN (VLAN) is a logical network grouping that limits the broadcast domain. This enables isolation of network traffic, so only the members of the VLAN will receive traffic from the same VLAN members. Basically, creating a VLAN from a switch is logically equivalent to reconnecting a group of network devices to another Layer 2 switch. However, all the network devices are still plugged into the same switch physically.

The industrial switch supports port-based and 802.1Q (tagged-based) VLAN. The default configuration of VLAN operation mode is “**Disable**”.

VLAN Configuration

VLAN Operation Mode :	Disable	▼
<input type="checkbox"/>	Enable GVRP Protocol	
Management Vlan ID :	<input type="text"/>	Apply

VLAN NOT ENABLE

VLAN Configuration interface

VLAN configuration—Port-based VLAN

Packets can go among only members of the same VLAN group. Note all unselected ports are treated as belonging to another single VLAN. If port-based VLAN is enabled, the VLAN-tagging is ignored.

In order for an end station to send packets to different VLAN groups, it itself has to be either capable of tagging packets it sends with VLAN tags, or it must be attached to a VLAN-aware bridge that is capable of classifying and tagging the packet with a different VLAN ID based on not only default PVID but also other information about the packet, such as the protocol.

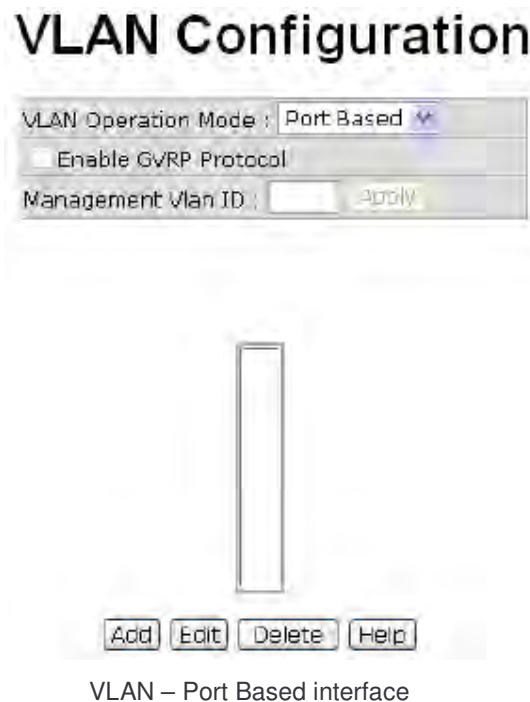

- Click **Add** to add a new VLAN group(The maximum VLAN group is up to 256 VLAN groups)
- Entering the VLAN name, group ID and grouping the members of VLAN group
- And then, click **Apply**

VLAN Configuration

VLAN Operation Mode :	Port Based ▾
<input type="checkbox"/> Enable GVRP Protocol	
Management Vlan ID :	0

Apply

Group Name		
VLAN ID	1	
Port.03 Port.04 Port.05 Port.06 Port.07 Port.08 Trunk.1	Add Remove	

Apply Help

VLAN—Port Based Add interface

- You will see the VLAN displays.
- Use **Delete** button to delete unwanted VLAN.
- Use **Edit** button to modify existing VLAN group.

Note Remember to execute the 'Save Configuration' action, otherwise the new configuration will be lost when switch power is removed.

802.1Q VLAN

Tag-based VLAN is an IEEE 802.1Q specification standard. Therefore, it is possible to create a VLAN across devices from different switch vendors. IEEE 802.1Q VLAN uses a technique to insert a “tag” into the Ethernet frames. The Tag contains a VLAN Identifier (VID) that indicates the VLAN numbers.

You can create a Tag-based VLAN, and enable or disable GVRP protocol. There are 256 VLAN groups. If 802.1Q VLAN is Enabled then all ports on the switch belong to the default VLAN, VID is 1. The default VLAN can't be deleted.

GVRP allows automatic VLAN configuration between the switch and nodes. If the switch is connected to a device with GVRP enabled, you can send a GVRP request using the VID of a VLAN defined on the switch; the switch will automatically add that device to the existing VLAN.

VLAN Configuration

VLAN Operation Mode : 802.1Q

Enable GVRP Protocol

Management Vlan ID : 0

Apply

802.1Q Configuration Group Configuration

Port	Link Type	Untagged Vid	Tagged Vid
Port.03	Access Link	1	

Apply Help

Port	Link Type	Untagged Vid	Tagged Vid
Port.03	Access Link	1	
Port.04	Access Link	1	
Port.05	Access Link	1	
Port.06	Access Link	1	
Port.07	Access Link	1	
Port.08	Access Link	1	
Trunk.1	Access Link	1	

802.1q VLAN interface

802.1Q Configuration

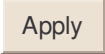
1. **Enable GVRP Protocol:** check the check box to enable GVRP protocol.
2. Select the port that you want to configure.
3. **Link Type:** There are 3 types of link type.
 - **Access Link:** Single switch only, allows user to group ports by setting the same VID to those ports.
 - **Trunk Link:** The extended application of **Access Link**. While the ports are set in this type, they can forward the packets with specified tag among the switches which are included in the same VLAN group.
 - **Hybrid Link:** Both **Access Link** and **Trunk Link** are available.
4. **Untagged VID:** assign the untagged frame VID.
5. **Tagged VID:** assign the tagged frame VID.
6. Click 
7. You can see each port setting in the below table on the screen.

Group Configuration

Edit the existing VLAN Group.

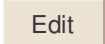
1. Select the VLAN group in the table list.
2. Click 

VLAN Configuration

VLAN Operation Mode :	802.1Q
<input type="checkbox"/> Enable GVRP Protocol	
Management Vlan ID :	0

Apply

802.1Q Configuration | **Group Configuration**

Default__1

Edit Delete

Group Configuration interface

- 3. You can Change the VLAN group name and VLAN ID.
- 4. Click **Apply** .

VLAN Configuration

VLAN Operation Mode :	802.1Q
<input type="checkbox"/> Enable GVRP Protocol	
Management Vlan ID :	0

Apply

802.1Q Configuration | **Group Configuration**

Group Name	Default
VLAN ID	1

Apply

Group Configuration interface

Rapid Spanning Tree

The Rapid Spanning Tree Protocol (RSTP) is an evolution of the Spanning Tree Protocol and provides for faster spanning tree convergence after a topology change. The system also supports STP and the system will auto detect the connected device that is running STP or RSTP protocol.

RSTP - System Configuration

- User can view spanning tree information about the Root Bridge.
- User can modify RSTP state. After modification, click button
 - **RSTP mode:** User must enable or disable RSTP function before configure the related parameters.
 - **Priority (0-61440):** A value used to identify the root bridge. The bridge with the lowest value has the highest priority and is selected as the root. The value must be a multiple of 4096 according to the protocol standard rule.
 - **Max Age (6-40):** The number of seconds a bridge waits without receiving Spanning-tree Protocol configuration messages before attempting a reconfiguration. Enter a value between 6 through 40.
 - **Hello Time (1-10):** The time that controls switch sends out the BPDU packet to check RSTP current status. Enter a value between 1 through 10.
 - **Forward Delay Time (4-30):** The number of seconds a port waits before changing from its Rapid Spanning-Tree Protocol learning and listening to STP states to the forwarding state. Enter a value between 4 through 30.

Note Follow the rule to configure the MAX Age, Hello Time, and Forward Delay Time.

$2 \times (\text{Forward Delay Time value} - 1) > = \text{Max Age value} > = 2 \times (\text{Hello Time value} + 1)$

RSTP - System Configuration

System Configuration	Port Configuration
----------------------	--------------------

RSTP Mode	Enable ▾
Priority (0-61440)	32768
Max Age (6-40)	20
Hello Time (1-10)	2
Forward Delay Time (4-30)	15

Priority must be a multiple of 4096
2*(Forward Delay Time-1) should be greater than or equal to the Max Age.
The Max Age should be greater than or equal to 2*(Hello Time + 1).

Root Bridge Information

Bridge ID	0080000F380131DD
Root Priority	32768
Root Port	Root
Root Path Cost	0
Max Age	20
Hello Time	2
Forward Delay	15

RSTP System Configuration interface

RSTP - Port Configuration

You can configure path cost and priority of every port.

1. **Path Cost:** The cost of the path to the other bridge from this transmitting bridge at the specified port. Enter a number 1 through 200000000.
2. **Priority:** Decide which port should be blocked by priority in LAN. Enter a number 0 through 240. The value of priority must be the multiple of 16.
3. **P2P:** Some of the rapid state transactions that are possible within RSTP are dependent upon whether the port concerned can only be connected to exactly one other bridge (i.e. it is served by a point-to-point LAN segment), or can be connected to two or more bridges (i.e. it is served by a shared medium LAN segment). This function allows the P2P status of the link to be manipulated administratively. True is P2P enabling. False is P2P disabling.
4. **Edge:** The port directly connected to end stations cannot create bridging loop in the network. To configure the port as an edge port, set the port to “**True**” status.
5. **Non Stp:** The port includes the STP mathematic calculation. **True** is not including STP mathematic calculation. **False** is including the STP mathematic calculation.
6. Click .

RSTP - Port Configuration

System Configuration | **Port Configuration**

Port	Path Cost (1-20000000)	Priority (0-240)	Admin P2P	Admin Edge	Admin Non Stp
Port.01 ▲					
Port.02					
Port.03	20000	128	Auto ▼	true ▼	false ▼
Port.04					
Port.05 ▼					

priority must be a multiple of 16

Apply Help

RSTP Port Status

Port	Path Cost	Port Priority	Oper P2P	Oper Edge	Stp Neighbor	State	Role
Port.01	20000	128	True	True	False	Disabled	Disabled
Port.02	20000	128	True	True	False	Disabled	Disabled
Port.03	20000	128	True	True	False	Disabled	Disabled
Port.04	20000	128	True	True	False	Disabled	Disabled
Port.05	20000	128	True	True	False	Forwarding	Designated
Port.06	20000	128	True	True	False	Disabled	Disabled
Port.07	20000	128	True	True	False	Disabled	Disabled
Port.08	20000	128	True	True	False	Disabled	Disabled

RSTP Port Configuration interface

SNMP Configuration

Simple Network Management Protocol (SNMP) is the protocol developed to manage nodes (servers, workstations, routers, switches and hubs etc.) on an IP network. SNMP enables network administrators to manage network performance, find and solve network problems, and plan for network growth. Network management systems learn of problems by receiving traps or change notices from network devices implementing SNMP.

System Configuration

■ Community Strings

You can define a new community string set or remove unwanted community string.

1. **String:** Fill the name of string.
2. **RO:** Read only. Enables requests accompanied by this string to display MIB-object information.
3. **RW:** Read write. Enables requests accompanied by this string to display MIB-object information and to set MIB objects.

1. Click **Add**.
2. To remove the community string, select the community string that you have defined and click **Remove**. You cannot edit the name of the default community string set.

- **Agent Mode:** Select the SNMP version that you want to use it. And then click **Change** to switch to the selected SNMP version mode.

SNMP - System Configuration

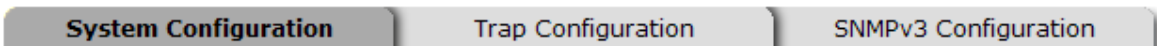

Community Strings

Current Strings : <input type="button" value="Remove"/>	New Community String : <input type="button" value="Add"/>
public__RO private__RW	String : <input type="text"/> <input type="radio"/> RO <input type="radio"/> RW

Agent Mode

Current Mode: SNMP v1/v2c only	<input type="radio"/> SNMP V1/V2C only <input type="radio"/> SNMP V3 only <input type="radio"/> SNMP V1/V2C/V3
<input type="button" value="Change"/>	

SNMP System Configuration interface

Trap Configuration

A trap manager is a management station that receives traps, the system alerts generated by the switch. If no trap manager is defined, no traps will issue. Create a trap manager by entering the IP address of the station and a community string. To define management stations as trap manager and enter SNMP community strings and selects the SNMP version.

1. **IP Address:** Enter the IP address of trap manager.
2. **Community:** Enter the community string.
3. **Trap Version:** Select the SNMP trap version type—v1 or v2c.
4. Click **Add**.
5. To remove the community string, select the community string that you have defined and click **Remove**. You cannot edit the name of the default community string set.

SNMP - Trap Configuration

System Configuration	Trap Configuration	SNMPv3 Configuration
Trap Managers		
Current Managers :		New Manager :
Remove		Add
(none)		IP Address : <input type="text"/>
		Community : <input type="text"/>
		Trap version: <input checked="" type="radio"/> v1 <input type="radio"/> v2c
Help		

Trap Managers interface

SNMPV3 Configuration

Configure the SNMP V3 function.

Context Table

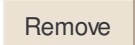
Configure SNMP v3 context table. Assign the context name of context table. Click  to add context name. Click  to remove unwanted context name.

User Profile

Configure SNMP v3 user table..

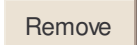
- **User ID:** Set up the user name.
- **Authentication Password:** Set up the authentication password.
- **Privacy Password:** Set up the private password.
- Click  to add context name.
- Click  to remove unwanted context name.

SNMP - SNMPv3 Configuration

System Configuration		Trap Configuration		SNMPv3 Configuration	
Context Table					
Context Name :				<input type="text"/>	
				<input type="button" value="Apply"/>	
User Table					
Current User Profiles :		New User Profile :			
<input type="button" value="Remove"/>		<input type="button" value="Add"/>			
<input type="text" value="(none)"/>		User ID: <input type="text"/>			
		Authentication Password: <input type="text"/>			
		Privacy Password: <input type="text"/>			
Group Table					
Current Group content :		New Group Table:			
<input type="button" value="Remove"/>		<input type="button" value="Add"/>			
<input type="text" value="(none)"/>		Security Name (User ID): <input type="text"/>			
		Group Name: <input type="text"/>			
Access Table					
Current Access Tables :		New Access Table :			
<input type="button" value="Remove"/>		<input type="button" value="Add"/>			
<input type="text" value="(none)"/>		Context Prefix: <input type="text"/>			
		Group Name: <input type="text"/>			
		Security Level: <input type="radio"/> NoAuthNoPriv. <input type="radio"/> AuthNoPriv. <input type="radio"/> AuthPriv.			
		Context Match Rule <input type="radio"/> Exact <input type="radio"/> Prefix			
		Read View Name: <input type="text"/>			
		Write View Name: <input type="text"/>			
Notify View Name: <input type="text"/>					
MIBView Table					
Current MIBTables :		New MIBView Table :			
<input type="button" value="Remove"/>		<input type="button" value="Add"/>			
<input type="text" value="(none)"/>		View Name: <input type="text"/>			
		SubOid-Tree: <input type="text"/>			
		Type: <input type="radio"/> Excluded <input type="radio"/> Included			
<input type="button" value="Help"/>					

Note:
 Any modification of SNMPv3 tables might cause MIB accessing rejection. Please take notice of the causality between the tables before you modify these tables.

SNMP V3 configuration interface

Group Table

Configure SNMP v3 group table.

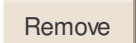
- **Security Name (User ID):** Assign the user name that you have set up in user table.
- **Group Name:** Set up the group name.
- Click  to add context name.
- Click  to remove unwanted context name.

Access Table

Configure SNMP v3 access table.

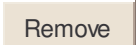
- **Context Prefix:** Set up the context name.
- **Group Name:** Set up the group.
- **Security Level:** Select the access level.
- **Context Match Rule:** Select the context match rule.
- **Read View Name:** Set up the read view.
- **Write View Name:** Set up the write view.
- **Notify View Name:** Set up the notify view.
- Click  to add context name.
- Click  to remove unwanted context name.

MIBview Table

Configure MIB view table.

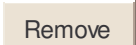
- **ViewName:** Set up the name.
- **Sub-Oid Tree:** Fill the Sub-OID.
- **Type:** Select the type – exclude or included.
- Click  to add context name.
- Click  to remove unwanted context name.

QoS Configuration

You can configure QoS policy and priority setting, per port priority setting, COS and TOS setting.

QoS Policy and Priority Type

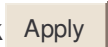
- **QoS Policy:** select the QoS policy rule.
 - **Using the 8,4,2,1 weight fair queue scheme:** The switch will follow 8:4:2:1 rate to process priority queue from High to lowest queue. For example, when the system processes, 1 frame of the lowest queue, 2 frames of the low queue, 4 frames of the middle queue, and 8 frames of the high queue will be processed at the same time in accordance with the 8,4,2,1 policy rule.
 - **Use the strict priority scheme:** Always higher queue will be process first, except higher queue is empty.
- **Priority Type:** there are 5 priority type selections available. Disable means no priority type is selected.
- **Port-base:** the port priority will follow the **Port-base** that you have assigned – High, middle, low, or lowest.
 - **COS only:** the port priority will only follow the **COS priority** that you have assigned.
 - **TOS only:** the port priority will only follow the **TOS priority** that you have assigned.
 - **COS first:** the port priority will follow the COS priority first, and then other priority rule.
 - **TOS first:** the port priority will follow the TOS priority first, and the other priority rule.
- Click  .

QoS Configuration

Qos Policy:

Use an 8,4,2,1 weighted fair queuing scheme
 Use a strict priority scheme
Priority Type: Disable

Apply Help

Port-based Priority:

Port.01	Port.02	Port.03	Port.04	Port.05	Port.06	Port.07	Port.08
Lowest	Lowest	Lowest	Lowest	Lowest	Lowest	Lowest	Lowest

Apply Help

COS:

Priority	0	1	2	3	4	5	6	7
	Lowest	Lowest	Lowest	Lowest	Lowest	Lowest	Lowest	Lowest

Apply Help

TOS:

Priority	0	1	2	3	4	5	6	7
	Lowest	Lowest	Lowest	Lowest	Lowest	Lowest	Lowest	Lowest
Priority	8	9	10	11	12	13	14	15
	Lowest	Lowest	Lowest	Lowest	Lowest	Lowest	Lowest	Lowest
Priority	16	17	18	19	20	21	22	23
	Lowest	Lowest	Lowest	Lowest	Lowest	Lowest	Lowest	Lowest
Priority	24	25	26	27	28	29	30	31
	Lowest	Lowest	Lowest	Lowest	Lowest	Lowest	Lowest	Lowest
Priority	32	33	34	35	36	37	38	39
	Lowest	Lowest	Lowest	Lowest	Lowest	Lowest	Lowest	Lowest
Priority	40	41	42	43	44	45	46	47
	Lowest	Lowest	Lowest	Lowest	Lowest	Lowest	Lowest	Lowest
Priority	48	49	50	51	52	53	54	55
	Lowest	Lowest	Lowest	Lowest	Lowest	Lowest	Lowest	Lowest
Priority	56	57	58	59	60	61	62	63
	Lowest	Lowest	Lowest	Lowest	Lowest	Lowest	Lowest	Lowest

Apply Help

QoS Configuration interface

Port Base Priority

Configure per port priority level.

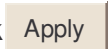
- **Port:** Each port has 4 egress queues – High, Middle, Low, and Lowest.
- Click .

COS Configuration

Set up the COS priority level.

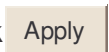
- **COS priority:** Set up the COS priority level 0~7 with 4 egress queues: High, Middle, Low, Lowest.
- Click .

TOS Configuration

Set up the TOS priority.

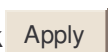
- **TOS priority:** the system provides 0~63 TOS priority level. Each level has 4 types of priority (egress queues) – high, middle, low, and lowest. The default value is “Lowest” priority for each level. When the IP packet is received, the system will check the TOS level value in the IP packet that has received. For example, user set the TOS level 25 as high, the system will check the TOS value of the received IP packet. If the TOS value of received IP packet is 25(priority = high), and then the packet priority will have highest priority.
- Click .

IGMP Configuration

The Internet Group Management Protocol (IGMP) is an internal protocol of the Internet Protocol (IP) suite. IP manages multicast traffic by using switches, routers, and hosts that support IGMP. Enabling IGMP allows the ports to detect IGMP queries and report packets and manage IP multicast traffic through the switch. IGMP has three fundamental types of message as follows:

Message	Description
Query	A message sent from the querier (IGMP router or switch) asking for a response from each host belonging to the multicast group.
Report	A message sent by a host to the querier to indicate that the host wants to be or is a member of a given group indicated in the report message.
Leave Group	A message sent by a host to the querier to indicate that the host has quit being a member of a specific multicast group.

The switch supports IP multicast. You can enable IGMP protocol via setting IGMP configuration page to see the IGMP snooping information. IP multicast addresses are in the range of 224.0.0.0 through 239.255.255.255.

- **IGMP Protocol:** Enable or disable the IGMP protocol.
- **IGMP Query:** Select the IGMP query function as Enable or Auto to set the switch as a querier for IGMP version 2 multicast network.
- Click .

IGMP Configuration

IP Address	VLAN ID	Member Port
239.255.255.250	1	****5****

IGMP Snooping:

IGMP Query:

IGMP Configuration interface

X-Ring

X-Ring provides a faster redundant recovery than Spanning Tree topology. The action is similar to STP or RSTP, but the algorithms are different.

In the X-Ring topology, every switch should enable X-Ring function and assign two member ports for connecting to the ring. Only one switch in the X-Ring group would be set as the master switch with one of the member ports blocked, called backup port, and another port is called working port. Other switches in the X-Ring group are called working switches and their two member ports are called working ports. When a failure of a network connection occurs, the backup port will automatically become a working port to recover from the failure.

The switch supports the function and interface for setting the switch as the ring master or slave mode. The ring master can negotiate and command other switches in the X-Ring group. If there are 2 or more switches in master mode, then software will select the switch with lowest MAC address number as the ring master. The X-Ring master ring mode will be enabled by the X-Ring configuration interface. Also, users can identify the switch as the ring master when the R.M. LED on the switch is lit.

The system also supports the coupling ring that can connect 2 or more X-Ring group for the redundant backup function and dual homing function that prevents lost connection between an X-Ring group and an upper level/core switch.

- **Enable X-Ring:** To enable the X-Ring function. Marking the check box to enable the X-Ring function.
- **Enable Ring Master:** Mark the check box for enabling this machine to be a ring master.
- **1st & 2nd Ring Ports:** Pull down the selection menu to assign two ports as the member ports. The **1st Ring Port** and **2nd Ring Port** are basically assigned to be forwarding ports except for the Ring Master switch. With the Ring Master switch, one of its two Ring Ports is the blocking port and another one is the forwarding port. Once its forwarding port fails, the system will automatically upgrade its blocking port

to be the forwarding port of the Ring Master switch.

- **Enable Coupling Ring:** To enable the coupling ring function. Marking the check box to enable the coupling ring function.
- **Coupling port:** Assign the member port which is connected to the other ring group.
- **Control port:** When Couple Ring check box is marked, you have to assign the control port to form a couple-ring group between the two X-rings.
- **Enable Dual Homing:** Set up one of the ports on the switch to be the Dual Homing port. For a switch, there is only one Dual Homing port. Dual Homing only works while the X-Ring function enabled.
- And then, click to apply the configuration.

X-Ring Configuration

<input checked="" type="checkbox"/> Enable Ring	
<input checked="" type="checkbox"/> Enable Ring Master	
1st Ring Port	Port.01 ▾
2nd Ring Port	Port.02 ▾
<input type="checkbox"/> Enable Couple Ring	
Coupling Port	Port.03 ▾
Control Port	Port.04 ▾
<input type="checkbox"/> Enable Dual Homing	Port.05 ▾

1st Ring Port	2nd Ring Port	Coupling Port	Control Port	Homing Port
FORWARDING	FORWARDING	FORWARDING	FORWARDING	FORWARDING

This switch is Ring Master.

X-ring Interface

Note When the X-Ring function enable, user must disable the RSTP. The X-Ring function and RSTP function cannot exist in a switch at the same time. Remember to execute the ‘Save Configuration’ action, otherwise the new configuration will be lost when switch power is removed.

LLDP Configuration

Link Layer Discovery Protocol (LLDP) is defined in the IEEE 802.1AB. It is an emerging standard which provides a solution for the configuration issues caused by expanding LANs. LLDP specifically defines a standard method for Ethernet network devices such as switches, routers and wireless LAN access points to advertise information about themselves to other nodes on the network and store the information they discover. LLDP runs on all 802 media. The protocol runs over the data-link layer only, allowing two systems running different network layer protocols to learn about each other.

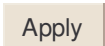
- **LLDP Protocol:** Pull down the selection menu to disable or enable LLDP function.
- **LLDP Interval:** Set the interval of advertising the switch's information to other nodes.
- Click  .

LLDP Configuration

LLDP Protocol:

LLDP Interval: sec

LLDP Interface

Security

In this section, you can configure 802.1x and MAC address table.

802.1X/RADIUS Configuration

802.1x is an IEEE authentication specification that prevents the client from accessing the wireless access point or wired switch until it provides authority, like the user name/password that are verified by an authentication server.

System Configuration

After enabling the IEEE 802.1X function, you can configure the parameters of this function.

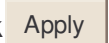
1. **IEEE 802.1x Protocol:** Enable or disable 802.1x protocol.
2. **Radius Server IP:** Set the Radius Server IP address.
3. **Server Port:** Set the UDP destination port for authentication requests to the specified Radius Server.
4. **Accounting Port:** Set the UDP destination port for accounting requests to the specified Radius Server.
5. **Shared Key:** Set an encryption key for using during authentication sessions with the specified radius server. This key must match the encryption key used on the Radius Server.
6. **NAS, Identifier:** Set the identifier for the radius client.
7. Click .

802.1x/RADIUS - System Configuration

System Configuration | Port Configuration | Misc Configuration

802.1x Protocol	Disable ▾
Radius Server IP	0.0.0.0
Server Port	1812
Accounting Port	1813
Shared Key	12345678
NAS, Identifier	NAS_L2_SWITCH

Apply | Help

802.1x System Configuration interface

802.1x Port Configuration

You can configure 802.1x authentication state for each port. The State provides Disable, Accept, Reject and Authorize.

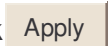
- **Reject:** The specified port is required to be held in the unauthorized state.
- **Accept:** The specified port is required to be held in the Authorized state.
- **Authorized:** The specified port is set to the Authorized or Unauthorized state in accordance with the outcome of an authentication exchange between the Supplicant and the authentication server.
- **Disable:** When disabled, the specified port works without complying with 802.1x protocol.
- Click  .

802.1x/Radius - Port Configuration

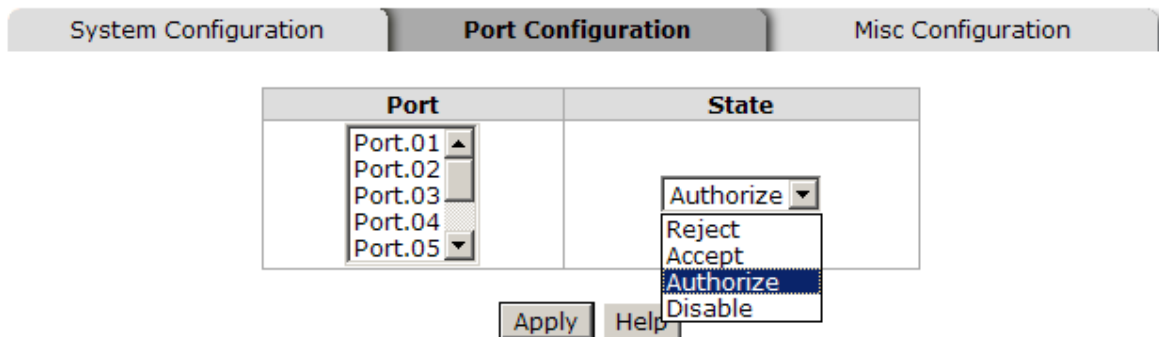

Port Authorization

Port	State
Port.01	Disable
Port.02	Disable
Port.03	Disable
Port.04	Disable
Port.05	Disable
Port.06	Disable
Port.07	Disable
Port.08	Disable

802.1x Per Port Setting interface

Misc Configuration

1. **Quiet Period:** Set the period during which the port doesn't try to acquire a supplicant.
2. **TX Period:** Set the period the port wait for retransmit next EAPOL PDU during an authentication session.
3. **Supplicant Timeout:** Set the period of time the switch waits for a supplicant response to an EAP request.
4. **Server Timeout:** Set the period of time the switch waits for a server response to an authentication request.
5. **Max Requests:** Set the number of authentication that must time-out before authentication fails and the authentication session ends.
6. **Reauth period:** Set the period of time after which clients connected must be re-authenticated.
7. Click .

802.1x/Radius - Misc Configuration

System Configuration	Port Configuration	Misc Configuration
Quiet Period	<input type="text" value="60"/>	
Tx Period	<input type="text" value="30"/>	
Supplicant Timeout	<input type="text" value="30"/>	
Server Timeout	<input type="text" value="30"/>	
Max Requests	<input type="text" value="2"/>	
Reauth Period	<input type="text" value="3600"/>	
<input type="button" value="Apply"/> <input type="button" value="Help"/>		

802.1x Misc Configuration interface

MAC Address Table

Use the MAC address table to ensure port security.

Static MAC Address

You can add a static MAC address; it remains in the switch's address table, regardless of whether the device is physically connected to the switch. This saves the switch from having to re-learn a device's MAC address when the disconnected or powered-off device is active on the network again. You can add / modify / delete a static MAC address.

Add the Static MAC Address

You can add static MAC address in the switch MAC table here.

- **MAC Address:** Enter the MAC address of the port that should permanently forward traffic, regardless of the device network activity.
- **Port No.:** Pull down the selection menu to select the port number.
- Click .
- If you want to delete the MAC address from filtering table, select the MAC address and click .

MAC Address Table - Static MAC Addresses

Static MAC Addresses
MAC Filtering
All Mac Addresses
Multicast Filtering

AABBCCDDEEFF	Port.01
FFEEDDCCBBAA	Port.01

MAC Address

Port No.

Port.01 ▾

Static MAC Addresses interface

MAC Filtering

By filtering MAC addresses, the switch can easily filter the pre-configured MAC address and reduce insecurity. You can add and delete filtering MAC address.

MAC Address Table - MAC Filtering

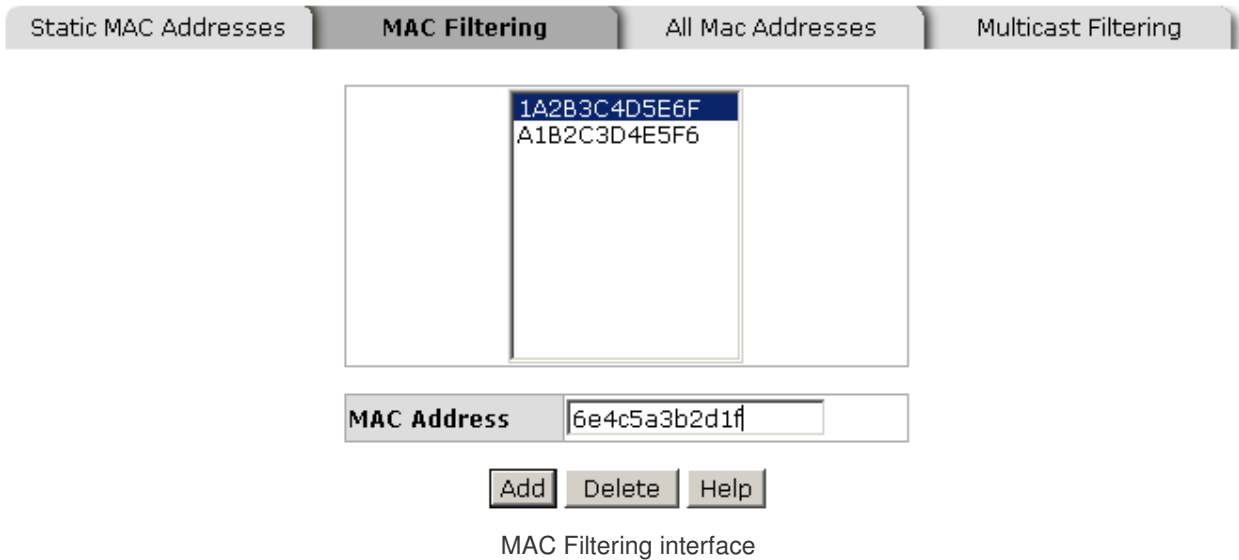

- **MAC Address:** Enter the MAC address that you want to filter.
- Click **Add**.
- If you want to delete the MAC address from the filtering table, select the MAC address and click **Delete**.

All MAC Addresses

You can view all of the MAC addresses learned by the selected port.

- Select the port number.
- The selected port of static & dynamic MAC address information will be displayed in here.
- Click to clear the dynamic MAC addresses information of the current port shown on the screen.

MAC Address Table - All Mac Addresses

Static MAC Addresses MAC Filtering **All Mac Addresses** Multicast Filtering

Port No:

112244335566	_____	STATIC
334455662211	_____	STATIC
FFE3D2CC213F	_____	STATIC

Dynamic Address Count:0
Static Address Count:3

All MAC Address interface

MAC Address Table—Multicast Filtering

Multicasts are similar to broadcasts. They are sent to all end stations on a LAN or VLAN. Multicast filtering determines which end stations can receive the multicast traffic if the connected ports had been included in the specific multicast groups. With multicast filtering, network devices only forward multicast traffic to the ports that are connected to the registered end stations.

- **IP Address:** Assign a multicast group IP address in the range of 224.0.0.0 ~ 239.255.255.255.
- **Member Ports:** Tick the check box beside the port number to include them as the member ports in the specific multicast group IP address.
- Click **Add** to append a new filter of multicast to the field, or select the filter in the field and click **Delete** to remove it.

MAC Address Table - Multicast Filtering

Static MAC Addresses
MAC Filtering
All Mac Addresses
Multicast Filtering

```

240.000.000.100___12*****
240.000.001.100___**34****
240.000.002.100___****56**
    
```

IP Address	<input type="text" value="240.0.3.100"/>
Member Ports	<input type="checkbox"/> Port.01 <input type="checkbox"/> Port.02 <input type="checkbox"/> Port.03 <input type="checkbox"/> Port.04
	<input type="checkbox"/> Port.05 <input type="checkbox"/> Port.06 <input checked="" type="checkbox"/> Port.07 <input checked="" type="checkbox"/> Port.08

Add
Delete
Help



Multicast Filtering interface

Factory Default

Reset switch to default configuration. Click  to reset all configurations to the default value.

Factory Default

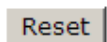
- Keep current IP address setting?
- Keep current username & password?



 

Factory Default interface

Save Configuration

Save all configurations that you have made in the system. Click  to save the all configuration to the flash memory.

Save Configuration

Save Configuration interface

System Reboot

Reboot the switch in software reset. Click  to reboot the system.

System Reboot

Please click [**Reboot**] button to restart switch device.

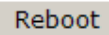

System Reboot interface

Troubleshooting

- Verify the switch is using the right power cord/adapter (DC 12-48V), please don't use the power adapter with DC voltage higher than 48V, or it may damage the switch.
- Select the proper UTP cable to construct user network. Please check that is using the right cable. Use unshielded twisted-pair (UTP) or shield twisted-pair (STP) cable for RJ-45 connections: 100 Ω Category 3, 4 or 5 cable for 10Mbps connections, 100 Ω Category 5 cable for 100Mbps connections, or 100 Ω Category 5e/6 cable for 1000Mbps connections. Also be sure that the length of any twisted-pair connection does not exceed 100 meters (328 feet).
- **Diagnosing LED Indicators:** The Switch can be easily monitored through panel indicators, which indicate common problems. Check the switch panel LEDs to assist in identifying problems.
- If the power indicator does not light on when the power cord is plugged in, there may be a problem with the power cord. Check for loose power connections, power losses or surges at power outlet. If user still cannot resolve the problem, contact user local dealer for assistance.
- If the Industrial switch LED indicators are normal and the connected cables are correct but the packets still cannot transmit, Please check configuration or status.

Technical Specification

The 6 10/100/1000T + 2 10/100/1000T/ 100/1000 SFP Combo w/ X-Ring Managed Switch technical specification is following.

Standard	IEEE 802.3 10Base-T Ethernet IEEE 802.3u 100Base-TX IEEE802.3ab 1000Base-T IEEE802.3z Gigabit fiber IEEE802.3x Flow Control and Back Pressure IEEE802.3ad Port trunk with LACP IEEE802.1d Spanning Tree IEEE802.1w Rapid Spanning Tree IEEE802.1p Class of Service IEEE802.1Q VLAN Tag IEEE 802.1x User Authentication (Radius) IEEE802.1ab LLDP
SNMP MIB	RFC 1215 Trap, RFC 1213 MIBII, RFC 1157 SNMP MIB, RFC 1493 Bridge MIB, RFC 2674 VLAN MIB, RFC 1643, RFC 1757, RSTP MIB, Private MIB, LLDP MIB
Back-Plane (Switching Fabric)	16 Gbps
Packet throughput ability	23.8Mpps at 64bytes
Technology	Store and forward switching architecture
Transfer Rate	14,880 pps for 10Base-T Ethernet port 148,800 pps for 100Base-TX/FX Fast Ethernet port 1,488,000 pps for Gigabit Ethernet port

Packet Buffer	1Mbits
MAC address	8K MAC address table
Flash ROM	4Mbytes
DRAM	32Mbytes
Connector	10/100/1000TX: 6 ports RJ-45 with Auto MDI/MDI-X function 10/100/1000T/Mini-GBIC Combo: 2 x RJ-45 + 2 x 100/1000 SFP sockets RS-232 interface: RJ-45 type
Network Cable	10/100/1000Base-T: 2-pair UTP/STP Cat. 5e/6 cable EIA/TIA-568 100-ohm (100m) SFP (Mini-GBIC): Multi-mode: 50/125 μ m~62.5/125 μ m Single-mode: 9/125 μ m
Protocol	CSMA/CD
LED	Per port: Link/Activity (Green), Speed 1000M (Green) SFP (Mini-GBIC): Link/Activity (Green) Per unit: Power (Green), Power 1 (Green), Power 2 (Green), Fault (Red), Master (Green)
Power Supply	Input Power Isolation design for Telecom application 12 ~48 VDC Redundant power and removable terminal block
Power Consumption	18 Watts

Install	DIN rail kit for DIN-type cabinet and wall mount ear for wall mount install
Operation Temp.	-10°C to 60°C (14°F to 140°F)
Operation Humidity	5% to 95% (Non-condensing)
Storage Temperature	-40°C to 85°C
Case Dimension	IP-30, 72 mm (W) x 105 mm (D) x 152mm (H)
EMI	FCC Class A CE EN61000-4-2 (ESD) CE EN61000-4-3 (RS) CE EN61000-4-4 (EFT) CE EN61000-4-5 (Surge) CE EN61000-4-6 (CS) CE EN61000-4-8 CE EN61000-4-11 CE EN61000-4-12 CE EN61000-6-2 CE-EN61000-6-4
Safety	UL, cUL, CE/EN60950-1
Stability testing	IEC60068-2-32 (Free fall) IEC60068-2-27 (Shock) IEC60068-2-6 (Vibration)
X-Ring	Supports X-Ring, Dual Homing, and Couple Ring Provides redundant backup feature and recovery time from failure less than 300ms
VLAN	Port based VLAN IEEE802.1Q Tag VLAN (256 entries)/VLAN ID (up to 4 K, VLAN ID can be assigned from 1 to 4096)

	<p>GVRP (256 Groups)</p> <p>Double Tag VLAN (Q in Q)*</p> <p>Private VLAN**</p>
Port Trunk with LACP	LACP Port Trunk: 4 Trunk groups/Maximum 4 trunk members
Class of service	<p>IEEE802.1p class of service</p> <p>Per port provides 4 priority queues.</p>
Quality of service	The QoS determined by port, Port based/Tag based, IPv4/IPv6 Different Service
Spanning tree	<p>IEEE802.1d spanning tree</p> <p>IEEE802.1w rapid spanning tree.</p>
Port mirror	TX packet only, RX packet only, Both of TX and RX packet
IGMP	<p>IGMP snooping v1, v2</p> <p>Up to 256 multicast groups and IGMP query</p>
Bandwidth control	<ul style="list-style-type: none"> ■ Ingress packets filter and egress packet limit. ■ The egress rate control supports all of packet type and the limit rate is in the range of 100 kbps to 102400 kbps or to 256000 kbps for giga ports, and zero means no limit. ■ Ingress filter packet type combination rule for Broadcast/Multicast/Flooded Unicast packet, Broadcast/Multicast packet, Broadcast packet only and all of packet. ■ The ingress packet filter rate range is from 100 kbps to 102400 kbps or to 256000 kbps for giga ports, and zero means no limit.
IP security	Supports 10 IP addresses that have permission to access the switch management and to prevent unauthorized intruder
Login Security	Supports IEEE802.1X Authentication/RADIUS

SNTP	Supports Simple Network Time Protocol to synchronize system clock in Internet.
SNMP Trap	Up to 3 Trap stations Cold start Port link Up Port link down Authentication Failure Private Trap for power status Port Alarm configuration Fault alarm X-Ring topology change
Relay Alarm	One relay output for port breakdown and power fail Alarm Relay current carry ability: 1A @ DC24V
DHCP client	Provide DHCP Client/ DHCP Server/IP Relay functions
Firmware update	TFTP firmware update
Configuration upload/download	Supports binary configuration file for system quick installation

* Future release

** Optional

Appendix

10 /100BASE-TX Pin outs

With 10/100BASE-TX cable, pins 1 and 2 are used for transmitting data, and pins 3 and 6 for receiving data.

■ RJ-45 Pin Assignments

Pin Number	Assignment
1	Tx+
2	Tx-
3	Rx+
6	Rx-

[NOTE] “+” and “-” signs represent the polarity of the wires that make up each wire pair.

The table below shows the 10 / 100BASE-TX MDI and MDI-X port pin outs.

Pin MDI-X	Signal Name	MDI Signal Name
1	Receive Data plus (RD+)	Transmit Data plus (TD+)
2	Receive Data minus (RD-)	Transmit Data minus (TD-)
3	Transmit Data plus (TD+)	Receive Data plus (RD+)
6	Transmit Data minus (TD-)	Receive Data minus (RD-)

10/100Base-TX Cable Schematic

The following two figures show the 10/100Base-TX cable schematic.

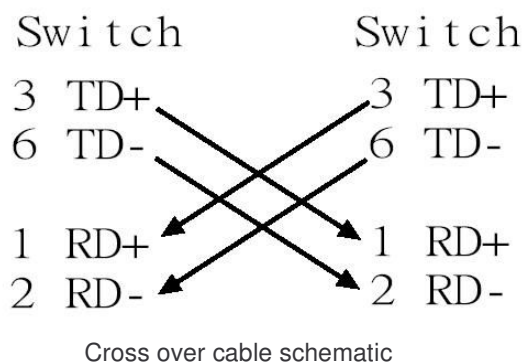
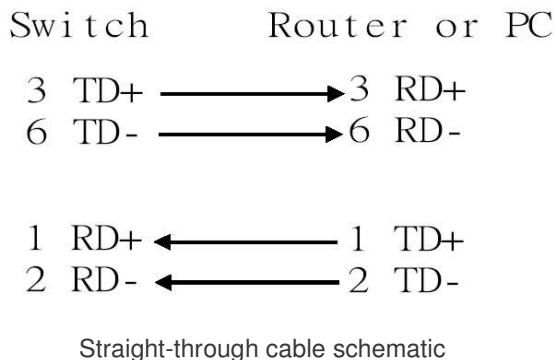

10/100/1000Base-TX Pin outs

The following figure shows the 10/100/1000 Ethernet RJ-45 pin outs.

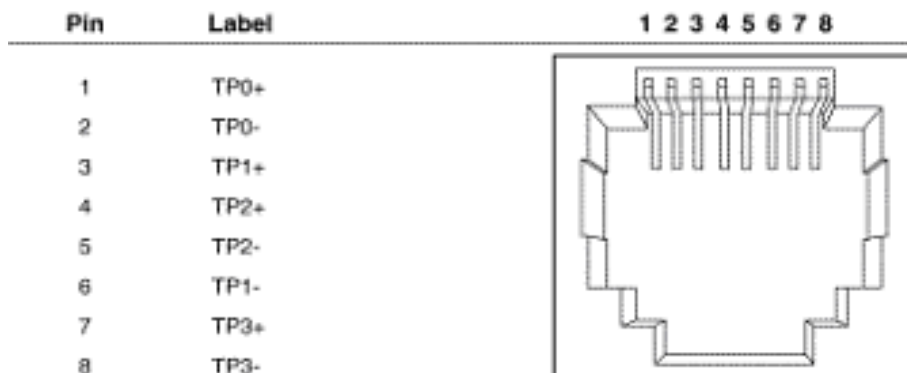

10/100/1000Base-TX Cable Schematic

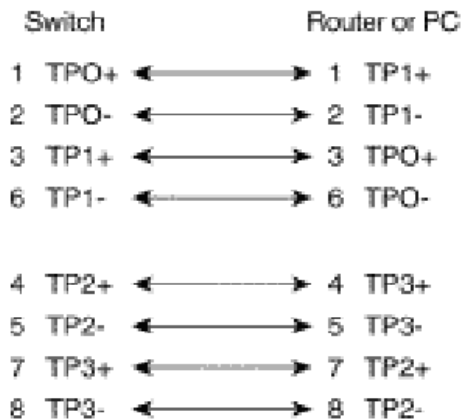

Straight through cables schematic

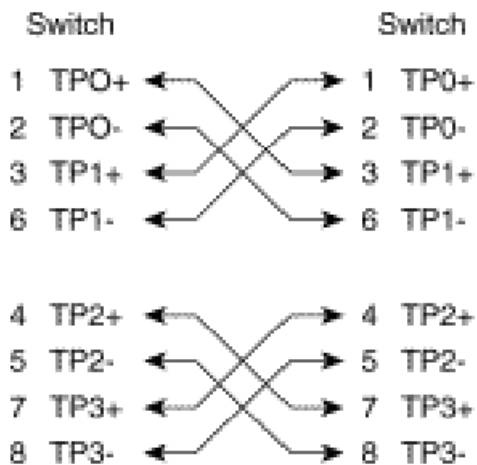

Cross over cables schematic

Gigabit Copper/SFP (mini-GBIC) combo port

The Industrial switch has two auto-detect Giga port—UTP/Fiber combo ports. The Gigabit Copper (10/100/1000T) ports should use Category 5e or above UTP/STP cable for connection. The SFP slots are for connecting to the network segment with single or multi-mode fiber. You can choose an appropriate mini-GBIC module to plug into the slots.

Make sure the module is aligned correctly and then slide the module into the SFP slot until a click is heard. You should use proper multi-mode or single-mode fiber according to the used SFP module. Fiber optic connections enable transmit speeds up to 1000 Mbps, while preventing electrical noise interference and permitting transmission distance up to 110 km, depending on the mini-GBIC module.

The small form-factor pluggable (SFP) is a compact optical transceiver used in optical communications for both telecommunication and data communications applications.

To connect the transceiver and LC cable, please follow the steps shown below:

First, insert the transceiver into the SFP slot. Notice that the triangle mark is the bottom of the slot.

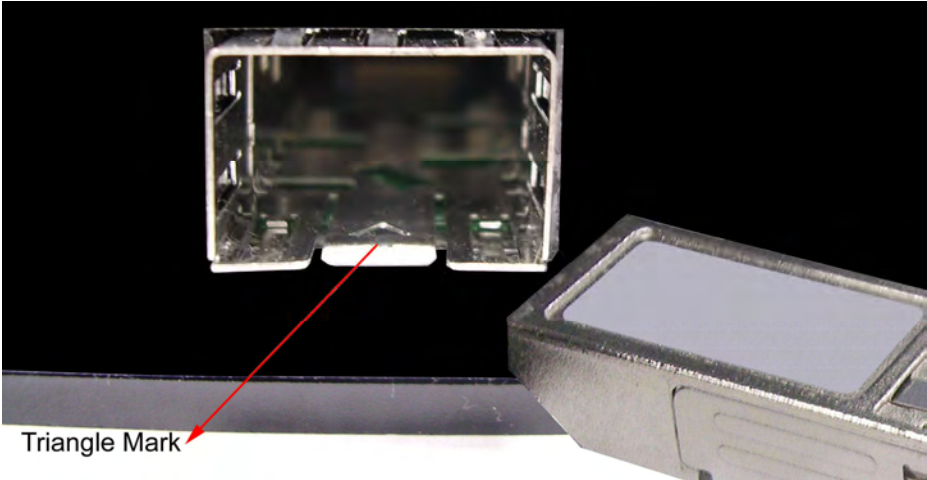

Figure 2.8: Transceiver to the SFP slot

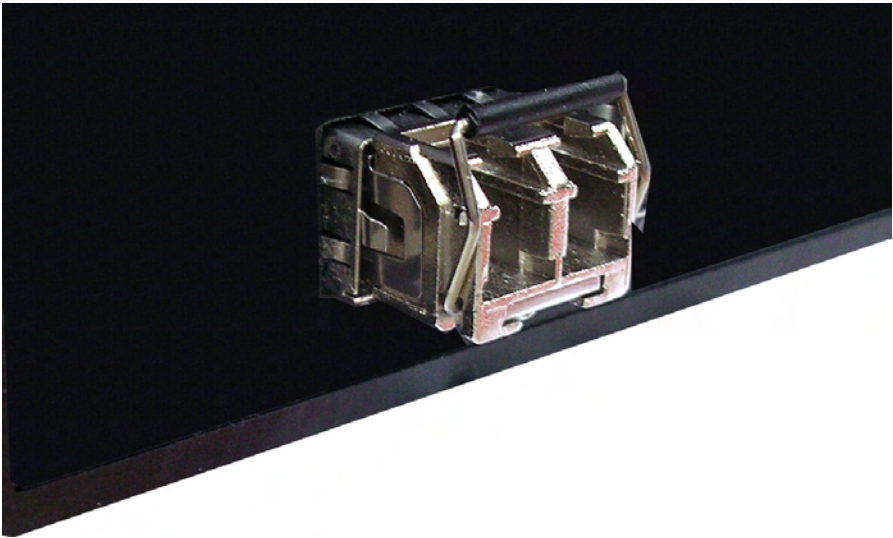

Figure 2.9: Transceiver Inserted

Second, insert the fiber cable of LC connector into the transceiver.

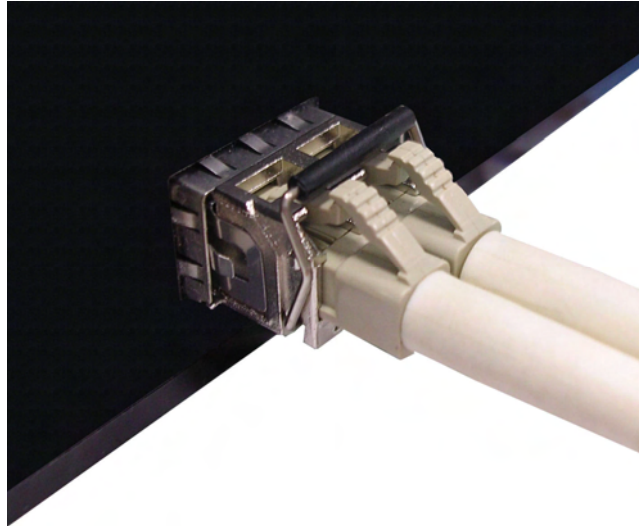

Figure 2.10: LC connector to the transceiver

To remove the LC connector from the transceiver, please follow the steps shown below:

First, press the upper side of the LC connector to release from the transceiver and pull it out.

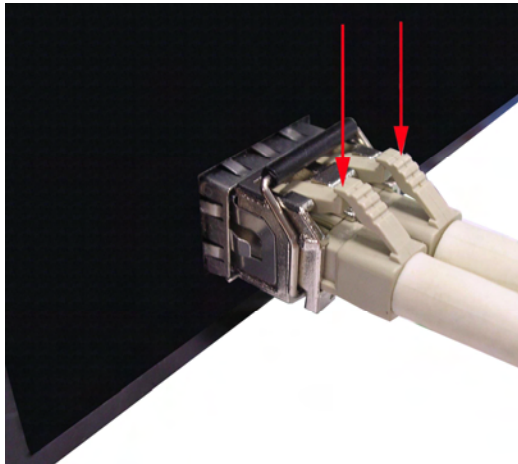

Figure 2.11: Remove LC connector

Second, push down the metal loop and pull the transceiver out by the plastic handle.

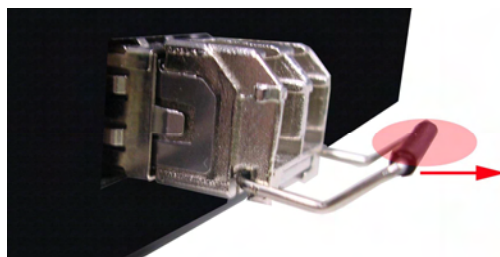

Figure 2.12: Pull out from the transceiver

Cabling

- Use four twisted-pair, Category 5e/above cabling for RJ-45 port connection. The cable between the switch and the link partner (switch, hub, workstation, etc.) must be less than 100 meters (328 ft.) long.
- Fiber segment using **single-mode** connector type must use 9/125 μm single-mode fiber cable.
- Fiber segment using **multi-mode** connector type must use 50 or 62.5/125 μm multi-mode fiber cable.