

Drying Tumblers

Stacked 30 Pound Capacity
Stacked 45 Pound Capacity
Starting Serial No. 0602004144
Refer to Page 3 for Model Numbers

— Operation/Programming/Maintenance —

Keep These Instructions for Future Reference.

(If this machine changes ownership, this manual must accompany machine.)



www.comlaundry.com

Part No. 70400101R2
July 2007

Installation must conform with local codes or in the absence of local codes with:

In the U.S.A., installation must conform to the latest edition of the American National Standard Z223.1/ NFPA 54 “National Fuel Gas Code” and Standard ANSI/NFPA 70 “National Electric Code.”

In Canada, installation must comply with Standards CSA-B149.1 or Natural Gas and Propane Code CSA C22.1, latest edition, Canadian Electric Code, Part I.

In Australia, installation must comply with the Australian Gas Association Installation Code for Gas Burning Appliances and Equipment.

	WARNING
<p>FOR YOUR SAFETY, the information in this manual must be followed to minimize the risk of fire or explosion or to prevent property damage, personal injury or death. W033</p> <ul style="list-style-type: none">• Do not store or use gasoline or other flammable vapors and liquids in the vicinity of this or any other appliance.• WHAT TO DO IF YOU SMELL GAS:<ul style="list-style-type: none">– Do not try to light any appliance.– Do not touch any electrical switch; do not use any phone in your building.– Clear the room, building or area of all occupants.– Immediately call your gas supplier from a neighbor’s phone. Follow the gas supplier’s instructions.– If you cannot reach your gas supplier, call the fire department.• Installation and service must be performed by a qualified installer, service agency or the gas supplier. W052	
<p>FOR YOUR SAFETY</p> <p>Do not store or use gasoline or other flammable vapors and liquids in the vicinity of this or any other appliance. W053</p>	

	MISE EN GARDE
<p>POUR VOTRE SÉCURITÉ, les informations de ce guide doivent être respectées afin de réduire les risques d’incendie, d’explosion ou d’éviter les dommages matériels, personnels ou blessures mortelles. W033R3QU</p> <ul style="list-style-type: none">• Ne pas entreposer ni utiliser d’essence ni d’autres vapeurs ou liquides inflammables dans le voisinage de cet appareil ou de tout autre appareil.• QUE FAIRE SI VOUS SENTEZ UNE ODEUR DE GAZ<ul style="list-style-type: none">– Ne pas tenter d’allumer d’appareil.– Ne touchez à aucun interrupteur. Ne pas vous servir des téléphones se trouvant dans le bâtiment où vous vous trouvez.– Évacuez la pièce, le bâtiment ou la zone.– Appelez immédiatement votre fournisseur de gaz depuis un voisin. Suivez les instructions du fournisseur.– Si vous ne pouvez rejoindre le fournisseur de gaz, appelez le service des incendies.• L’installation et l’entretien doivent être assurés par un installateur ou un service d’entretien qualifié ou par le fournisseur de gaz. W052QU	
<p>POUR VOTRE SÉCURITÉ</p> <p>Ne pas entreposer ou utiliser d’essence ou toutes autres vapeurs et liquides inflammables à proximité de cette unité ou de tout autre appareil. W053B2QU</p>	

IMPORTANT: Information must be obtained from a local gas supplier on instructions to be followed if the user smells gas. These instructions must be posted in a prominent location. Step-by-step instructions of the above safety information must be posted in a prominent location near the tumbler for customer use.

Table of Contents

Introduction	3
Model Identification	3
Customer Service.....	4
Serial Plate Location.....	4
Wiring Diagram	4
Safety Information	5
Explanation of Safety Messages.....	5
Important Safety Instructions	6
Operating Instructions	8
Emergency Stop Button on CE Models.....	8
Operating Instructions	8
Control Instructions	9
Dual Digital Timer Control.....	9
Single Drop Control.....	11
Ignition Control Operation	13
Maintenance	15
Daily	15
Monthly.....	17
Quarterly	17
Bi-Annually	17
Before You Call for Service	20
Customer Service.....	20

© Copyright 2007, Alliance Laundry Systems LLC

All rights reserved. No part of the contents of this book may be reproduced or transmitted in any form or by any means without the expressed written consent of the publisher.

Introduction

Model Identification

Information in this manual is applicable to these models:

	Gas	Steam	Electric
T30	CHD30STG2-CAT30L CHD30STG2-CAT30N CHD30STG2-CTT30L CHD30STG2-CTT30N CHD30STG2-CUT30L CHD30STG2-CUT30N DRST30G2-BAT30L DRST30G2-BAT30N DRST30G2-BTT30L DRST30G2-BTT30N DRST30G2-BUT30L DRST30G2-BUT30N IPD30STG2-ITT30L IPD30STG2-ITT30N	CHD30STS2-CTT30S CHD30STS2-CUT30S DRST30S2-BTT30S DRST30S2-BUT30S IPD30STS2-ITT30S	CHD30STE2-CTT30E CHD30STE2-CUT30E DRST30E2-BTT30E DRST30E2-BUT30E IPD30STE2-ITT30E
T45	IPD45STG2-ITT45L IPD45STG2-ITT45N	Not Applicable	Not Applicable

Includes models with control suffixes:

3O – DX4 OPL
 3V – DX4 vended
 3X – DX4 prep for coin

QT – dual digital timer
 SD – single drop
 SX – single drop, prep for coin

Introduction

Customer Service

If literature or replacement parts are required, contact the source from which the machine was purchased or contact Alliance Laundry Systems at (920) 748-3950 for the name and address of the nearest authorized parts distributor.

For technical assistance, call (920) 748-3121.

Serial Plate Location

When calling or writing for information about your product, be sure to mention model and serial numbers. Model and serial numbers are found on serial plate on the rear of machine and inside door. Refer to *Figure 1*.

Wiring Diagram

The wiring diagram is located in the upper junction or upper contactor box. The wiring diagram part number is located in the lower portion of the electrical data on the serial plate.

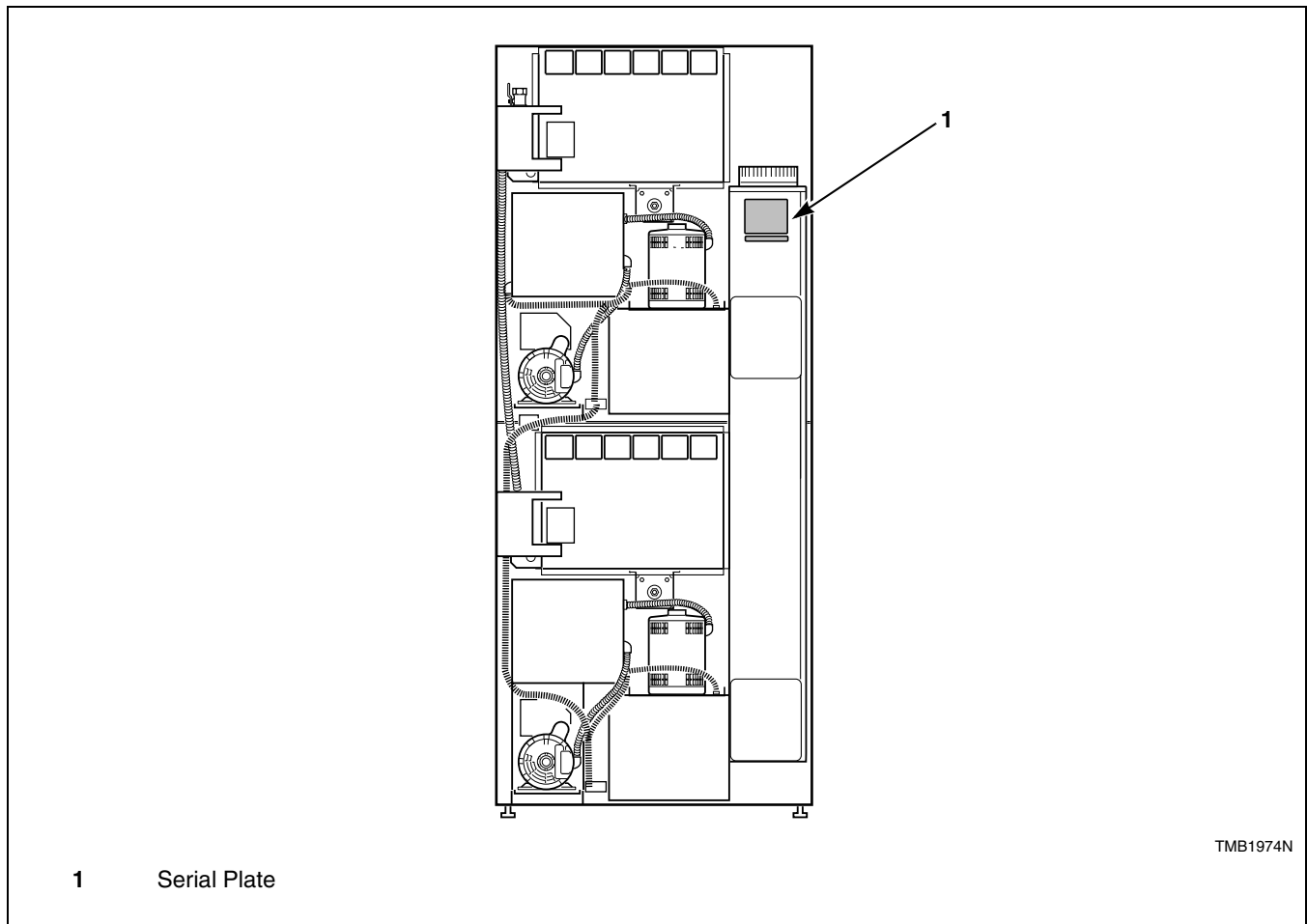



Figure 1

Safety Information

Explanation of Safety Messages

Precautionary statements (“DANGER,” “WARNING,” and “CAUTION”), followed by specific instructions, are found in this manual and on machine decals. These precautions are intended for the personal safety of the operator, user, servicer, and those maintaining the machine.

	DANGER
Indicates an imminently hazardous situation that, if not avoided, will cause severe personal injury or death.	

	WARNING
Indicates a hazardous situation that, if not avoided, could cause severe personal injury or death.	

	CAUTION
Indicates a hazardous situation that, if not avoided, may cause minor or moderate personal injury or property damage.	

Additional precautionary statements (“IMPORTANT” and “NOTE”) are followed by specific instructions.

IMPORTANT: The word “IMPORTANT” is used to inform the reader of specific procedures where minor machine damage will occur if the procedure is not followed.

NOTE: The word “NOTE” is used to communicate installation, operation, maintenance or servicing information that is important but not hazard related.

IMPORTANT: Warranty is void unless tumbler is installed according to instructions in the *Installation Manual*. Compliance with minimum specifications and requirements detailed herein, and with applicable local gas fitting regulations, municipal building codes, water supply regulations, electrical wiring regulations, and any other relevant statutory regulations. Because of varied requirements, applicable local codes should be thoroughly understood and all pre-installation work arranged for accordingly.

	WARNING
Failure to install, maintain, and/or operate this machine according to manufacturer’s instructions may result in conditions which can produce serious injury, death and/or property damage.	
W051R1	

NOTE: The WARNING and IMPORTANT instructions appearing in this manual are not meant to cover all possible conditions and situations that may occur. It must be understood that common sense, caution and carefulness are factors which CANNOT be built into this tumbler. These factors MUST BE supplied by the person(s) installing, maintaining or operating the tumbler.

Always contact your dealer, distributor, service agent or the manufacturer on any problems or conditions you do not understand.

Safety Information

Important Safety Instructions

Save These Instructions

	WARNING
Hazardous Voltage. Can cause shock, burn or cause death. Allow machine power to remain off for two minutes prior to working in and around AC inverter drive.	
W359	

1. Read all instructions before using the tumbler.
2. Refer to the **GROUNDING INSTRUCTIONS** for the proper grounding of the tumbler.
3. Do not dry articles that have been previously cleaned in, washed in, soaked in, or spotted with gasoline, dry cleaning solvents, other flammable or explosive substances as they give off vapors that could ignite or explode.
4. Do not allow children on or in the tumbler. This appliance is not intended for use by young children or infirm persons without supervision. Young children should be supervised to ensure that they do not play with the appliance.
5. Before the tumbler is removed from service or discarded, remove the door to the drying compartment and the door to the lint compartment.
6. Do not reach into the tumbler if the cylinder is revolving.
7. Do not install or store the tumbler where it will be exposed to water and/or weather.
8. Do not tamper with the controls.
9. Do not repair or replace any part of the tumbler, or attempt any servicing unless specifically recommended in the user-maintenance instructions or in published user-repair instructions that you understand and have the skills to carry out.
10. Do not use fabric softeners or products to eliminate static unless recommended by the manufacturer of the fabric softener or product.
11. To reduce the risk of fire, **DO NOT DRY** plastics or articles containing foam rubber or similarly textured rubberlike materials.
12. Always clean the lint filter daily.
13. Keep area around the exhaust opening and adjacent surrounding area free from the accumulation of lint, dust and dirt.
14. The interior of the tumbler and the exhaust duct should be cleaned periodically by qualified service personnel.
15. If not installed, operated and maintained in accordance with the manufacturer's instructions or if there is damage to or mishandling of this product's components, use of this product could expose you to substances in the fuel or from fuel combustion which can cause death or serious illness and which are known to the State of California to cause cancer, birth defects or other reproductive harm.
16. Tumbler will not operate with the loading door open. **DO NOT** bypass the door safety switch to permit the tumbler to operate with the door open. The tumbler will stop tumbling when the door is opened. Do not use the tumbler if it does not stop tumbling when the door is opened or starts tumbling without pressing or turning the START mechanism. Remove the tumbler from use and call for service.
17. Tumbler will not operate with lint panel open. **DO NOT** bypass lint panel safety switch to permit the tumbler to operate with the lint panel open.
18. Do not put articles soiled with vegetable or cooking oil in the tumbler, as these oils may not be removed during washing. Due to the remaining oil, the fabric may catch on fire by itself.
19. To reduce the risk of fire, **DO NOT** put clothes which have traces of any flammable substances such as machine oil, flammable chemicals, thinner, etc. or anything containing wax or chemicals such as in mops and cleaning cloths, or anything dry-cleaned at home with dry-cleaning solvent in the tumbler.
20. Use the tumbler only for its intended purpose, drying fabrics.
21. **ALWAYS** disconnect and lockout the electrical power to the tumbler before servicing. Disconnect power by shutting off appropriate breaker or fuse.
22. Install this tumbler according to the **INSTALLATION INSTRUCTIONS**. All connections for electrical power, grounding, and gas supply must comply with local codes and be made by licensed personnel when required.

Safety Information

23. Remove laundry immediately after tumbler stops.
24. Always read and follow manufacturer's instructions on packages of laundry and cleaning aids. Heed all warnings or precautions. To reduce the risk of poisoning or chemical burns, keep them out of reach of children at all times (preferably in a locked cabinet).
25. Do not tumble fiberglass curtains and draperies unless the label says it can be done. If they are dried, wipe out the cylinder with a damp cloth to remove particles of fiberglass.
26. Always follow the fabric care instructions supplied by the garment manufacturer.
27. Never operate the tumbler with any guards and/or panels removed.
28. **DO NOT** operate the tumbler if it is smoking, grinding, has missing or broken parts.
29. **DO NOT** bypass any safety devices.
30. Solvent vapors from dry-cleaning machines create acids when drawn through the heater of the drying unit. These acids are corrosive to the tumbler as well as to the laundry load being dried. Be sure make-up air is free of solvent vapors.
31. Failure to install, maintain, and/or operate this machine according to the manufacturer's instructions may result in conditions which can produce bodily injury and/or property damage.



WARNING

To reduce the risk of serious injury, install lockable door(s) to prevent public access to rear of tumblers.

W055

Operating Instructions



WARNING

To reduce the risk of fire:

- **DO NOT DRY** articles containing foam rubber or similarly textured rubberlike materials.
- **DO NOT DRY** plastics, anything containing wax or chemicals such as mops and cleaning cloths, or anything dry-cleaned at home with a dry-cleaning solvent.
- **DO NOT TUMBLE** fiberglass curtains and draperies unless the label says it can be done. If they are dried, wipe out the cylinder with a damp cloth to remove particles of fiberglass.

W076

To reduce the risk of serious injury, allow cylinder to stop before cleaning lint screen.

W412

Emergency Stop Button on CE Models

All CE approved OPL tumblers are factory equipped with an emergency stop button located on the front panel. Refer to *Figure 2*.

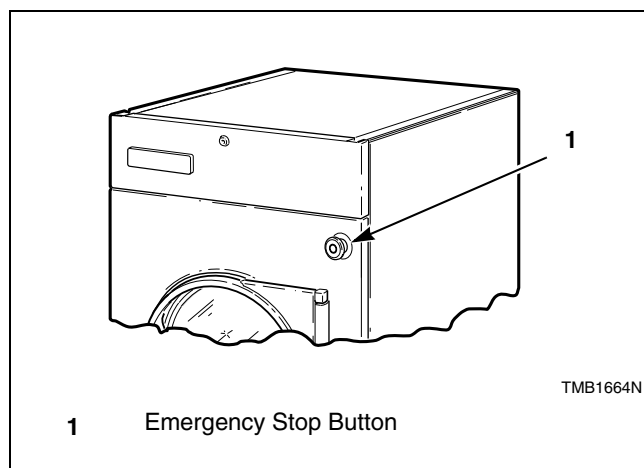

Figure 2

To operate emergency stop button:

- a. Press red emergency stop button to stop all action.
- b. To restart machine, pull red emergency stop button out and press START pad or button.

NOTE: Activation of the emergency stop button stops all machine control circuit functions, but DOES NOT remove all electrical power from machine.

Operating Instructions

Step 1: Clean Lint Screen/Compartment

Remove any accumulated lint from the lint screen and compartment. Close panel tightly against tumbler frame and lock panel securely, if applicable.

IMPORTANT: Clean lint screen and lint compartment daily. Failure to clean the lint screen daily will result in higher than normal temperatures that may damage laundry.

Step 2: Load Laundry

Open loading door and load cylinder with laundry. **DO NOT OVERLOAD.**

NOTE: Overloading causes slow drying and wrinkling.

Close loading door. Tumbler will not operate with the door open.

Step 3: Determine Control Type and Temperature Setting

Refer to the various controls, pages page 9 - 12, follow instructions for the appropriate control type.

Use the correct coin slot and control panel for the top or bottom cylinder.

The type of fabric being dried will determine the temperature setting. Consult the fabric care label or fabric manufacturer to determine proper temperature setting.

IMPORTANT: Always follow the fabric care instructions supplied by the garment manufacturer.

Step 4: Remove Laundry

When the cycle is complete, open door and remove the laundry.

Control Instructions

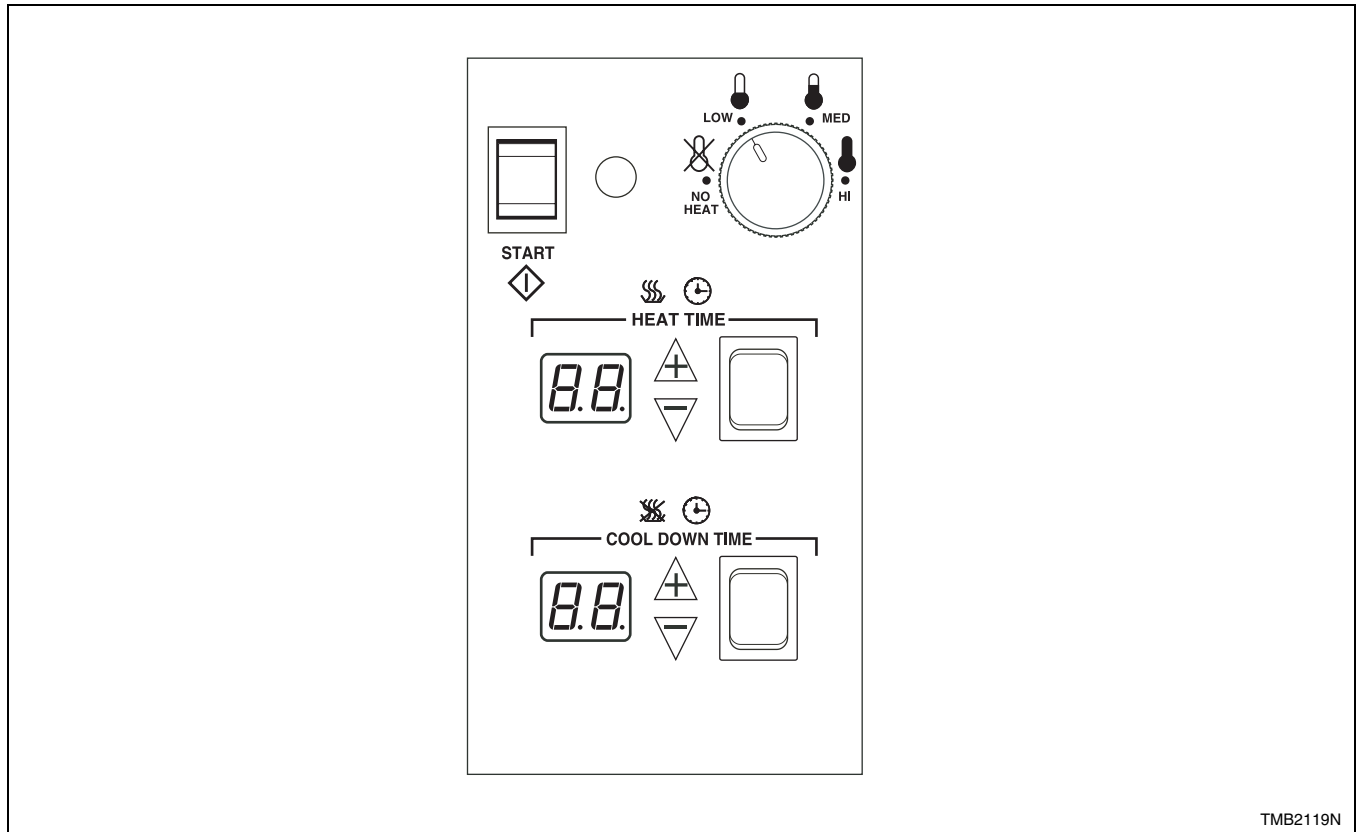

Figure 3

Dual Digital Timer Control

QT Control Suffix

1. Select HIGH, MED, LOW or NO HEAT by turning the temperature knob.
2. Set the HEAT TIME for the number of minutes (from 0-60) desired.
3. Set the COOL DOWN TIME for the number of minutes (from 0-15) desired.
4. Press and release START button to start tumbler. Display will show minutes remaining before end of cycle.

NOTE: One touch drying is available for repetitive loads. If the START button is pressed while the machine is in Idle Mode, when the display is dark, the tumbler will repeat the last drying cycle. If the cycle time is adjusted before the cycle is started, the time displayed when the start button was pressed will be used for future cycles.

IMPORTANT: To stop the tumbler at any time during the cycle, OPEN DOOR. If the loading door or lint panel door is opened during the cycle, the heating system will shut off and the motor will stop. To restart the cycle, both doors must be closed and the START button must be pressed in.

If the load cools to 90° F before cool down time expires, the control will flash “Lr” (load ready) in the heat time display. If the door is not opened, the tumbler completes the selected cool down time. If the door is opened after reaching “Lr” temperature, the cycle will be terminated.

NOTE: If display show an error code, refer to *Error Codes* section.

5. When the cycle is complete, open door and remove the laundry. Anti-wrinkle feature will tumble the load without heat for 30 seconds every 2 minutes for 1 hour OR until the loading door is opened.

NOTE: This machine includes an anti-wrinkle/extended tumble feature. After the drying cycle is complete, the cylinder will tumble without heat every few minutes. The intermittent tumbling will continue for one hour or until the door is opened.

Operating Instructions

Error Codes

	WARNING
<p>To reduce the risk of electric shock, fire, explosion, serious injury or death:</p> <ul style="list-style-type: none"> • Disconnect electric power to the tumbler before servicing. • Close gas shut-off valve to gas tumbler before servicing. • Close steam valve to steam tumbler before servicing. • Never start the tumbler with any guards/panels removed. • Whenever ground wires are removed during servicing, these ground wires must be reconnected to ensure that the tumbler is properly grounded. 	
W002	

Display	Definition	Corrective Action
OP	Open thermistor error	<ul style="list-style-type: none"> • Check thermistor. Replace if inoperative. • Check wiring diagram between control and thermistor. Refer to wiring diagram for proper wiring. • Check control. Replace if inoperative.
SH	Shorted thermistor error	<ul style="list-style-type: none"> • Check thermistor. Replace if inoperative. • Check wiring between control and thermistor. Refer to wiring diagram for proper wiring. • Check control. Replace if inoperative.
AF - 1	Airflow switch closed when cycle started	<ul style="list-style-type: none"> • Check airflow switch. Replace if inoperative.
AF - 2	Airflow switch failed to close after cycle started	<ul style="list-style-type: none"> • Check airflow switch. Replace if inoperative.

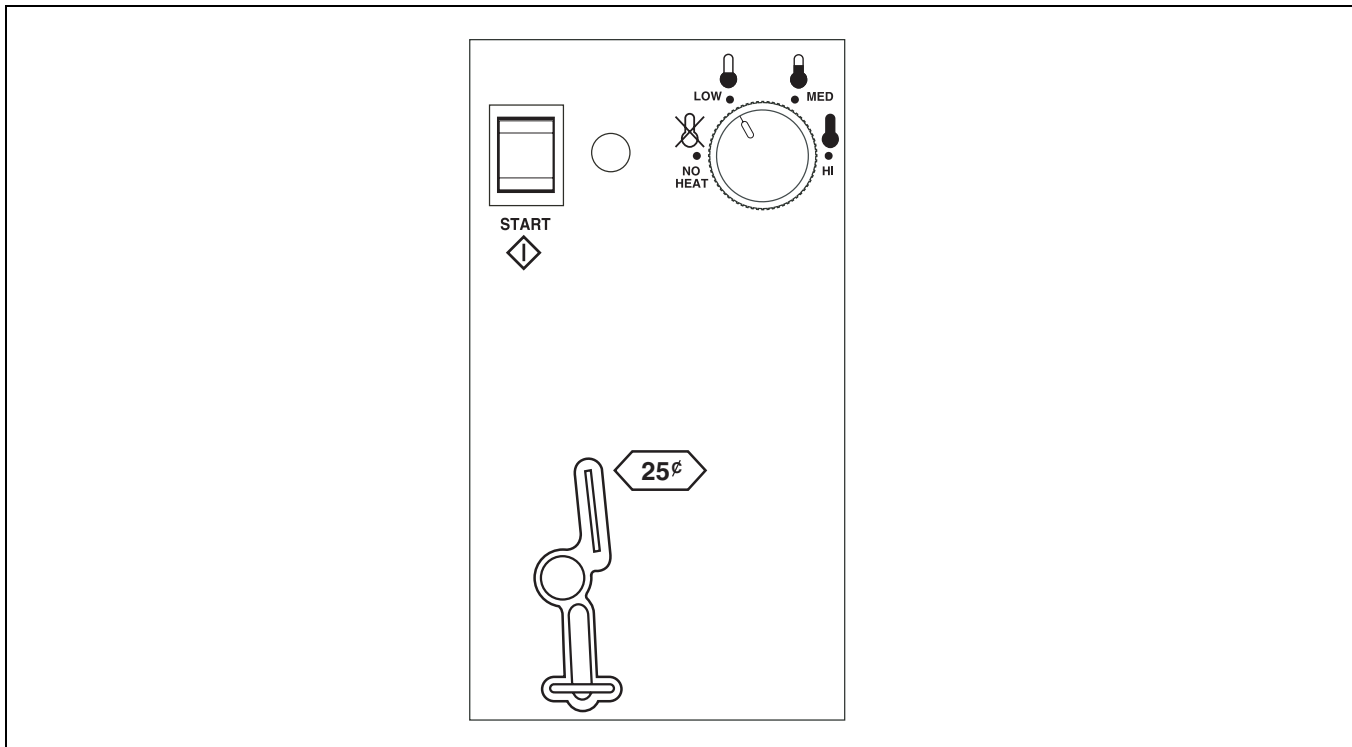

Figure 4

Single Drop Control

SD and SX Control Suffixes

1. Select HIGH, MED, LOW or NO HEAT by turning the temperature knob.
2. Insert the coin(s) in the coin slot.
3. Press START button to start tumbler.

IMPORTANT: To stop the tumbler at any time during the cycle, OPEN DOOR. To restart the tumbler, CLOSE door and press START button.

NOTE: If display show an error code, refer to *Error Codes* section.

4. When the cycle is complete, open door and remove the laundry.

NOTE: This machine includes an extended tumble feature. Starting 20 minutes after a cycle ends, the cylinder will tumble for two minutes every hour without heat, up to 18 hours or until door is opened.

Preliminary Control Information

Power-Up Mode

When power is applied to the tumbler the control will enter Ready Mode, unless a cycle was in process prior to a disruption of power. If a power disruption is less than 5 seconds, with a cycle in process, the control will enter Run Mode once power is restored and continue the cycle. If a power disruption is more than 5 seconds, with a cycle in process, the control will enter Start Mode once power is restored.

If the dry time dipswitch settings have not changed from the factory default, the *IN USE* LED will flash two to five times, depending on model.

Ready Mode

In Ready Mode, the control waits for the vend to be satisfied before entering Start Mode.

Start Mode

In Start Mode, the vend has been satisfied, but the Start button has not been pressed. The *IN USE* LED will be lit. The timer will not count down until the Start button is pressed.

Operating Instructions

Run Mode

In Run Mode, the control is running a cycle. The *IN USE* LED is lit.

Door Open Mode

In Door Open Mode, the control turns off the heater and motor when the door is opened during a run cycle. The timer will continue to count down time and the *IN USE* LED is lit.

End of Cycle Mode

In End of Cycle Mode, a cycle is complete and the *IN USE* LED is off. The control remains in this mode until the door is opened or additional vend has been satisfied

Topoffs

Any time the control receives a coin drop pulse during a cycle it will add the programmed dry time to the time currently remaining in the cycle. The maximum cycle time is 99 minutes, the control will not add time beyond 99 minutes. The cool down time will not change.

Error Codes

If the control receives a coin drop pulse during cool down the *IN USE* LED will flash briefly to indicate the coin input, the machine will exit cool down and it will start heating. The cycle time will be equal to the programmed dry time

Temperature Selector Switch

For five minutes after the control is powered up, there is a diagnostic feature that allows the temperature selector switches to be tested.

When the temperature selector is changed, the new setting is displayed by flashing the *IN USE* LED as follows:

High/Normal: 4 flashes

Medium/PP: 3 flashes

Low/Delicate: 2 flashes

No Heat: 1 flash

NOTE: To change dipswitch settings refer to *Installation Manual*.



WARNING

To reduce the risk of electric shock, fire, explosion, serious injury or death:

- **Disconnect electric power to the tumbler before servicing.**
- **Close gas shut-off valve to gas tumbler before servicing.**
- **Close steam valve to steam tumbler before servicing.**
- **Never start the tumbler with any guards/panels removed.**
- **Whenever ground wires are removed during servicing, these ground wires must be reconnected to ensure that the tumbler is properly grounded.**

W002

Display	Definition	Corrective Action
AF (flashing)	Airflow switch opened/closed 5 or more times in a running cycle.	<ul style="list-style-type: none"> • Check airflow switch. Replace if inoperative.

Ignition Control Operation

Power Up

After 24 VAC is applied to the ignition control pins 24V and GND, the Diagnostic LED on the ignition control will turn orange/yellow. If a fault is detected the ignition control will enter Lockout Mode. If no faults are detected, the Diagnostic LED will turn Green and the ignition control will enter Standby Mode.

Standby Mode

While in Standby Mode, the ignition control will continually monitor the system for faults. Once 24VAC is applied to terminals TH and GND on the control, the ignition control will enter Start Up Mode.

Start Up Mode

During Start Up Mode, the ignition control will monitor the system for faults and begin the ignition sequence. If no faults are present, the ignition control will begin the ignition sequence by entering an 18 second waiting period. During this time the Green LED on the ignition control will switch between Red and Green, before maintaining a Green color.

After the waiting period, the ignition control will turn on the igniter and gas valve. The igniter will remain on until a flame is sensed, or up to 10 seconds.

Once a flame has been sensed the ignition control will stop sparking, the gas valve will remain on and ignition control will enter Run Mode.

If a flame is not sensed, the ignition control will then begin two additional retrials for ignition. The ignition control will re-enter the 18 seconds waiting period before the ignition control makes another attempt at ignition. If the three attempts at ignition fail, the ignition control will enter Lockout Mode.

Run Mode

While in Run Mode the ignition control leaves the gas valve on, monitors the flame signal, and leaves the igniter off.

If a flame signal is lost during Run Mode, one additional retrial for ignition will take place within one second. The ignition control will restore the spark for approximately 10 seconds. If the ignition re-attempt fails, the ignition control will enter Lockout Mode.

The ignition control will remain in Run Mode until 24VAC is removed from terminals TH and GND on the control.

Termination of Flame

The flame will go out when power is removed from ignition control. The ignition control will turn off the gas valve and enter Standby Mode.

Lockout Mode

When Lockout Mode is entered, the ignition control will remove power to the gas valve, the igniter will turn off, the Lockout/Reset Light will turn on, and the Diagnostic LED will display the appropriate Error Code.

Lockout Manual Reset

Lockout Mode is cleared by pressing an external reset switch for three seconds. The ignition control will clear all error codes and enter Standby Mode. During Lockout Manual Reset, the Diagnostic LED on the ignition control flashes red and orange, and the Reset Light remains on until the ignition control is reset. After the Reset Light turns off, stop pressing the switch. Holding the reset for three seconds after lockout has been cleared will cause a fault and result in entering Lockout Mode again.

Operating Instructions

System Tests

The following system tests are performed during normal operation. System tests are performed at a minimum of every 24 hours.

Low Voltage Detection

If the voltage between terminals TH and GND on the control is below 18.75VAC +/- 0.75VAC for more than 3 seconds the ignition control will turn off the gas valve and will not attempt to spark. The Diagnostic LED will display Error Code 5. The ignition control will not enter Lockout Mode if a low voltage condition is detected, but will enter Standby Mode and wait for the low voltage condition to be cleared.

If the voltage between terminals TH and GND on the control rises above 19.75VAC +/- 0.1VAC for at least 3 seconds, the ignition control will then enter Start Up Mode.

Low Voltage Detection test is disabled during Run Mode.

Gas Valve

The ignition control verifies that the gas valve is connected. Failure of this test results in the ignition control entering Lockout Mode with the Diagnostic LED displaying Error Code 2.

Flame Probe Tests

Unexpected Presence of Flame

The Unexpected Presence of Flame test is performed when no flame is expected. Failure of this test results in the ignition control entering Lockout Mode with the Diagnostic LED displaying Error Code 3.

Flame Monitoring

During the Flame Monitoring test, the flame is checked to ensure the gas is being burned when the gas valve is on. Failure of this test will result in the ignition control entering Lockout Mode with the Diagnostic LED displaying Error Code 3.

Diagnostic LED (DGN LED) / Error Codes

The Diagnostic LED or DGN LED is located by the power connector on the ignition control. Refer to *Figure 5*. The Diagnostic LED will indicate the status of the ignition control. Refer to *Table 1*.

LED Color	Description
Orange-Yellow	Initialization
Green	Standby / Normal Operation
Red	Fault Indication Code

Table 1

The Diagnostic LED will flash error codes one half second on and one half second off. Error codes are separated by a one second pause before the code is repeated.

Error Code	DGN LED status	Fault Type
1	Red	Ignition Control Internal Failure
2	2 Red Flashes	Gas Valve Not Connected
3	3 Red Flashes	Ignition/Flame Sense Failure
4	4 Red Flashes	Reset Switch is Shorted
5	Slow Red and Green Flashes	Low Voltage Detection
6	Fast Red and Orange Flashes	Ignition Control is in Reset Delay

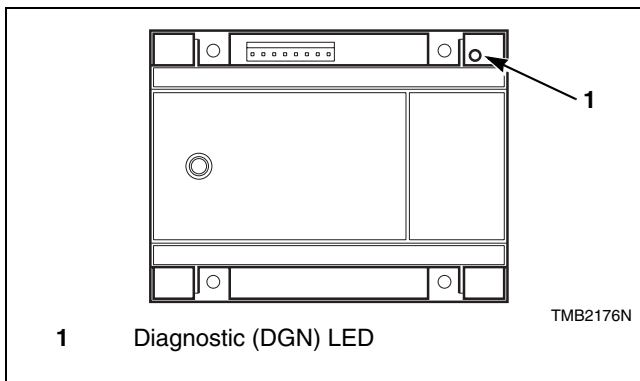

Figure 5

Maintenance



WARNING

To reduce the risk of electric shock, fire, explosion, serious injury or death:

- **Disconnect electric power to the tumbler before servicing.**
- **Close gas shut-off valve to gas tumbler before servicing.**
- **Close steam valve to steam tumbler before servicing.**
- **Never start the tumbler with any guards/panels removed.**
- **Whenever ground wires are removed during servicing, these ground wires must be reconnected to ensure that the tumbler is properly grounded.**

W002

Daily

1. Inspect the area surrounding tumblers, remove all combustible materials, including lint, before operating the machine.
 2. Check cylinder for foreign objects to avoid damage to clothing and equipment.
 3. Clean lint from lint compartment and screen to maintain proper airflow and to avoid overheating.
- a. Unlock and pull out lint drawer.
 - b. Remove all accumulated lint in the lint compartment area. Lightly brush any lint that may be left on the lint screen. Lint left in the lint compartment is drawn back onto the lint screen and will restrict airflow.
 - c. Be sure the lint screen is not torn. If it is, replace immediately. A torn lint screen allows lint to pass from the tumbler to the ductwork system and may restrict airflow.
 - d. The lint screen is designed to completely cover the entire opening in the lint screen panel. Be sure that it does so. Excessive gaps between the lint screen and the lint screen panel allow lint to pass into the ductwork system and may restrict airflow.
 - e. Carefully wipe any accumulated lint off the cabinet thermostat and thermistor. Failure to do so will allow a buildup of lint in this area to act as an insulator, causing the tumbler to overheat. Refer to *Figure 6*.
 - f. Replace the lint drawer ensuring a tight fit, and lock.



WARNING

To reduce the risk of serious injury, do not open the lint panel while the tumbler is in operation. Before cleaning the lint screen, open tumbler door and allow cylinder to completely stop.

W410



WARNING

To reduce the risk of electric shock, fire, explosion, serious injury or death:

- Disconnect electric power to the tumbler before servicing.
- Close gas shut-off valve to gas tumbler before servicing.
- Close steam valve to steam tumbler before servicing.
- Never start the tumbler with any guards/panels removed.
- Whenever ground wires are removed during servicing, these ground wires must be reconnected to ensure that the tumbler is properly grounded.

W002

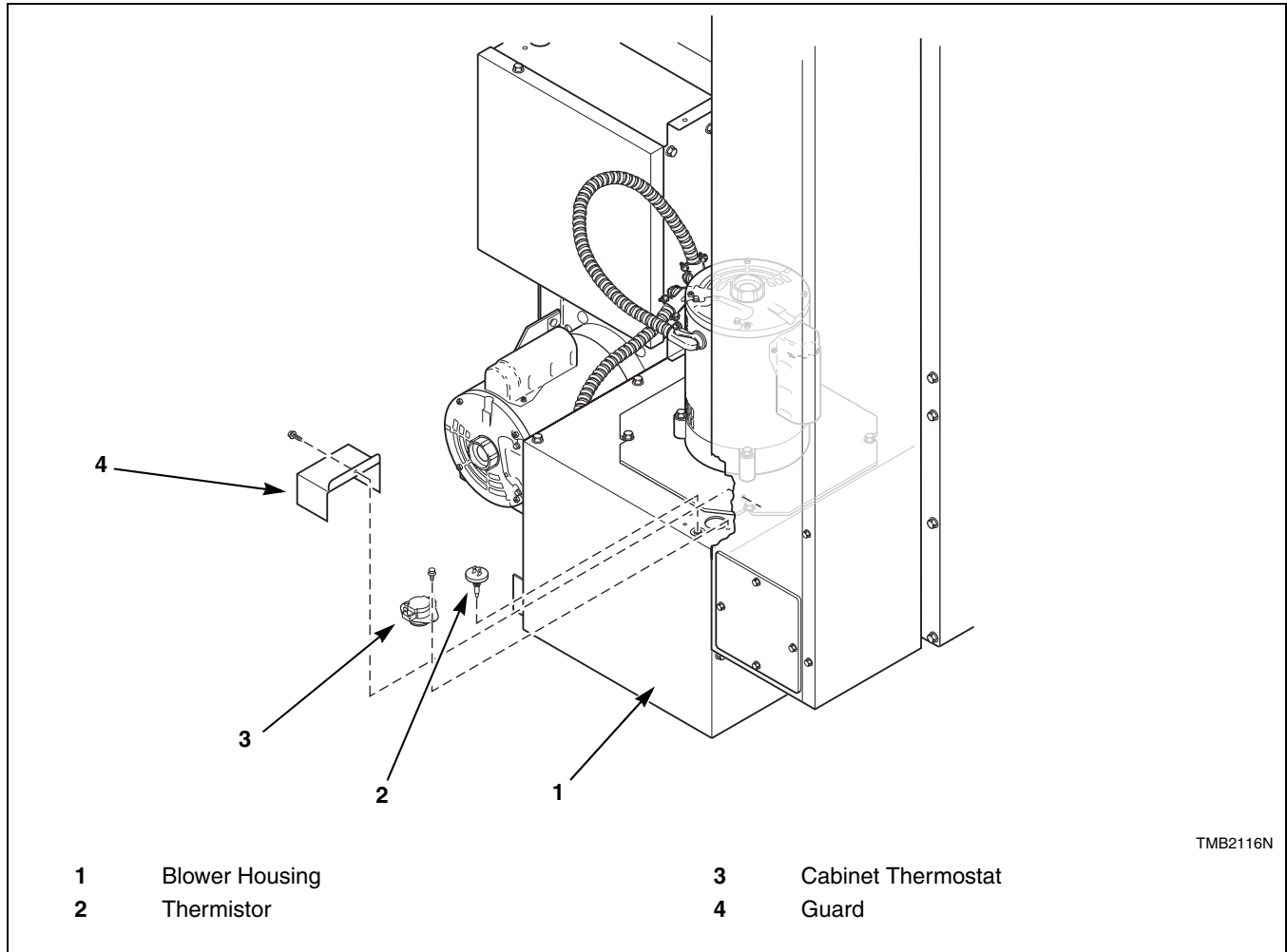

TMB2116N

Figure 6



WARNING

To reduce the risk of electric shock, fire, explosion, serious injury or death:

- **Disconnect electric power to the tumbler before servicing.**
- **Close gas shut-off valve to gas tumbler before servicing.**
- **Close steam valve to steam tumbler before servicing.**
- **Never start the tumbler with any guards/panels removed.**
- **Whenever ground wires are removed during servicing, these ground wires must be reconnected to ensure that the tumbler is properly grounded.**

W002

Monthly

1. Remove lint and debris from inside exhaust duct to maintain proper airflow and avoid overheating.
 - a. Remove external duct and duct access covers, if present.
 - b. Clean inside of duct with a vacuum.
 - c. Clean dampers and make sure they operate freely.
 - d. Replace duct and all access covers before returning tumbler to operation.
2. Ensure even lint distribution over lint screen, replace if distribution of lint is uneven to maintain proper airflow and avoid overheating.
3. Carefully wipe any accumulated lint off the cabinet high limit thermostat and thermistor, including perforated cover. Lint buildup will act as an insulator, causing machine to overheat.
4. Clean lint and debris buildup from blower to maintain proper airflow, avoid overheating and prevent possible vibration.

Bi-Annually

1. Check mounting hardware for any loose nuts, bolts or screws.
2. Check gas connections for leakage.
3. Check for loose electrical connections.
4. Check steam connections for looseness and leakage.
5. Remove all front panels and vacuum, including coin drop mechanisms.
6. Check cylinder and front panel seals.
7. Inspect cabinet and inner panels for any damage, replace or repair as needed.
8. Clean burner tubes of any lint buildup.

Quarterly

1. Use a vacuum to clean air vents on drive motors.
2. Use a vacuum to clean lint from rear limit thermostat cover.
3. Check and clean steam coils, if applicable.
4. Check flow of combustion and ventilation air.
5. Check belt tension and condition. Replace worn or cracked belts.

Maintenance

	WARNING
<p>To reduce the risk of electric shock, fire, explosion, serious injury or death:</p> <ul style="list-style-type: none"> • Disconnect electric power to the tumbler before servicing. • Close gas shut-off valve to gas tumbler before servicing. • Close steam valve to steam tumbler before servicing. • Never start the tumbler with any guards/panels removed. • Whenever ground wires are removed during servicing, these ground wires must be reconnected to ensure that the tumbler is properly grounded. 	
W002	

Daily Maintenance

Inspect the area surrounding tumblers, remove all combustible materials, including lint, before operating the machine.								
Check cylinder for foreign objects to avoid damage to clothing and equipment.								
Clean lint from lint compartment and screen to maintain proper airflow and avoid overheating.								

Monthly Maintenance

Remove lint and debris from inside exhaust duct to maintain proper airflow and avoid overheating.								
Ensure even lint distribution over lint screen, replace if distribution of lint is uneven to maintain proper airflow and avoid overheating.								
Carefully wipe any accumulated lint off the cabinet high limit thermostat and thermistor, including perforated cover. Lint buildup will act as an insulator, causing machine to overheat.								
Clean lint and debris buildup from blower to maintain proper airflow, avoid overheating and prevent possible vibration.								



WARNING

To reduce the risk of electric shock, fire, explosion, serious injury or death:

- **Disconnect electric power to the tumbler before servicing.**
- **Close gas shut-off valve to gas tumbler before servicing.**
- **Close steam valve to steam tumbler before servicing.**
- **Never start the tumbler with any guards/panels removed.**
- **Whenever ground wires are removed during servicing, these ground wires must be reconnected to ensure that the tumbler is properly grounded.**

W002

Quarterly Maintenance

Use a vacuum to clean air vents on drive motors.								
Use a vacuum to clean lint from rear limit thermostat cover.								
Check and clean steam coils, if applicable.								
Check flow of combustion and ventilation air.								
Check belt tension and condition. Replace worn or cracked belts.								

Bi-Annually Maintenance

Check mounting hardware for any loose nuts, bolts or screws.								
Check gas connections for leakage.								
Check for loose electrical connections.								
Check steam connections for looseness and leakage.								
Remove all front panels and vacuum, including coin drop mechanisms.								
Check cylinder and front panel seals.								
Inspect cabinet and inner panels for any damage, replace or repair as needed.								
Clean burner tubes of any lint buildup.								

Before You Call for Service

Won't Start	Won't Heat	Clothes Not Dry	Possible Reason – Corrective Actions
•			Insert correct coin(s) or valid card if applicable.
•			Close the loading door tightly.
•			Close lint panel tightly.
•			Press the START pad/button.
•			Be sure power is supplied to the machine.
•			Check the main fuse and circuit breaker.
•			Check fuses located in the machine.
	•		Insufficient airflow.
	•		Gas shut-off valve in OFF position.
	•		Are controls properly set?
	•	•	Tumbler is in Cool Down Mode.
	•	•	Lint screen clogged. Clean lint screen.
	•	•	Exhaust duct to outside is blocked. Clean out.

Customer Service

If literature or replacement parts are required, contact the source from which the machine was purchased or contact Alliance Laundry Systems at (920) 748-3950 for the name and address of the nearest authorized parts distributor.

For technical assistance, call (920) 748-3121.