

**SAMSUNG**

**OWNER'S INSTRUCTIONS &  
INSTALLATION MANUAL**

**MANUAL DE INSTRUCCIONES &  
MANUAL DE INSTALACIÓN**

**MANUEL D'UTILISATION &  
MANUEL D'INSTALLATION**

**Indoor Unit  
ACC2400C  
ACC2800C**

**Outdoor Unit  
UCC2400C  
UCC2800C**

ENGLISH

**Cassette-type Air Conditioner (Cool)  
Aire acondicionado Tipo Casete (Refrigeración)  
Climatiseur de type Cassette (Refroidissement)**

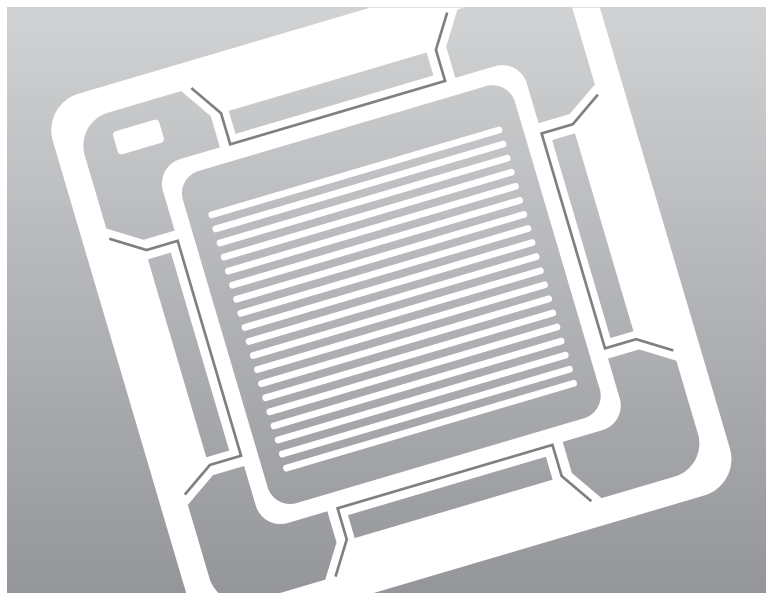

## Before Starting

*The wired remote controller, wireless remote controller and Centralized controller of the air conditioner are optional accessories. And your Owner's Instructions is for all of them. So that before using this instruction, ensure your option(s).*

## Safety Precautions



### WARNING

- ◆ If the power supply cord of this air conditioner is damaged, it must be replaced by the manufacturer or its authorized service personnel only in order to avoid a safety hazard.



### DANGER

- ◆ Do not attempt to install this air conditioner by yourself.
- ◆ This unit contains no user-serviceable parts. Always consult authorized service personnel for repairs.
- ◆ When moving, consult authorized service personnel for disconnection and installation of the unit.
- ◆ Do not become over-exposed to cold air by staying in the direct path of the airflow of the air conditioner for extended periods of time.
- ◆ Do not insert fingers or objects into the outlet port or intake grilles.
- ◆ Do not start and stop air conditioner operation by disconnecting the power supply cord and so on.
- ◆ Take care not to damage the power supply cord.
- ◆ In the event of a malfunction (burning smell, etc.), immediately stop operation, turn off the electrical breaker, and consult authorized service personnel.



### CAUTION

- ◆ Provide occasional ventilation during use.
- ◆ Do not direct air flow at fireplaces or heating apparatus.
- ◆ Do not climb on, or place objects on, the air conditioner.
- ◆ Do not hang objects from the indoor unit.
- ◆ Do not set flower vases or water containers on top of air conditioners.
- ◆ Do not expose the air conditioner directly to water.
- ◆ Do not operate the air conditioner with wet hands.
- ◆ Do not pull power supply cord.
- ◆ Turn off power source when not using the unit for extended periods.
- ◆ Check the condition of the installation stand for damage.
- ◆ Do not place animals or plants in the direct path of the air flow.
- ◆ Do not drink the water drained from the air conditioner.
- ◆ Do not use in applications involving the storage of foods, plants or animals, precision equipment, or art works.
- ◆ Do not apply any heavy pressure to radiator fins.
- ◆ Operate only with air filters installed.
- ◆ Do not block or cover the intake grille and outlet port.
- ◆ Ensure that any electronic equipment is at least one metre away from either the indoor or outdoor units.
- ◆ Avoid installing the air conditioner near a fireplace or other heating apparatus.
- ◆ When installing the indoor and outdoor unit, take precautions to prevent access to infants.
- ◆ Do not use inflammable gases near the air conditioner.

# Contents

- ◆ **PREPARING YOUR AIR CONDITIONER**
  - Before Starting ..... 2
  - Safety Precautions ..... 2
  - View of the Unit ..... 4
  - Wired Remote Controller-Buttons and Display ..... 6
  - Wireless Remote Controller-Buttons and Display ..... 7
  - Centralized Controller ..... 8
  - The Indicators on the Unit (For Wireless Remote Controller Only) ..... 9
  - Getting Start ..... 10
  - Inserting the Wireless Remote Controller Batteries ..... 11

**USING WIRED REMOTE CONTROLLER**

- ◆ **OPERATING YOUR AIR CONDITIONER**
  - Selecting the Automatic Operating Mode ..... 13
  - Cooling Your Room ..... 14
  - Removing Excess Humidity ..... 15
  - Airing Your Room ..... 16
  - Adjusting the Air Flow Direction ..... 17
- ◆ **PROGRAMMING YOUR AIR CONDITIONER**
  - Setting the On Timer ..... 18
  - Setting the Off Timer ..... 19

**USING WIRELESS REMOTE CONTROLLER**

- ◆ **OPERATING YOUR AIR CONDITIONER**
  - Selecting the Automatic Operating Mode ..... 21
  - Cooling Your Room ..... 22
  - Removing Excess Humidity ..... 23
  - Airing Your Room ..... 24
  - Adjusting the Air Flow Direction ..... 25
- ◆ **PROGRAMMING YOUR AIR CONDITIONER**
  - Setting the On Timer ..... 26
  - Setting the Off Timer ..... 27

**USING CENTRALIZED CONTROLLER**

- Using the Centralized Controller ..... 28

- ◆ **RECOMMENDATIONS FOR USE**
  - Operating Recommendations ..... 29
  - Temperature and Humidity Ranges ..... 29
  - Cleaning Your Air Conditioner ..... 30
  - Bio-Pure Filter Installation(Optional) ..... 31
  - Solving Common Problems ..... 32

- ◆ **SPECIFICATIONS** ..... 33

- ◆ **INSTALLATION MANUAL** ..... 34

## View of the Unit

The figures are shown in this instruction may differ from yours depending on the model.

### *Indoor Unit*

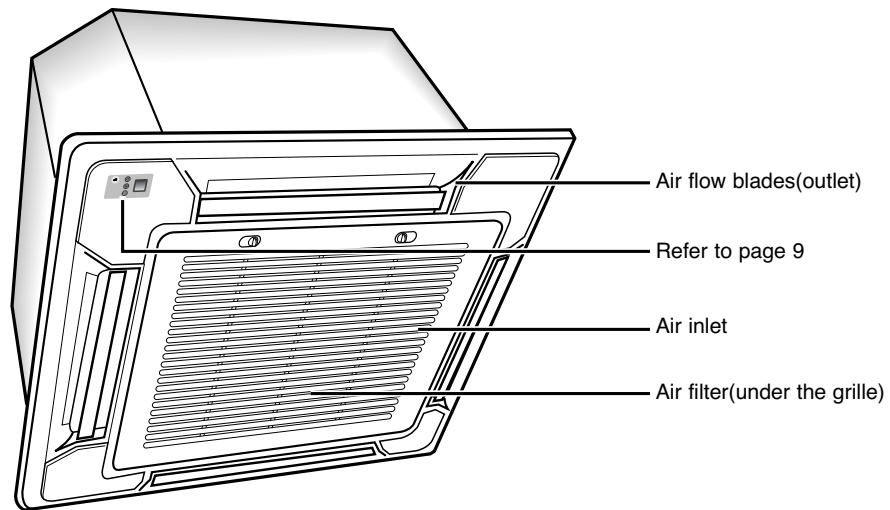

**Outdoor Unit**

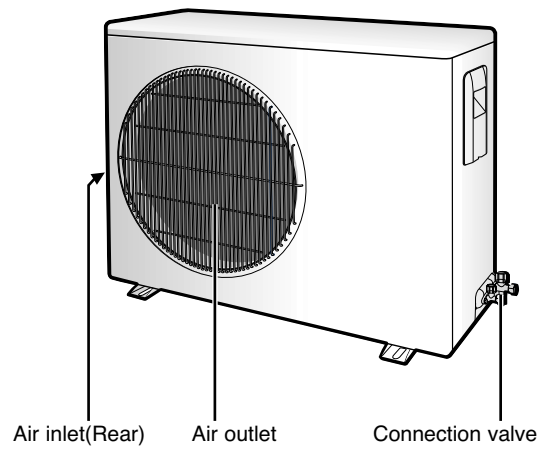

## Wired Remote Controller-Buttons and Display

The wired remote controller is an optional accessory.

The wired remote controller is installed on the wall.

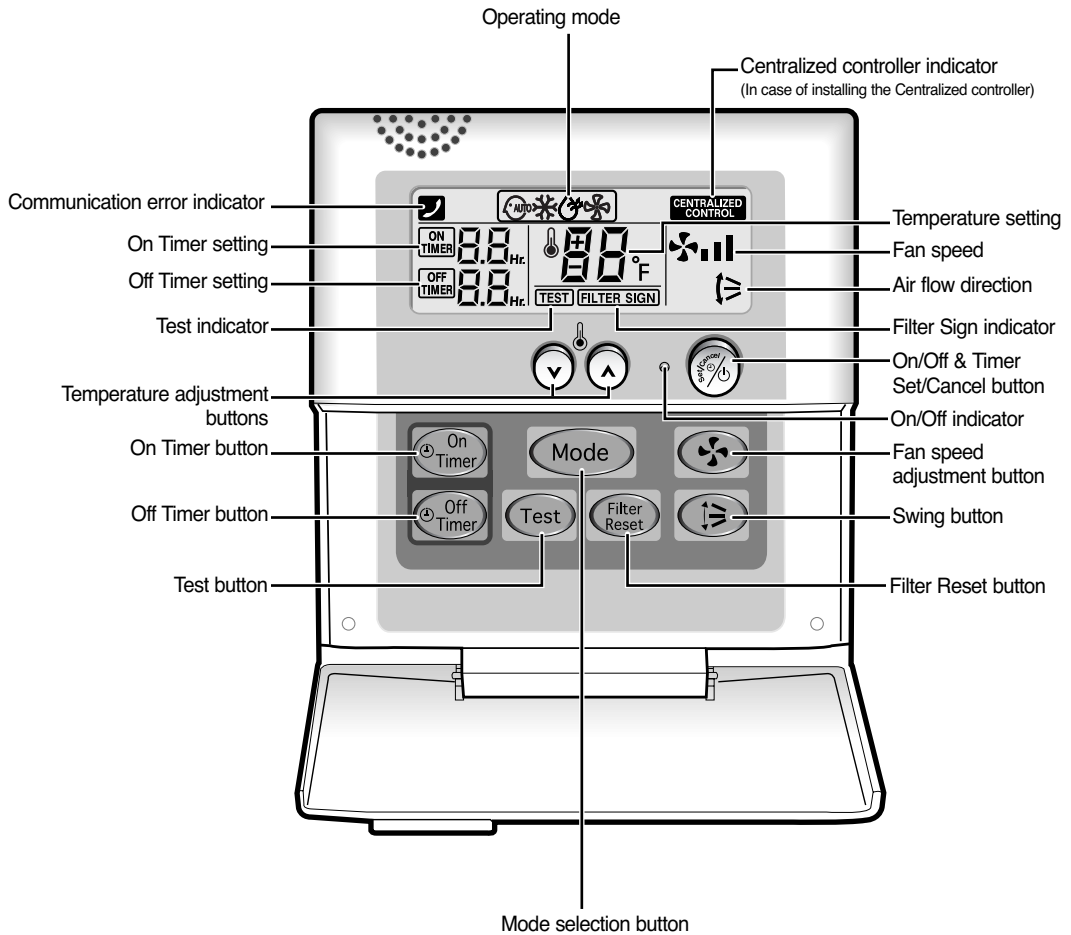

- Note**
- Test button is for your installation specialist. You must NOT press it.
  - After cleaning the air filter, press the filter reset button. Then the wired remote controller will display the FILTER SIGN indicator when the time will display the FILTER SIGN indicator when the time to clean the air filter; refer to page 30.

## Wireless Remote Controller-Buttons and Display

The wireless remote controller is an optional accessory.

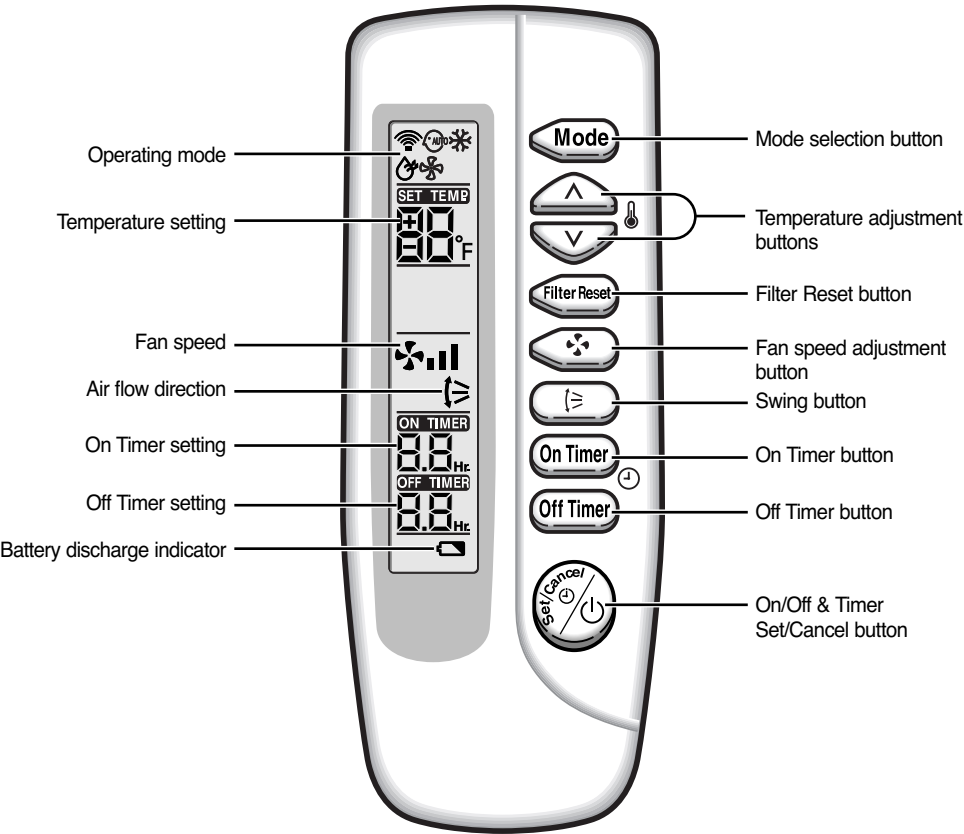

**Note** After cleaning the air filter, press the filter reset button.

## Centralized Controller

The centralized controller is an optional accessory.

The centralized controller is installed on the wall.

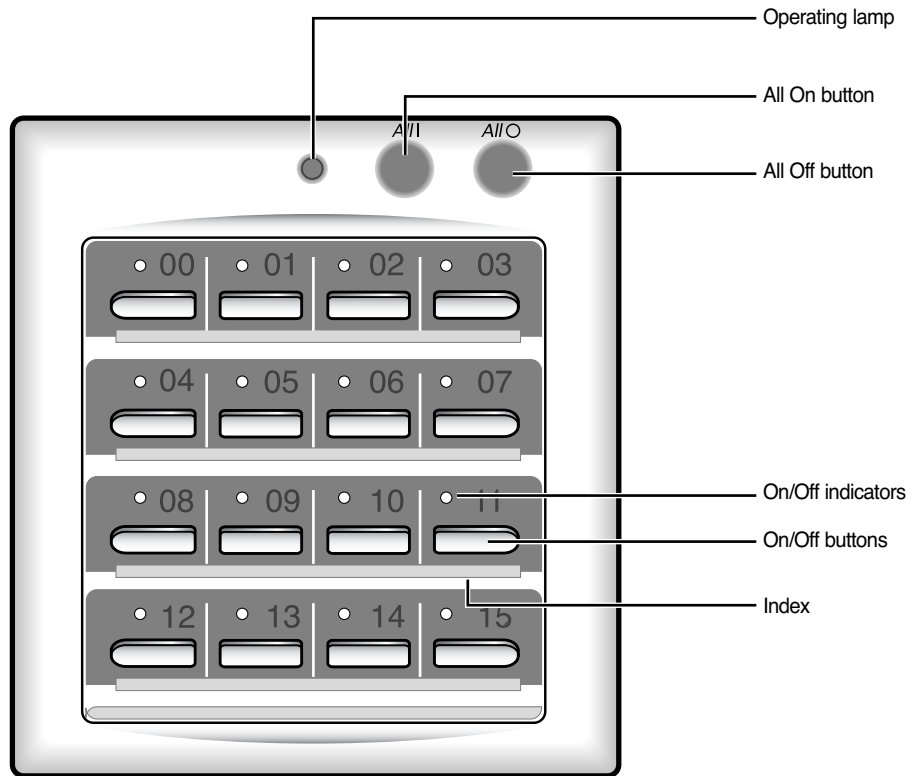

**Note** Operating lamp comes on when at least one air conditioner connected to the centralized controller is operating.



## The Indicators on the Unit (For Wireless Remote Controller Only)

The receiver & display unit is an optional accessory for the wireless remote controller.

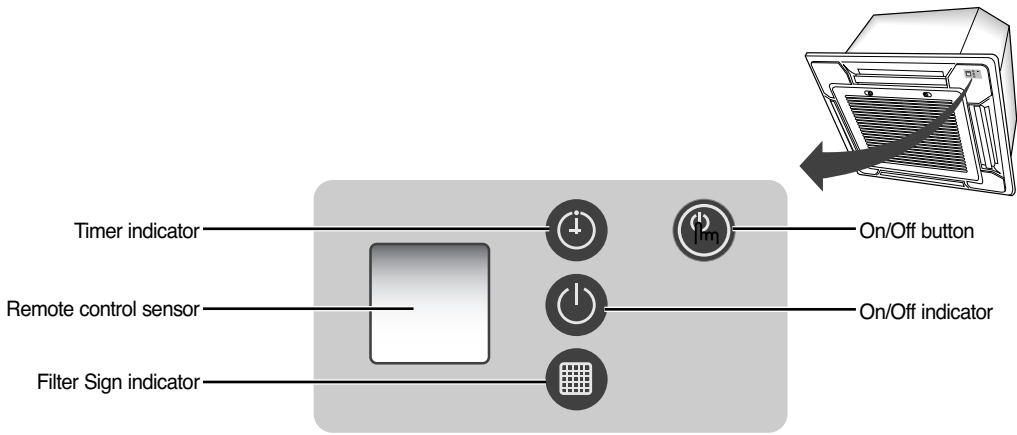

# Getting Start

*You have just purchased a cassette type air conditioner and it has been installed by your installation specialist.*

*Your Owner's Instructions contain much valuable information on using your air conditioner. Please take the time to read them as they will help you take full advantage of the unit's features.*

*The booklet is organized as follows.*

- ◆ *The following figures are shown on pages from 4 to 9 :*
  - *Indoor and outdoor units*
  - *Wired remote controller (buttons and display)*
  - *Wireless remote controller (buttons and display)*
  - *Centralized controller*
  - *The indicators on the unit (For wireless remote controller only)*
  
- ◆ *In the main part of the document, you will find a series of step-by-step procedures for each function available.*

*The illustrations in the step-by-step procedures use three different symbols:*

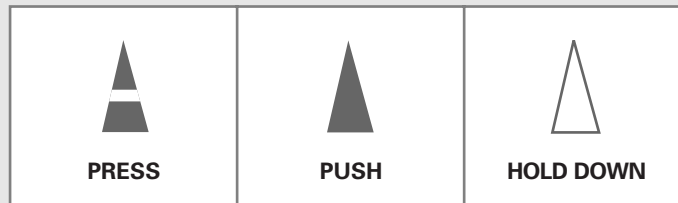

## Inserting the Wireless Remote Controller Batteries

**You must insert or replace the remote controller batteries when :**

- ◆ **You purchase the air conditioner**
- ◆ **The remote controller does not work correctly**

**Note**

- ◆ Use two AAA, LR03 1.5V batteries.
- ◆ Do not use old batteries or different kinds of batteries together.
- ◆ Batteries may be completely discharged after 12 months, even if they have not actually been used.

- 1 Push the battery cover on the rear of the remote controller with your thumb in the direction of the arrow and remove it.
- 2 Insert the two batteries, taking care to respect the polarities :
  - ◆ + on the battery with + on the remote controller.
  - ◆ - on the battery with - on the remote controller.
- 3 Close the cover by sliding it back until it clicks into place.

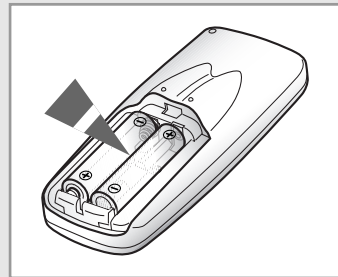
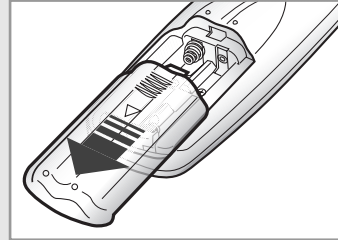

# Using Wired Remote Controller

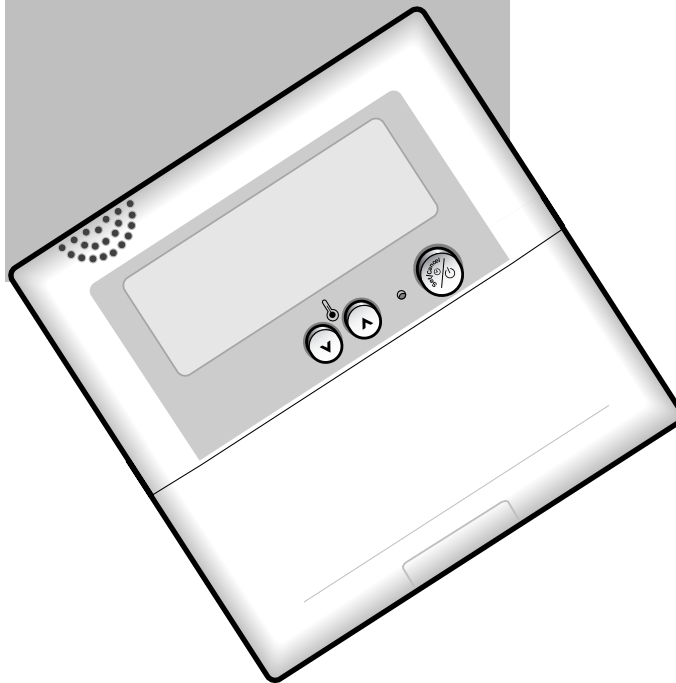

This chapter indicates how to operate and program your air conditioner with the wired remote controller. The wired remote controller is an optional accessory.

## Selecting the Automatic Operating Mode



***In the Automatic mode, the room temperature and the fan speed are controlled automatically.***

- 1 If necessary, press  (ON/OFF) button.

**Result:**

- ◆ The On/Off indicator on the wired remote controller comes on.
- ◆ The air conditioner runs in the mode selected when the unit was last used.

**IMPORTANT** The air conditioner is fitted with a protection mechanism to prevent the unit from being damaged when it is started immediately after being:

- ◆ Plugged in
- ◆ Stopped

It will start up normally after three minutes.

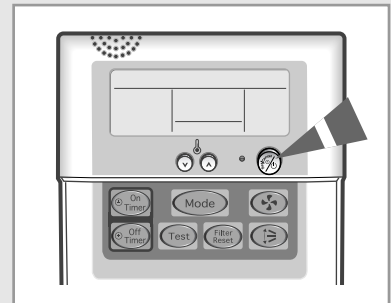

- 2 To select the AUTO mode, press the Mode button until  is displayed at the top of the wired remote controller.

**Result:** ◆ The air conditioner runs in AUTO mode.

**Note** You can change modes at any time.

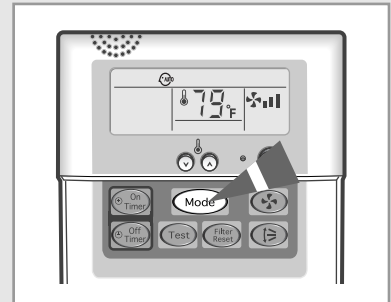

- 3 To adjust the temperature, press the Temperature buttons one or more times until the required temperature is displayed. Possible temperatures are between 65°F and 86°F inclusive.

**Result:**

- ◆ Each time you press Temperature buttons:
  - The temperature is adjusted by 1°F.
- ◆ The air conditioner starts cooling, provided that the room temperature is higher than the selected temperature:
  - The quantity of air is adjusted automatically.

## Cooling Your Room

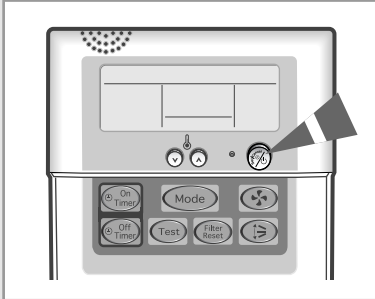

You must select the COOL mode if you wish to adjust the :

- ◆ Cooling temperature
- ◆ Fan speed when cooling

1 If necessary, press (ON/OFF) button.

- Result:**
- ◆ The On/Off indicator on the wired remote controller comes on.
  - ◆ The air conditioner runs in the mode selected when the unit was last used.

**IMPORTANT** The air conditioner is fitted with a protection mechanism to prevent the unit from being damaged when it is started immediately after being:

- ◆ Plugged in
- ◆ Stopped

It will start up normally after three minutes.

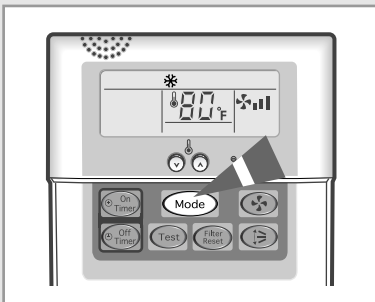

2 To select the COOL mode, press the Mode button until is displayed at the top of the wired remote controller.

- Result:** ◆ The air conditioner runs in COOL mode.

**Note** You can change modes at any time.



3 To adjust the temperature, press the Temperature buttons one or more times until the required temperature is displayed. Possible temperatures are between 65°F and 86°F inclusive.

- Result:**
- ◆ Each time you press Temperature buttons:
    - The temperature is adjusted by 1°F.
  - ◆ The air conditioner starts cooling, provided that the room temperature is higher than the selected temperature ; the fan will, however, operate.

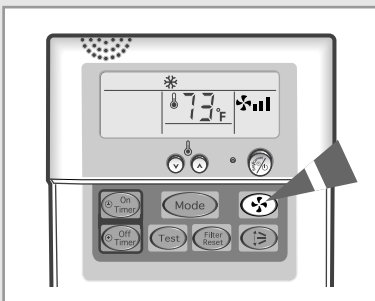

4 Select the fan speed by pressing the Fan button one or more times until the intended value is displayed :

- Automatic (rotated : )
- Low
- Medium
- High

5 To control the direction of the air flow, refer to page 17.

## Removing Excess Humidity



**If the atmosphere in your room is very humid or damp, you can remove excess humidity without lowering the room temperature too much.**

- 1 If necessary, press  (ON/OFF) button.

**Result:**

- ◆ The On/Off indicator on the wired remote controller comes on.
- ◆ The air conditioner runs in the mode selected when the unit was last used.

**IMPORTANT** The air conditioner is fitted with a protection mechanism to prevent the unit from being damaged when it is started immediately after being:

- ◆ Plugged in
- ◆ Stopped

It will start up normally after three minutes.

- 2 To select the DRY mode, press the Mode button until  is displayed at the top of the wired remote controller.

**Result:** ◆ The air conditioner runs in DRY mode.

**Note** You can change modes at any time.

- 3 To adjust the temperature, press the Temperature buttons one or more times until the required temperature is displayed. Possible temperatures are between 65°F and 86°F inclusive.

**Result:**

- ◆ Each time you press Temperature buttons:
  - The temperature is adjusted by 1°F.
- ◆ The air conditioner starts removing the excess humidity. The quantity of air is adjusted automatically.

**Note** In the dry mode, the fan speed is controlled automatically.

- 4 To control the direction of the air flow, refer to page 17.

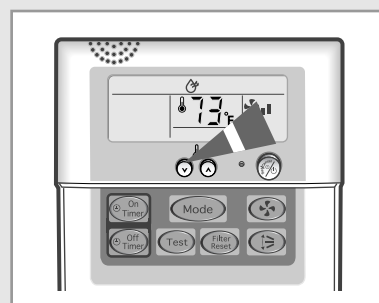
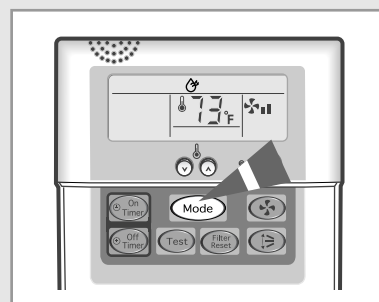
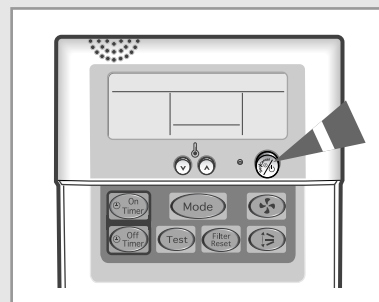

## Airing Your Room

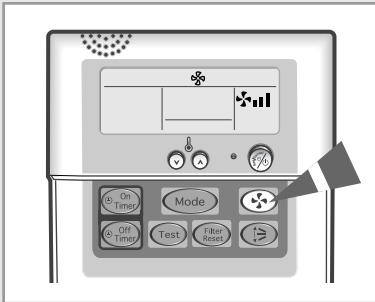
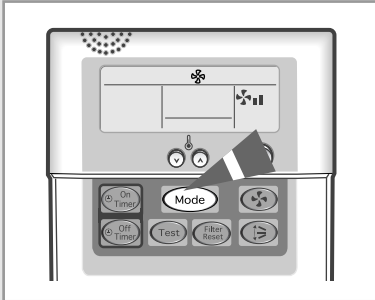

***If the atmosphere in your room is stale, you can air it using the FAN feature.***

- 1 If necessary, press  (ON/OFF) button.



**Result:**

- ◆ The On/Off indicator on the wired remote controller comes on.
- ◆ The air conditioner runs in the mode selected when the unit was last used.

- 2 To select the FAN mode, press the Mode button until  is displayed at the top of the wired remote controller.

**Result:** ◆ The air conditioner runs in FAN mode.

- 3 Select the fan speed by pressing the Fan button one or more times until the intended value is displayed:

	Low
	Medium
	High

- 4 To control the direction of the air flow, refer to page 17.



## Adjusting the Air Flow Direction



*Depending on the position of the indoor unit, you can adjust the position of the air flow blades, thus increasing the efficiency of the air conditioner.*

- 1 Press the Swing button.

**Result:** The blades are moving between up and down.

**IMPORTANT** When the air conditioner is first turned on, the blades are moved.

- 2 To stop the blades, press the Swing button again.  
To set to the required position, press the Swing button again.  
When the blades are in the required position.

**Note** You can also adjust by the hands the blades which are not operated by the Swing button.

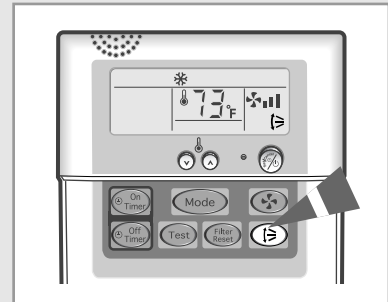

## Setting the On Timer

**The On Timer enables you to switch on the air conditioner automatically after a given period of time. You can set the period of time from 30 minutes to 24 hours.**

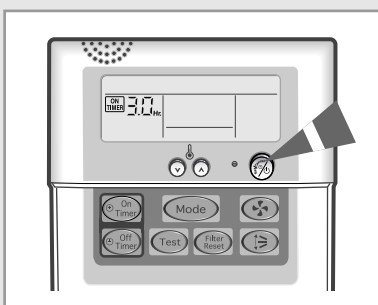
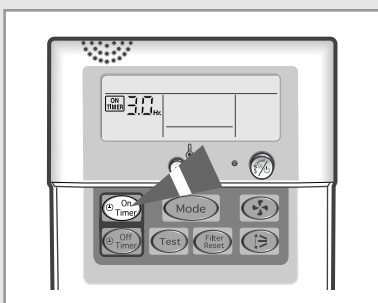

- 1 To set the operating time, press the On Timer button one or more times until the required time is displayed. Possible time is between 0.5 hour and 24 hours inclusive.

**Result:** ◆ Each time you press On Timer button:  
- The time is adjusted by 0.5 hour to 5 hours, by 1 hour from 6 hours to 24 hours.

- 2 Press the  (Set/Cancel) button to complete the setting.

**Result:** ◆ The remaining time is displayed.  
◆ Blinking of the timer indicator stops.  
◆ The selected mode and the temperature disappear on the display after 5 seconds.  
◆ The air conditioner will switch on automatically when the counter displayed on the remote controller reaches the setting time as disappearing the On timer setting.

**Note** You can see or change the setting mode and/or the temperature by pressing the Mode button or the Temperature buttons after setting the On timer.

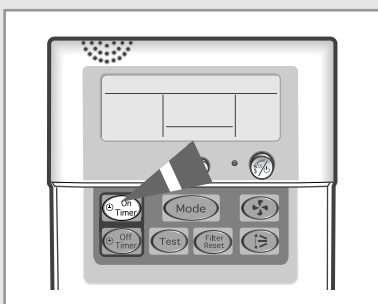

## To Cancel the On Timer

- 1 To cancel the On Timer, press the On Timer button one or more times until the On timer setting disappears.

- 2 Press the  (Set/Cancel) button.

**Note** If you want to turn on the air conditioner before the timer reaches the setting time, press the  (ON/OFF) button.

## Setting the Off Timer

**The Off Timer enables you to switch off the air conditioner automatically after a given period of time. You can set the period of time from 30 minutes to 24 hours.**

- 1 To set the operating time, press the Off Timer button one or more times until the required time is displayed. Possible time is between 0.5 hour and 24 hour inclusive.

**Result:** ◆ Each time you press Off Timer button:  
 - The time is adjusted by 0.5 hour to 5 hours, by 1 hour from 6 hours to 24 hours.

- 2 Press the (Set/Cancel) button to complete the setting.

**Result:** ◆ The remaining time is displayed.  
 ◆ Blinking of the timer indicator stops.  
 ◆ The selected mode and the temperature disappear on the display after 5 seconds.  
 ◆ The air conditioner will switch off automatically when the counter displayed on the remote controller reaches the setting time as disappearing the Off timer setting.

**Example** If you would like to turn the air conditioner on after 2 hours and to operate it for 2 hours:

1. Press the On Timer button until '2.0 Hr' is displayed.
2. Press the (Set/Cancel) button.
3. Press the Off Timer button until '4.0 Hr' is displayed.
4. Press the (Set/Cancel) button.

**Note** You can see or change the setting mode and/or the temperature by pressing the Mode button or the Temperature buttons after setting the Off timer.

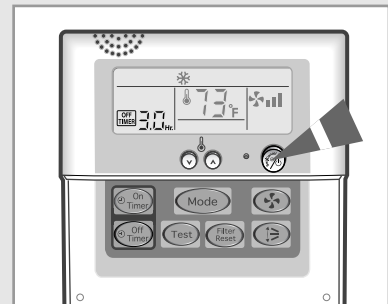
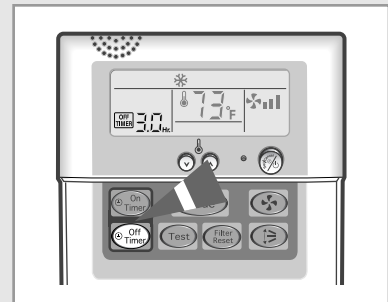

## To Cancel the Off Timer

- 1 To cancel the Off Timer, press the Off Timer button one or more times until the timer setting disappears.

- 2 Press the (Set/Cancel) button.

**Note** If you want to turn off the air conditioner before the timer reaches the setting time, press the (ON/OFF) button.

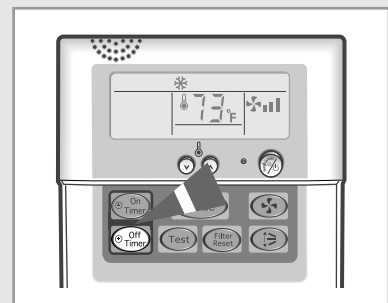

# Using Wireless Remote Controller

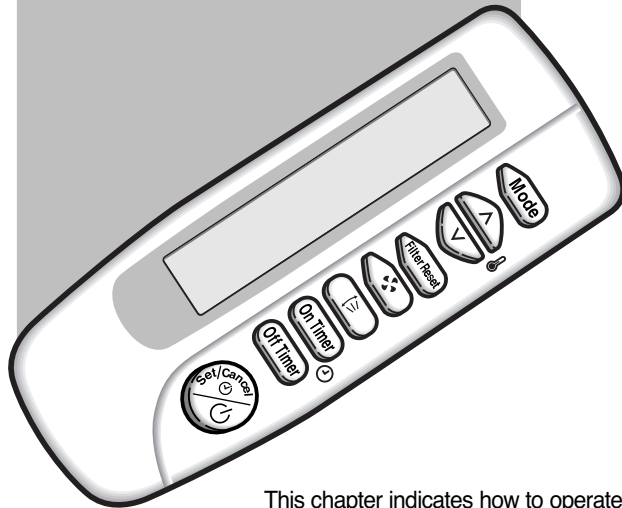

This chapter indicates how to operate and program your air conditioner with the wireless remote controller. The wireless remote controller is an optional accessory.

## Selecting the Automatic Operation Mode



**In the Automatic mode, the room temperature and the fan speed are controlled automatically.**

- 1 If necessary, press  (ON/OFF) button.

**Result:**

- ◆ The On/Off indicator on the unit comes on.
- ◆ The air conditioner runs in the mode selected when the unit was last used.
- ◆ The indoor unit beeps.

**IMPORTANT** The air conditioner is fitted with a protection mechanism to prevent the unit from being damaged when it is started immediately after being:

- ◆ Plugged in
- ◆ Stopped

It will start up normally after three minutes.

- 2 To select the AUTO mode, press the Mode button until  is displayed at the top of the wireless remote controller.

**Result:**

- ◆ The indoor unit beeps.
- ◆ The air conditioner runs in AUTO mode.

**Note** You can change modes at any time.

- 3 To adjust the temperature, press the Temperature buttons one or more times until the required temperature is displayed. Possible temperatures are between 65°F and 86°F inclusive.

**Result:**

- ◆ Each time you press Temperature buttons:
  - The temperature is adjusted by 1°F.
- ◆ The air conditioner starts cooling, provided that the room temperature is higher than the selected temperature:
  - The quantity of air is adjusted automatically.

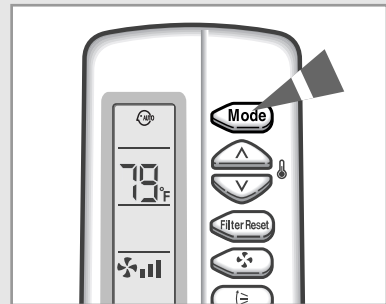
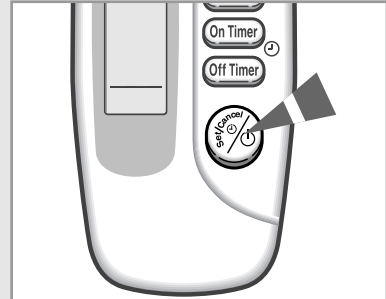

## Cooling Your Room



You must select the **COOL** mode if you wish to adjust the :

- ◆ Cooling temperature
- ◆ Fan speed when cooling

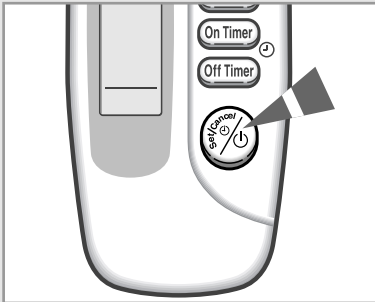

- 1 If necessary, press (ON/OFF) button.

- Result:**
- ◆ The On/Off indicator on the unit comes on.
  - ◆ The air conditioner runs in the mode selected when the unit was last used.
  - ◆ The indoor unit beeps.

**IMPORTANT** The air conditioner is fitted with a protection mechanism to prevent the unit from being damaged when it is started immediately after being:

- ◆ Plugged in
- ◆ Stopped

It will start up normally after three minutes.

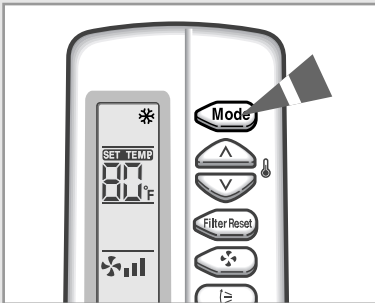

- 2 To select the COOL mode, press the Mode button until is displayed at the top of the wireless remote controller.

- Result:**
- ◆ The indoor unit beeps.
  - ◆ The air conditioner runs in COOL mode.

**Note** You can change modes at any time.

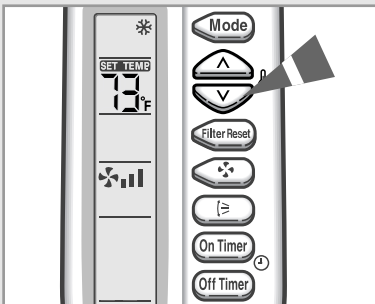

- 3 To adjust the temperature, press the Temperature buttons one or more times until the required temperature is displayed. Possible temperatures are between 65°F and 86°F inclusive.

- Result:**
- ◆ Each time you press Temperature buttons:
    - The temperature is adjusted by 1°F.
    - The indoor unit beeps.
  - ◆ The air conditioner starts cooling, provided that the room temperature is higher than the selected temperature ; the fan will, however, operate.

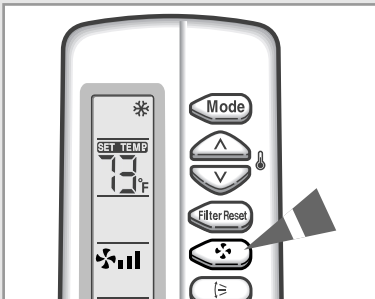

- 4 Select the fan speed by pressing the Fan button one or more times until the intended value is displayed :

- Automatic (rotated : → → )
- Low
- Medium
- High

- 5 To control the direction of the air flow, refer to page 25.



# Removing Excess Humidity

**If the atmosphere in your room is very humid or damp, you can remove excess humidity without lowering the room temperature too much.**

1 If necessary, press (ON/OFF) button.

- Result:**
- ◆ The On/Off indicator on the unit comes on.
  - ◆ The air conditioner runs in the mode selected when the unit was last used.
  - ◆ The indoor unit beeps.

**IMPORTANT** The air conditioner is fitted with a protection mechanism to prevent the unit from being damaged when it is started immediately after being:

- ◆ Plugged in
- ◆ Stopped

It will start up normally after three minutes.

2 To select the DRY mode, press the Mode button until is displayed at the top of the wireless remote controller.

- Result:**
- ◆ The indoor unit beeps.
  - ◆ The air conditioner runs in DRY mode.

**Note** You can change modes at any time.

3 To adjust the temperature, press the Temperature buttons one or more times until the required temperature is displayed. Possible temperatures are between 65°F and 86°F inclusive.

- Result:**
- ◆ Each time you press Temperature buttons:
    - The temperature is adjusted by 1°F.
    - The indoor unit beeps.
  - ◆ The air conditioner starts removing the excess humidity. The quantity of air is adjusted automatically.

**Note** In the dry mode, the fan speed is controlled automatically.

4 To control the direction of the air flow, refer to page 25.

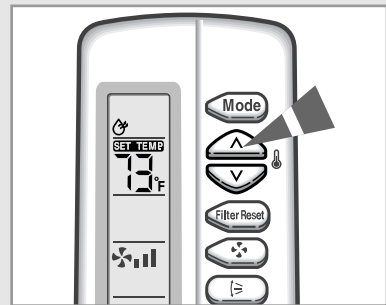
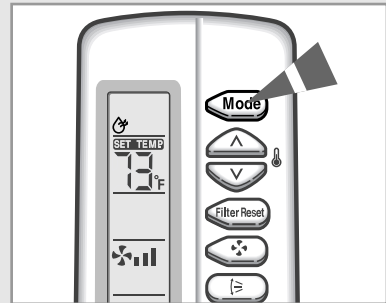
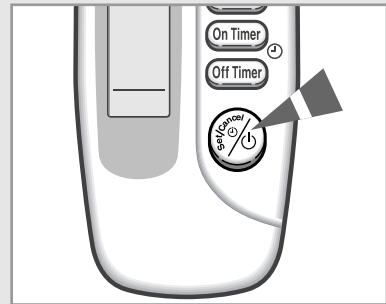

## Airing Your Room

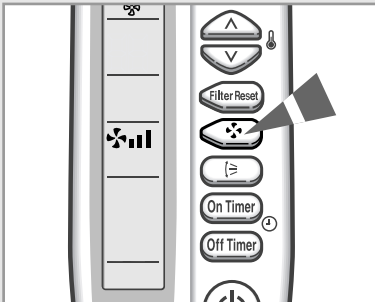
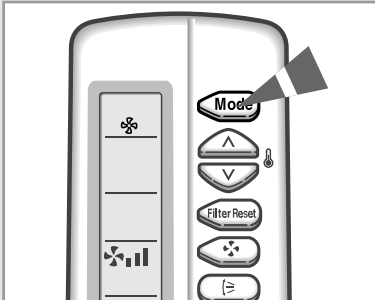

**If the atmosphere in your room is stale, you can air it using the FAN feature.**

- 1 If necessary, press  (ON/OFF) button.

**Result:**

- ◆ The On/Off indicator on the unit comes on.
- ◆ The air conditioner runs in the mode selected when the unit was last used.
- ◆ The indoor unit beeps.



- 2 To select the FAN mode, press the Mode button until  is displayed at the top of the wireless remote controller.

**Result:**

- ◆ The indoor unit beeps.
- ◆ The air conditioner runs in FAN mode.

**Note** You can change modes at any time.

- 3 Select the fan speed by pressing the Fan button one or more times until the intended value is displayed:

 Low  
 Medium  
 High

- 4 To control the direction of the air flow, refer to page 25.



## Adjusting the Air Flow Direction



*Depending on the position of the indoor unit, you can adjust the position of the air flow blades, thus increasing the efficiency of the air conditioner.*

- 1 Press the Swing button.

**Result:**

- ◆ The blades are moving between up and down.
- ◆ The indoor unit beeps.

**IMPORTANT** When the air conditioner is first turned on, the blades are moved.

- 2 To stop the blades, press the Swing button again.  
To set to the required position, press the Swing button again.  
When the blades are in the required position.

**Note** You can also adjust by the hands the blades which are not operated by the swing button.

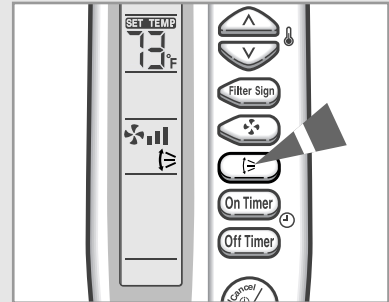

## Setting the On Timer

**The On Timer enables you to switch on the air conditioner automatically after a given period of time. You can set the period of time from 30 minutes to 24 hours.**

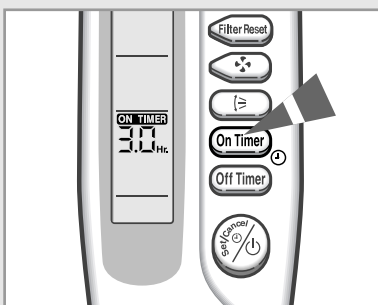

- 1 To set the operating time, press the On Timer button one or more times until the required time is displayed. Possible time is between 0.5 hour and 24 hour inclusive.

**Result:** ♦ Each time you press On Timer button:  
- The time is adjusted by 0.5 hour to 5 hours, by 1 hour from 6 hours to 24 hours.

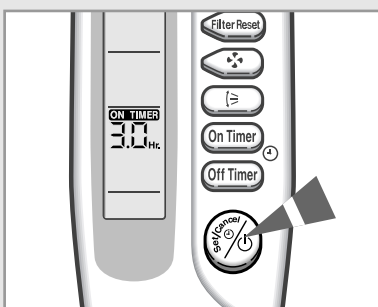

- 2 Press the (Set/Cancel) button to complete the setting.

**Result:** ♦ The remaining time is displayed.  
♦ Blinking of the timer indicator stops.  
♦ The selected mode and the temperature disappear on the display after 5 seconds.  
♦ The air conditioner will switch on automatically when the counter displayed on the remote controller reaches the setting time as disappearing the On timer setting.

**Note** You can see or change the setting mode and/or the temperature by pressing the Mode button or the Temperature buttons after setting the On timer.

## To Cancel the On Timer

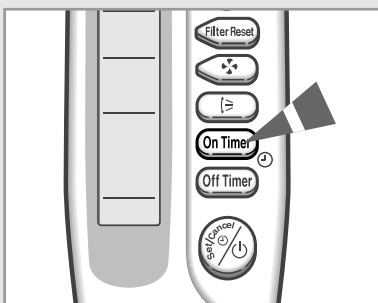

- 1 To cancel the On Timer, press the On Timer button one or more times until the timer setting disappears.

- 2 Press the (Set/Cancel) button.

**Note** If you want to turn on the air conditioner before the timer reaches the setting time, press the (ON/OFF) button.

## Setting the Off Timer

**The Off Timer enables you to switch off the air conditioner automatically after a given period of time. You can set the period of time from 30 minutes to 24 hours.**

- 1 To set the operating time, press the Off Timer button one or more times until the required time is displayed. Possible time is between 0.5 hour and 24 hour inclusive.

**Result:** ◆ Each time you press Off Timer button:  
 - The time is adjusted by 0.5 hour to 5 hours, by 1 hour from 6 hours to 24 hours.

- 2 Press the (Set/Cancel) button to complete the setting.

**Result:** ◆ The remaining time is displayed.  
 ◆ Blinking of the timer indicator stops.  
 ◆ The selected mode and the temperature disappear on the display after 5 seconds.  
 ◆ The air conditioner will switch off automatically when the counter displayed on the remote controller reaches the setting time as disappearing the Off timer setting.

**Example** If you would like to turn the air conditioner on after 2 hours and to operate it for 2 hours:

1. Press the On Timer button until '2.0 Hr' is displayed.
2. Press the (Set/Cancel) button.
3. Press the Off Timer button until '4.0 Hr' is displayed.
4. Press the (Set/Cancel) button.

**Note** You can see or change the setting mode and/or the temperature by pressing the Mode button or the Temperature buttons after setting the Off timer.

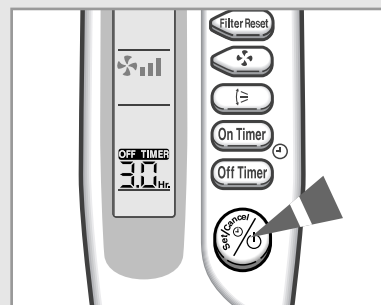
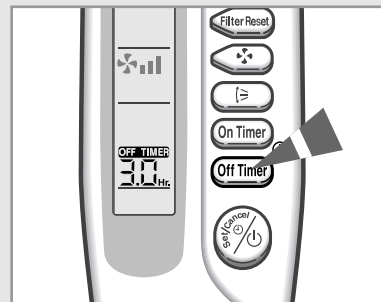

## To Cancel the Off Timer

- 1 To cancel the Off Timer, press the Off Timer button one or more times until the timer setting disappears.

- 2 Press the (Set/Cancel) button.

**Note** If you want to turn off the air conditioner before the timer reaches the setting time, press the (ON/OFF) button.

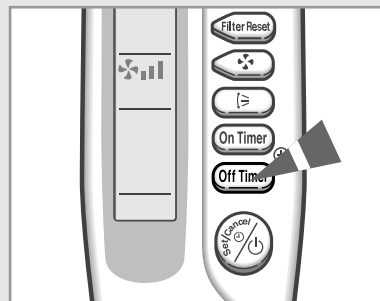





## Using the Centralized Controller

The centralized controller is an optional accessory.

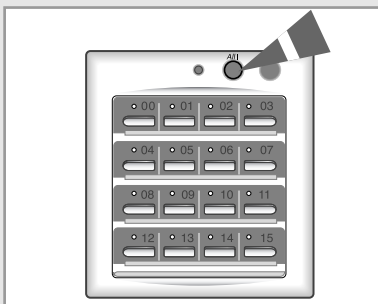
**Up to sixteen air conditioners can be turned on or off by connecting to the centralized controller. However, you cannot adjust the cooling temperature or set the timer with it. If you also have the wired remote controller, **CENTRALIZED CONTROL** is displayed at the top of the remote controller.**



- 1 To turn on the all of air conditioners connected to the centralized controller, press the  (All ON) button.

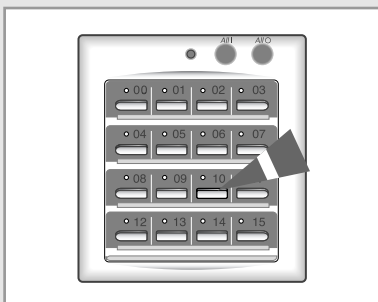

- 2 To turn on/off a specific air conditioner, press the  (ON/OFF) button.  
**Result:** ♦ The On/Off indicator comes on when the air conditioner is operating.

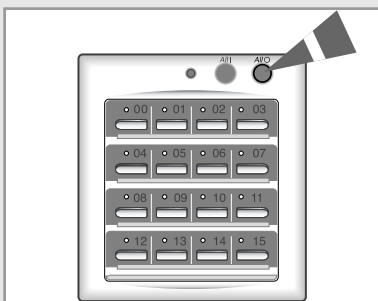

- 3 To turn off the all of air conditioners connected to the centralized controller, press the  (All OFF) button.

## Operating Recommendations

***Here are a few recommendations that you should follow when operating your air conditioner.***

Topic	Recommendation
Power failure	If a power failure occurs while the air conditioner is operating, the unit will be switched off. When the power returns, the air conditioner restarts in the previous operation mode.

## Temperature and Humidity Ranges

***The following table indicates the temperature and humidity ranges, within which the air conditioner can be used.***

If the air conditioner is used at...	Then...
High temperature	The automatic protection feature may be triggered and the air conditioner stopped.
Low temperature	A water leakage or some other malfunction may happen if the heat exchanger freezes.
High humidity levels	Water may condense on and drip from the surface of the indoor unit if it is used for a long periods.

Mode	Outdoor Temperature	Indoor Temperature	Indoor Humidity
Cooling	23°F to 109°F approx.	70°F to 90°F approx.	80% or less
Drying	70°F to 109°F approx.	70°F to 90°F approx.	-

\* ***If the cooling operation is used at over 91°F(indoor temperature) then, does not a full capacity.***

## Cleaning Your Air Conditioner

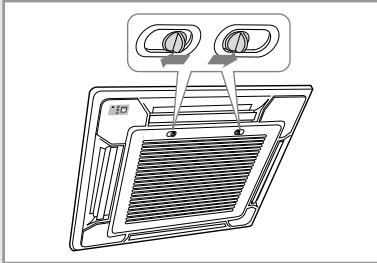

**To get the best possible use out of your air conditioner, you must clean it regularly to remove the dust that accumulates on the air filter.**

**IMPORTANT** Before cleaning your air conditioner, ensure that you have switched off the electric circuit breaker used for the unit.

1 Open the front grille by pushing the tabs on the grille.

**IMPORTANT** You must give attention when disassembling the front grille and must check the safety clips have been installed. If you do not check them, the front grille will drop suddenly and you will be hurt.

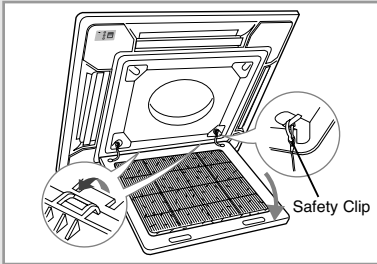

2 Remove the front grille.

2-1 Remove the safety clips.

2-2 Open the front grille about 45° and pull it forward.

3 Pull out the air filter.

4 Remove all dust on air filter with a vacuum cleaner or a brush. In case of serious dust accumulation, put the air filter in warm detergent water and shake it vertically.

**Note** When you have installed the Bio-Pure filter, do not allow any liquids to contact the filter. It may lose its properties.

5 Dry the air filter.

6 When you have finished, insert the filter into the front grille.

7 Clean the unit with a vacuum cleaner or a brush once a month.

8 Reinstall the front grille and the safety clips.

**Note** You can use all 4 points of the indoor unit for installing the front grille and the safety clips depending on your requirement.

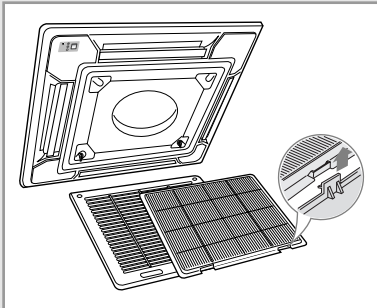

**Note** After cleaning the air conditioner, press the Filter Reset button.

Wired Remote Controller

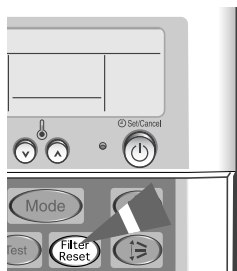

Wireless Remote Controller

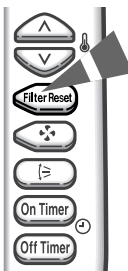

## Bio-Pure Filter Installation (Optional)

*The air conditioner can be fitted with a Bio-Pure filter to remove minute dust particles. The service life of the filter is approximately three months depending on the time during which the air conditioner is used.*

- 1 Remove the vinyl packing from the filter.

**Note** Do not remove the packing from a bio-pure filter until you wish to use the filter, as it will lose its properties.

- 2 Open the front grille by pulling the tabs on the grille.

- 3 Remove the front grille.
  - 3-1 Remove the safety clips.
  - 3-2 Open the front grille about 45° and pull it forward.

- 4 Pull out the air filter.

- 5 Locate the bio-pure filter on the center of air filter.

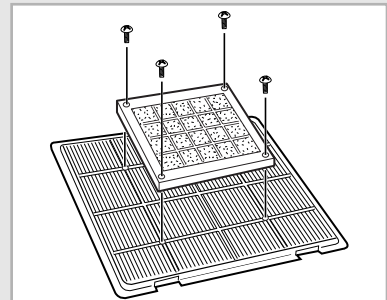

- 6 Secure the bio-pure filter with four screws.

- 7 Reinstall the air filter, the front grille and the safety clips.



## Solving Common Problems

***Before contacting the after-sales service, perform the following simple checks. They may save your time and expense of an unnecessary call.***

Problem	Explanation/Solution
The air conditioner does not operate at all	<ul style="list-style-type: none"> <li>◆ Check that the breaker used for the air conditioner is switched on.</li> </ul>
<b>Wired Remote Controller</b>	
The air conditioner does not operate with the remote controller	<ul style="list-style-type: none"> <li>◆  is displayed on the wired remote controller. In this case, turn the air conditioner off and contact your dealer.</li> </ul>
<b>Wired Remote Controller</b>	
When turning on/off the air conditioner, it is not turned on/off immediately.	<ul style="list-style-type: none"> <li>◆ In case of using the wired remote controller for a group, the air conditioners connected to the remote controller are turned on/off in order. Thus, it takes some time(up to 32 seconds).</li> </ul>
<b>Wireless Remote Controller</b>	
The air conditioner does not operate with the remote controller	<ul style="list-style-type: none"> <li>◆ Check that there are no obstacles between you and the remote control sensor.</li> <li>◆ Check the wireless remote controller batteries (Refer to page 11).</li> <li>◆ Check that you are close enough to the remote control sensor. (seven metres/yards/23ft or less).</li> </ul>
<b>Wireless Remote Controller</b>	
No beep is heard when you press  (ON/OFF) on the remote controller	<ul style="list-style-type: none"> <li>◆ Check that you are pointing the remote controller at the remote control sensor of the receiver &amp; display unit.</li> <li>◆ Replace the remote controller batteries if necessary.</li> <li>◆ If there is a strong light around the air conditioner, a three-wavelength light, a neon sign, etc., for example, the air conditioner may not be operated with a remote controller. If this happens, use the remote controller close by the remote control sensor.</li> </ul>
The air conditioner does not cool	<ul style="list-style-type: none"> <li>◆ Check that the correct operating mode has been selected.</li> <li>◆ The room temperature may be too low or too high.</li> <li>◆ Dust may be blocking the air filter guard; refer to page 30 for cleaning instructions.</li> <li>◆ Check that there is no obstacle in front of the outdoor unit.</li> </ul>



# Specifications

MODEL			ACC2400C	ACC2800C
Performance Ratings	Capacity Cooling	Btu/h	23000	28000
	SEER		10.0	10.0
	Moisture Removal	Pts/h	5	6
	Air FLOW(Cooling, HIGH)	CFM	565	600
	Sound Rating-(In/Out)	dB	46/58	49/61
Electrical Data	Power source	∅, V, Hz	1∅, 208-230V~, 60Hz	1∅, 208-230V~, 60Hz
	Min.Ampacity	A	12.0	13.0
	Cooling Watts	W	2400	2800
Refrigeration Lines	Connections		Flare	Flare
	Liquid Line O. D.	in	1/4	1/4
	Suction Line O.D.	in	5/8	5/8
	Factory Pre-charge	ft	16	16
	Max. Line length	ft	100	100
	Max. Height Difference	ft	50	50
Dimensions & Weight	<b>INDOOR UNIT</b>		ACC2400C	ACC2800C
	W X H X D	in	33 <sup>1</sup> / <sub>16</sub> x 9 <sup>1</sup> / <sub>16</sub> x 33 <sup>1</sup> / <sub>16</sub>	33 <sup>1</sup> / <sub>16</sub> x 9 <sup>1</sup> / <sub>16</sub> x 33 <sup>1</sup> / <sub>16</sub>
	Net Weight	lbs	64	68
	<b>OUTDOOR UNIT</b>		UCC2400C	UCC2800C
	W X H X D	in	34 <sup>5</sup> / <sub>8</sub> x 25 <sup>1</sup> / <sub>8</sub> x 12 <sup>3</sup> / <sub>16</sub>	34 <sup>5</sup> / <sub>8</sub> x 31 <sup>1</sup> / <sub>8</sub> x 12 <sup>3</sup> / <sub>16</sub>
	Net Weight	lbs	145	168

\* Standard rating conditions Cooling

	Indoor		Outdoor	
	DB	WB	DB	WB
°F	80	67	95	75
°C	26.7	19.4	35.0	23.9

# INSTALLATION MANUAL

## Indoor Unit Dimensions

Unit : mm(inch)

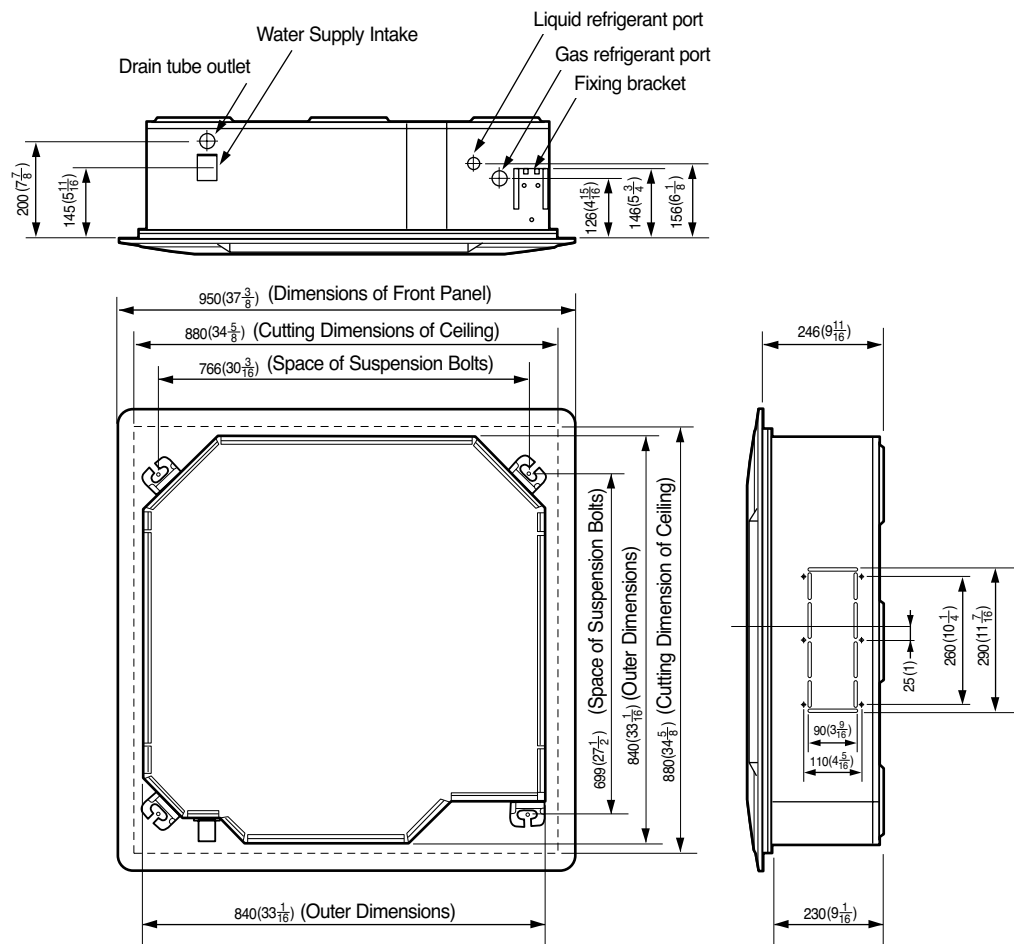

# Contents

---

◆	<b>PREPARING THE INSTALLATION</b>	
■	Deciding on Where to Install the Air Conditioner .....	.36
■	Air Conditioner and Accessories .....	.38
◆	<b>INSTALLING THE INDOOR UNIT</b>	
■	Indoor Unit Installation .....	.39
■	Purging the Unit .....	.40
■	Connecting the Connection Cord .....	.40
■	Drain Hose Installation .....	.42
■	Connecting the Indoor Unit Assembly Piping .....	.44
■	Cutting/Flaring the Pipes .....	.45
◆	<b>INSTALLING THE OUTDOOR UNIT</b>	
■	Connecting the Cables to the Outdoor Unit .....	.46
■	Checking Correct Grounding .....	.47
■	Fixing the Unit in Position .....	.48
◆	<b>COMPLETING THE INSTALLATION</b>	
■	Connecting Up and Removing Air in the Circuit .....	.49
■	Performing Leak Tests .....	.50
■	Insulation .....	.51
■	Installing the Front Panel .....	.52
◆	<b>INSTALLING THE OPTIONAL ACCESSORIES</b>	
■	Setting up Option Switches .....	.53
■	Wired remote controller Installation (Optional) .....	.57
■	Centralized controller Installation (Optional) .....	.58
■	Receiver & display unit Installation (Optional) .....	.60
■	Bio-Pure Filter Installation (Optional) .....	.61
◆	<b>OTHERS</b>	
■	Controlling a Group .....	.62
■	Checking and Testing Operations .....	.64
■	Troubleshooting .....	.66
■	Explaining Operations to the Owner .....	.68

## Deciding on Where to Install the Air Conditioner

***When deciding on the location of the air conditioner with the owner, the following restrictions must be taken into account.***

### ***General***

Do NOT install the air conditioner in a location where it will come into contact with the following elements:

- ◆ Combustible gases
- ◆ Saline air
- ◆ Machine oil
- ◆ Sulphide gas
- ◆ Special environmental conditions

If you must install the unit in such conditions, first consult your dealer.

### ***Indoor Unit***

- ◆ There must be no obstacles near the air inlet and outlet.
- ◆ Choose a space of ceiling that enables the pipes and cables to be easily connected to the outdoor unit and the recommended length of 5m/16ft 5in to be respected ("L" m/ft maximum—"L" indicated in the diagram on the page opposite). Proper drain hose passage should also be considered.
- ◆ Install the indoor unit on a ceiling that can support its weight.
- ◆ Maintain sufficient clearance around the indoor unit, as indicated in the diagram on the page opposite.
- ◆ Make sure that the water dripping from the drain hose runs away correctly and safely.

### ***Outdoor Unit***

- ◆ The outdoor unit must NEVER be placed on its side or upside down, as the compressor lubrication oil will run into the cooling circuit and seriously damage the unit.
- ◆ Choose a location that is dry and sunny, but not exposed to direct sunlight or strong winds.
- ◆ Do not block any passageways or thoroughfares.
- ◆ Choose a location where the noise of the air conditioner when running and the discharged air do not disturb any neighbours.
- ◆ Choose a position that enables the pipes and cables to be easily connected to the indoor unit. Recommended length between indoor and outdoor unit is 5m/16ft 5in ("L" m/ft maximum).
- ◆ Install the outdoor unit on a flat, stable surface that can support its weight and does not generate any unnecessary noise and vibration.
- ◆ Position the outdoor unit so that the air flow is directed towards the open area.
- ◆ Maintain sufficient clearance around the outdoor unit, as indicated in the diagram on the page opposite.
- ◆ If the outdoor unit is installed at a height, ensure that its base is firmly fixed in position; the maximum height difference between indoor and outdoor unit is "H" m/ft ("H" indicated in the diagram on the page opposite.).
- ◆ Make sure that the water dripping from the drain hose runs away correctly and safely.

### ***CAUTION***

- ◆ ***You have just purchased a cassette-type air conditioner and it has to be installed by your installation specialist.***
- ◆ ***This device must be installed according to the national electrical rules.***



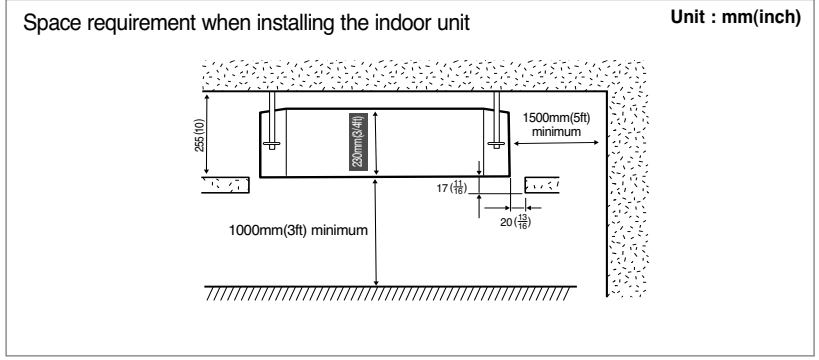
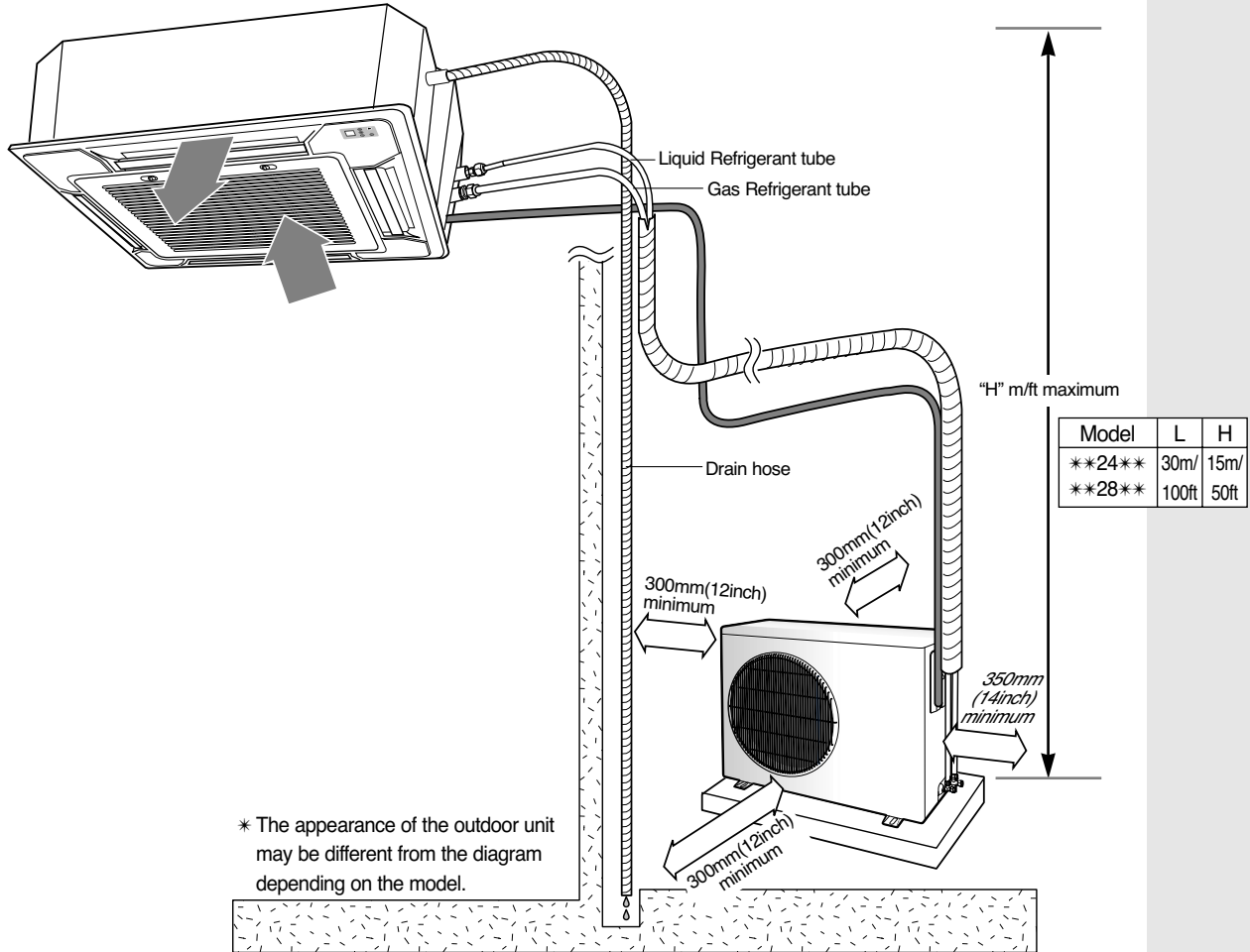









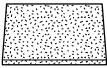

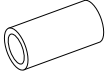
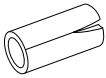
Respect the clearances and maximum lengths indicated in the diagram below when installing the unit.





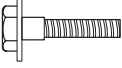













## Air Conditioner and Accessories

The following accessories are supplied with the air conditioner. The quantities are indicated in parentheses.

### Basic Accessories

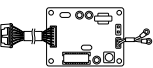
Owner's Instructions & Installation Manual (1) 	Pattern Sheet(1) 	Insulation Cover Drain(1) 	Insulation Cover Pipe(2) 	Insulation Cover Band(1) 	Insulation Pipe 5/8"(1) 
Insulation Drain Pipe(1) 	Cable-Tie(5) 	Flexible Hose(1) 	TH M4 X 12 Tapped Screw(4) 	Pad Stopper(1) 	Insulation Drain Sub (1) 
Bolt(4) <Front Panel> 	Flare Nuts 1/4 (1) 	Flare Nuts 5/8 (1) 	Rubber Leg (4) 		

### Optional Accessories

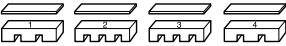
Wired Remote Controller(1) 	Cable-Tie(2) 	Cable Clamp(5) 	TH M4 X 16 Tapped Screw(7) 	
Wireless Remote Controller(1) 	Battery(2) 	FH M4 X 16 Tapped Screw(2) 	Remote Controller Holder(1) 	Receiver & Display Unit(1) 
Centralized Controller(1) 	Cable-Tie(2) 	Cable Clamp(5) 	TH M4 X 16 Tapped Screw(7) 	
Transmitter(1) 	Spacer Support(4) 	Cable-Tie(2) 		
Bio-Pure Filter(1) 	TH M4 X 10 Tapped Screw(4) 	Air blocking Kit(1) 		

**Note** ◆ Refrigeration pipes and their insulating materials, power cables are not supplied.

# Indoor Unit Installation

- 1 Place the pattern sheet on the ceiling at the spot where you want to install the indoor unit.

**Note** ◆ Since the diagram is made of paper, it may shrink or stretch slightly due to temperature or humidity. For this reason, before drilling the holes maintain the correct dimensions between the markings; refer to page 34.

- 2 Insert bolt anchors, use existing ceiling supports or construct a suitable support as shown in figure.

- 3 Install the suspension bolts depending on the ceiling type.

**IMPORTANT** Ensure that the ceiling is strong enough to support the weight of the indoor unit. Before hanging the unit, test the strength of each attached suspension bolt.

- 4 Screw eight nuts to the suspension bolts making space for hanging the indoor unit.

**IMPORTANT** You must install the suspension bolts more than four when installing the indoor unit.

- 5 Hang the indoor unit to the suspension bolts between two nuts.

**Note** ◆ Tubing must be laid and connected inside the ceiling when suspending the unit. If the ceiling is already constructed, lay the tubing into position for connection to the unit before placing the unit inside the ceiling.

- 6 Screw the nuts to suspend the unit. Cut a pad stopper and place it on the bracket at this time.

- 7 Adjust the unit to the appropriate position considering the installation area for the front panel.

- 7-1 Place the pattern sheet on the indoor unit.
- 7-2 Adjust a space between the ceiling and the indoor unit by using the gauge of dimensions.
- 7-3 Fix the indoor unit securely after adjusting level of the unit by using a leveler.
- 7-4 Remove the pattern sheet, connect the other cables and install the front panel.

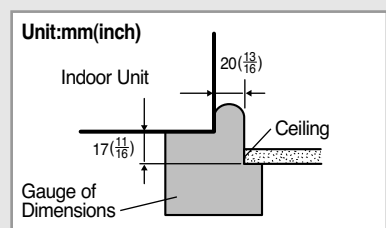
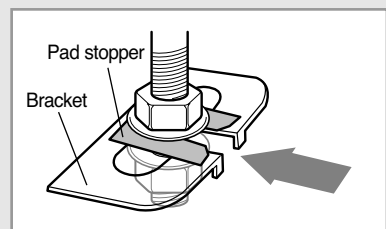
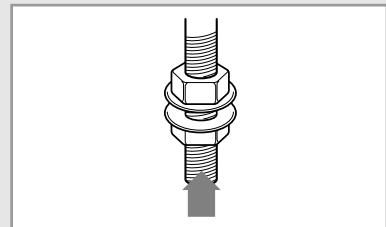
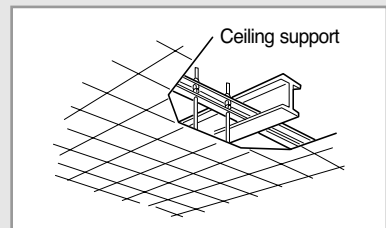
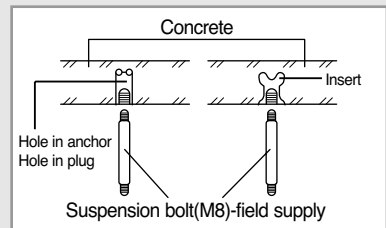
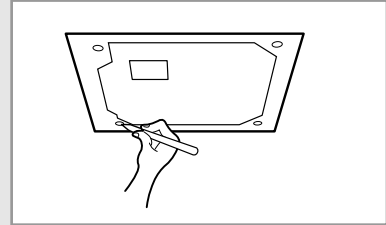

## Purging the Unit

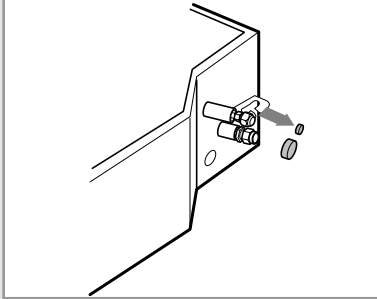

***On delivery, the indoor unit is loaded with an inert nitrogen gas. All this gas must therefore be purged before connecting the assembly piping. To purge the inert gas, proceed as follows.***

Unscrew the caps at the end of each pipe.

**Result:** All inert gas escapes from the indoor unit.

**Note** ◆ To prevent dirt or foreign objects from getting into the pipes during installation, do NOT remove the caps completely until you are ready to connect the piping.

## Connecting the Connection Cord

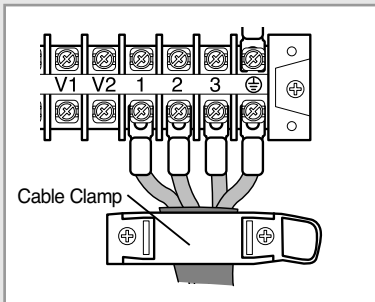

***The indoor unit is powered from the outdoor unit via the connection cord.***

- 1 Remove the screws on the electrical component box and remove the cover plates.
- 2 Route the connection cord through the conduit hole of side of the indoor unit and connect the cable to terminals as shown in page 41.
- 3 Route the other end of the cable to the outdoor unit through the ceiling & the hole on the wall.
- 4 Reassemble the electrical component box cover, carefully tightening the screws.
- 5 For further details on how to plug the other end of the connection cord into the outdoor unit, refer to page 46.



## Wiring Diagram

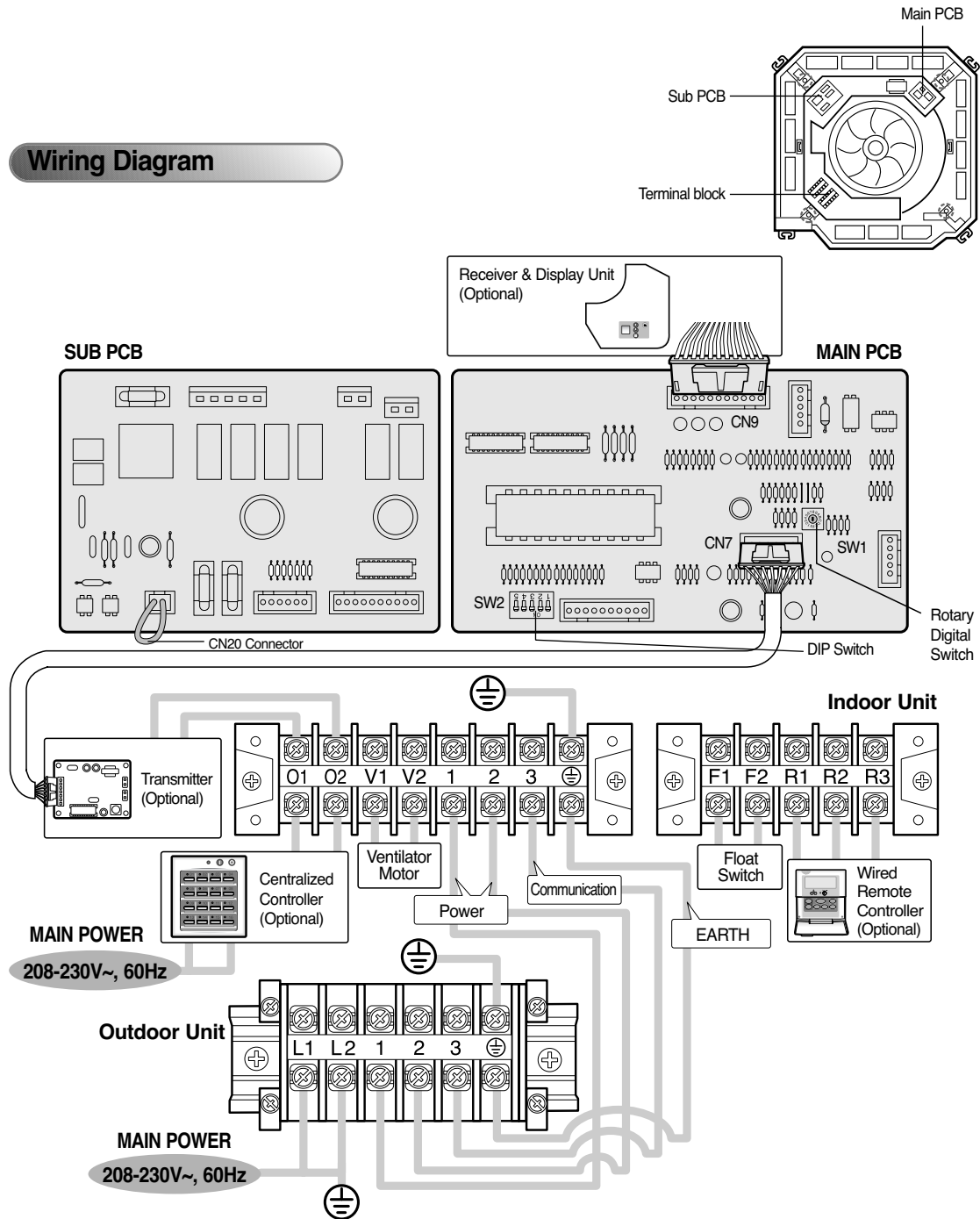

## Cable Specifications

The following electrical characteristics must be respected.

MODEL	ACC2400C	ACC2800C	Note
Power	1Ø - 208-230V~, 60Hz		The power cables are not supplied with the air conditioner. The user should purchase them separately.
Sub switch	25A	30A	
Fuse	25A	30A	
Min. size of electric Wires from/to the indoor/outdoor unit	H07RN-F, 4G, 1.0mm <sup>2</sup>		
Size of electric input wires	20m(6 <sup>9</sup> / <sub>16</sub> ft) or less	H07RN-F, 3G, 2.5mm <sup>2</sup>	
	50m(16 <sup>3</sup> / <sub>8</sub> ft) or less	H07RN-F, 3G, 4.0mm <sup>2</sup>	

## Drain Hose Installation

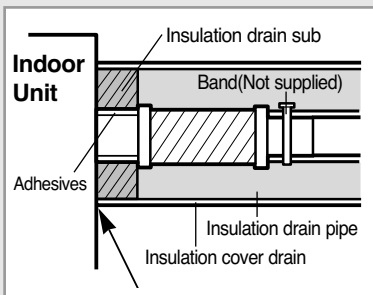
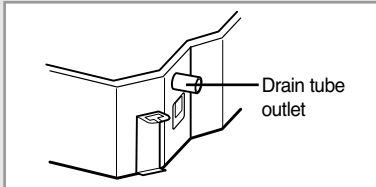

### CAUTION

**Must fit tightly against body without any gap.**

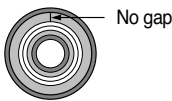

**Care must be taken when installing the drain hose for the indoor unit to ensure that any condensate water is correctly drained outside.**

- 1 Insert the flexible hose to the drain tube outlet, if necessary.

**Note** ♦ Attach the drain hose to the drain tube outlet with the adhesives to prevent water leaks, then secure the hose with a band etc..(The band is not supplied with the air conditioner.)

- 2 Install the drain hose so that its length can be as short as possible. Internal diameter of the drain hose should be the same or slightly bigger than the external diameter.

♦ **Inner diameter of the drain hose**

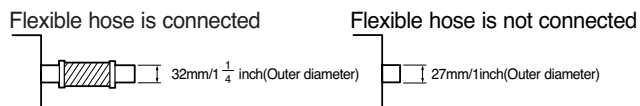

**Note** ♦ Give a slightly slant to the drain hose for proper drainage of condensate.  
♦ Secure the drain hose with the band joint and the cable-tie not to be separated from the unit.

- 3 Wrap the drain hose with the insulation drain as shown in figure and secure it.

**Note** ♦ When connecting the drain hose without the flexible hose, you should attach it to the drain tube outlet with adhesives and tapes to prevent water leaks.

### CAUTION

**Check that the indoor unit is level with the ceiling by using the leveler.**

Do not install air bleeding tubes, as this may cause water to spray from the drain tube outlet.

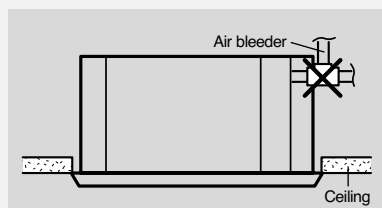

Do not give the hose and upward gradient after the connection port. This will cause water to flow backwards when the unit is stopped, resulting in water leaks.

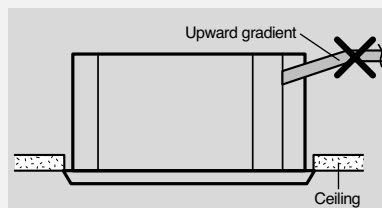

If it is necessary to increase the height of the drain hose somewhat, the portion directly after 30cm/1ft. If it is raised higher than 50cm/1 5/8 ft, there can be water leaks.

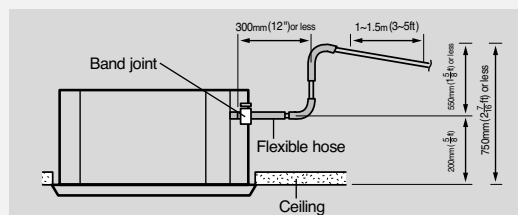

Do not apply force to the piping on the unit side when connecting the drain hose. The hose should not be allowed to hang loose from its connection to the unit. Fasten the hose to a wall, frame or other support as close to the unit as possible.

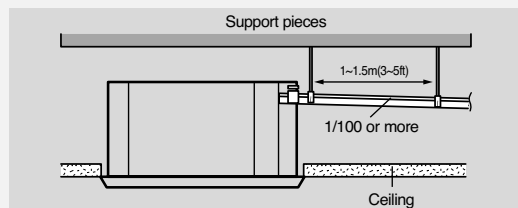

### Testing the drainage

**You should test the drainage after completing the installation.  
Prepare a little water about 2.0 liter.**

- 1 Remove two screws on the cover drain pump and pull out the cover.

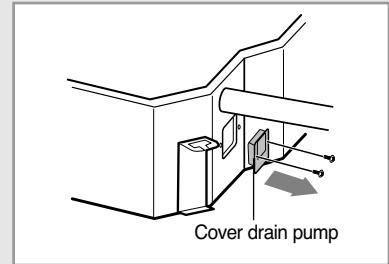

- 2 Pour water into the indoor unit as shown in figure.

**Note** ◆ If you do not pour water inside the water supply intake, water may spill from the indoor unit.

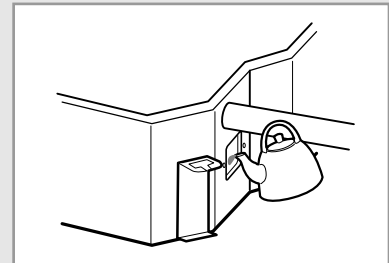

- 3 Confirm that the water flows out through the drain hose.

**Note** ◆ You can check the drainage only when the air conditioner is turned on.

- 4 Reassemble the cover drain pump and the screws.

## Connecting the Indoor Unit Assembly Piping

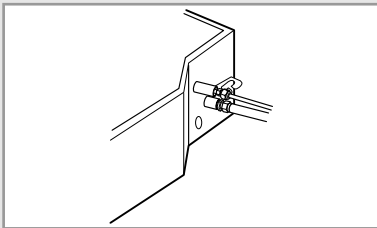
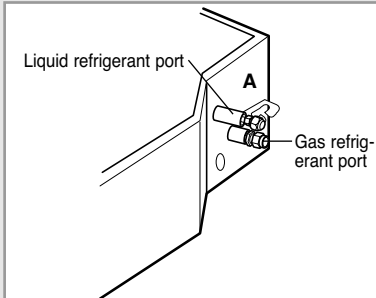

a. When the indoor unit is above the outdoor unit

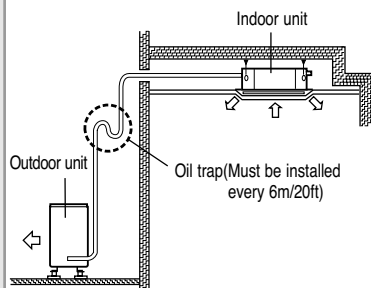

b. When the outdoor unit is above the indoor unit

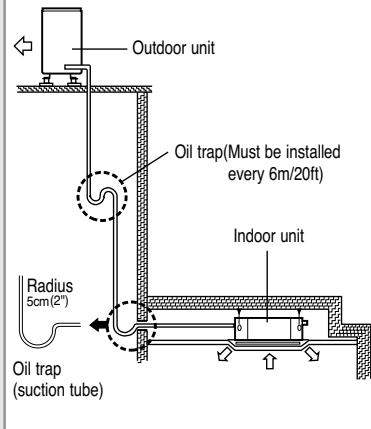

### There are two refrigerant pipes of differing diameters:

- ◆ A smaller one(6.35mm, 1/4") for the liquid refrigerant
- ◆ A larger one(15.88mm, 5/8") for the gas refrigerant
- ◆ The thickness of tube should not less than 1.0mm(1/16").
- ◆ The inside of copper tube must be clean & has no dust.

**The connection procedure for the refrigerant pipes varies according to the exit position of the pipes from the indoor unit, as seen when facing the indoor in the "A" side.**

- ◆ Liquid refrigerant port
- ◆ Gas refrigerant port

- 1 Remove the protection caps on the pipes and connect the assembly pipes to each pipe, tightening the nuts, first manually and then with a wrench, a spanner applying the following torque.

Outer Diameter	Torque (kgf·cm)
6.35 mm (1/4")	160(11 $\frac{3}{5}$ ft·lb)
15.88 mm (5/8")	400(29 ft·lb)

**Note** ◆ If the pipes must be shortened refer to page 45.

- 2 Must use insulator which is thick enough to cover the refrigerant tube to protect the condensate water on the outside of pipe falling onto the floor and the efficiency of the unit will be better.

- 3 Cut off any excess foam insulation.

- 4 Be sure that there must be no crack or wave on the bended area.

- 5 It would be necessary to double the insulation thickness(10mm/ $\frac{3}{8}$ " or more) to prevent condensation even on the insulator when if the installed area is warm and humid.

- 6 Shape an oil trap as shown in figure. The oil trap must be formed every level difference of 6m(20ft).

- 7 For further details on connecting up to the outdoor unit and purging the refrigerant circuit, refer to page 49.

**Note** ◆ The pipes will be insulated and fixed permanently into position once the whole installation has been tested for gas leaks; refer to page 53 for further details.

# Cutting/Flaring the Pipes

**Connect the pipe within 30m(100ft) and cutting pieces will not be gone into the pipe as being clean to pipe section.**

- 1 Make sure that you have the required tools available (pipe cutter, reamer, flaring tool and pipe holder).
- 2 If you wish to shorten the pipes, cut it with a pipe cutter, taking care to ensure that the cut edge remains at a 90° angle with the side of the pipe. Refer to the illustrations below for examples of edges cut correctly and incorrectly.

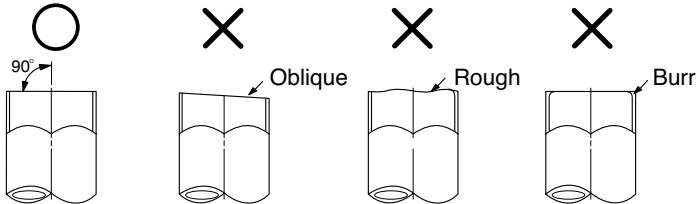

- 3 To prevent any gas from leaking out, remove all burrs at the cut edge of the pipe, using a reamer.

- 4 Slide a flare nut on to the pipe and modify the flare.

Outer Diameter(D)	Depth (A)
6.35 mm (1/4")	1.3 mm(5/100")
15.88 mm (5/8")	2.2 mm(9/100")

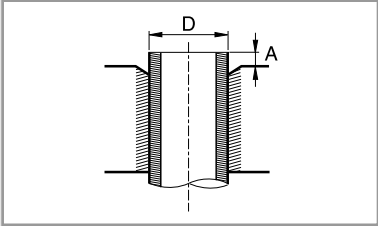
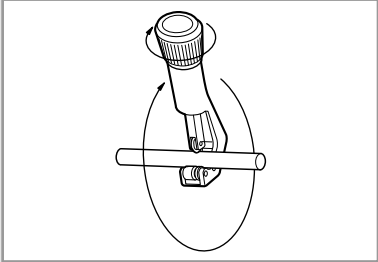

- 5 Check that the flaring is correct, referring to the illustrations below for examples of incorrect flaring.

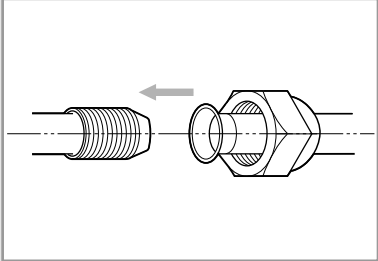
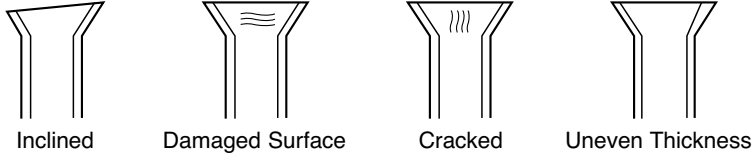

- 6 Align the pipes and tighten the flare nuts first manually and then with a wrench, applying the following torque.

Outer Diameter	Torque(kgf·cm)
6.35 mm (1/4")	160(11 <sup>3</sup> / <sub>5</sub> ft·lb)
15.88 mm (5/8")	400(29 ft·lb)

- 7 For further details on how to connect up to the outdoor unit and purge the circuit, refer to page 49.

**CAUTION**  
**◆ In case of welding the pipe, you must weld with nitrogen gas blowing.**

## Connecting the Cables to the Outdoor Unit

### **Two electric cables must be connected to the outdoor unit.**

- ◆ The connection cord connecting the indoor unit to the outdoor unit
- ◆ The power cable connecting the auxiliary circuit breaker to the outdoor unit

- 1 Remove the terminal board cover on the side of the outdoor unit.
- 2 Connect the connection cord(1, 2, 3, ⊕) and power cable(L1, L2) to terminals through the conduit hole as shown in the diagram.
- 3 Connect the power cable to the auxiliary circuit breaker.  
An all pole disconnection from the power supply must be incorporated in the fixed wiring( $\geq 3\text{mm}/\frac{1}{8}''$ ).
- 4 Replace the terminal board cover, carefully tightening the screw.

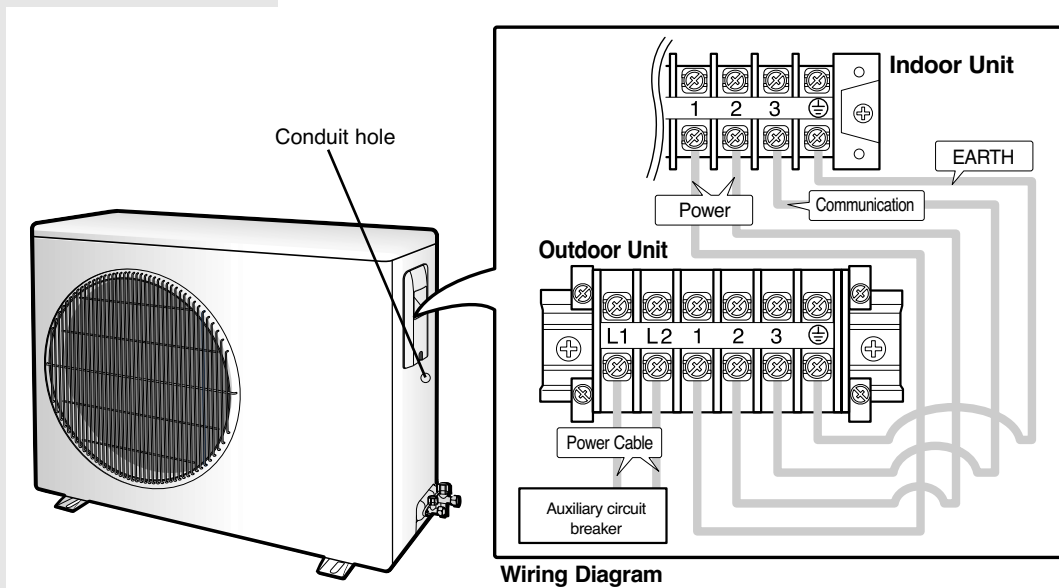

### **CAUTION**

- ◆ **Keep the power cable and the connection cord in a steel pipe to protect them against liquids, outside impacts and so on.**

## Checking Correct Grounding

**If the power distribution circuit does not have an earth or the ground does not comply with specifications, a grounding electrode must be installed. The corresponding accessories are NOT supplied with the air conditioner.**

1 Select a grounding electrode that complies with the specifications given in the illustration.

2 Determine a suitable location for the grounding electrode:

- ◆ In damp hard soil rather than loose sandy or gravel soil that has a higher grounding resistance
- ◆ Away from underground structures or facilities, such as gas pipes, water pipes, telephone lines and underground cables
- ◆ At least two metres away from a lightning conductor grounding electrode and its cable

**Note** ◆ The grounding wire for the telephone line cannot be used to ground the air conditioner.

3 Finish wrapping insulating tape around the rest of the pipes leading to the outdoor unit.

4 Install a green/yellow coloured grounding wire ( $\text{Ø}1.6 \text{ mm}/\frac{1}{16}''$ , section  $2 \text{ mm}^2/\frac{3}{1000} \text{ in}^2$  or greater):

- ◆ If the grounding wire is too short, connect an extension lead, in a mechanical way and wrapping it with insulating tape (do not bury the connection)
- ◆ Secure the grounding wire in position with staples

**Note** ◆ If the grounding electrode is installed in an area of heavy traffic, its wire must be connected securely.

5 Carefully check the installation, by measuring the grounding resistance with a ground resistance tester. If the resistance is above required level, drive the electrode deeper into the ground or increase the number of grounding electrodes.

6 Connect the grounding wire to the electrical component box inside of the outdoor unit.

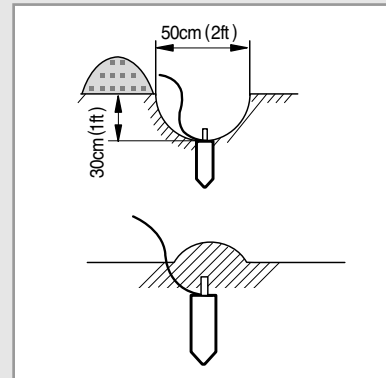
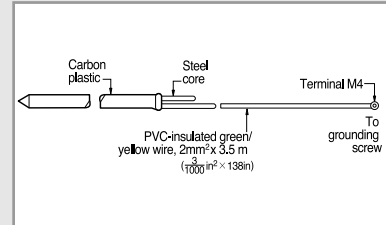

## Fixing the Unit in Position

***The outdoor unit must be installed on a rigid and stable base to avoid any increase in the noise level and vibration, particularly if the outdoor unit is to be installed close to a neighbour. If it is to be installed in a location exposed to strong winds or at a height, the unit must be fixed to an appropriate support (wall or ground).***

- 1 Position the outdoor unit so that the air flow is directed towards the outside.

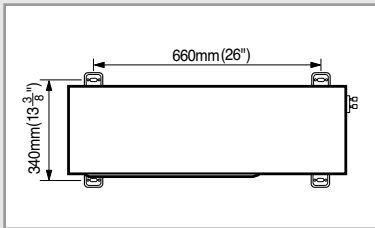

- 2 Attach the outdoor unit to the appropriate support using anchor bolts.

- 3 If the outdoor unit is exposed to strong winds, install shield plates around the outdoor unit, so that the fan can operate correctly.



## Connecting Up and Removing Air In the Circuit

The outdoor units is loaded with sufficient R-22 refrigerant for 5 m(16 <sup>2</sup>/<sub>5</sub> ft) of piping. The air in the indoor unit and in the pipe must be purged. If air remains in the refrigeration pipes, it will affect the compressor, reduce to cooling capacity and could lead to a malfunction. Refrigerant for air purging is not charged in the outdoor unit. Use Vacuum Pump as shown at the figure.

### Adding Refrigerant

Refrigerant must be added if the piping measures more than 5 m(16 <sup>2</sup>/<sub>5</sub> ft) in length (maximum of "A" m/ft). The quantity of additional refrigerant is variable according to the installation situation. Thus, make sure the outdoor unit situation before adding refrigerant. This operation can only be performed by a qualified refrigeration specialist.

☛ If you have used...	Then...
More than 5 m(16 <sup>2</sup> / <sub>5</sub> ft) of the pipes	"B" of refrigerant (R-22) must be added for each extra metre.
Less than 5 m(16 <sup>2</sup> / <sub>5</sub> ft) of piping	The purge time is normal

Model	A	B	
		a	b
ACC2400C	30m	40g	50g
ACC2800C	(100ft)	(0.43oz)	(0.54oz)

For details about the installation situation(a or b), refer to page 44.

- 1 Connect each assembly pipe to the appropriate valve on the outdoor unit and tighten the flare nut.
- 2 Referring to the illustration opposite, tighten the flare nut on section B first manually and then with a wrench, applying the following torque.

Outer Diameter	Torque (kgf·cm)
6.35 mm (1/4")	160(11 <sup>3</sup> / <sub>5</sub> ft·lb)
15.88 mm (5/8")	400(29 ft·lb)

- 3 Connect the charging hose of low pressure side of manifold gauge to the packed valve having a service port as shown at the figure.
- 4 Open the valve of the low pressure side of manifold gauge counter clockwise.
- 5 Purge the air from the system using vacuum pump for about 10 minutes.
  - ◆ Close the valve of the low pressure side of manifold gauge clockwise.
  - ◆ Make sure that pressure gauge show -0.1MPa(-76cmHg) after about 10 minutes. This procedure is very important in order to avoid gas leak.
  - ◆ Turn off the vacuum pump.
  - ◆ Remove the hose of the low pressure side of manifold gauge maintaining a vacuum.
- 6 Set valve cork of both liquid side and gas side of packed valve to the open position.
- 7 Mount the valve stem nuts and the service port cap to the valve, and tighten them at the torque of 183kgf·cm(13ft·lb) with a torque wrench.
- 8 Check for gas leakage.
  - ◆ At this time, especially check for gas leakage from the 3-way valve's stem nuts(A port), and from the service port cap.

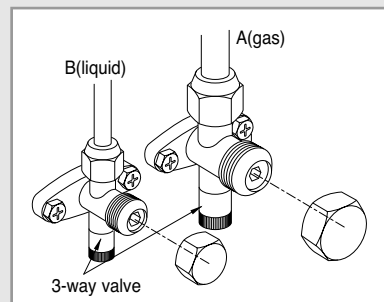
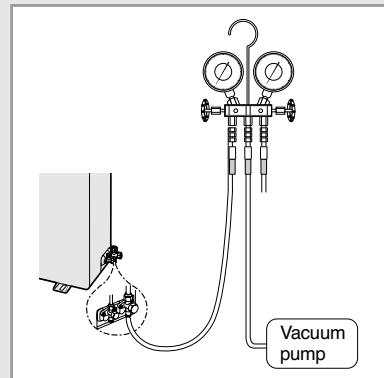
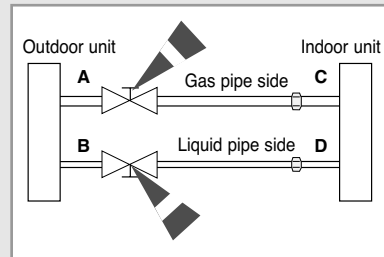

## Performing Leak Tests

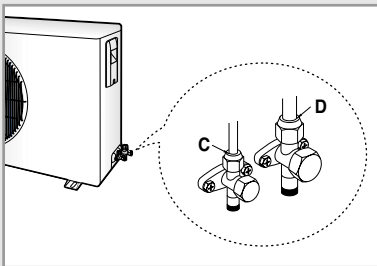
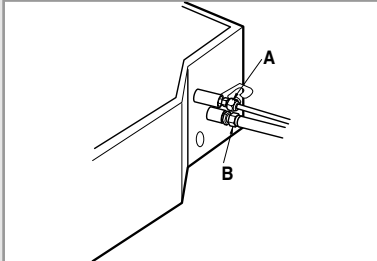

***Before completing the installation (insulation of the hose and piping), you must check that there are no gas leaks.***

To check for gas leaks on the...	Then, using a leak detector, check the...
Indoor unit	Flare nuts at the end of sections A and B.
Outdoor unit	Valves on sections C and D.

## Insulation

**Once you have checked that there are no leaks in the system, you can insulate the piping and hose.**

- 1 To avoid condensation problems, place **heat-resistant polyethylene foam** separately around each refrigerant pipe.

**Note** ♦ Always make the seam of pipes face upwards.

- 2 Wind insulating tape around the pipes and drain hose.

- 3 Finish wrapping insulating tape around the rest of the pipes leading to the outdoor unit.

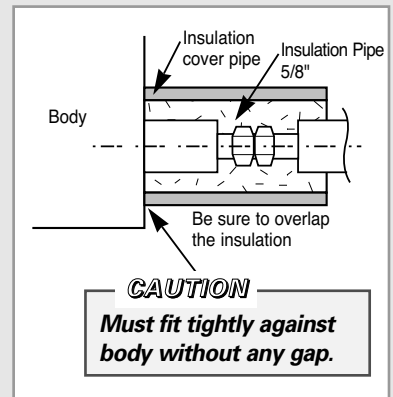
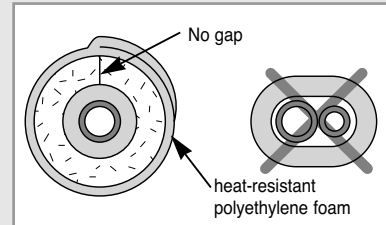

## Installing the Front Panel

1 Open the electrical component box cover removing the screws.

2 Connect the cables of the front panel to the PCB as shown in figure.

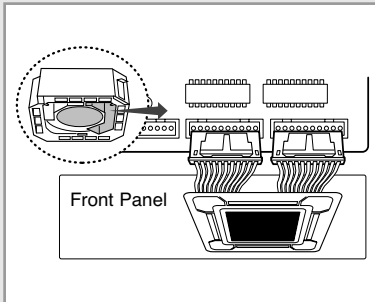

3 Close the electrical component box cover and secure the screws.

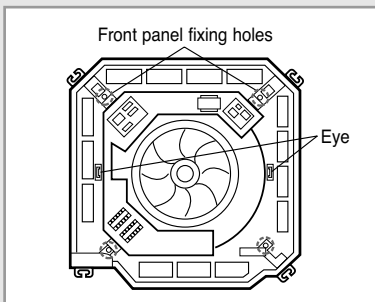

4 Install the front panel using two hooks on the both sides of the indoor unit.

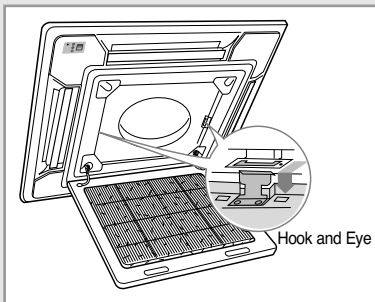

5 Secure the front panel to the indoor unit using the bolts(4EA).

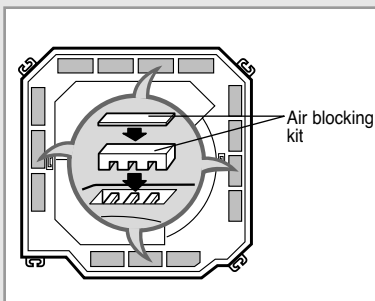

**Note**

- ◆ When user's optional accessory is a wireless remote controller, you have to install the receiver & display unit; refer to page 60.
- ◆ There are four kinds of air blocking kits. Fill up the air outlet(s) with one or more kits depending on the situation, then install the insulation to block air completely.

## Setting Up Option Switches

**IMPORTANT :** Before setting up the option switches, always make sure that you have turned off the main power.

### Main PCB in the Indoor Unit

#### Rotary Digital Switch(SW1)

A user can operate up to sixteen air conditioners by using the wired remote controller. Before controlling more than one air conditioner, you should connect the air conditioner each other. And you must assign addresses to the air conditioners. For further details on connecting air conditioners, refer to page 62. If the user would like to control only one air conditioner, make sure that the arrow is at "0" position.

Turn the arrow to the desired position referring to the table below.

Switch No.	Number of indoor unit(s)	Switch No.	Number of indoor unit(s)
0	One	8	Nine
1	Two	9	Ten
2	Three	A	Eleven
3	Four	B	Twelve
4	Five	C	Thirteen
5	Six	D	Fourteen
6	Seven	E	Fifteen
7	Eight	F	Sixteen

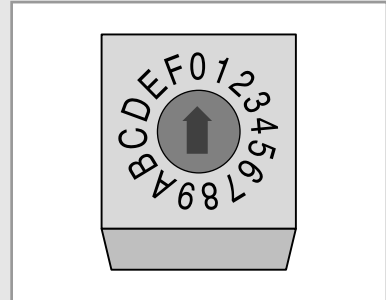

#### DIP Switch(SW2)

Adjust the switch to the desired position referring to the table below.

Switch No.	Option Item	Switch Position		Note
		ON	OFF	
1	Ventilator Fan	Not installed	Installed	Not supplied
2	Drain Pump	Installed	Not installed	
3	Float Switch	Installed	Not installed	
4	Filter Cleaning Cycle	1,000 hours	2,000 hours	
5	Indoor Fan Motor Speed	Normal	High speed	

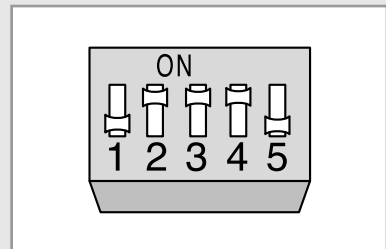

**Note** ◆ Make sure that the No.2 and No.3 switches are at "ON" position.

## Setting Up Option Switches (Cont.)

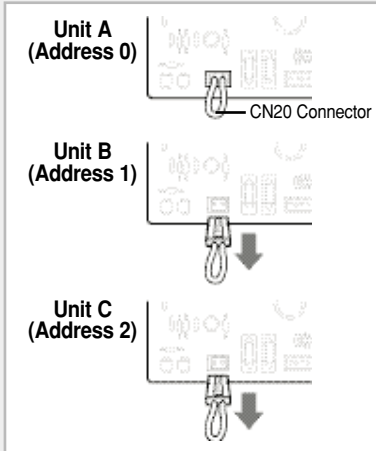

### Sub PCB in the Indoor Unit

#### CN20 Connector

Remove the CN20 connector in the sub PCB, if necessary, referring to the table below. (This procedure is needed only when the user would like to control a group by using the wired remote controller.)

Address	Situation of the CN20 Connector
0	Connected
1 - F	Removed

- Note**
- ◆ Up to 16 air conditioners can be controlled with one wired remote controller.
  - ◆ If the user does not want to control a group, do not remove the CN20 Connector.

### PCB in the Wired Remote Controller

#### Dip Switch(DS01)

Adjust the DIP switch No.2 and/or No.4 to the desired position referring to the table below.

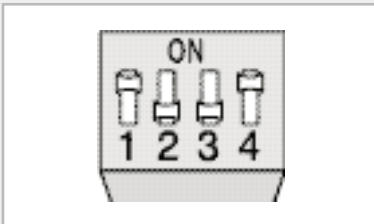

Switch No.	Option Item	Switch Position	
		ON	OFF
1	Type of unit	Cooling only	Heat pump
2	Number of air conditioner(s) controlled by the wired remote controller	Group controlling	One indoor unit controlling
3	Unit of temperature	°F	°C
4	Using wireless remote controller	Can be used	Cannot be used

## Centralized Controller

### DIP Switch(DS01)

Adjust the DIP switch to the desired position referring to the table below.

Switch No.	1	2	3	4	Meaning
Switch Position	OFF	OFF	OFF	OFF	The air conditioner is operated by the controller adjusted last among the wired remote controller, wireless remote controller and centralized controller.
	OFF	OFF	OFF	ON	A user can use wired/wireless remote controller when the centralized controller is switched on. And he/she cannot use the remote controller(s) when the centralized controller is switched off.
	OFF	OFF	ON	OFF	The air conditioner(s) can be controlled by only the centralized controller. The user cannot use the wired/wireless remote controller in this case.

**Note** ◆ You cannot install the centralized controller when the wired remote controller for a group has already been installed.

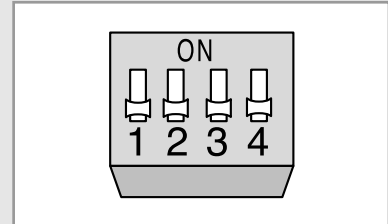

## Transmitter

### Rotary Digital Switch(DS01)

A user can turn on/off up to sixteen air conditioners by using the centralized controller. To use the controller, you must assign addresses to the air conditioners. For further details on connecting air conditioners, refer to page 63. If the user would like to control only one air conditioner, make sure that the arrow is at "0" position.

Turn the arrow to the desired position referring to the table below.

Switch No.	Number of indoor unit(s)	Switch No.	Number of indoor unit(s)
0	One	8	Nine
1	Two	9	Ten
2	Three	A	Eleven
3	Four	B	Twelve
4	Five	C	Thirteen
5	Six	D	Fourteen
6	Seven	E	Fifteen
7	Eight	F	Sixteen

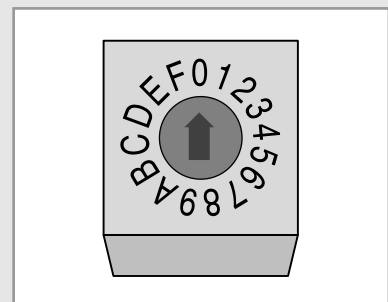

## Setting Up Option Switches (Cont.)

### Original Position of Option Switches

The option switches are preset by the manufacturer. Refer to the table below, if necessary.





Option Place	Component No.	State
Main PCB in the indoor unit	Rotary Digital Switch(SW1)	0
	DIP Switch(SW2)	ON
	Jumper Wire(SW05)	SHORT
Sub PCB in the indoor unit	CN20 Connector	Connected
Wired Remote Controller	DIP Switch(DS01)	OFF
Centralized Controller	DIP Switch(DS01)	OFF
Transmitter	Rotary Digital Switch(DS01)	0

- Note**
- ◆ Before setting up the options, always make sure that you have switched off the main power.
  - ◆ After adjusting the options, you should supply the power. Otherwise, the options will not be applied.



## Wired Remote Controller Installation (Optional)

### Accessories

Wired Remote Controller(1) 	Cable-Tie(2) 	Cable Clamp(5) 	TH M4 X 16 Tapped Screw(7) 
---	---	---	---

1 Disassemble the wired remote controller by using two grooves on the top of it.

2 Secure the rear cover of the wired remote controller on the wall with two screws.

3 Connect the R1, R2 and R3 terminals in the wired remote controller to each R1, R2 and R3 terminals on the electrical component box.

#### CAUTION

- ◆ Do NOT keep the wired remote controller cables with a 220V cable because the remote controller cables have low voltage.
- ◆ Do NOT input 220V power to the R1, R2 and R3 in the wired remote controller.

#### Note Cable Specifications

Cable type	Double-insulation, 3G
Size of cables	0.3mm <sup>2</sup> ~0.75mm <sup>2</sup>
Max. length of electric wires from the indoor unit to the wired remote controller	100m(109 yd)

4 Reassemble the wired remote controller.





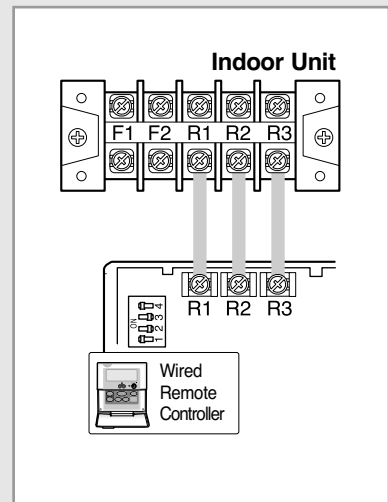
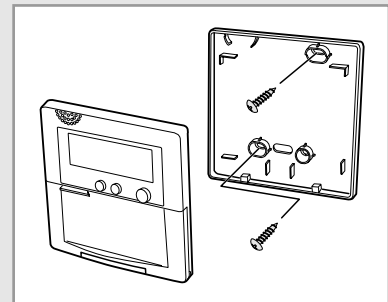

#### CAUTION

- ◆ The optional kits must be installed by an installation specialist.
- ◆ Before installing the optional kits, ensure that you have turned off the main power.
- ◆ All optional kits cables should be installed according to the national wiring rules and you must install them in the wall not to be touched by users.

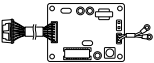

## Centralized Controller Installation (Optional)

### Accessories

Centralized Controller(1) 	Cable-Tie(2) 	Cable Clamp(5) 	TH M4 X 16 Tapped Screw(7) 
Transmitter(1) 	Spacer Support(4) 	Cable-Tie(2) 	

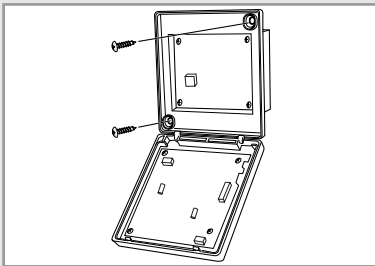

1 Open the centralized controller cover by using two grooves on the top of it.

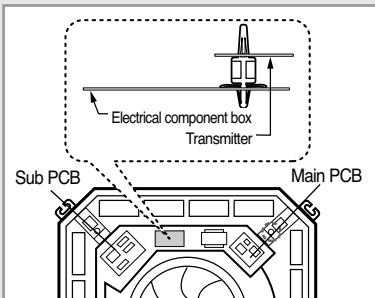

2 Secure the rear cover of the centralized controller on the wall with two screws.

3 Secure the transmitter with four spacer supports into the electrical component box.

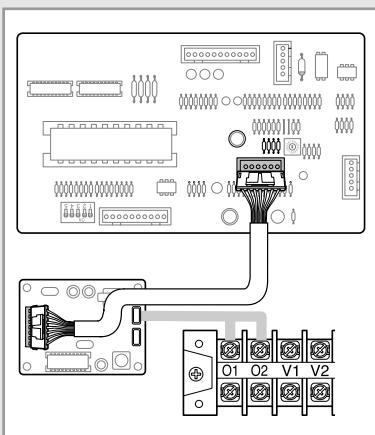

4 Connect the cable from the PCB to the transmitter. And connect another cable from the O1, O2 terminals to the transmitter as shown in figure.

- 5 Connect the O1 and O2 terminals of the centralized controller to the O1 and O2 terminals on the electrical component box as shown in figure.

**CAUTION**

◆ **Do NOT keep the centralized controller cables with a 220V cable because the centralized controller cables have low voltage.**

**Note Cable Specifications**

Cable type	Double-insulation, 2G(Shield Cable)
Size of cables	0.75mm <sup>2</sup> ~1.25mm <sup>2</sup>
Max. length of electric wires from the indoor unit to the centralized controller	1000m(1094 yd)

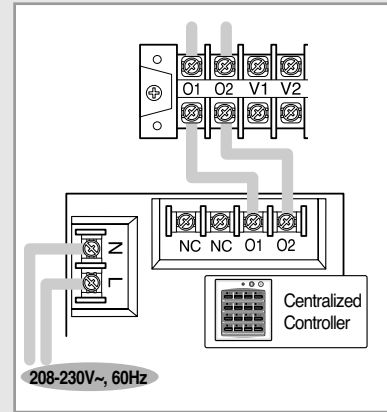

- 6 Connect the power cables.

**Note Cable Specifications**

Cable type	Double-insulation, 2G	Power Supply
Size of cables	0.75mm <sup>2</sup> ~1.25mm <sup>2</sup>	208-230V~, 60Hz

- 7 Reassemble the centralized controller.

**CAUTION**

- ◆ **The optional kits must be installed by an installation specialist.**
- ◆ **Before installing the optional kits, ensure that you have turned off the main power.**
- ◆ **All optional kits cables should be installed according to the national wiring rules and you must install them in the wall not to be touched by users.**

## Receiver & Display Unit Installation (Optional)

### Accessories

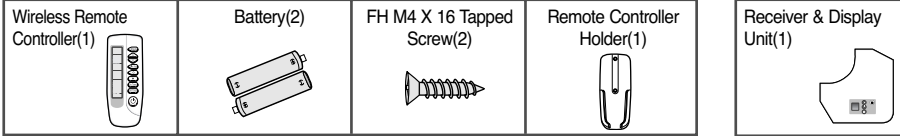

***In case of using the wireless remote controller, you must install the receiver & display unit to the front panel before fixing the panel.***

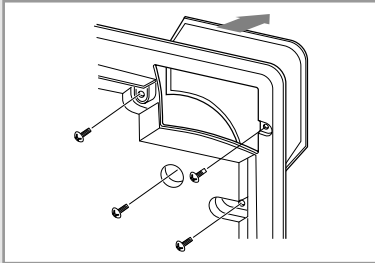

**1** Disassemble four screws on the place where you would like to install the receiver & display unit, inside the front panel.

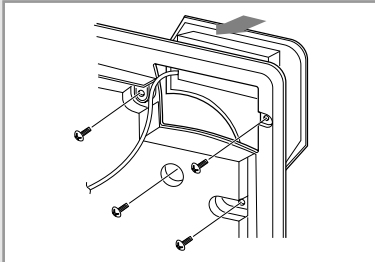

**2** Remove the part of the front panel.

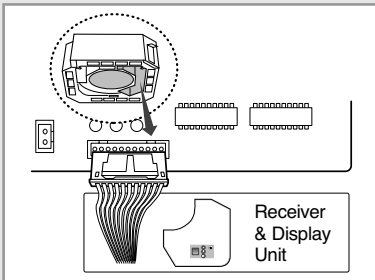

**3** Secure the receiver & display unit with the screws, then install the insulation.

**4** Connect the end of the connector wire to the receiver & display unit and connect the other end of the wire to the electrical component box as shown in figure.

### CAUTION

- ◆ **Optional kits must be installed by an air conditioner specialist.**
- ◆ **Before installing the optional kits, ensure that you have turned off the main power.**

## Bio-Pure Filter Installation (Optional)

*The air conditioner can be fitted with a Bio-Pure filter to remove minute dust particles. The service life of the filter is approximately three months depending on the time during which the air conditioner is used.*

- 1 Remove the vinyl packing from the filter.

**Note** Do not remove the packing from a bio-pure filter until you wish to use the filter, as it will lose its properties.

- 2 Open the front grille by pulling the tabs on the grille.

- 3 Remove the safety clips to open the grille completely.

- 4 Pull out the air filter.

- 5 Locate the bio-pure filter on the center of the air filter.

- 6 Secure the bio-pure filter with four screws.

- 7 Reinstall the filter and the front grille.

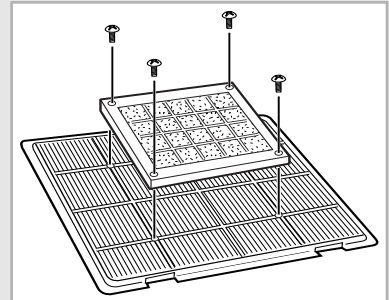

## Controlling a Group

- \* You should adjust the option switches in the electrical component box or on the PCB of the wired remote controller.
- \* **Before setting up the option switches, always make sure that you have turned off the main power.**
- \* After adjusting the options, you should supply the power. Otherwise, the options will not be applied.

### With Wired Remote Controller

A user can operate up to sixteen air conditioners by using the wired remote controller. In this case, the air conditioner can be controlled by only one wired remote controller connected to the indoor unit and cannot be controlled by the others.

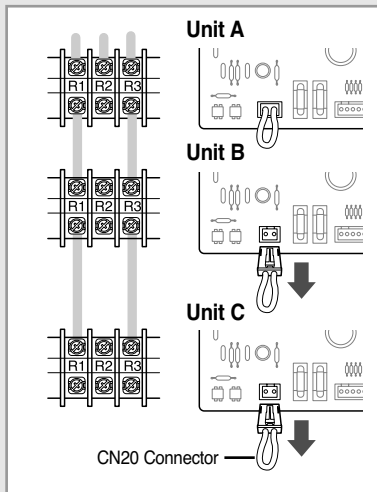

- 1 Connect the R1, R2 and R3 terminals in the wired remote controller to each R1, R2 and R3 terminals in any indoor unit "A".
- 2 Connect the R1 and R3 terminals in the indoor unit "A" to the R1 and R3 terminals in another indoor unit "B".

#### CAUTION

**When connecting the cables, you must keep these :**

- ◆ **The R1 terminals must be connected to the R1s.**
  - ◆ **The R3 terminals must be connected to the R3s.**
  - ◆ **Do not connect the R2 terminals to anywhere.**
- If you connect R2 terminals, the PCB will be damaged.**

- 3 Connect the R1 and R3 terminals of "B" to any indoor unit "C" and connect the others as the same way.
- 4 Adjust the rotary digital switch in the main PCB to the desired position referring to the table below.

Switch No.	Number of indoor unit(s)	Switch No.	Number of indoor unit(s)
0	One	8	Nine
1	Two	9	Ten
2	Three	A	Eleven
3	Four	B	Twelve
4	Five	C	Thirteen
5	Six	D	Fourteen
6	Seven	E	Fifteen
7	Eight	F	Sixteen

- 5 Remove the CN20 connectors on the sub PCBs except the unit connected with remote controller(Address 0).
- 6 Adjust the DIP switch No. 2 in the wired remote controller to "ON" position.

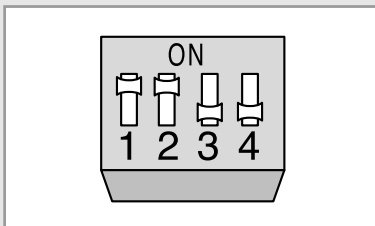

**Note** You cannot install the centralized controller when the wired remote controller for a group has already been installed.

### With Centralized Controller

A user can turn on/off up to sixteen air conditioners by using the centralized controller. In this case, the user can turn on/off all air conditioners or a specific air conditioner connected with the centralized controller. And each air conditioner can be controlled by its own remote controller(s) depending on the setting.

- 1 Connect the O1 and O2 terminals in the centralized controller to the O1 and O2 terminals in the indoor unit "A".
- 2 Connect the O1 and O2 terminals in the indoor unit "A" to the O1 and O2 terminals in another indoor unit "B".
- 3 Connect the O1 and O2 terminals of "B" to any indoor unit "C" and connect the others as the same way.
- 4 Adjust the DIP switch(DS01) in the centralized controller to the desired position referring to the table below.

Switch No.	1	2	3	4	Meaning
Switch Position	OFF	OFF	OFF	OFF	The air conditioner is operated by the controller adjusted last among the wired remote controller, wireless remote controller and centralized controller.
	OFF	OFF	OFF	ON	A user can use wired/wireless remote controller when the centralized controller is switched on. And he/she cannot use the remote controller(s) when the centralized controller is switched off.
	OFF	OFF	ON	OFF	The air conditioner(s) can be controlled by only the centralized controller. The user cannot use the wired/wireless remote controller in this case.

- 5 Adjust the rotary digital switch on the transmitter to the desired position referring to the table on page 55.

**Note** You cannot install the centralized controller when the wired remote controller for a group has already been installed.

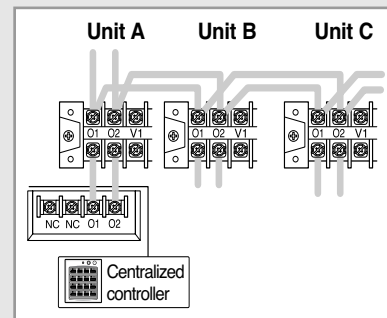
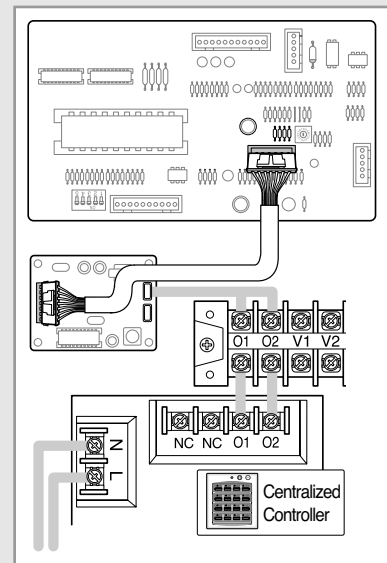

## Checking and Testing Operations

To complete the installation, perform the following checks and tests to ensure that the air conditioner is operating correctly.

Review all the following elements in the installation:

- ◆ Piping connection tightness to detect any gas leakages
- ◆ Connecting wiring
- ◆ Heat-resistant insulation of the piping
- ◆ Drainage
- ◆ Earthing wire connection
- ◆ Correct operations(follow the steps below)

### Wired Remote Controller

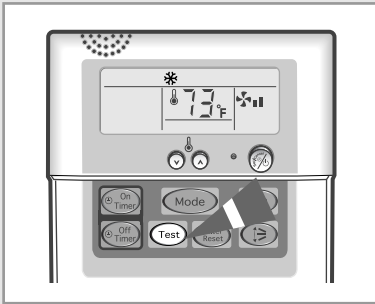

- 1 Supply the power and switch on the air conditioner.

- 2 Press Test button more than 3 seconds without selecting any mode.  
Result: The air conditioner runs in COOL mode for 3 minutes.

**Note** If the error code is displayed, fix the error referring to page 66. And supply the power, restart testing.

- 3 Check that user's option(s) and the outdoor unit operate properly.

**Note** Do not attempt to select the operating mode or to adjust the temperature. It may switch the outdoor unit off.

- 4 Press the Swing(  ) button and check that the air flow blades work properly.

- 5 The air conditioner will switch it off automatically after 3 minutes.

**Note** If the air conditioner does not work because of switching off the thermistor sensor caused by the room temperature, you can operate the air conditioner by using Test button.



## Wireless Remote Controller

- 1 Supply the power and switch on the air conditioner.

---

- 2 Remove the remote controller batteries.

---

- 3 Insert the batteries pressing the On Timer and Off Timer buttons at the same time.

---

- 4 Stop pressing the buttons after inserting the batteries.

---

- 5 Press the  (ON/OFF) button.  
Result: The air conditioner runs in COOL mode for 3 minutes.  
**Note** If the error code is displayed, fix the error referring to page 67. And supply the power, restart testing.

---

- 6 Check that user's option(s) and the outdoor unit operate properly.  
**Note** Do not attempt to select the operating mode or to adjust the temperature. It may switch the outdoor unit off.

---

- 7 Press the Swing() button and check that the air flow blades work properly.

---

- 8 The air conditioner will switch it off automatically after 3 minutes.

---

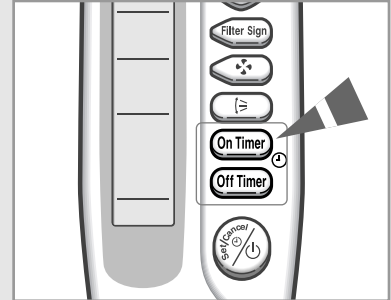
## Troubleshooting

### Wired Remote Controller

If the error occurs,  and the error code are displayed on the wired remote controller. The error code blinks for 5 seconds and it disappears. If you would like to see the error code after disappearing it, press the Test button.

#### Meaning of Error Code

The error code is composed of two-digit figures or letters. The first means an indoor unit address and the second means an error code.

Error Code	Meaning	Checking area
* 1	Indoor unit thermistor sensor error	◆ Indoor unit thermistor sensor ◆ PCB of the indoor unit
* 5	Indoor unit pipe thermistor sensor error	◆ Indoor unit pipe thermistor sensor ◆ PCB of the indoor unit
* 6	Outdoor unit thermistor sensor error	◆ Outdoor unit thermistor sensor ◆ PCB of the outdoor unit
* 9	Float switch error	◆ Drain pump, Float switch ◆ Drain system ◆ DIP switch(SW2) of the indoor unit (The No.2 and No.4 switches must be at "ON" position.)
* A	A Indoor and Outdoor communication error	◆ Communication cables of indoor and outdoor units ◆ PCB of indoor and outdoor units
* C	Wired remote controller communication error	◆ Wired remote controller cables, Wired remote controller ◆ Main/Sub PCB of the indoor unit
* D	Outdoor pipe thermistor sensor error	◆ Outdoor pipe thermistor sensor ◆ PCB of the outdoor unit

**Example** "39" means the address "3" indoor unit has a trouble with a float switch.

## Receiver & Display Unit

If the error occurs, the indicators on the receiver & display unit displays the error.

### Meaning of Error Code

Indicators			Meaning	Checking area
Timer	Operating	Filter		
◐	○	○	Indoor unit thermistor sensor error	◆ Indoor unit thermistor sensor ◆ PCB of the indoor unit
▲	▲	○	Indoor unit pipe thermistor sensor error	◆ Indoor unit pipe thermistor sensor ◆ PCB of the indoor unit
○	▲	▲	Outdoor unit thermistor sensor error	◆ Outdoor unit thermistor sensor ◆ PCB of the outdoor unit
■	○	■	Float switch error	◆ Drain pump, Float switch ◆ Drain system
▲	○	▲	Indoor and Outdoor communication error	◆ Communication cables of indoor and outdoor units ◆ PCB of indoor and outdoor units
■	■	○	Wired remote controller communication error	◆ Wired remote controller cables, Wired remote controller ◆ Main/Sub PCB of the indoor unit
○	○	◐	Outdoor pipe thermistor sensor error	◆ Outdoor thermistor pipe sensor ◆ PCB of the outdoor unit

○ : OFF   ◐ : Blinking   ▲▲ : Blinking at once   ■■ : Blinking alternately

## Explaining Operations to the Owner

*Before leaving the premises on which you have installed the air conditioner, you should explain the following operations to the owner, making reference to the appropriate pages in the owner's instruction booklet.*

---

1 How to start and stop the air conditioner.

---

2 How to select the operating mode and adjust the temperature and fan settings.

---

3 How to set the timers.

---

4 How to remove and clean the air filter.

---

*Once the owner is happy with the basic operations, hand over the owner's instruction booklet and this installation manual for storage in a handy and safe place.*

**Memo**

**THIS AIR CONDITIONER IS MANUFACTURED BY:  
ESTE AIRE ACONDICIONADO HA SIDO FABRICADO POR:  
CE CLIMATISEUR EST FABRIQUE PAR:**

