

A red arrow pointing to the right, positioned to the left of the main title text.

# Polycom<sup>®</sup> RMX<sup>®</sup> 2000 Hardware Guide

**Trademark Information**

Polycom®, the Polycom “Triangles” logo, and the names and marks associated with Polycom’s products are trademarks and/or service marks of Polycom, Inc., and are registered and/or common-law marks in the United States and various other countries.

All other trademarks are the property of their respective owners.

**Patent Information**

The accompanying product is protected by one or more U.S. and foreign patents and/or pending patent applications held by Polycom, Inc.

© 2010 Polycom, Inc. All rights reserved.

Polycom, Inc.  
4750 Willow Road  
Pleasanton, CA 94588-2708  
USA

No part of this document may be reproduced or transmitted in any form or by any means, electronic or mechanical, for any purpose, without the express written permission of Polycom, Inc. Under the law, reproducing includes translating into another language or format.

As between the parties, Polycom, Inc., retains title to and ownership of all proprietary rights with respect to the software contained within its products. The software is protected by United States copyright laws and international treaty provision. Therefore, you must treat the software like any other copyrighted material (e.g., a book or sound recording).

Every effort has been made to ensure that the information in this manual is accurate. Polycom, Inc., is not responsible for printing or clerical errors. Information in this document is subject to change without notice.

## Regulatory Notices

### United States Federal Communication Commission (FCC)

**Part 15: Class A Statement.** This equipment has been tested and found to comply with the limits for a Class A digital device, pursuant to Part 15 of the FCC Rules. Test limits are designed to provide reasonable protection against harmful interference when the equipment is operated in a commercial environment. This equipment generates, uses and can radiate radio-frequency energy and, if not installed and used in accordance with the instruction manuals, may cause harmful interference to radio communications. Operation of this equipment in a residential area is likely to cause harmful interference, in which case the user will be required to correct the interference at his or her own expense.

**Part 68: Network Registration Number.** This equipment is registered with the FCC in accordance with Part 68 of the FCC Rules. This equipment is identified by the FCC registration number.

If requested, the FCC registration Number and REN must be provided to the telephone company.

Any repairs to this equipment must be carried out by Polycom Inc. or our designated agent. This stipulation is required by the FCC and applies during and after the warranty period.

#### United States Safety Construction Details:

- All connections are indoor only.
- Unit is intended for RESTRICTED ACCESS LOCATION.
- Unit is to be installed in accordance with the National Electrical Code.
- The branch circuit overcurrent protection shall be rated 20 A for the AC system.
- This equipment has a maximum operating ambient of 40°C, the ambient temperature in the rack shall not exceed this temperature.

To eliminate the risk of battery explosion, the battery should not be replaced by an incorrect type. Dispose of used batteries according to their instructions.

### CE Mark R&TTE Directive

Polycom Inc., declares that the Polycom RMX™ 2000 is in conformity with the following relevant harmonized standards:

EN 60950-1:2001

EN 55022: 1998+A1:2000+A2:2003 class A

EN 300 386 V1.3.3: 2005

Following the provisions of the Council Directive 1999/CE on radio and telecommunication terminal equipment and the recognition of its conformity.

#### Canadian Department of Communications

This Class [A] digital apparatus complies with Canadian ICES-003.

**Notice:** The Industry Canada label identifies certified equipment. This certification means that the equipment meets telecommunication network protective, operational and safety requirements as prescribed in the appropriate Terminal Equipment Technical Requirements document(s). The Department does not guarantee the equipment will operate to the user's satisfaction.

Before installing this equipment, users should ensure that it is permissible to be connected to the facilities of the local telecommunications company. The equipment must also be installed using an acceptable method of connection. The customer should be aware that compliance with the above conditions may not prevent degradation of service in some situations. Repairs to certified equipment malfunctions, may give the telecommunications company causes to request the user to disconnect the equipment.

Users should ensure for their own protection that the electrical ground connections of the power utility, telephone lines and internal metallic water pipe system, if present, are connected together. This precaution may be particularly important in rural areas.

**Caution:** Users should not attempt to make such connections themselves, but should contact the appropriate electric inspection authority, or electrician, as appropriate.

## Regulatory Notices

### Compliant with European Battery Directive 2006/66/EC

To comply with the European Battery Directive 2006/66/EC, dispose of weak and worn out batteries in accordance with local and national regulations.

### Chinese Communication Certificate

#### 声 明

此为 A 级产品，在生活环境中，该产品可能会造成无线电干扰。在这种情况下，可能需要用户对其干扰采取切实可行的措施。

### Singapore Certificate

Complies with IDA standards DA101619

### Taiwan

#### 警告使用者：

這是甲類的資訊產品，在居住的環境中使用時，可能會造成射頻干擾，在這種情況下，使用者會被要求採取某些適當的對策。

### Russian Communication Certificate

The Polycom RMX™ 2000 complies with the Russian Ministry of Communication requirements stated in certificate OC/1-MM-15.



# Table of Contents

<b>Hardware Description</b> .....	<b>1-1</b>
Main Features .....	1-1
RMX 2000 Specifications .....	1-2
RMX 2000 System Capacities .....	1-3
Conferencing Capacities .....	1-3
Resource Capacities .....	1-5
Site Requirements .....	1-7
Safety Requirements .....	1-7
Rack Mount Safety Precautions .....	1-7
Installation Precautions .....	1-8
RMX 2000 Components .....	1-9
RMX 2000 Front Panel .....	1-9
RMX 2000 Rear Panel .....	1-12
RTM IP .....	1-12
RTM ISDN .....	1-14
ISDN/PSTN Clock Source .....	1-15
Cables Connected to the RTM IP & ISDN Cards .....	1-15
MPM/MPM+ and MPMx Media Cards .....	1-16
MPM+ Resource Capacities per Card Type Assembly .....	1-17
MPMx Resource Capacities per Card Assembly .....	1-18
MPMx, MPM+ and MPM Modes .....	1-18
Operating Mode Selection During Startup / Restart .....	1-19
System Information Changes .....	1-19
RMX 2000 LEDs .....	1-22
RMX 2000 Front Panel LEDs .....	1-22
RMX 2000 Rear Panel LEDs .....	1-25
RTM IP .....	1-25
RTM ISDN .....	1-27
RMX Chassis Types .....	1-28
Component Replacement .....	1-29
Types of Ejector Levers on RMX Components .....	1-30
Using the All Metal Ejector Lever .....	1-30
Using the Modified PMC Compatible Ejector Lever .....	1-30

## Table of Contents

---

Replacing the CNTL Module .....	1-31
Replacing the Power Supply Module .....	1-33
Replacing the Fan Drawer .....	1-34
Replacing a Faulty MPM/MPM+/MPMx Card .....	1-35
Removing the MPM/MPM+/MPMx Card from the MCU .....	1-35
Installing the Replacement MPM/MPM+/MPMx Card .....	1-36
Installing a New MPM/MPM+/MPMx Card in a Powered On RMX 2000 .....	1-36
Replacing a RTM ISDN Card .....	1-37
Replacing the RTM IP Card .....	1-39

---

# Hardware Description

This Hardware Guide provides information on the RMX 2000 and its components. This system utilizes a modular “universal slot” platform, whose components are designed for high performance, capacity and reliance.

## Main Features

The Polycom RMX 2000 offers the following features:

- Linux® based
- Chassis based on the ATCA standard
- Support for standard network interfaces (IP, ISDN and LAN) and large number of ports.
- H.323, SIP video, PSTN and ISDN
- New hardware technologies
- Telco grade high availability, redundancy, on-line upgrading and dynamic resource allocation
- Easy integration of conference elements into external network management
- Enhanced Continuous Presence (multi-image video)
- IVR (Interactive Voice Response) module

# RMX 2000 Specifications

**Table 1-1** Polycom RMX 2000 Specifications

<b>Physical</b>	
Height	3U (13.25 cm.)
Width	19" (48.26 cm.)
Depth	15.74" (40 cm.)
Weight	Up to 16.5 Kg.
<b>Media Protocols</b>	
Audio	G.711, G. 719, G.722, G.722.1, G.729A, G.723.1, Siren14, Siren 22.
Video	H.261, H.263, H.264.
<b>Network Interfaces</b>	
IP, ISDN, PSTN and LAN	H.323, SIP, PSTN, LAN and ISDN.
<b>Power Supply</b>	
AC Input/ Range, BTU	Voltage range: 100-240 VAC, 4-8 AMP, 50/60 Hz. Maximum BTU output: 3070 per hour.
<b>Power Consumption</b>	
AC Maximum Power consumption	900 Watts.
<b>Environment</b>	
Operating temperature	0°– 40°C (22°– 104°F).
Storage temperature	-30°– 70°C (40°– 158°F).
Relative humidity	15% - 90% no condensing.
Operating altitude	Up to 3,000 m (10,000 ft.).
Operating ESD	4 kV.



# RMX 2000 System Capacities

## Conferencing Capacities

The following table summarizes the different conferencing capacities.

**Table 1-2** System Functions and Capacities RMX 2000

System Functions	MPM Mode	MPM+ Mode	MPMx Mode
<i>Maximum number of Video participants in a conference</i>	80	160	180
<i>Maximum number of PSTN participants in a conference</i>	400	400	400
<i>Maximum number of VOIP participants in a conference</i>	400	800	720
<i>Maximum number of Audio calls per second</i>	5	5	5
<i>Maximum number of Video calls per second</i>	2	2	2
<i>Maximum number of conferences</i>	200	400	400
<i>Maximum number of Meeting Rooms</i>	1000	1000	1000
<i>Maximum number of Entry Queues</i>	40	40	40
<i>Maximum number of Profiles</i>	40	40	40
<i>Maximum number of Conference Templates</i>	100	100	100
<i>Maximum number of SIP Factories</i>	40	40	40
<i>Maximum number of IP Services</i>	1	1	1
<i>Maximum number of ISDN Services</i>	2	2	2
<i>Maximum number of IVR Services</i>	40	40	40

**Table 1-2** System Functions and Capacities RMX 2000

<b>System Functions</b>	<b>MPM Mode</b>	<b>MPM+ Mode</b>	<b>MPMx Mode</b>
<i>Maximum number of Recording Links</i>	20 (default)	20 (default)	20 (default)
<i>Maximum number of IVR Video Slides</i>	150	150	150
<i>Maximum number of Log Files (1Mb max.)</i>	4000	4000	4000
<i>Maximum number of CDR Files</i>	2000	2000	4000
<i>Maximum number of Fault Files</i>	1000	1000	1000
<i>Number of Participant alerts</i>	Unlimited	Unlimited	Unlimited
<i>Maximum number of concurrent RMX Web Client connections to the MCU</i>	20	20	20
<i>Maximum number Address Book entries</i>	4000	4000	4000
<i>Maximum number of Users</i>	100	100	100
<i>Maximum number of Gateway Profiles</i>	40	40	40
<i>Maximum number of Reservations (internal Scheduler)</i>	2000	2000	2000

## Resource Capacities

The following table summarizes the resource capacities for a fully loaded system per card type per resolution in CP conferencing mode

**Table 1-3** System Resource Capacities per Resolution per Card Type in CP

Audio/Video and Resolution	Resources with MPM	Resources with MPM+	Resources with MPMx
<i>PSTN</i>	400	400	400
<i>VOIP</i>	400	800	720
<i>CIF H.263</i>	80	160	120
<i>CIF H.264</i>	80	160	180
<i>CIF 60 H.264</i>	N/A	60	120
<i>SD30 H.264</i>	20	60	120
<i>4CIF H.263</i>	20	60	60
<i>4CIF 60 /SD 60</i>	N/A	40	60
<i>720p30</i>	20	40	60
<i>1080p30fps Asymmetric</i>	N/A	20	30
<i>1080p30fps Symmetric</i>	N/A	N/A	30
<i>ISDN</i>	7 E1 or 9 T1 (per RTM ISDN card)		

The following table summarizes the resource capacities for a fully loaded system per card type per line rate in VSW conferencing mode

**Table 1-4** System Resource Capacities per Line Rate per Card Type in VSW

<b>Audio/Video and Resolution</b>	<b>Resources with MPM</b>	<b>Resources with MPM+</b>	<b>Resources with MPMx</b>
<i>VSW 2Mb</i>	80	160	160
<i>VSW 4Mb</i>	40	80	80
<i>VSW 6Mb</i>	N/A	40	40
<i>ISDN</i>	7 E1 or 9 T1 (per RTM ISDN card)		

## Site Requirements

This section describes the requirements your site must meet for safe installation and operation of the system.

### Safety Requirements

For your protection, please read these safety instructions completely before operating the equipment.

- Look carefully for potential hazards in your work area: moist floors, ungrounded power cables, frayed power cords, missing safety grounds and so forth.
- Locate the main circuit breaker within the room.
- Locate the emergency power **OFF** switch within the room.
- Never assume that power is disconnected from a circuit.
- Use only the power cord supplied with the system.
- The power cord should only be connected to a power outlet that has a protective ground contact.
- Ensure that the power cord is easily accessible from the back of the system at all times.
- Place the equipment in a well-ventilated area where the vents are free from obstruction.
- Do not place heavy objects directly on top of the RMX 2000 unit.
- Do not use liquids around your equipment.

### Rack Mount Safety Precautions

The following precautions should be followed with regards to rack mount safety:

- Keep the area around the RMX 2000 clean and free of clutter.
- Decide on a suitable location for the equipment rack that will hold the RMX 2000 unit. It should be situated in a clean, dust-free area that is well ventilated. Avoid areas where heat, electrical noise and electromagnetic fields are generated. You will also need it placed near a grounded power outlet.
- Ensure that the leveling jacks on the bottom of the rack are fully extended to the floor with the full weight of the rack resting on them.

- In a single rack installation, stabilizers should be attached to the rack.
- In multiple rack installations, the racks should be coupled together.
- Always make sure the rack is stable before extending a component from the rack.
- You should extend only one component at a time - extending two or more simultaneously may cause the rack to become unstable.
- Before you install the rails, determine the placement of each component in the rack.
- Install the heaviest components on the bottom of the rack first, and then work up.
- Allow the power supply units to cool before touching them.
- Always keep the rack's trays and card's slots closed when not servicing, to maintain proper cooling.

## Installation Precautions



When handling electronic components, standard anti-static precautions must be observed:

- Wear a grounding strap
- Handle cards by their edges only and do not touch their components or connector pins
- Keep components in anti-static bags, when not installed in the RMX2000

The following precautions should be followed with regards to installation of the RMX 2000:

- Use a regulating uninterruptable power supply (UPS) to protect the RMX 2000 from power surges and voltage spikes, to keep your MCU operating in case of a power failure.
- Place the RMX 2000 on a hard, flat surface such as a desktop or mount it on 19" rack.
- The airflow of the RMX 2000 is from right to left. Be sure that the areas in the left and right side of the system are clear for proper ventilation.

## RMX 2000 Components

On the RMX 2000 components are located on both the front and rear of the MCU as listed in Table 1-5, "*Polycom RMX 2000 Component Description*". For more information see the descriptions of the "*RMX 2000 Front Panel*" on page 1-9 and "*RMX 2000 Rear Panel*" on page 1-12.



Please verify the type of chassis used on your RMX 2000. Starting with version 4.0, a new environmentally friendly RMX 2000 chassis is in use. For more information, contact your next level of support.

### RMX 2000 Front Panel

Figure 1-1 shows the front panel of the RMX 2000. The front panel provides access to the RMX 2000 main CNTL modules, MPM/MPM+/MPMx modules, Power Supply drawer, Status LEDs, and Fans.

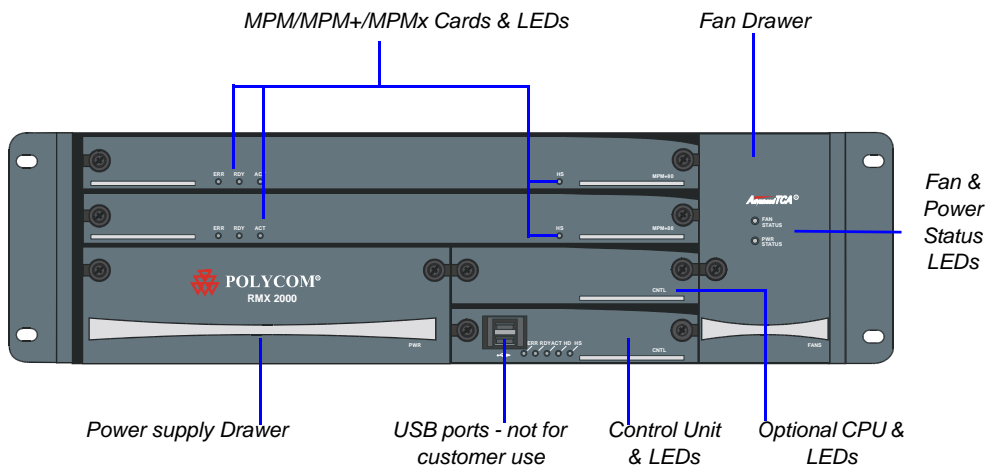

**Figure 1-1** RMX 2000 Front Panel

**Table 1-5** Polycom RMX 2000 Component Description

Component	Description
CNTL (CPU) Module	The CNTL module controls and manages the RMX 2000. The CNTL module has an ComExpress Pentium-M 1.4GHz processor, a 40GB hard disk drive, 1GB Compact Flash and 1GB of DDR RAM. The Operating System is Linux.
Power Supply Drawer	The Power Supply drawer is located below the MPM/MPM+/MPMx Cards and is connected to the backplane by means of a power connector. It operates at 100-240 volts AC 50/60 Hz, and provides +48VDC 700W output with built-in load sharing capabilities.
Fan Drawer	Three fans are mounted sideways in a drawer. Airflow is from right to left, and out the side of the MCU. The drawer is connected to the Back-plane by a connector.
Multi Processor Module (MPM) Card	The MPM cards perform the various RTP, audio and video processing functions on the RMX 2000. MPM cards are based on the ATCA standard, with a card manager (CM) and up to 26 720MHz TI DSP's. Two types are available: <ul style="list-style-type: none"><li>• MPM - F - 26 DSP's</li><li>• MPM - H - 13 DSP's</li></ul>



**Table 1-5** *Polycom RMX 2000 Component Description (Continued)*

Component	Description
<p>Multi Processor Module+ (MPM+) Card</p>	<p>The MPM+ cards, perform the various RTP, audio and video processing functions on the RMX 2000 unit. TI C6455 processors are at the core of each MPM+ card which are available in the following assemblies:</p> <ul style="list-style-type: none"> <li>• MPM+20 (20 CIF resources)</li> <li>• MPM+40 (40 CIF resources)</li> <li>• MPM+80 (80 CIF resources)</li> </ul> <p><b>Notes:</b></p> <ul style="list-style-type: none"> <li>• The MPM+ card(s) can only work with software version 4.0 or above. Ensure that software appropriate to the MCU hardware configuration is installed in the MCU.</li> <li>• The MPM+ card can work only with a new environmentally friendly D-type chassis and is disabled when inserted in a C-type chassis.</li> </ul>
<p>Multi Processor Modulex (MPMx) Card</p>	<p>The MPMx cards, perform the various RTP, audio and video processing functions on the RMX 2000 unit. TI processors are at the core of each MPMx card which are available in the following assemblies:</p> <ul style="list-style-type: none"> <li>• MPMx -S</li> <li>• MPMx -D</li> </ul> <p><b>Notes:</b></p> <ul style="list-style-type: none"> <li>• The MPM+ card(s) can only work with software version 7.0 or above. Ensure that software appropriate to the MCU hardware configuration is installed in the MCU.</li> <li>• The MPM+ card can work only with a new environmentally friendly D-type chassis and is disabled when inserted in a C-type chassis.</li> </ul>

## RMX 2000 Rear Panel

The RMX 2000 rear panel contains the RTM IP card and optionally, the RTM ISDN card. The RTM IP card must be located on the bottom slot in the rear of the RMX 2000. In addition, the rear panel houses the main power switch, AC inlet, a circuit breaker, and additional communications ports.

### RTM IP

The RTM IP card provides system management based on the ATCA standard and connects to the backplane. It controls and monitors the system fans and regulates power supply. This card contains an Ethernet Switch that manages the network of the system, routes data between the cards and components of the system and provides connectivity to external IP networks.

The RTM IP card connections include:

- 3 LAN ports
- 10/100Mb ShMG port (Future Use)
- 1 Serial port (Future Use)
- 1 USB port



LAN1, LAN3 and the 10/100Mb ShMG ports shall not be used and the plastic caps covering those ports should not be removed.

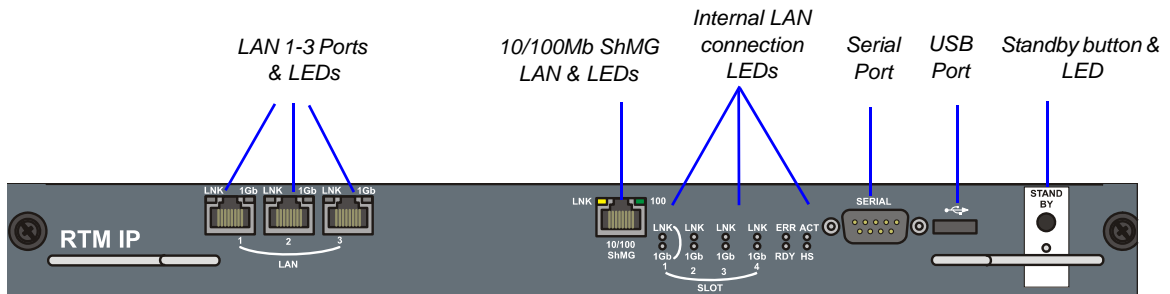

*LAN1, LAN 3, ShMG and the Serial ports are only for debugging and not for customer use*

**Figure 1-2** RMX 2000 RTM IP Rear Panel Layout

The following items appear on the RMX 2000 rear panel:

**Table 1-6** RMX 2000 Rear Panel - RTM IP Component Description

Item	Description
LAN 1	NA - Disconnected. <b>Note:</b> LAN 1 is covered with a plastic cap that should not be removed.
LAN 2	Used for the Network connection.
LAN 3	For Remote Access only using the <i>Alternate Management Network</i> . For more information, see the <i>RMX 2000 Administrator's Guide, Appendix F: "Alternate Management Network"</i> on page <b>G-1</b> . <b>Note:</b> When not in use, LAN 3 is covered with a plastic cap that should not be removed.
10/100 ShMG	NA - For debugging purposes only. <b>Note:</b> 10/100 ShMG is covered with a plastic cap that should not be removed.
Serial	NA - For debugging purposes only.
USB	USB key connection. For more information, see the <i>RMX 2000 Getting Started Guide, "First Time Installation and Configuration"</i> on page <b>2-1</b> .
Standby button	Toggle between CPU activation and standby.

## RTM ISDN

The RTM ISDN card connects directly to an MPM/MPM+/MPMx. The RTM ISDN card routes data between the MPM/MPM+/MPMx cards and components of the system, converts ISDN T1/E1 media to IP packets and provides connectivity to external ISDN networks.

The RTM ISDN card is installed on the rear panel of the RMX interfaces between the RMX unit and the ISDN/PSTN switch. In an RMX with a single MPM/MPM+/MPMx card – the RTM ISDN card must be installed in the rear panel slot on the same level as the MPM/MPM+/MPMx card. In an RMX with two MPM/MPM+/MPMx cards – the RTM ISDN card can be installed in either of the two rear panel card slots.

Up to two RTM ISDN cards can be installed in one RMX 2000. Up to a total of 14 E1 or 18 T1 PRI cables can be installed with two MPM/MPM+/MPMx and RTM ISDN cards.

Each RTM ISDN card includes the following connections:

- 7 E1 or 9 T1 PRI lines that can be plugged into any of the 12 connections as shown in Figure 1-3.



E1 and T1 spans cannot nbe connected simultaneously to the same card, therefore, it is not possible to have a mixed E1 and T1 ISDN Network Service.

- 1 LAN port

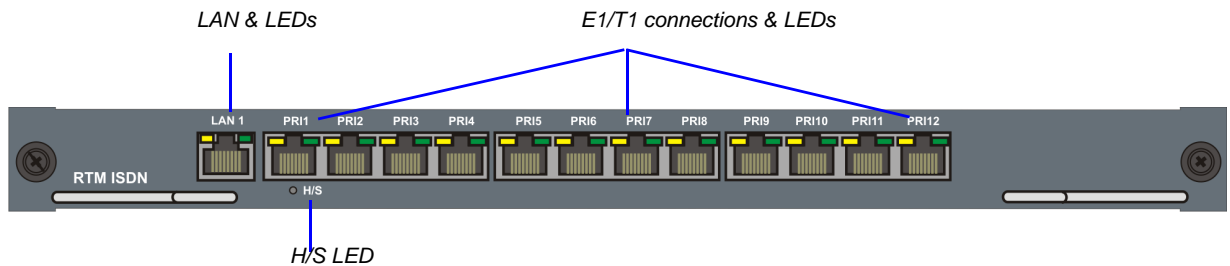

**Figure 1-3** RMX 2000 RTM ISDN Rear Panel Layout



The RTM ISDN card supports 200 audio participants, regardless of whether the spans are E1 or T1.

## ISDN/PSTN Clock Source

Each RTM ISDN card has its own primary and secondary clock source. The first span to synchronize becomes the primary clock source and the second span to synchronize becomes the secondary clock source. This clock is used to synchronize ISDN spans only (it is not the system clock). A single clock source triggers an alarm that can be turned off by setting the appropriate flag in the system configuration.

## Cables Connected to the RTM IP & ISDN Cards

All external connectors are located on the rear panel.

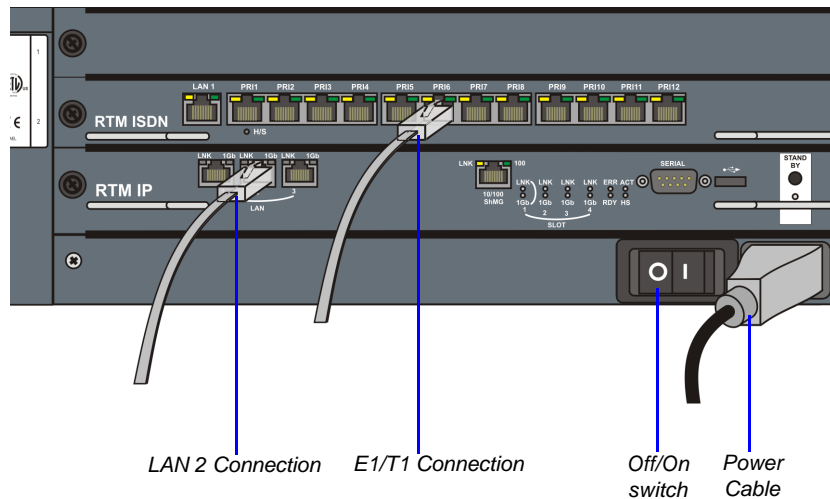

Figure 1-4 RMX 2000 Rear Panel View with Cables



Do not remove the protective caps from LAN1, LAN3 and ShMG ports.

## MPM/MPM+ and MPMx Media Cards

The RMX unit can work with either MPM or MPM+/MPMx (but not with both simultaneously) media cards. The card type installed in the system determines the *Card Configuration Mode*.

MPM+ cards are supported only with D-type chassis and software version 4.x and later.

MPMx cards are supported only with D-type chassis and software version 7.x.

For more details about the chassis type, see "RMX Chassis Types" on page 1-28.

ISDN support is the same for all card types.

Table 2 summarizes the resource capacities of the various resolutions per card type in CP Conferencing Mode.

**Table 2** MPMx, MPM+ and MPM Resource Capacity per Resolution in CP

Resource Type	Maximum Possible Resources Per Card		
	MPM	MPM+	MPMx
HD720p60/HD1080p30 Symmetric	Not Applicable	Not Applicable	15
HD720p60/HD1080p30 Asymmetric		10	15
HD720p30	10	20	30
SD	10	30	60
CIF (H.264)	40	80	90
CIF (H.263)	40	80	60
Audio only (VoIP)	200	400	360

Table 3 summarizes the resource capacities per line rate per card type in VSW Conferencing Mode.

**Table 3** MPMx, MPM+ and MPM Resource Capacity per Line Rate in VSW

Resource Type	Maximum Possible Resources Per Card		
	MPM	MPM+	MPMx
VSW 2Mbps	40	80	80
VSW 4Mbps	20	40	40
VSW 6Mbps	-	20	20
Audio only (VoIP)	200	400	360

## MPM+ Resource Capacities per Card Type Assembly

The MPM+ card offers increased resource capacities and capabilities. Three MPM+ card assemblies are available: MPM+ 80, MPM+ 40 and MPM+ 20 offering various resource capacities for CP conferences.

### In CP conferences:

- Frame rate has been increased – with HD720p now up to 60fps.
- Video resolution has been increased up to HD1080p.
- Bandwidth is up to 4 Mbps.

Table 4 summarizes the increased video capacities of the various MPM+ card assemblies.

**Table 4** MPM+ Card Assemblies and Capacities for CP Conferences

Card Type	Resources						Bandwidth
	Voice	CIF	SD @30fps	HD720p @30fps	HD720p @60fps	HD1080p @30fps	
MPM+ 80	400	80	30	20	10	10	Up to 4Mbps
MPM+ 40	200	40	15	10	5	5	
MPM+ 20	100	20	7	5	2	2	

## MPMx Resource Capacities per Card Assembly

The MPMx card offers increased resource capacities and capabilities. Two MPM+ card assemblies are available:

- MPMx-D
- MPMx-S

Table 5 summarizes the video capacities of the two MPMx card assemblies.

**Table 5** MPMx – Resource Capacity per Card

Resource Type	MPMx - S	MPMx - D
Voice (IP)	180	360
H.263 CIF	30	60
H.263 4CIF15	15	30
H.264 CIF/VSW	45	90
SD H.264	30	60
HD720p30	15	30
HD720p60/ HD1080p30	8	15 (Symmetrical)

## MPMx, MPM+ and MPM Modes

MPMx, MPM+ and MPM cards installed in the system cannot be used simultaneously. The card type installed in the system determines the *Card Configuration Mode*. Therefore, the RMX can operate in either MPM, MPM+ or MPMx mode.

- **MPMx Card Configuration Mode** is the mode in which the RMX operates to fully utilize the increased power and capacity of MPMx cards.
- G.719 audio algorithm is not supported with MPMx.



## Operating Mode Selection During Startup / Restart

When started with Version 7.x installed, the RMX enters *MPMx Mode* by default when no media cards are installed.



- The RMX switches between *MPM*, *MPM+* and *MPMx Card Configuration Modes* when *MPM/MPM+/MPMx* cards are removed or swapped while the system is running.
- The switch between *Card Configuration Modes* occurs during the **next** restart.
- Installing or swapping *MPM/MPM+/MPMx* cards while the system is off will not cause a switch in the *Card Configuration Mode* when the system is restarted – it will restart in the *Card Configuration Mode* that was active previous to powering down.

## System Information Changes

The *System Information* includes *License Information*, and general system information, such as system memory size and *Media Card Configuration Mode*, which in version 7.0 includes the *MPMx Mode*.

*Table 6* summarizes the *Operating Mode After Next Restart* resulting from of adding or swapping *MPM/MPM+/MPMx* cards in a running system.

**Table 6** RMX Card Configuration Mode After Next Restart

Current Operating Mode	Media Cards Installed	Card(s) Supported	Card(s) Disabled	Operating Mode After Next Restart
MPMx	MPM	None	All	MPM
	MPM+	None	All	MPM+
	MPM and MPMx	MPMx Only	MPM	MPMx
	MPM+ and MPMx	MPMx Only	MPM+	MPMx

**Table 6** RMX Card Configuration Mode After Next Restart

Current Operating Mode	Media Cards Installed	Card(s) Supported	Card(s) Disabled	Operating Mode After Next Restart
<b>MPM+</b>	<b>MPM</b>	None	All	MPM
	<b>MPM+</b>	All	None	MPM+
	<b>MPM and MPM+</b>	MPM+ Only	MPM	MPM+
	<b>MPM+ and MPMx</b>	MPM+ Only	MPMx	MPMx
<b>MPM</b>	<b>MPM</b>	All	None	MPM
	<b>MPM+</b>	MPM Only	MPM+	MPM+
	<b>MPM and MPM+</b>	MPM	MPM+	MPM+
	<b>MPM and MPMx</b>	MPM Only	MPMx	MPMx

**Example 1:**

**Current status**

- An RMX has two *MPM* cards installed.
- The *Card Configuration Mode* is **MPM**.
- Both *MPM* cards are **enabled**.

**Action**

1. Remove one *MPM* card.
2. Insert one *MPMx* card.

**Result**

- The *Card Configuration Mode* remains **MPM**.
- The remaining *MPM* card remains **enabled**.
- The inserted *MPMx* card is **disabled**.

**After Reset**

- The *Card Configuration Mode* is **MPMx**.
- The inserted *MPMx* card is **enabled**.

- The remaining *MPM* card is **disabled**.

**Example 2:**

**Current status**

- An RMX has one *MPMx* card installed.
- The *Card Configuration Mode* is **MPMx**.
- and the *MPMx* card is **enabled**.

**Action**

1. Remove the *MPMx* card.
2. Insert one *MPM* card.

**Result**

- The *Card Configuration Mode* remains **MPMx**.
- The inserted *MPM* card is **disabled**.

**After Reset**

- The *Card Configuration Mode* is **MPM**.
- The inserted *MPMx* card is **disabled**.
- The remaining *MPM* card is **enabled**.

**Example 3:**

**Current status**

An RMX has *MPM+* card installed.

The *Card Configuration Mode* is **MPM+**.

and the *MPM+* card is **enabled**.

**Action**

- Insert one *MPMx* card.

**Result**

- The *Card Configuration Mode* remains **MPM+**.
- *MPM+* card is **enabled**.
- The inserted *MPMx* card is **disabled**.

**After Reset**

The *Card Configuration Mode* is **MPMx**.

The inserted *MPMx* card is **enabled**.

The remaining *MPM+* card (if not removed) is **disabled**.

## RMX 2000 LEDs

The RMX includes LEDs located on the front panel and rear panel. In the front panel, the LEDs reflect the state of the components. The LEDs on the rear panel indicate the state of the external connections and the status of the RTM IP card.

### RMX 2000 Front Panel LEDs

The following items appear on the RMX 2000 front panel:

**Table 1-1** RMX 2000 Front Panel LED's

Component	LED ID	LED Color	Description
Fan Status		Green	OK.
		Red	Warning - Fan or power failure.
Power Status		Green	OK.
		Red	Error - Problem with power supply. When the power cable is unplugged, the FAIL LED is lit 2-3 seconds before turning OFF.

**Table 1-1** RMX 2000 Front Panel LED's (Continued)

Component	LED ID	LED Color	Description
MPM/MPM+ Card	ERR	Red	ON - Major error on card. Flashes - During card startup.
	RDY	Green	ON - The card has completed startup successfully. Flashes - During card startup.
	ACT	Amber	ON - At least one participant is connected to a conference. Flashes - During card startup.
	HS	Blue	Flashes - Shut down process initiated by lightly pulling the CPU ejector levers. This LED flashes in synchronization with the CNTL's card's HS LED.  ON - Card is in a power down mode. <b>Card removal Initiated</b> - The card can be removed safely once the CPU ejector levers are fully open. <b>Card Insertion Initiated</b> - If during the startup phase the blue HS LED remains lit, please ensure that the card is properly seated in the chassis. If this problem persists, contact your next level of support.

**Table 1-1** RMX 2000 Front Panel LED's (Continued)

Component	LED ID	LED Color	Description
CNTL Unit	ERR	Red	ON - Major system error. In case of an active alarm this light is ON, and the RDY green is OFF.
			OFF - Normal.
			Flashes - During system startup.
	RDY	Green	ON - CPU card has successfully completed startup. This light turns green after completing the entire system configuration.
			OFF - Turns OFF when the ERR red LED is activated.
			Flashes - During system startup.
	ACT	Amber	ON - At least one endpoint is connected to the system. Flashes - During system startup.
	HD	Red	OFF - Normal.
			Flashes - Hard disk is active.
	HS	Blue	Flashes - Indicates when the power down process is initiated on an MPM/MPM/MPMx + card. This LED flashes in synchronization with the MPM/MPM+/MPMx's cards HS LED. OFF - Normal
			ON - CPU may be removed.

## RMX 2000 Rear Panel LEDs

### RTM IP

The following LEDs appear on the RTM IP card:

**Table 1-2** RMX 2000 RTM IP LEDs

Component	LED Name	LED Color	Description
LAN LEDs (1-3)	LNK	Green	ON with an active network connection, flickers with Packet activity.
	1 Gb	Amber	ON with a 1Gb online connection, flickers with Packet activity.
10/100 ShMG LEDs	LNK	Green	ON with an active network connection, flickers with Packet activity.
	100	Amber	ON when the active network is 10/100Mb, flickers with Packet activity.
SLOT (1-4) LEDs	LNK (1-4)	Green	ON with an active network connection, flickers with Packet activity.
	1Gb (1-4)	Amber	ON with a 1Gb online connection, flickers with Packet activity.

**Table 1-2** RMX 2000 RTM IP LEDs (Continued)

<b>Component</b>	<b>LED Name</b>	<b>LED Color</b>	<b>Description</b>
ShMG LEDs	ERR	Red	ON - Major error on RTM card. Flashes - During system startup.
	ACT	Red	ON - Packet flow to and from the MCU chassis. Flashes - During system startup.
	RDY	Green	ON - RTM IP card has successfully completed startup. Flashes - During system startup.
	HS	Blue	OFF - Normal.
Flashes - During power down process.			
ON - RTM IP card may be removed.			
Standby LED		Blue	ON - CPU & System are in a standby (OFF) mode.



## RTM ISDN

The following LEDs appear on the RTM ISDN:

**Table 1-3** RMX 2000 RTM ISDN LEDs

Function Name	LED Name	LED Color	Description
LAN LED (1)	LNK	Green	ON with an active network connection, flickers with Packet activity.
	1 Gb	Amber	ON when 1Gb connection is online, flickers with Packet activity.
ShMC LEDs	H/S	Blue	OFF - Normal.
			Flashes - This LED is activated when the MPM/MPM+ card Hot Swap functionality initiates a power off routine on the MPM/MPM+/MPMx and RTM ISDN cards.
			ON - Power on the RTM ISDN card has been switched OFF. This LED is activated by the MPM/MPM+/MPMx card when the MPM/MPM+/MPMx's card Hot Swap functionality powers off the MPM/MPM+/MPMx and RTM ISDN cards.

## RMX Chassis Types

The RMX chassis can be of type A/B/C or D. The environmentally friendly D-type chassis (indicated by the letter D in the Part Number) is required for use with MPM+ card(s).

The chassis type can be viewed in the Hardware Monitor, by right clicking **Slot 0** and then clicking **Properties**.

The *RMX 2000 - General Information* dialog box opens.

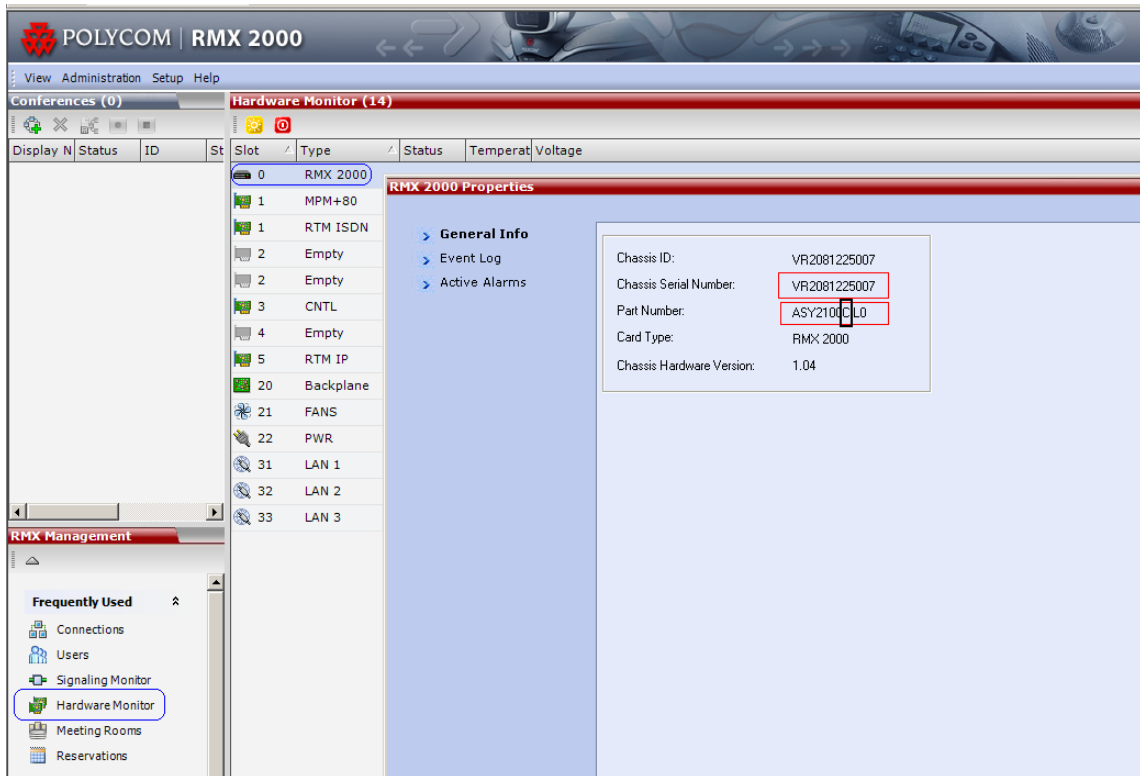

The RMX Part Number contains the letter A/B/C/D that represents the chassis type, as shown in the capture above.

For more details, see the RMX Administrator's Guide, Chapter 19, "RMX Hardware Monitoring" .

## Component Replacement

The RMX 2000 is designed with ease of maintenance in mind. Most components are swappable and are accessible directly via the front panel or the rear panel.



Only MPM/MPM+/MPMx cards are Hot Swappable. The RTM IP and RTM ISDN card are not Hot Swappable. System shutdown is required when replacing the RTM ISDN or RTM IP card.

The following components can be replaced when they are faulty:

- CNTL Module, see "*Replacing the CNTL Module*" on page **1-31**.
- Power Supply Module, see "*Replacing the Power Supply Module*" on page **1-33**.
- Fan drawer, see "*Replacing the Fan Drawer*" on page **1-34**.
- MPM/MPM+/MPMx card. This card is hot-swap enabled. See "*Replacing a Faulty MPM/MPM+/MPMx Card*" on page **1-35**.
- RTM ISDN card, see "*Replacing a RTM ISDN Card*" on page **1-37**.
- RTM IP card, see "*Replacing a RTM ISDN Card*" on page **1-37**.



### Warning!

- All maintenance tasks are to be performed by qualified, authorized personnel.
- Use only replacement parts supplied by your dealer.
- Follow all procedures. Do not skip any steps.

Before replacing parts:

- To ensure a part needs replacing, complete the troubleshooting procedures.
- Identify exactly which part needs replacing.
- Make sure you have the correct replacement part on hand.
- Make sure you are using proper ESD equipment, to prevent damage to the system.



### Note!

On all cards, if during the startup phase the blue HS LED remains lit, please make sure that the card is properly seated in its slot. If this problem persists, contact your next level of support.

## Types of Ejector Levers on RMX Components

On the RMX, 2 types of ejector levers can be attached to the cards:

- An all metal (silver) lever
- A modified PMC compatible ejector lever covered by plastic caps with a lock catch

### Using the All Metal Ejector Lever

This ejector lever can be moved to 3 positions:

- **Closed** - The ejector levers are fully retracted and pushed up against the card's panel
- **Partially Open** - For card powering down mode. Partially open the ejector lever(s) until the blue *HS* LEDs on the card and the *Control Unit* start flashing. When the HS LED is constantly lit the card is in a powered down mode and you can remove the card.



#### Warning!

Once the removal sequence is initiated and the HS led flashes, the process cannot be terminated when activated.

- **Fully Open** - The card is released from the MCU housing

### Using the Modified PMC Compatible Ejector Lever

This ejector lever can be moved to 3 positions:

- **Closed/Locked** - Ejector lever(s) are gently pushed up against the card's panel and is locked. Ensure that the lock catch is in the standard closed position (shifted to the right as shown below).

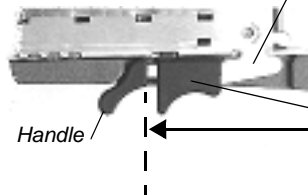

**Closing the Lever** - Make sure that the lever is in an open position and push card close to the chassis till the lever engages. With your index finger holding the "handle" and your thumb holding the catch fully to left, push the card against the chassis whilst closing the lever. Use your thumb to push the card into place by pushing your thumb to the right and locking the catch into a locked position. Make sure that the lever is locked.

**Unlocking the Lock Catch** - With your index finger holding the "handle" and your thumb shifting the catch to left, gently pull the handle away from the chassis until the lever is "fully open"

- **Partially Open** - For card powering down mode. Partially open the ejector lever(s) until the blue *HS* LEDs on the card and the *Control Unit* start flashing. When the HS LED is constantly lit the card is in a powered down mode and you can remove the card.



**Warning!**

Once the removal sequence is initiated the process cannot be terminated and the HS led flashes when activated.

- **Fully Open** - In this position the card is released from the MCU housing and can be removed.

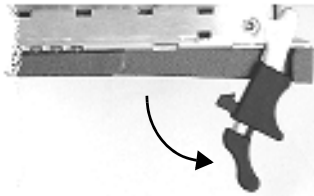

**Lever Fully Open** - Pull the lever handle(s) to a fully open position (approx. 70 degrees), as shown here

## Replacing the CNTL Module

The CPU module is the management system of the RMX 2000. Use the following procedure to replace a CNTL Module:

- 1 Ensure that power switch on the RMX 2000 is turned OFF (O).
- 2 Unscrew the captive screws on the front panel of the RMX 2000 that secure the CNTL Module.
- 3 Use the metal ejector levers to pull the CNTL Module out of its slot in the Backplane.
- 4 Carefully slide the CNTL Module out through the front panel.

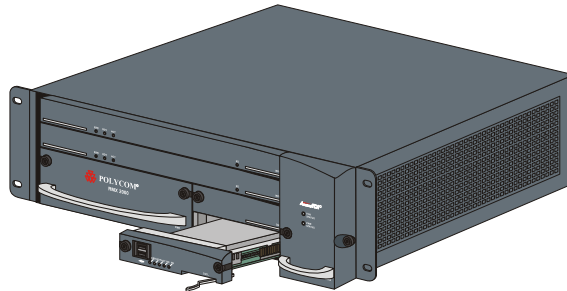

- 5** On the CNTL Module to be installed, move the ejector lever to the fully open position.
- 6** Slide in the replacement CNTL Module.
- 7** Push the CNTL Module firmly into the Backplane, making sure it is properly seated in its slot.
- 8** Ensure that the metal ejector levers are fully retracted into their housings.
- 9** Tighten the captive screws on the front panel of the RMX 2000 that secure the Functional CNTL Module.
- 10** Turn ON the RMX 2000.



For more information on the *Card Configuration Modes* after reset, see "*MPM/MPM+ and MPMx Media Cards*" on page **1-16**.

## Replacing the Power Supply Module

A single supply unit powers the RMX 2000. Use the following procedure to replace a Power Supply:



Please verify the type of power supply used on your RMX 2000. Do not insert a different type of power supply than the current type installed on your system.

- 1 Ensure that the power switch on the RMX 2000 is turned OFF (O) and that the power cords are disconnected from the MCU.
- 2 Unscrew the captive screws on the front panel of the RMX 2000 that secure the Power Supply unit.
- 3 Use the finger grip to pull the Power Supply unit out of its slot in the Backplane.
- 4 Carefully slide the Power Supply unit out through the front panel.

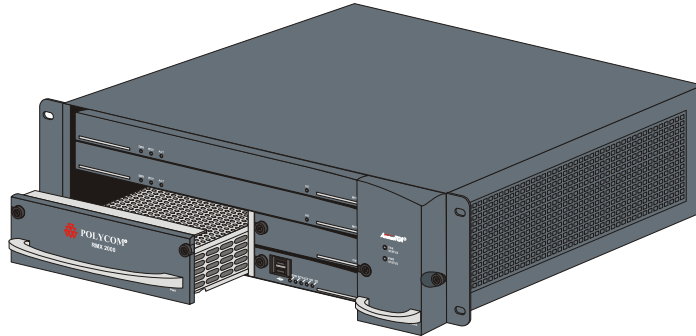

- 5 Slide in the replacement Power Supply unit.
- 6 Push the Power Supply unit firmly into the Backplane, making sure it is properly seated in its slot.
- 7 Ensure that the metal ejector levers are fully retracted into their housings.
- 8 Tighten the captive screws on the front panel of the RMX 2000 that secure the Power Supply unit.
- 9 Turn ON the RMX 2000.



For more information on the *Card Configuration Modes* after reset, see "*MPM/MPM+ and MPMx Media Cards*" on page **1-16**.

## Replacing the Fan Drawer

Three fans are mounted in the Fan drawer, where the airflow is from right to left. Should one of these fans fail as indicated by a Fan LED, you are required to replace the Fan drawer.

- 1 Unscrew the captive screws on the front panel of the RMX 2000 that secure the Fan drawer.
- 2 Use the metal ejector levers to pull the Fan drawer out of its slot in the Backplane.
- 3 Carefully slide the Fan drawer out through the front panel.



### Warning!

The Fan drawer can be replaced when the RMX unit is ON, however a replacement drawer must be inserted immediately. The temperature increase is detected by the system, when critical, a system shutdown is initiated.

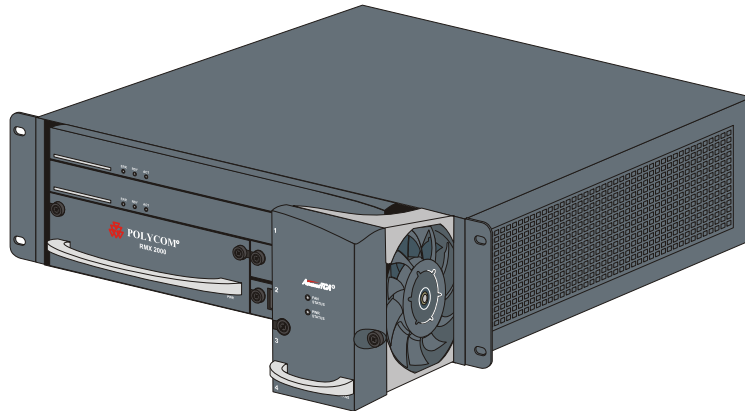

- 4 Slide in the replacement Fan drawer.
- 5 Push the Fan drawer firmly into the Backplane, making sure it is properly seated in its slot.
- 6 Ensure that the metal ejector levers are fully retracted into their housings.
- 7 Tighten the captive screws on the front panel of the RMX 2000 that secure the Fan drawer.



## Replacing a Faulty MPM/MPM+/MPMx Card

### Removing the MPM/MPM+/MPMx Card from the MCU

All MPM/MPM+/MPMx cards can be installed or removed while the RMX 2000 is powered on and operating.

Prior to removing an MPM/MPM+/MPMx card the captive screws must be unscrewed and the ejector levers must be opened to initiate a “power down” on the card.

- 1 If applicable, loosen the captive screws and remove the slot cover.
- 2 Power down the card by partially opening the ejector levers until the blue *HS* LED on the card and the *Control Unit* start to flash.



#### Warning!

Once the removal sequence is initiated the process cannot be terminated and the *HS* LED flashes.

- 3 The power off sequence for the interconnected MPM/MPM+/MPMx and RTM ISDN cards are initiated as follows:
  - All participant connections on the card are disconnected.
  - A fault is generated on the system.
  - For each disconnected participant, a participant disconnection event is written to the CDR with the disconnection cause *Disconnected by Operator*.
  - New participant connections are blocked when the card is removed.
  - If an RTM ISDN card is connected to the MPM/MPM+/MPMx card it is also powered off and all ISDN and PSTN participants are disconnected.
  - When an RTM ISDN card is removed, its resources are deducted from the Resource Report.
  - A *Log File* entry is written indicating MPM/MPM+/MPMx card removal.
  - Port usage is re-calculated and the *Port Gauges* and *Video/Voice Port Configuration* dialog box are updated.
- 4 When the blue *HS* LEDs on the MPM/MPM+/MPMx, RTM ISDN and Control Unit stop flashing and remain lit, unscrew the captive screws and move the ejector levers to their fully open position and remove the MPM/MPM+ card.

- 5 Carefully slide the MPM/MPM+/MPMx card out through the front panel.

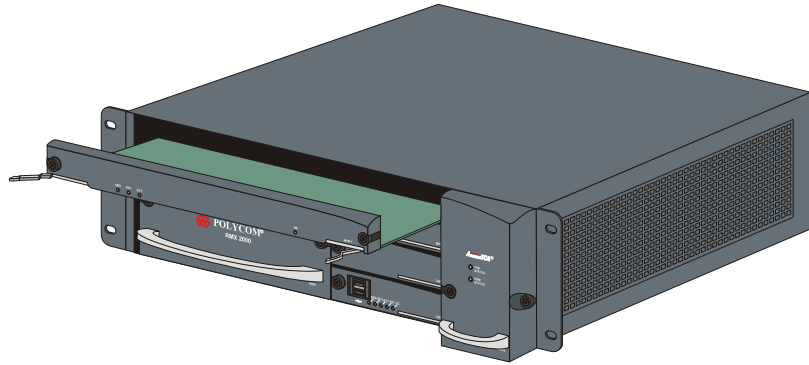

### **Installing the Replacement MPM/MPM+/MPMx Card**

- 1 On the card to be installed, move the ejector levers to their fully open position.
- 2 Slide in the replacement MPM/MPM+/MPMx card.
- 3 Push the MPM/MPM+/MPMx card firmly into the Backplane, making sure it is properly seated in its slot.
- 4 Ensure that the metal ejector levers are fully retracted into their housings.
- 5 Tighten the captive screws on the front panel of the RMX that secure the MPM/MPM+/MPMx card to the chassis.

### **Installing a New MPM/MPM+/MPMx Card in a Powered On RMX 2000**

- 1 If applicable, loosen the captive screws and remove the slot cover.
- 2 On the card to be installed, move the ejector levers to their full open position.
- 3 Insert the card into the slot until the ejector levers touch the front edge of the card cage.
- 4 Push the ejector levers to their closed position and tighten the captive screws on each side of the card, securing the MPM/MPM+/MPMx card to the RMX.

The blue HS LEDs on the MPM/MPM+/MPMx card and the *Control Unit* start flashing and the power on cycle for the card is initiated:

- The card's resources are added to the system resources list
- The number of available ports on the RMX is increased to the current CFS license level
- Port usage is re-calculated and the *Port Gauges* and *Video/Voice Port Configuration* are updated

When the power on cycle of the MPM/MPM+/MPMx card is completed, the blue HS LEDs will turn OFF. The green RDY LED on the MPM/MPM+/MPMx card switches on and remains lit.

## Replacing a RTM ISDN Card



The RTM ISDN card can only be used with software version 3.0 or higher.

- 1 Ensure that the power switch on the RMX 2000 is turned OFF (O).
- 2 Loosen the captive screws that fasten the card to the MCU.
- 3 Remove the RTM ISDN card. Use the metal ejector levers to pull the RTM ISDN card out of its slot in the backplane.
- 4 Carefully slide the RTM ISDN card out through the front panel.
- 5 On the card to be installed, move the ejector levers to their fully open position.

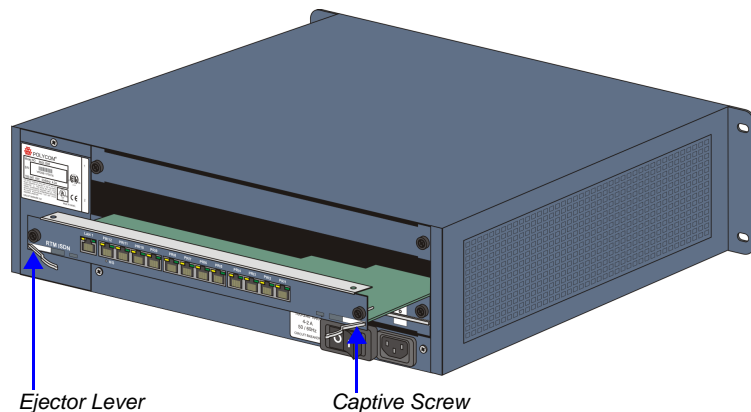

- 6 Slide in the replacement RTM ISDN card.
- 7 Insert the card into the slot until the ejector levers touch the front edge of the card cage.
- 8 Push the ejector levers to their fully closed position.
- 9 Tighten the captive screws on each side of the rear panel of the card, securing the RTM ISDN card to RMX.
- 10 Turn ON the RMX 2000.
- 11 Connect the RJ-45 terminated PRI cables into any of the slots labeled PRI1 - PRI12:

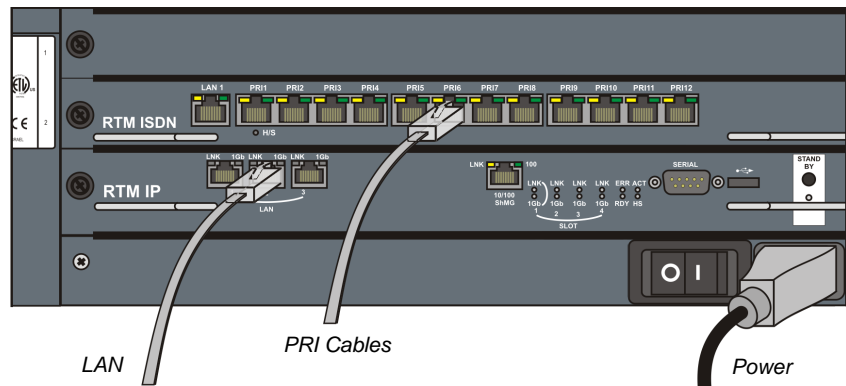

7 E1 or 9 T1 cables can be connected to each RTM ISDN card, up to a total of 14 E1 or 18 T1 PRI cables when two RTM ISDN cards are installed.

## Replacing the RTM IP Card

The RTM IP card on the rear of the RMX 2000 provides connectivity to all the MCU modules. Use the following procedure to replace the RTM IP card:

- 1** Ensure that the power switch on the RMX 2000 is turned OFF (O).
- 2** Unscrew the captive screws on the rear panel of the RMX 2000 that secure the RTM IP card.
- 3** Use the metal ejector levers to pull the RTM IP card out of its slot in the backplane.

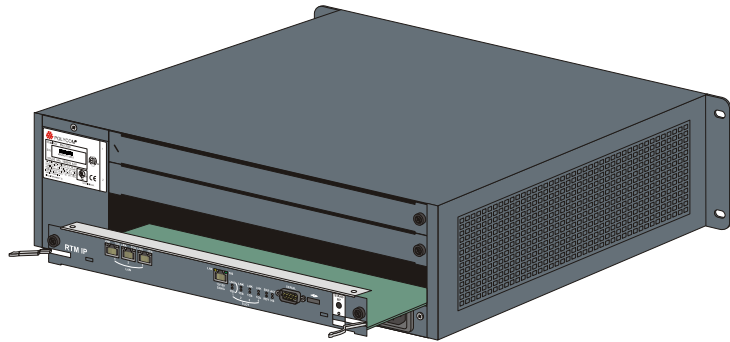

- 4** Carefully slide the RTM IP card out through the rear panel.
- 5** On the card to be installed, move the ejector levers to their fully open position.
- 6** Slide in the replacement RTM IP card.
- 7** Push the RTM IP card firmly into the backplane, making sure it is properly seated in its slots.
- 8** Ensure that the metal ejector levers are fully retracted into their housings.
- 9** Tighten the captive screws on the rear panel of the RMX 2000 that secure the RTM IP card.
- 10** Turn ON the RMX 2000.



For more information on the *Card Configuration Modes* after reset, see "*MPM/MPM+ and MPMx Media Cards*" on page **1-16**.