

Sunbeam

Gelateria[®]

Automatic Ice-Cream Maker

Instruction Booklet
GL8200

Please read these instructions carefully
and retain for future reference.



Contents

Sunbeam's Safety Precautions	1
Features of your Gelateria	2
Before using your Gelateria	5
Using your Gelateria	6
Handy Hints	9
Tips to making custard based ice-cream	10
Care and Cleaning	11
Recipes	12

Important instructions – retain for future use.

تأكد من تفهم احتياطات السلامة المذكورة اعلاه

請務必理解上述的安全預防措施。

Assurez-vous que les précautions ci-dessus relatives à la sécurité sont bien comprises

Versichern Sie sich daß die obenstehenden Sicherheitsmaßnahmen Verstanden werden

Βεβαιώνετε πως οι παραπάνω προφυλάξεις ασφαλείας γίνονται κατανοητές

Pastikan bahwa tindakan-tindakan keselamatan seperti di atas dimengerti anda

Accertatevi che le suddette norme di sicurezza siano comprese a dovere

上記の注意事項をよくお読みになり、安全を御確認ください

Уверете се дека погоре споменатите мерки на претпазливост се добро разбрани

Asegúrese de que las precauciones de seguridad precedentes sean bien comprendidas

کاری بکنید کہ احتیاطهای بالا حتماً درک بشوند

ต้องแน่ใจว่า ข้อควรระวังเรื่องความปลอดภัยข้างต้น เป็นที่เข้าใจกันดี

Yukarda belirtilen güvenlik önlemlerinin anlaşıldığından emin olunuz

Xin kiểm chắc rằng những biện pháp làm an toàn kể trên được hiểu rõ

Sunbeam's Safety Precautions

SAFETY PRECAUTIONS FOR YOUR SUNBEAM GELATERIA, AUTOMATIC ICE-CREAM MAKER.

- Do not immerse the paddle motor in water or any other liquid.

- Always operate on a flat surface.
- Always store the Ice-Cream Maker in an upright position.
- Ensure that the ventilation slots on either side of the appliance are not obstructed.

Sunbeam is very safety conscious when designing and manufacturing consumer products, but it is essential that the product user also exercise care when using an electrical appliance. Listed below are precautions which are essential for the safe use of an electrical appliance:

- Read carefully and save all the instructions provided with an appliance.
- Always turn the power off at the power outlet before you insert or remove a plug. Remove by grasping the plug - do not pull on the cord.
- Turn the power off and remove the plug when the appliance is not in use and before cleaning.
- Do not use your appliance with an extension cord unless this cord has been checked and tested by a qualified technician or service person.
- Always use your appliance from a power outlet of the voltage (A.C. only) marked on the appliance.
- This appliance is not intended for use by persons (including children) with reduced physical, sensory or mental capabilities, or lack of experience and knowledge, unless they have been given supervision or instruction concerning use of the appliance by a person responsible for their safety.
- Children should be supervised to ensure that they do not play with the appliance.
- The temperature of accessible surfaces may be high when the appliance is operating.
- Never leave an appliance unattended while in use.
- Do not use an appliance for any purpose other than its intended use.
- Do not place an appliance on or near a hot gas flame, electric element or on a heated oven.
- Do not place on top of any other appliance.
- Do not let the power cord of an appliance hang over the edge of a table or bench top or touch any hot surface.
- Do not operate any electrical appliance with a damaged cord or after the appliance has been damaged in any manner. If damage is suspected, return the appliance to the nearest Sunbeam Appointed Service Centre for examination, repair or adjustment.
- For additional protection, Sunbeam recommend the use of a residual current device (RCD) with a tripping current not exceeding 30mA in the electrical circuit supplying power to your appliances.
- Do not immerse the appliance in water or any other liquid unless recommended.
- Appliances are not intended to be operated by means of an external timer or separate remote control system.
- This appliance is intended to be used in household and similar applications such as: staff kitchen areas in shops, offices and other working environments; farm houses; by clients in hotels, motels and other residential type environments; bed and breakfast type environments.

If you have any concerns regarding the performance and use of your appliance, please visit www.sunbeam.com.au or contact the Sunbeam Consumer Service Line. Ensure the above safety precautions are understood.

Features of your Gelateria

Transparent lid with pouring hole

Enables easy pouring of ingredients during the mixing process and its transparency allows observation of the ice-cream making process.

Removable cylinder

This 1 Litre metal cylinder with carry handle is easily removed from the appliance for the serving of frozen desserts and a quick clean up.

Paddle

The specially designed paddle guarantees perfect aeration throughout the ice-cream mixture, ensuring a deliciously creamy result every time.

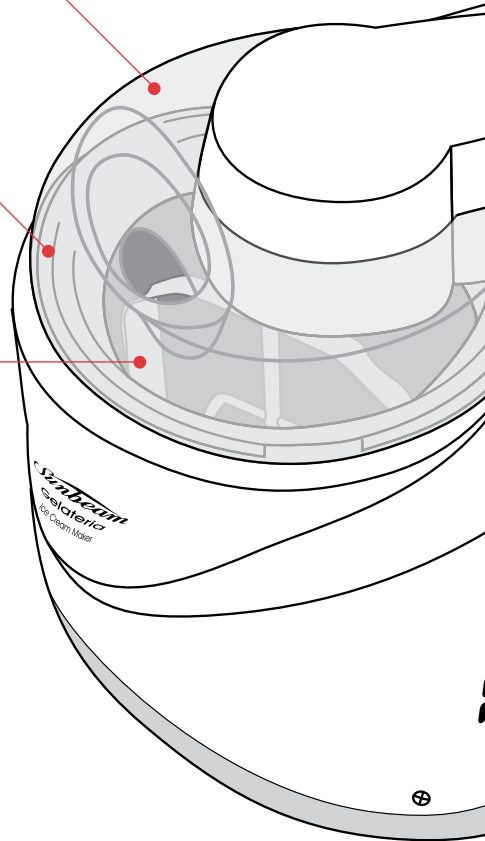

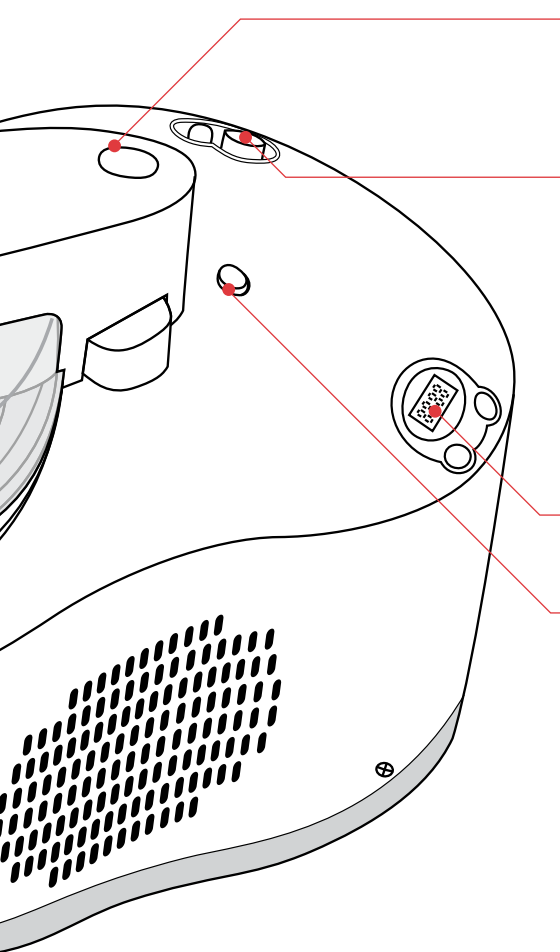

Paddle motor On/Off

Will start the churning of mixture inside the cylinder, when used in conjunction with the LED timer.

Chiller On/Off

The appliance is pre-chilled for 5 minutes to ensure freezing temperatures as low as -30°C are reached during the churning process. This is possible due to an internal compressor which creates the perfect freezing environment to make frozen desserts at a moments notice, eliminating the need to pre-freeze canisters overnight. The indicator light shows that the chilling system is operating.

LED timer display

Release button

Pressing the Release button enables the paddle motor with transparent lid to be removed from the appliance.

Features of your Gelateria (continued)

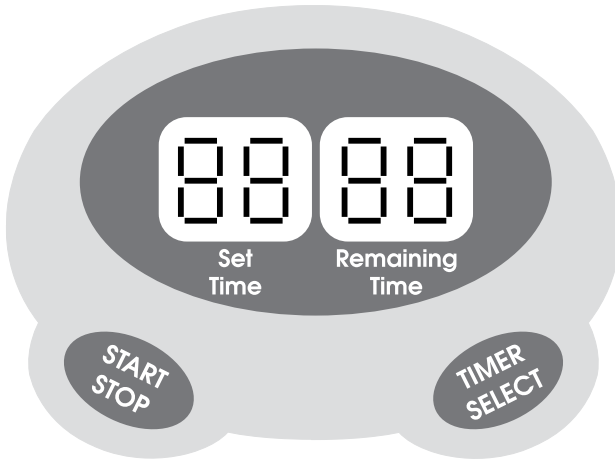

LED timer display

Set time - The preselected time for churning a mixture is displayed on the left side of the panel in red and remains constant throughout the churning process. This set time can be increased with increments of 5 minutes until a maximum of 60 minutes is reached. In the event that additional time is required above 60 minutes, the appliance will reset to 5 minutes. Set time will flash to indicate that the timer has not yet started.

Remaining time - the remaining time for churning a mixture is displayed on the right side of the panel in green and will decline by 1 minute. When **02** minutes is reached, the timer will flash and beep for 5 counts, indicating that the churning will finish in 2 minutes. When the timer has reached the set churning time, the remaining time will display **00** and the timer will beep for 18 counts.

Start/Stop - Pressing the Start button will commence the timer and rotation of the paddle. Alternatively, whilst the appliance is operating, pressing the Stop button will stop the timer as well as the paddle. Additionally, pressing the Stop button will cancel the beeping notice of the timer, if desired.

Timer Select - Allows you to select the time necessary to make a particular frozen dessert, with 5 minute increments up to 60 minutes. When this time is reached, the paddle motor will switch off automatically and beep for 18 counts.

Before using your Gelateria

Important: Place the Gelateria upright on a flat surface for at least 12 hours before using it for the first time, to allow the oil contained in the compressor to settle. The same procedure should be followed in the event that the ice-cream maker has been accidentally placed in a non-upright position.

1. Before use, thoroughly wash all parts that will come into contact with the ice-cream. The fixed stainless steel cylinder should be cleaned using a damp cloth and dried thoroughly. The removable cylinder, transparent lid with pouring hole and paddle should be washed in warm soapy water, rinsed and dried thoroughly.

2. When your Ice-Cream Maker is first used, you may experience an odour and possibly a slight wisp of smoke from the appliance. This is released by the insulation material of the motor when the appliance is heated, which protects the motor and is a normal occurrence. After the first few uses, this will no longer occur.

Using your Gelateria

1. Position the Ice-Cream Maker on a dry, level surface, ensuring that the ventilation slots on either side of the appliance are not obstructed.
2. Ensure your Ice-Cream Maker is unplugged from the power outlet before fitting the connecting parts.
3. Pour a solution of salt and water into the fixed stainless steel cylinder, using 1 tablespoon (20ml) water and a teaspoon (5g) salt.

NOTE: The salt solution is recommended in order to facilitate the transfer of freezing temperatures from the fixed cylinder to the removable cylinder and guarantee the success of the frozen dessert.

4. Insert the removable cylinder inside the fixed stainless steel cylinder. Be sure to position the handle of the removable cylinder in between the locking tab to prevent the cylinder from moving during the churning process. See figure 1.

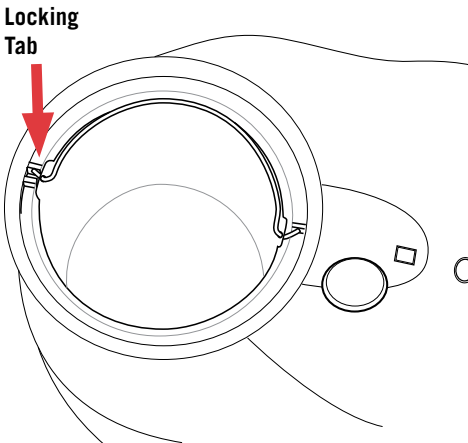

Figure 1

5. Attach the transparent lid with pouring hole to the base of the paddle motor, using the round cutout in the centre of both parts to align correctly. Connect these two parts together by rotating the plastic screw in an anti-clockwise direction until firm. See figure 2.

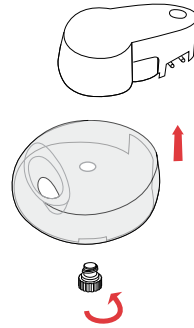

Figure 2

6. Insert the paddle into the opening at the base of the paddle motor. See figure 3.

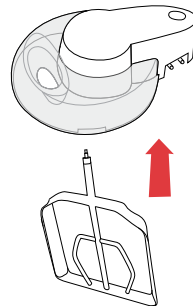

Figure 3

7. Position the paddle motor with paddle over the cylinder and rotate clockwise until the connection plug of the paddle motor locks into the adjacent socket. See figure 4.

Using your Gelateria (continued)

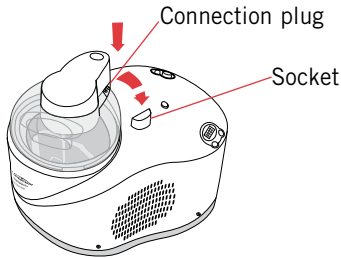

Figure 4

8. Plug the power cord into a 230-240 volt power outlet and turn the power on.
9. Turn the chill switch on. The indicator light shows that the chilling system is operating. Wait 5 minutes to allow the appliance to chill.

NOTE: The LED timer can be used to time 5 minutes. Ensure the paddle motor button is not depressed.

IMPORTANT: Do not turn off the chill switch until after the ice-cream is ready. If the switch is turned off, the chilling process automatically ceases, jeopardising the success of the ice-cream. When the chill switch is turned on again, there will be a 5 minute delay before the chilling process will recommence.

10. Select the necessary time required to make the frozen dessert by pressing the 'Timer Select' button featured on the lower right hand corner, of the LED timer display. The ice-cream making process generally takes between 25-55 minutes. The left side of the LED panel will display the preselected 'Set Time' and will flash continuously until the timer is turned on. The timer can be set for a maximum of 60 minutes using 5 minute increments.

NOTE: When the power is turned on, both the Set Time and Remaining Time display 5 minutes.

11. Turn the paddle motor on.
12. Press Start on the LED control panel.
13. Pour the prepared frozen dessert mixture through the pouring hole, into the cylinder.

NOTE: Do not place hot liquids into the cylinder. All ingredients should be at refrigerator temperatures.

14. To add ingredients such as chocolate chips and raisins, after the mixing process has begun, gently add them through the pouring hole on the transparent lid.

NOTE: Alcohol inhibits the freezing process. If adding alcohol to a recipe, add when the mixture is almost frozen. The LED timer is programmed to beep 5 times, 2 minutes before the unit is switched off. This is the ideal time to add alcohol to frozen dessert mixtures.

15. When the preselected time has been reached, the timer will beep consecutively for 18 counts and the paddle motor will switch off automatically. This beeping notice can be cancelled by pressing the 'Stop' button located on the lower left hand corner of the LED control panel.

NOTE 1: If at any time during the churning process, the set time is insufficient to achieve the right consistency for a frozen dessert, the timer can be increased accordingly. There is no need to stop the timer.

NOTE 2: If the ice-cream has reached a good consistency, the paddle rotation reverses direction, indicating that the ice-cream is ready. Should this occur prior to reaching the set time on the LED timer display, the paddle motor should be turned off and the timer stopped.

Using your Gelateria (continued)

16. Turn the paddle motor off.

17. Turn the chill switch off.

NOTE: If you require slightly denser ice-cream, leave the chill switch on for a further 5 to 10 minutes. After 10 minutes, the chill switch should be turned off and the ice-cream transferred to an airtight container and placed into the freezer. Leaving the ice-cream in the cylinder for longer than 10 minutes will make it difficult to remove.

18. Lightly press the release button and then remove the paddle motor with transparent lid by rotating anti-clockwise. See figure 5.

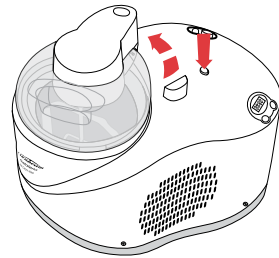

Figure 5

19. Remove the paddle from the mixture.

20. Remove the removable cylinder from the appliance. Only use plastic, wooden or rubber utensils to serve from the removable cylinder. Metal or sharp utensils may damage the removable cylinder.

Handy Hints

- The time taken to make a frozen dessert will depend on the ambient temperature of a room, the appliance and the temperature of the ingredients added to the removable cylinder. As a general rule, the cooler these elements, the faster the frozen dessert making process. The ice-cream making process generally takes between 25-55 minutes.
- When following recipes that require the mixture to be pre-cooked, it is best to prepare the mixture a day in advance. This will allow the mixture sufficient time to cool and expand.
- When preparing dessert mixtures that do not require pre-cooking, always use an electric mixer for maximum aeration.
- Foods such as cream, sugar, eggs and milk are often the key ingredients in any ice-cream mixture. They may be substituted with similar ingredients to suit your taste and dietary requirements. For example, different varieties of cream may be used, which will produce varying flavours and textures.
- Due to an increase in volume during preparation, the maximum amount of liquid mixture should not exceed 850ml. However, sorbets do not expand as much therefore can be up to 900ml. If using your own recipes, adapt the volume of mixture to these amounts. This 850ml will create approximately 1 Litre.
- Alcohol inhibits the freezing process. If adding alcohol to a recipe, add when the mixture is almost frozen. The best way to judge this, is when the mixture reaches the top of the cylinder.
- The flavour of a sorbet will depend greatly on the ripeness and sweetness of the fruit and/ or juice. If a fruit is too tart, add a little extra sugar in the sugar syrup: if the fruit is very ripe, decrease the sugar in the sugar syrup a little. Remember that once frozen, your recipe will not be quite as sweet as the original mixture.
- The consistency of the ice-cream/sorbets will be a spoonable consistency when finished. We recommend however placing mixture in the freezer for a further 2 hours before serving if using ice-cream cones.
- Artificial sweeteners may be used as a substitute for sugar, but must be added to cool or room temperature mixtures. If the recipe calls for sugar to be dissolved over heat and you wish to use an artificial sweetener, then you should omit this process. Simply stir the sweetener into the cool mixture until dissolved.
- We recommend that you should use an artificial sweetener that is in equal proportion to sugar.
- When storing your frozen dessert, ensure the container is no larger than 1 Litre and well sealed. This will prevent ice crystals forming inside the container.
- Frozen desserts may be stored in the freezer for up to 2 weeks.
- If serving from the freezer, allow the ice-cream to sit out at room temperature for 5-10 minutes; this will make serving easier.

Tips to making custard based ice-cream

A traditional creamy ice-cream is made from a custard base. Here are some steps to help you achieve perfect custard every time.

- Make sure the eggs are fresh and are at room temperature.
- Have your ingredients measured out and ready so that you are not leaving anything waiting.
- Using a wire whisk or electric hand mixer, beat the egg yolks and sugar in a large deep bowl for about 3-4 minutes or until light and creamy. The colour will go quite light.
- Place the milk/cream required for the recipe in a saucepan.
- Heat the milk mixture on a low/medium heat until the mixture looks like it is almost about to boil. A good guide is when little bubbles start to appear around the edges of the milk. Be careful not to boil. Should you boil the milk you will need to start again.
- Using a wire whisk, whisk the hot milk mixture gradually into the egg mixture making sure that the two are well combined.
- Return the mixture into a clean saucepan and cook over a low heat, stirring constantly with a wooden spoon. The custard mixture is ready when it thickens and coats the back of a spoon. To test this place the wooden spoon into the custard mixture then turn the spoon over. Run your finger once down the back of the spoon. If the custard is thick enough it will keep the finger mark, if it is still runny the mixture will either not grab onto the back of the spoon and look very thin or the finger mark will not stay.
- If the mixture separates or curdles then heat is too high.
- Do not leave the custard unattended while cooking.
- The custard will take anywhere from 5-15 minutes to thicken depending on the type/size of saucepan used. It is best to use a low heat as different stove types will vary greatly in heat.
- Once the custard has thickened, transfer the mixture into a heat proof bowl. Allow the mixture to cool before placing into the refrigerator, cover and chill for several hours before use.

Care and Cleaning

- Always turn the power off and remove the plug from the power outlet after use and before cleaning.
- Transparent lid with pouring hole and paddle may be placed on the top shelf of the dishwasher. Plastic screw may be placed in the cutlery tray of the dishwasher.
- The removable aluminium cylinder should be washed in warm soapy water, rinsed well and dried thoroughly.
- The fixed stainless steel cylinder should be cleaned using a damp cloth to remove the salt water solution and then dried thoroughly.
- The paddle motor and surface of the appliance can be cleaned by using a damp cloth.
- Do not use sharp objects or metal utensils inside the removable cylinder. Sharp objects will scratch and damage the inside of the removable cylinder. A plastic, wooden or rubber spoon, or spatula, may be used when the appliance is in the 'OFF' position.
- Never immerse the appliance, including the paddle motor, in water.

Recipes

Basic Vanilla Ice-cream 1

Makes 1 litre

- 1 cup (250ml) milk
- 2 cups (500ml) thickened cream
- 1 vanilla bean, seeds scraped*
- 5 egg yolks
- ½ cup (110g) caster sugar

1. Combine milk and cream in a saucepan. Split vanilla bean in half lengthways. Scrape out the seeds; add the pod and the seeds to the saucepan. Bring the mixture to simmering point over low heat.
2. Whisk egg yolks and sugar together for 3-4 minutes, until light and creamy.
3. Gradually whisk in hot milk mixture into yolk mixture until well combined.
4. Return the mixture into a clean saucepan and cook, stirring constantly with a wooden spoon, over low heat until mixture thickens and coats the back of the spoon.
5. Transfer mixture to a bowl and remove vanilla pod. Allow to cool before placing in the fridge to chill for several hours.
6. Position the Automatic Ice-cream Maker as directed on pages 6-8. Turn unit on; add mixture through the pouring hole.
7. Mixture will be ready once the paddle starts to rotate in the other direction, this will take about 25 minutes.

**Vanilla bean can be substituted with 2 teaspoons of vanilla essence*

Variations to this recipe:

Chocolate Ice-cream

Makes approx. 1 litre

- 1 quantity basic vanilla ice-cream 1
- 150g chopped dark chocolate

1. Follow steps 1-7 for basic vanilla ice-cream 1, heating the dark chocolate with the cream and milk.
2. Omit vanilla bean.

Rum & Raisin Ice-cream

Makes approx. 1 litre

- 1 quantity basic vanilla ice-cream 1
- ⅓ cup (55g) chopped raisins
- 2 tablespoons rum

1. Follow steps 1-7 for basic vanilla ice-cream 1. Omit vanilla bean.
2. Soak ⅓ cup (55g) chopped raisins with 2 tablespoons of rum for 1 hour.
3. At 2 minute timer check to see if mixture is almost at the top of the cylinder. This should take about 25 minutes. If so add the raisins and rum or if not increase timer for a little longer. The raisins and rum should only be added once the mixture has almost come to the top of the cylinder.

NOTE: Because of the addition of alcohol in this mixture, it may not force the paddle to rotate in the opposite direction; the best way to judge if this recipe is ready is when the mixture comes up to the top of the bowl.

Recipes (continued)

Variations to basic vanilla ice-cream 1 continued:

White Chocolate Ice-cream

Makes approx. 1 litre

1 quantity basic vanilla ice-cream 1
150g chopped white chocolate
50g finely chopped white chocolate, extra

1. Follow steps 1-7 for basic vanilla ice-cream 1, on page 12. Heat the white chocolate with the cream and milk. Omit vanilla bean.
2. Add finely chopped chocolate to the custard mixture through the pouring hole when churning.

Peppermint Choc Chip Ice-cream

1 quantity basic vanilla ice-cream 1
1-2 teaspoons peppermint essence
 $\frac{1}{3}$ cup finely chopped dark chocolate
green food colouring (optional)

1. Follow steps 1-7 for basic vanilla ice-cream 1, on page 12. Omit vanilla bean.
2. Add peppermint essence to mixture before churning.
3. Add finely chopped chocolate and food colouring to the custard mixture through the pouring hole when churning.

Basic Vanilla Ice-cream 2 Makes approx.800ml

1 cup (250ml) milk
1 cup (250ml) thickened cream
1 Vanilla Bean*
4 egg yolks
 $\frac{1}{2}$ cup (110g) caster sugar

1. Combine milk and cream in a saucepan. Split vanilla bean in half lengthways. Scrape out the seeds and add the pod and the seeds to the saucepan. Bring the mixture to simmering point over low heat.
2. Whisk egg yolks and sugar together for 3-4 minutes, until light and creamy.
3. Gradually whisk in hot milk mixture into yolk mixture until well combined.
4. Return the mixture into a clean saucepan and cook, stirring constantly with a wooden spoon, over low heat until mixture thickens and coats the back of the spoon. Do not allow mixture to boil or it will curdle.
5. Transfer mixture to a bowl and remove vanilla pod. Allow to cool before placing in the fridge to chill for several hours.
6. Position the Automatic Ice-Cream Maker as directed on pages 6-8. Turn unit on; add mixture through the pouring hole.
7. Mixture will be ready once the paddle starts to rotate in the other direction, this will take about 25 minutes.

**Vanilla bean can be substituted with 2 teaspoons of vanilla essence*

Recipes (continued)

Variations to basic vanilla ice-cream 2:

Coffee Ice-cream **Makes 850ml**

1 quantity basic vanilla ice-cream 2
60ml strong fresh espresso

1. Follow steps 1-7 for basic vanilla ice-cream 2, on page 13. Heating the coffee with the cream and milk.
2. Omit vanilla bean.

Mango Ice-cream **Makes approx. 1 litre**

1 quantity basic vanilla ice-cream 2
300g fresh or frozen mango flesh, pureed

1. Follow steps 1-7 for basic vanilla ice-cream 2, on page 13. Omit vanilla bean.
2. Once custard is cold, stir through mango puree and chill until ready to churn.

Strawberry Ice-cream **Makes approx. 1 litre**

1 quantity basic vanilla ice-cream 2
500g strawberries, hulled
¼ cup (55g) caster sugar

1. Follow steps 1-7 for basic vanilla ice-cream 2, on page 13. Add strawberry mixture in step 6. Omit vanilla bean.
2. To make strawberry mixture process strawberries in a food processor until smooth. Press mixture through a fine sieve; discard seeds.
3. Place strawberry puree and extra sugar in a saucepan and stir over a low heat until the sugar has dissolved. Increase heat and boil, stirring occasionally, for about 8 minutes or until the mixture has reduced to 1 cup. Transfer to a heatproof bowl or jug; chill for several hours.
4. Once custard is cold; stir through strawberry mixture and chill until ready to churn.

Choc Hazelnut Ice-cream **Makes approx. 900ml**

1 quantity basic vanilla ice-cream 2
¼ cup chocolate hazelnut spread
4 Ferrero Rocher Chocolates

1. Follow steps 1-7 for basic vanilla ice-cream 2, on page 13. Heat the hazelnut spread with the cream and milk. Omit vanilla bean.
2. Place chocolates into a small clean plastic bag and crush with a mallet or rolling pin. Add to the custard mixture through the pouring hole when churning.

Quick Mix

Vanilla Ice-cream **Makes approx. 1 litre**

1½ cups (375 ml) milk
200g condensed milk
¾ cup (180ml) cream
1 teaspoon vanilla essence

1. Combine milk, condensed milk, cream and vanilla essence together in a bowl; mix well.
2. Refrigerate mixture until completely chilled.
3. Position the Automatic Ice-Cream Maker as directed on pages 6-8. Turn unit on; add mixture through the pouring hole.
4. Mixture will be ready once the paddle starts to rotate in the other direction, this will take about 35 minutes.

Recipes (continued)

Variations to quick mix vanilla ice-cream:

Choc-Nut Praline

Ice-cream **Makes approx. 1.25 litres**

- 1 quantity quick mix vanilla ice-cream
- 1 cup (220g) caster sugar
- ½ cup (125ml) water
- ½ cup (100g) dark chocolate, chopped finely
- ¼ cup (35gm) toasted flaked almonds

1. Follow steps 1-4 for quick mix vanilla ice-cream on page 14.
2. Meanwhile, combine sugar and water in a small heavy-based saucepan; stir over low heat until sugar dissolves. Increase heat; boil, uncovered, without stirring, about 10 minutes or until syrup is a deep golden colour.
3. Pour toffee mixture into a 20cm x 20cm square pan; stand 5 minutes. Sprinkle chocolate over hot toffee, spreading with a spatula as chocolate melts, to completely cover toffee. Sprinkle with almonds; refrigerate for approximately 20 minutes or until set. Break choc-nut praline into shards; pulse in a food processor until coarsely chopped.
4. Once the ice-cream is finished stir through 1 cup of the praline mixture; stir to combine. Spoon into a plastic container; cover and freeze until firm.
5. Sprinkle the remaining choc-nut praline on top of ice-cream when serving.

Rocky Road

Ice-cream **Makes approx. 1.2 litres**

- 1 quantity quick mix vanilla ice-cream
- 1 cup (50g) mini marshmallows
- 100g dark chocolate, chopped coarsely
- ¼ cup (20g) shredded coconut, toasted

1. Follow steps 1-4 for quick mix vanilla ice-cream on page 14.
2. Combine marshmallow, chocolate, coconut in a large bowl.
3. Once the ice-cream is finished stir through the marshmallow mixture. Spoon into a plastic container; cover and freeze until firm.

Coconut Ice-cream

Makes approx. 1 litre

- 1 quantity of quick mix vanilla ice-cream, omitting 1 cup of the milk
- 1 cup (250ml) light coconut milk
- 1 tablespoon desiccated coconut

1. Follow steps 1-4 for quick mix vanilla ice-cream, on page 14, reducing the milk to ½ cup (125ml) and replacing with the coconut milk.
2. Add desiccated coconut to the mixture through the pouring hole when churning.

Recipes (continued)

Low Fat Vanilla Ice-cream

- 1½ teaspoons gelatine
- 2 tablespoons boiling water
- 400ml skim milk
- 100ml thickened light cream 18% milk fat
- ¼ cup (55g) caster sugar
- 2 teaspoons vanilla essence

1. Mix gelatine with boiling water and stir until dissolved.
2. Combine milk, cream, sugar and vanilla in a saucepan. Bring the mixture to simmering point over low heat; stirring occasionally until sugar dissolves.
3. Remove from heat and add the gelatine mixture; mix well.
4. Refrigerate until completely chilled.
5. Position the Automatic Ice-Cream Maker as directed on pages 6-8. Turn unit on; add mixture through the pouring hole.
6. Mixture will be ready once the paddle starts to rotate in the other direction, this will take about 30 minutes.

Nutritional information per 100g

397kj; 3.1g total fat; 2g sat fat; 3.9g protein; 13g carbohydrates; 13g sugars

**Makes approx.
750ml (630g)**

Variations to low fat vanilla ice-cream:

Low Fat Chocolate Ice-cream

- 1 quantity low fat vanilla ice-cream
- ¼ cup (30g) cocoa powder
- ¼ cup (55g) caster sugar

1. Follow steps 1-6 for low fat vanilla ice-cream, gently whisking the cocoa powder and sugar into the hot milk until dissolved.

Nutritional information per 100g

560kj; 3.4g total fat; 2.2g sat fat; 4.4g protein; 21g carbohydrates; 20g sugars

Low Fat Strawberry Ice-Cream

- 1 quantity low fat vanilla ice-cream
- 500g strawberries, hulled
- ¼ cup (55g) caster sugar

1. Follow steps 1-6 for low fat vanilla ice-cream adding strawberry mixture in step 5.
2. To make strawberry mixture, process strawberries in a food processor until smooth. Press mixture through a fine sieve; discard seeds.
3. Place strawberry puree and extra sugar in a saucepan and stir over a low heat until the sugar has dissolved. Increase heat and boil, stirring occasionally, for about 8 minutes or until the mixture has reduced to 1 cup. Transfer to a heatproof bowl or jug; chill for several hours.
4. Combine the ice-cream mixture and strawberry mixture in a jug.

Nutritional information per 100g

326kj; 1.7g total fat; 1.1g sat fat; 2.8g protein; 13g carbohydrates; 13g sugars

**Makes approx.
750ml (680g)**

**Makes approx.
1 litre (1180g)**

Recipes (continued)

Reduced Fat Basic Vanilla Ice-cream

**Makes approx
1 litre (1000g)**

This recipe is 40% less fat than our original Basic Vanilla Ice-cream 1 recipe on page 12.

- 1 cup (250ml) skim milk
- 2 cups (500ml) thickened light cream 18% milk fat
- 1 vanilla bean, seeds scraped*
- 5 egg yolks
- ½ cup (110g) caster sugar

1. Combine milk and cream in a saucepan. Split vanilla bean in half lengthways. Scrape out the seeds; add the pod and the seeds to the saucepan. Bring the mixture to simmering point over low heat.
2. Whisk egg yolks and sugar together for 3-4 minutes, until light and creamy.
3. Gradually whisk in hot milk mixture into yolk mixture until well combined.
4. Return the mixture into a clean saucepan and cook, stirring constantly with a wooden spoon, over low heat until mixture thickens and coats the back of the spoon.
5. Transfer mixture to a bowl and remove vanilla pod. Allow to cool before placing in the fridge to chill for several hours.
6. Position the Automatic Ice-cream Maker as directed on pages 6-8. Turn unit on; add mixture through the pouring hole.
7. Mixture will be ready once the paddle starts to rotate in the other direction, this will take about 25 minutes.

**Vanilla bean can be substituted with 2 teaspoons of vanilla essence*

Nutritional information per 100g

787kj; 12.5g total fat; 7.4g sat fat; 4.7g protein; 15g carbohydrates; 15g sugars

Dairy & Egg Free Vanilla Ice-cream

**Makes approx
1 litre (810g)**

This recipe is also low in fat

- 2 teaspoons gelatine
- ¼ cup (60ml) apple juice
- ¼ cup (90g) honey
- 2½ cups (625ml) Vanilla Soy milk or Rice milk
- 2 teaspoons vanilla essence

1. In a small bowl, sprinkle gelatine over apple juice. Stir until gelatine dissolves and softens.
2. Combine honey and milk in a saucepan. Bring the mixture to simmering point over low heat; stirring occasionally until honey dissolves.
3. Remove from heat and add the gelatine mixture & vanilla; mix well.
4. Refrigerate mixture until completely chilled.
5. Position the Automatic Ice-Cream Maker as directed on pages 6-8. Turn unit on; add mixture through the pouring hole.
6. Mixture will be ready once the paddle starts to rotate in the other direction.

Nutritional information per 100g

416kj; 2.5g total fat; 0.2g sat fat; 2.9g protein; 16g carbohydrates; 14g sugars

Recipes (continued)

Vegan Ice-cream **Makes approx 1 litre**

300g firm silken tofu
2 cups (500 ml) Soya milk or Rice milk
1/3 cup maple syrup or brown rice syrup
2 teaspoons vanilla essence

1. Combine all ingredients in a food processor or blender. Process until thoroughly combined and smooth.
2. Refrigerate mixture until completely chilled.
3. Position the Automatic Ice-Cream Maker as directed on pages 6-8. Turn unit on; add mixture through the pouring hole.
4. Mixture will be ready once the paddle starts to rotate in the other direction.

No Added Sugar Ice-cream **Makes approx 1 litre (740g)**

This recipe is also low in fat

1 cup (250 ml) Evaporated Skim milk
1/4 cup sugar replacement
1 1/2 cup (375 ml) skim milk
4 egg yolks
2 teaspoons vanilla essence

1. Combine ingredients in a large mixing bowl and mix well.
2. Refrigerate mixture until completely chilled.
3. Position the Automatic Ice-Cream Maker as directed on pages 6-8. Turn unit on; add mixture through the pouring hole.
4. Mixture will be ready once the paddle starts to rotate in the other direction.

Nutritional information per 100g

328kj; 2.8g total fat; 0.9g sat fat; 6.8g protein; 6.5g carbohydrates; 6.5g sugars

Gelato

There are many different styles of gelato; we have chosen two styles, sugar syrup and custard based. Sugar syrup gelato has a light refreshing taste with a hint of creaminess to them while a custard base gelato has creamier texture but is lighter than ice-cream.

Sugar Syrup **makes 1 1/2 cups**

1 cup (250ml) water
1 cup (220g) caster sugar

1. Place the water and sugar in a small saucepan.
2. Stir over a low heat until the sugar dissolves. Bring to the boil and cook for 2 minutes. Remove from heat. Store in refrigerator.

Green Apple Gelato **makes approx. 750ml**

1 quantity sugar syrup
3 small green apples, juiced
2 tablespoons freshly squeezed lemon juice
2/3 cup (160ml) thickened cream

1. Follow steps 1-2 for sugar syrup, including the apple and lemon juice into the mixture.
2. Strain mixture through a fine sieve. Refrigerate for several hours or overnight.
3. Whisk together the apple syrup and cream in a jug.
4. Position the Automatic Ice-cream Maker as directed on pages 6-8. Turn unit on; add mixture through the pouring hole.
5. Mixture will be ready once the paddle starts to rotate in the other direction or has thickened, this will take about 35 minutes.

Tip: For a slightly greener colour use 1-2 drops of green food colouring.

Recipes (continued)

Green Tea Gelato **Makes approx 700ml**

- 1 quantity sugar syrup
- 2 teaspoons green tea powder
- 1 cup (250ml) thickened cream

1. Follow steps 1-2 for sugar syrup, on page 18. Remove from heat and whisk through green tea powder.
2. Strain mixture through a fine sieve. Refrigerate for several hours or overnight.
3. Whisk together the green tea syrup and cream in a jug.
4. Position the Automatic Ice-cream Maker as directed on pages 6-8. Turn unit on; add mixture through the pouring hole.
5. Mixture will be ready once the paddle starts to rotate in the other direction or has thickened, this will take about 35 minutes.

Tip: Green tea powder is available from Asian food stores

Lemon gelato **Makes approx 750ml**

- 1 quantity sugar syrup
- ¼ cup lemon zest
- ⅔ cup (160ml) freshly squeezed lemon juice
- ⅔ cup (160ml) thickened cream

1. Follow steps 1-2 for sugar syrup, on page 18, including the lemon zest and juice into the mixture.
2. Strain mixture through a fine sieve. Refrigerate for several hours or overnight.
3. Whisk together the lemon syrup and cream in a jug.

4. Position the Automatic Ice-cream Maker as directed on pages 6-8. Turn unit on; add mixture through the pouring hole.
5. Mixture will be ready once the paddle starts to rotate in the other direction or has thickened, this will take about 35 minutes.

Ruby red grapefruit gelato **Makes approx. 750ml**

- 1 quantity sugar syrup
- 1 tablespoon grated ruby red grapefruit zest
- ⅔ cup (160ml) freshly squeezed ruby red grapefruit juice
- ⅔ cup (160ml) thickened cream
- 1-2 drops red food colouring, optional

1. Follow steps 1-2 for sugar syrup, on page 18, including the grapefruit zest and juice into the mixture.
2. Strain mixture through a fine sieve. Refrigerate for several hours or overnight.
3. Whisk together the ruby red grapefruit syrup, cream and red food colouring in a jug.
4. Position the Automatic Ice-cream Maker as directed on pages 6-8. Turn unit on; add mixture through the pouring hole.
5. Mixture will be ready once the paddle starts to rotate in the other direction or has thickened, this will take about 35 minutes.

Recipes (continued)

Custard Based Gelato

Gelato Custard base **Makes approx. 950ml**

2 cups (500ml) milk

½ cup (125ml) light cream

5 egg yolks

½ cup (110g) caster sugar

1. Combine milk and cream in a saucepan. Bring the mixture to simmering point over low heat.
2. Whisk egg yolks and sugar together for 3-4 minutes, until light and creamy.
3. Gradually whisk in hot milk mixture into yolk mixture until well combined.
4. Return the mixture into a clean saucepan and cook, stirring constantly with a wooden spoon, over low heat until mixture thickens and coats the back of the spoon. Do not allow mixture to boil or it will curdle.
5. Transfer mixture to a bowl and remove vanilla pod. Allow to cool before placing in the fridge to chill for several hours.
6. Position the Automatic Ice-Cream Maker as directed on pages 6-8. Turn unit on; add mixture through the pouring hole.
7. Mixture will be ready once the paddle starts to rotate in the other direction, this will take about 25 minutes.

Gelato variations

Chocolate Nougat Gelato **makes approx 1 litre**

1 quantity gelato custard base

80g Toblorone chocolate, chopped

50g chopped Toblorone chocolate, extra

1. Follow steps 1-7 for gelato custard base. Heating the 80g chocolate with the cream and milk.
2. Add finely chopped chocolate to the gelato mixture through the pouring hole when churning.

Passionfruit Gelato **makes approx 1 litre**

You will need approximately 4 passionfruit for this recipe

1 quantity gelato custard base

½ cup passionfruit pulp

1. Follow steps 1-7 for gelato custard base.
2. Stir passionfruit into the gelato mixture before churning.

Pistachio Gelato **makes approx 1 litre**

1 quantity gelato custard base

⅓ cup (50g) roasted and chopped pistachios

1. Follow steps 1-7 for gelato custard base.
2. Add chopped pistachios to the gelato mixture through the pouring hole when churning.

Recipes (continued)

Sorbet

A delicious dairy and fat free dessert which is a perfect way to finish off a meal or enjoy as a treat on a hot day! Sorbets have a sugar syrup base.

Sugar Syrup **makes 1 ½ cups**

1 cup (250ml) water

1 cup (220g) caster sugar

1. Place the water and sugar in a small saucepan.
2. Stir over a low heat until the sugar dissolves. Bring to the boil and cook for 2 minutes. Remove from heat and allow to cool at room temperature before refrigerating for a few hours or until cold.

Mixed Berry Sorbet **Makes approx. 750ml**

500g frozen mixed berries, thawed

1½ tablespoons lime juice

1 quantity sugar syrup

1. Place thawed berries and their juices in a food processor and puree until smooth. Push berries through a sieve to remove the seeds. Chill.
2. Combine the sugar syrup, berries and lime juice and stir to combine.
3. Position the Automatic Ice-cream Maker as directed on pages 6-8. Turn unit on; add mixture through the pouring hole.
4. Mixture will be ready once the paddle starts to rotate in the other direction or has thickened, this will take about 35 minutes.

Watermelon Sorbet **Makes approx 950ml**

You will need 1.2kg watermelon for this recipe

1 quantity sugar syrup

2 cups (500ml) freshly juiced watermelon

¼ cup lemon juice

1. Combine the sugar syrup, watermelon and lemon juice and stir to combine.
2. Position the Automatic Ice-cream Maker as directed on pages 6-8. Turn unit on; add mixture through the pouring hole.
3. Mixture will be ready once the paddle starts to rotate in the other direction or has thickened, this will take about 35 minutes.

Fresh Pineapple and Mint Sorbet **Makes approx 1 litre**

You will need approximately 1 pineapple for this recipe

1 quantity sugar syrup

2 cups (500ml) freshly juiced pineapple juice

1 tablespoon finely shredded mint

1. Combine the sugar syrup, pineapple juice and shredded mint and stir to combine.
2. Position the Automatic Ice-cream Maker as directed on pages 6-8. Turn unit on; add mixture through the pouring hole.
3. Mixture will be ready once the paddle starts to rotate in the other direction or has thickened, this will take about 35 minutes.

Recipes (continued)

Frozen Yogurt

Vanilla Frozen Yogurt **Makes approx 1 litre**

550g vanilla yogurt

260ml milk

135g caster sugar

½ teaspoon vanilla extract

1. Whisk ingredients together in a large jug.
2. Refrigerate for 1 hour or until well chilled.
3. Position the Automatic Ice-cream Maker as directed on pages 6-8. Turn unit on; add mixture through the pouring hole.
4. Mixture will be ready once the paddle starts to rotate in the other direction or has thickened, this will take about 35 minutes.

Mango Swirl Frozen Yogurt

Makes approx 1 litre

400g mango flesh, fresh or frozen

375g low fat vanilla yogurt

175ml low fat milk

90g caster sugar

1. Blend or process mango flesh until smooth. Reserve 150g of the flesh to be swirled through the frozen yogurt at the end.
2. Using an electric mixer, mix the remaining mango with the yogurt, milk and sugar until well combined.
3. Return mix to fridge until well chilled.
4. Position the Automatic Ice-cream Maker as directed on pages 6-8. Turn unit on; add mixture through the pouring hole.
5. Mixture will be ready once the paddle starts to rotate in the other direction or has thickened, this will take about 35 minutes.
6. Turn unit off; remove lid and paddle. Using a spatula gently fold through the remaining mango pulp just enough to give a swirled effect. Carefully spoon mixture into a plastic 1 litre container; freeze until ready to serve.

Notes

Notes

12 Month Repair Guarantee

In the unlikely event that this appliance develops any malfunction within 12 months of purchase due to faulty materials or manufacture, we will REPAIR it for you free of charge.

Should you experience any difficulties with your appliance, please contact our customer service line for advice on 1300 881 861 in Australia, or 0800 786 232 in New Zealand. Alternatively, you can send a written claim to Sunbeam at the address listed below. Upon receipt of your claim, Sunbeam will seek to resolve your difficulties or, if the appliance is defective, advise you on how to arrange for it to be repaired.

Your Sunbeam 12 Month REPAIR Guarantee naturally does not cover misuse or improper handling, and normal wear and tear. Similarly, your 12 Month REPAIR Guarantee does not cover freight or any other costs incurred in making a claim.

It will be at the discretion of Sunbeam whether to repair or replace any appliance that develops a malfunction during the REPAIR Guarantee period. Sunbeam is by no means obliged to replace any appliance if it can be repaired. If the appliance is irreparable due to any claimed defect caused by faulty workmanship or material, then Sunbeam will replace the appliance.

Prior to any repairs being undertaken, a purchase receipt must be provided as proof of purchase. Sunbeam will not be responsible for the cost of transport to and from any Sunbeam authorized service centre, or any insurance costs associated with this transport. Similarly Sunbeam will not be responsible for any damage or loss that occurs during transit to or from any Sunbeam authorized service centre for reasons not related to the malfunction.

The benefits given to you by this guarantee are in addition to your other rights and remedies under any laws which relate to the appliance.

Our goods come with guarantees that cannot be excluded under the Australian Consumer Law and under the New Zealand Consumer Guarantees Act.

In Australia you are entitled to a replacement or refund for a major failure and for compensation for any other reasonably foreseeable loss or damage. You are also entitled to have the goods repaired or replaced if the goods fail to be of acceptable quality and the failure does amount to a major failure.

Should your appliance require repair or service after the guarantee period, contact your nearest Sunbeam service centre.

For a complete list of Sunbeam's authorised service centres visit our website or call:

Australia

www.sunbeam.com.au

1300 881 861

Units 5 & 6, 13 Lord Street
Botany NSW 2019 Australia

New Zealand

www.sunbeam.co.nz

0800 786 232

26 Vestey Drive, Mt Wellington
Auckland, New Zealand

Need help with your appliance?

Contact our customer service team or visit our website for information and tips on getting the most from your appliance.

In Australia

Visit www.sunbeam.com.au

Or call 1300 881 861

In New Zealand

Visit www.sunbeam.co.nz

Or call 0800 786 232

 is a registered trademark.

'Gelateria' is a registered trademark of Sunbeam Corporation.

Made in China.

Due to minor changes in design or otherwise, the product may differ from the one shown in this leaflet.

© Copyright. Sunbeam Corporation Limited 2011.

ABN 45 000 006 771

Units 5 & 6, 13 Lord Street
Botany NSW 2019 Australia

Unit 3, Building D
26 Vestey Drive
Mt Wellington Auckland
New Zealand

Sunbeam Corporation is a division of GUD Holdings Ltd.