

Elo Entuitive Touchmonitor User Guide

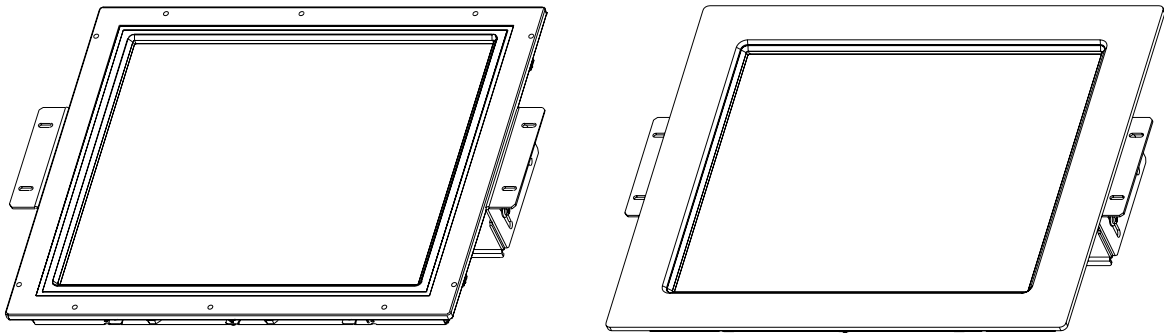

For 17" LCD Modular Kiosk Touchmonitors
1747L/1767L Series



Elo Entuitive Touchmonitor

User Guide

17" LCD Modular Kiosk Touchmonitors
1747L/1767L Series



Revision C

P/N 008559E

Elo TouchSystems, Inc.
1-800-ELOTOUCH
www.elotouch.com



Copyright © 2005 Elo TouchSystems Inc. All Rights Reserved.

No part of this publication may be reproduced, transmitted, transcribed, stored in a retrieval system, or translated into any language or computer language, in any form or by any means, including, but not limited to, electronic, magnetic, optical, chemical, manual, or otherwise without prior written permission of Elo TouchSystems.

Disclaimer

The information in this document is subject to change without notice. Elo TouchSystems makes no representations or warranties with respect to the contents hereof, and specifically disclaims any implied warranties of merchantability or fitness for a particular purpose. Elo TouchSystems reserves the right to revise this publication and to make changes from time to time in the content hereof without obligation of Elo TouchSystems to notify any person of such revisions or changes.

Trademark Acknowledgments

IntelliTouch, iTouch, SecureTouch, AccuTouch, Entuitive, and MonitorMouse are trademarks of Elo TouchSystems Inc.

Other product names mentioned herein may be trademarks or registered trademarks of their respective companies. Elo TouchSystems claims no interest in trademarks other than its own.

Table of Contents

Chapter 1			
Introduction	1		
Precautions	1		
About the Product	1		
Chapter 2			
Installation and Setup	3		
Unpacking Your Touchmonitor	3		
Product Overview	4		
Main Unit	4		
Rear View	4		
Side View	5		
Top View	5		
Attaching the L-Brackets	6		
Panel Cut Out	6		
1747L Option 1	6		
1747L Option 2	7		
1747L Option 3	8		
1767L Option 1	9		
1767L Option 2	10		
Touch Interference Connection	11		
STEP 1-Connecting the Video Cable	12		
STEP 2-Connecting the Serial or USB Touchscreen cable	13		
STEP 3-Connecting the OSD Remote Cable	14		
STEP 4-Connecting the Power Cable	15		
Optimizing the LCD Display	16		
VESA Mount on Your Touchmonitor	16		
VESA Mounting Interface	17		
Installing the Drive Software	18		
Installing the Serial Touch Driver	19		
Installing the Serial Touch Driver for Windows XP, 2000, Me, 95/98 and NT 4.0	19		
Installing the Serial Touch Driver for MS-DOS and Windows 3.1	20		
Installing the USB Touch Driver	21		
Installing the USB Touch Driver for Windows XP, 2000, Me and 98	21		
Chapter 3			
Operation	23		
About Touchmonitor Adjustments	23		
Using the On-Screen Display (OSD) Menus	23		
Remote OSD Buttons	24		
OSD Menu Function	25		
Chapter 4			
Trouble shooting	27		
Solutions to Common Problems	27		
Appendix A			
Native Resolution	29		
Appendix B			
Touchmonitor Safety	31		
Care and Handling of your Touchmonitor	32		
Appendix C			
Technical Specifications	33		
Compatible Video Modes	33		
Touchmonitor Specifications	34		
17" LCD Touchmonitor (ET 17X7L-XXWF-X) Dimensions	38		
Regulatory Information	39		
Warranty	43		
Index	45		

1

INTRODUCTION

Congratulations on your purchase of an Elo TouchSystems Entuitive touchmonitor. Your new touchmonitor combines the reliable performance of Elo's touch technology with the latest advances in LCD display design. This combination of features creates a natural flow of information between a user and your touchmonitor.

Precautions

Follow all warnings, precautions and maintenance as recommended in this user's manual to maximize the life of your unit. See Appendix B for more information on touchmonitor safety.

About the Product

Your LCD Kiosk Touchmonitor is a 17.0" SXGA TFT color display with the following features:

- Direct analog RGB or Digital RGB input
- 17.0" diagonal screen size
- 16.2M color (6 bit + FRC)
- 1280 x 1024 resolution
- SXGA/XGA/SVGA/VGA/VESA/Mac compatible
- 31.5kHz~80kHz horizontal scan
- 56.3~75Hz refresh rate

- Auto adjustment capability
- High quality full screen re-scaling
- Multilingual OSD menus in five languages: English, French, German, Spanish and Japanese.
- Serial or USB or both serial and USB touch interface (USB requires Windows 98, 2000, Me and XP.)
- Patented touch technology of Elo TouchSystems
- VESADDC 1/2B data communication
- VESADPMS power saving
- Cable management device
- VESA flat panel monitor physical mounting interface (Both of 75 & 100mm)
- Remote OSD and Power button lockouts
- Cable strain reliefs for all cables

For full Product Specifications refer to Appendix C.

2

INSTALLATION AND SETUP

This chapter discusses how to install your LCD touchmonitor and how to install Elo TouchSystems driver software.

Unpacking Your Touchmonitor

Check that the following 10 items are present and in good condition:

LCD Display

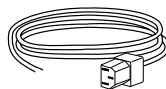

Monitor power cable
(US/Canada)

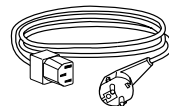

European monitor
power cable

Product Overview

Main Unit

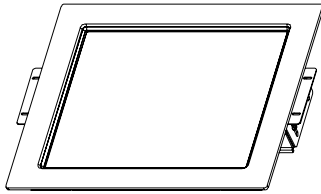

1767L Front-Mount

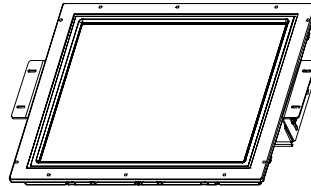

1747L Rear-Mount

Rear View

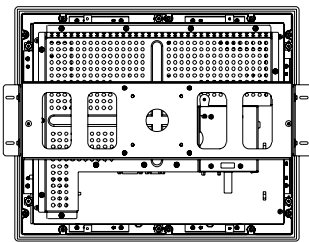

1767L

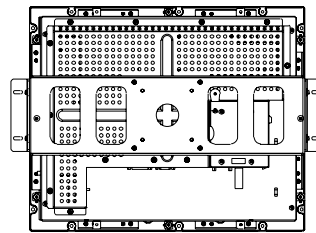

1747L

Bottom View(1747L shown)

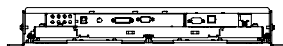

See Detail A

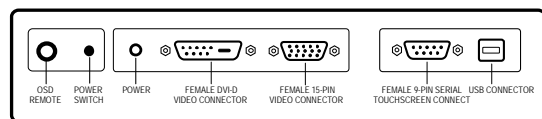

Detail A

Attaching the L-Brackets

Depending on your mounting scheme, use the L-brackets or the VESA 75/100mm standard holes located on the back of the kiosk monitor or the 5.5 diameter holes (only on rear mount). See page 15 for VESA mounting information.

NOTE: You will need a screwdriver to attach the L-brackets.

Your kiosk touchmonitor comes with a mounting bracket (C-bracket) attached at the back. Included are two L-brackets (and four screws) that attach to both ends of the C-bracket for additional mounting options.

To attach the L-brackets:

- 1 Lay the monitor face down.
- 2 Place the long end of the L-bracket against the end of the mounting C-bracket. Line up the two holes of the L-bracket with the two holes of the C-bracket. See the illustration below.

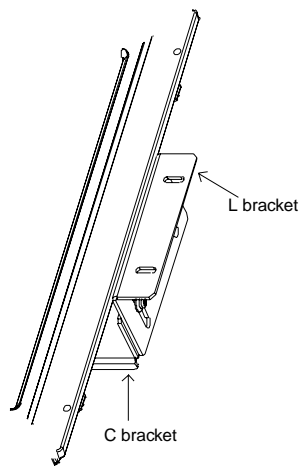

- 3 Place two screws in the holes and with the screwdriver, screw them in to secure the bracket.
- 4 Repeat steps 2 and 3 to attach the other L-bracket to the other side of the mounting bracket.

Panel Cut Outs

1747L Option 1

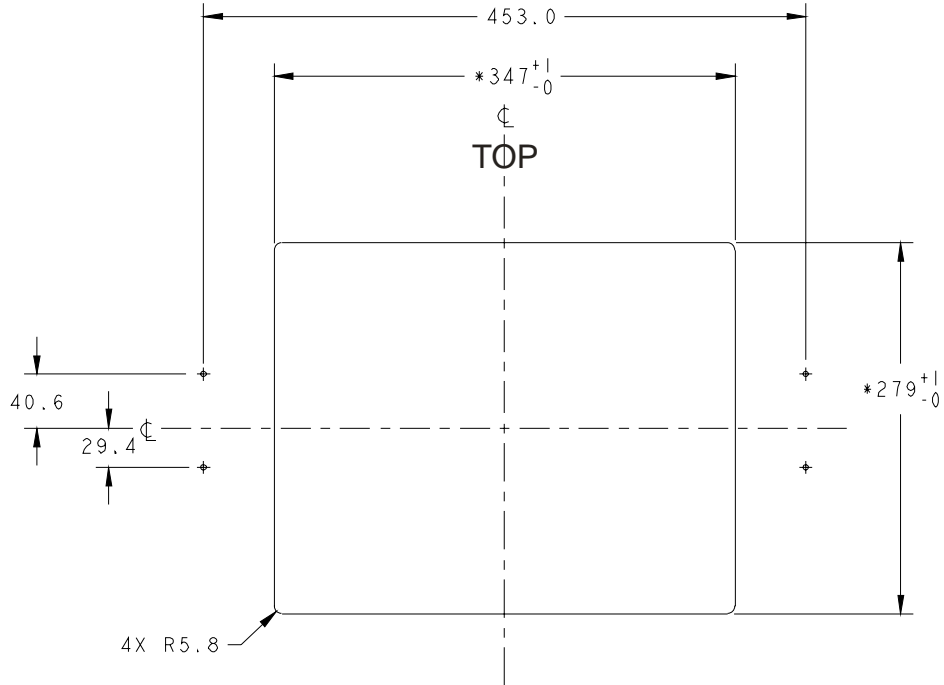

TOP

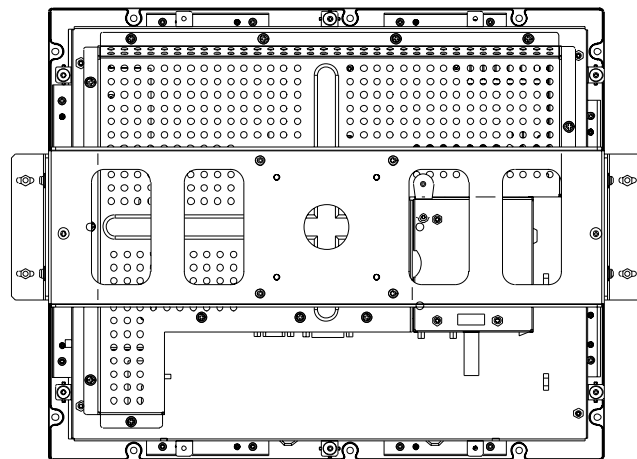

1747L Option 2

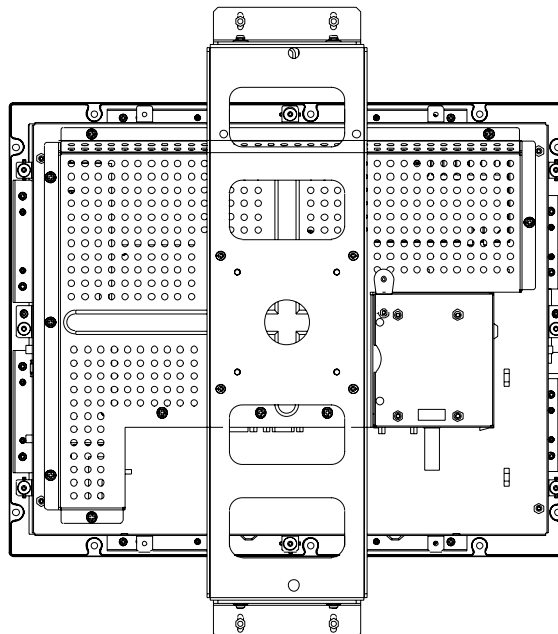
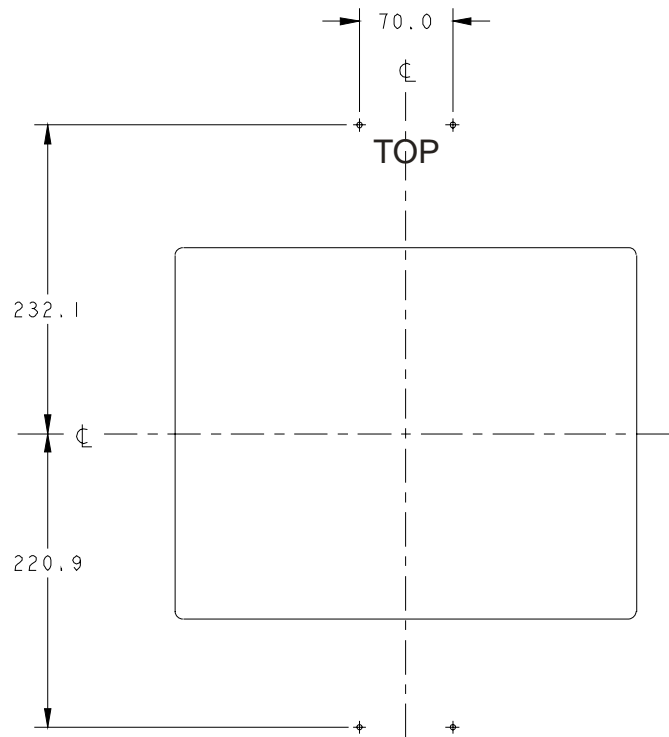

1747L Option 3

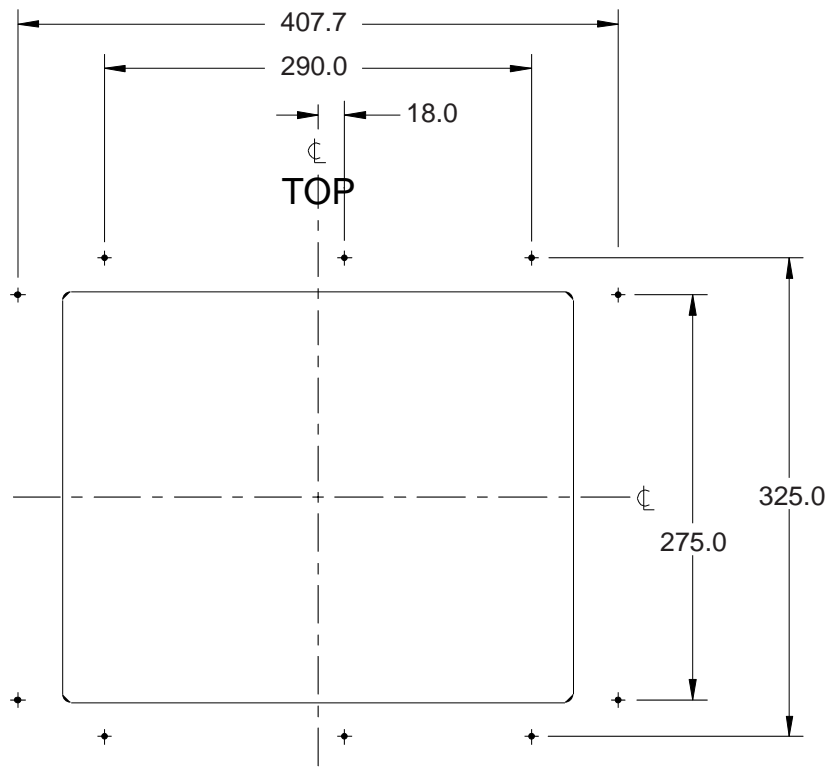

TOP

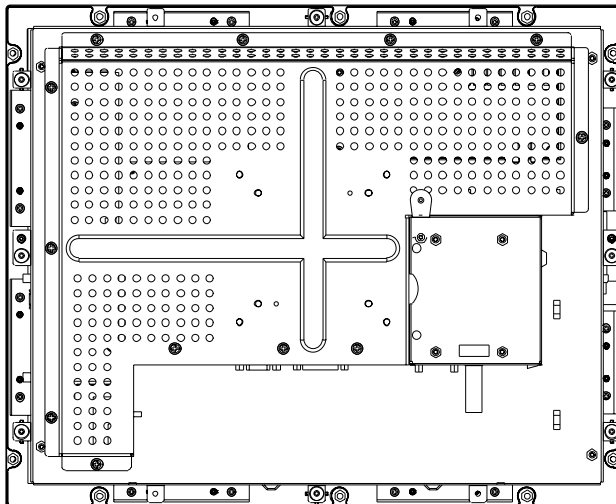

1767L Option 1

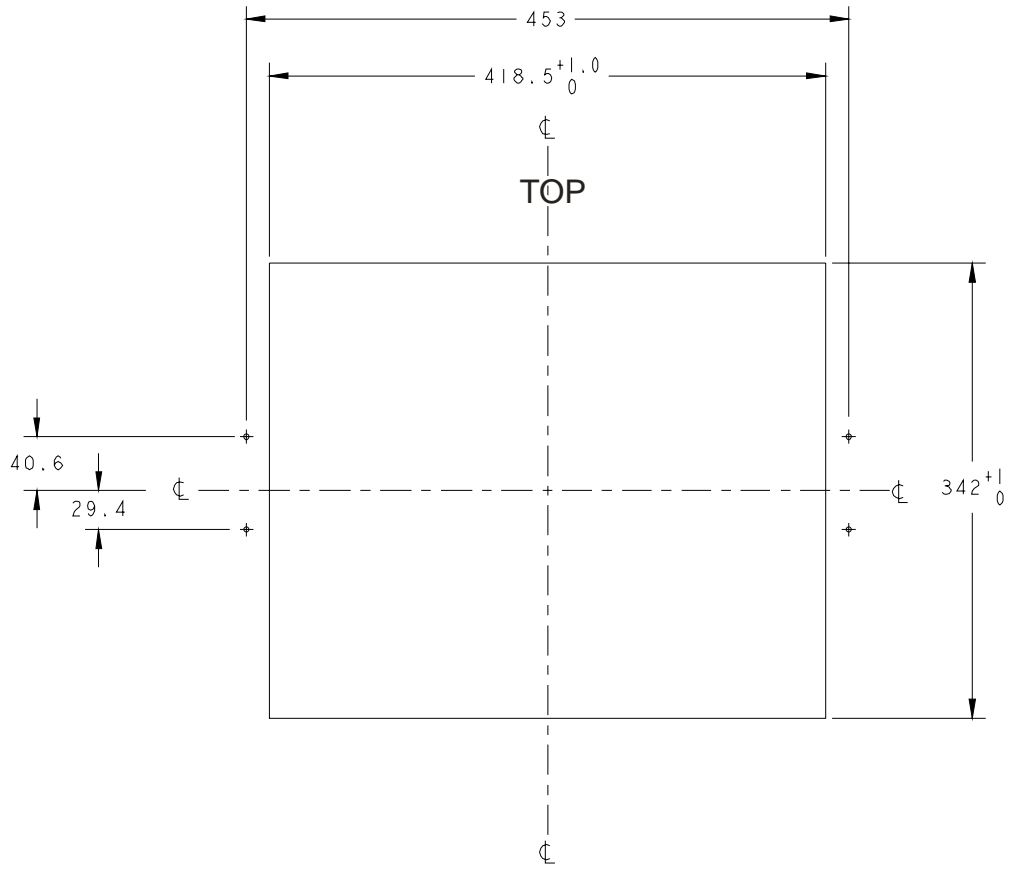

TOP

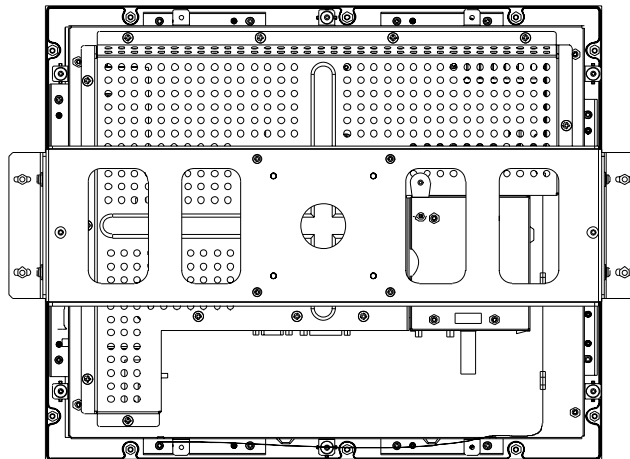

1767L Option 2

▶ 70 ◀



220.9



TOP

Touch Interface Connection

Your touchmonitor comes with one of the following touchscreen connector cables: Serial (RS-232) cable or USB cable. (For Windows 98, 2000, Me and XP systems only.)

To set up this display, please refer to the following figures and procedures:

Serial or USB or both serial and USB Connection

The following illustrations guide you step by step in connecting your touchmonitor using a serial or USB or both serial and USB cable connection.

When both serial and USB cable are connected with PC and touchscreen at the same time, the touch function is based on USB connection.

CAUTION



Before connecting the cables to your touchmonitor and PC, be sure that the computer and the touchmonitor are turned off.

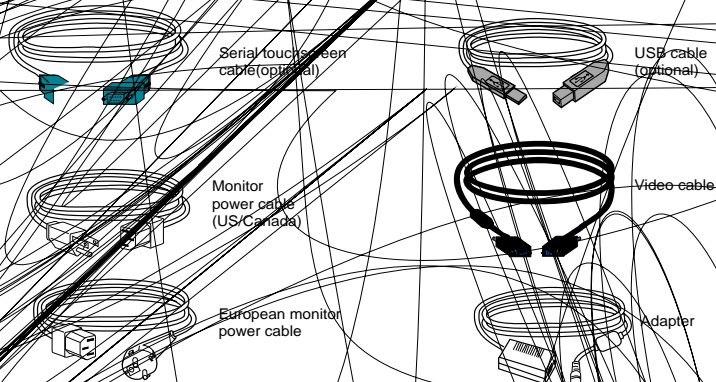
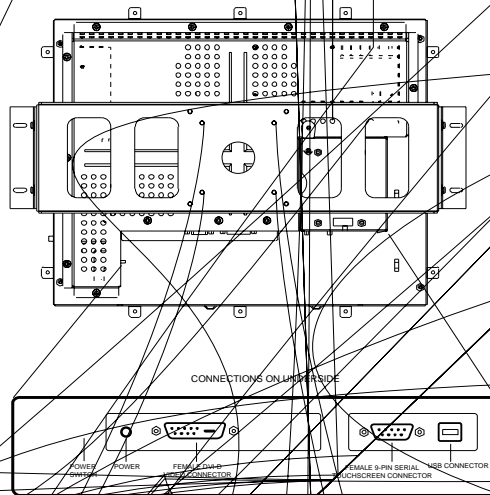

STEP 1-Connecting the Video Cable

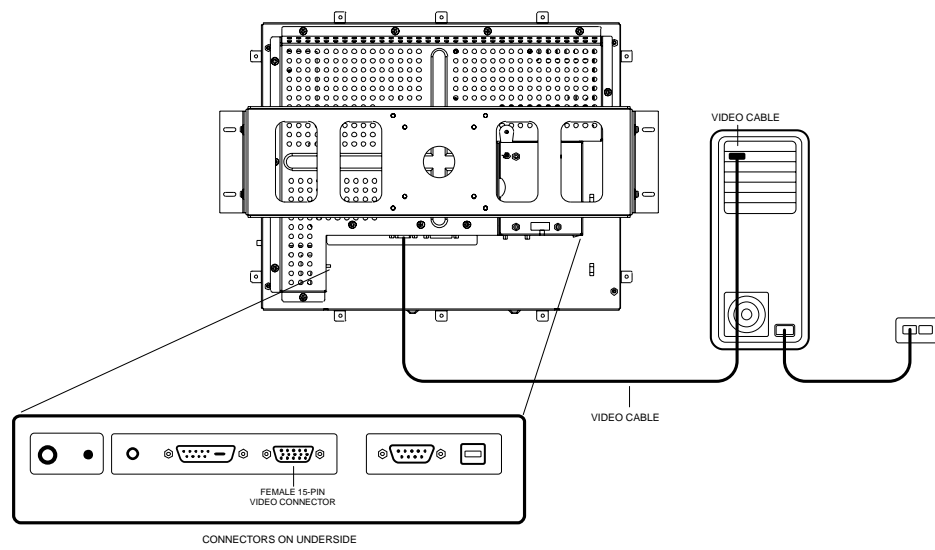

- Connect the 15-pin video cable (the ferrite bead end) or 24-pin DVI-D cable to the video port on your PC.
- Connect the other end of the video cable to the video connector on your touchmonitor.
- Secure the cable to your touchmonitor and PC by turning the screws on the connector clockwise.

STEP 2-Connecting the Serial or USB or both Serial and USB Touchscreen Cable

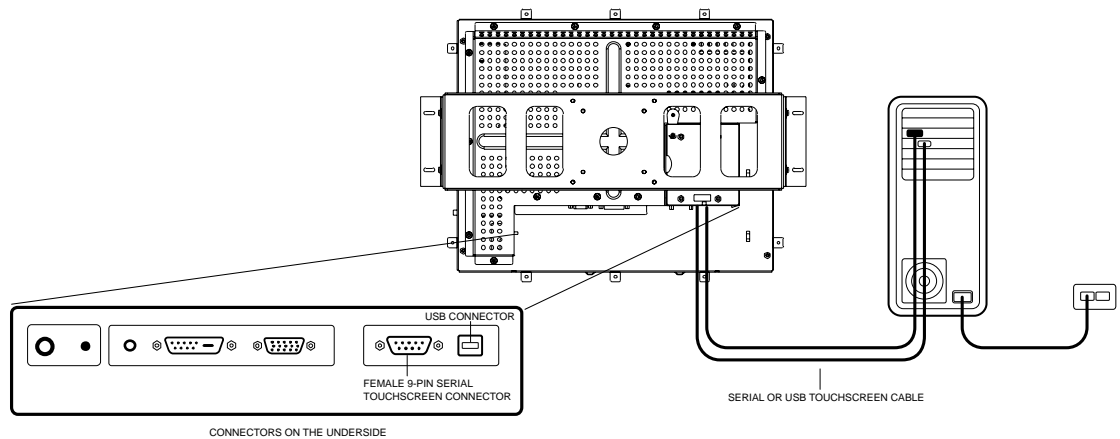

- Connect the female end of the serial (RS-232) cable to the serial port on your PC, or connect the USB touchscreen cable to the USB touchscreen connector on the back of your touchmonitor.
- Connect the male end of the cable to the serial touchscreen connector on your touchmonitor, or connect the other end of the USB touchscreen cable to your PC.
- Secure the cable to your touchmonitor and PC by turning the screws on the connector.
- When both serial and USB cable are connected with PC and touchscreen at the same time, the touch function is based on USB connection.

STEP 3-Connecting the OSD Remote Cable

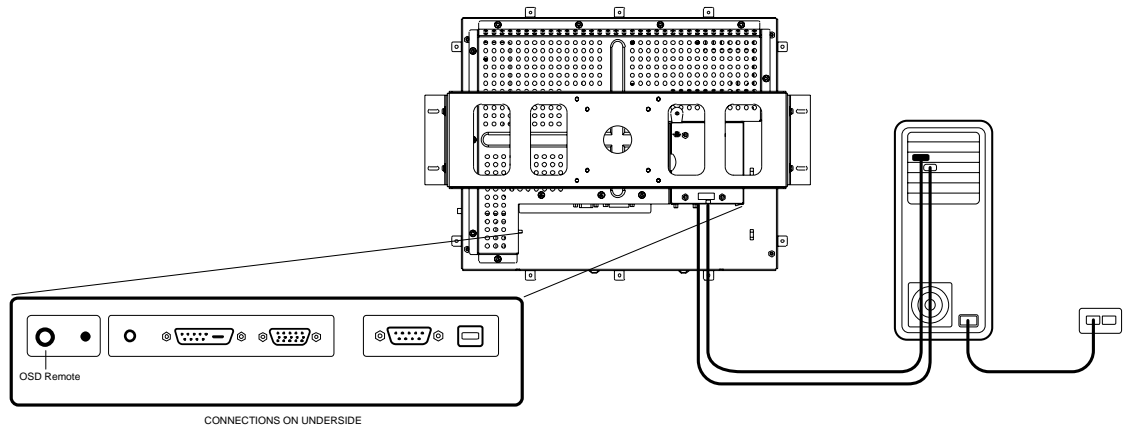

- Connect the 6-pin Remote OSDDIN cable to the black Remote OSD port of the monitor.

STEP 4-Connecting the Power Cable

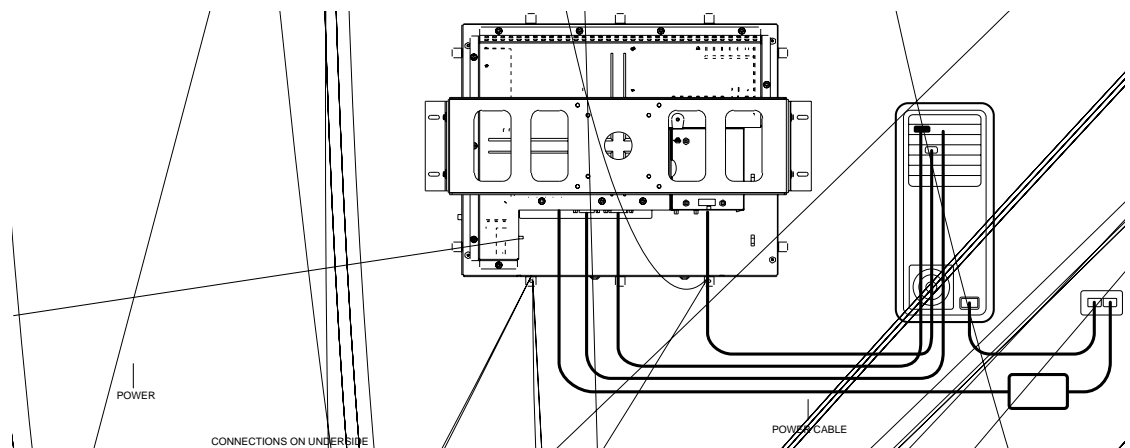

Depending on where you live, you will use either the European or US/Canadian power cable.

- Connect the female end of the power cable to the Brick power supply.
- Connect the Brick power cable into the power port on the touchmonitor.
- Route the cable through the cable management channel.

NOTE: To protect your equipment against risk of damage from electrical surges in the power line, plug the touchmonitor's power cord into a surge protector, and then connect the surge protector to a grounded AC electrical outlet.

Optimizing LCD Display

To ensure the LCD display works well with your computer, configure the display mode of your graphic card to make it less than or equal to 1280 x 1024 resolution, and make sure the timing of the display mode is compatible with the LCD display. Refer to Appendix A for more information about resolution. Compatible video modes for your touchmonitor are listed in Appendix C.

VESA Mounting Interface

Your touchmonitor conforms to the VESA Flat Panel Monitor Physical Mounting Interface (FPMPMI™) Standard which defines a physical mounting interface for flat panel monitors, and corresponding standards for flat panel monitor mounting devices, such as wall and table arms. The VESA mounting interface is located on the back of your touchmonitor and is shipped pre-connected to the base.

To use the VESA mount, unscrew the rear U bracket, then mount to either 75mm or 100mm VESA mount. Use M4x7 machine screws. Do not penetrate the screw into the monitor more than 10mm.

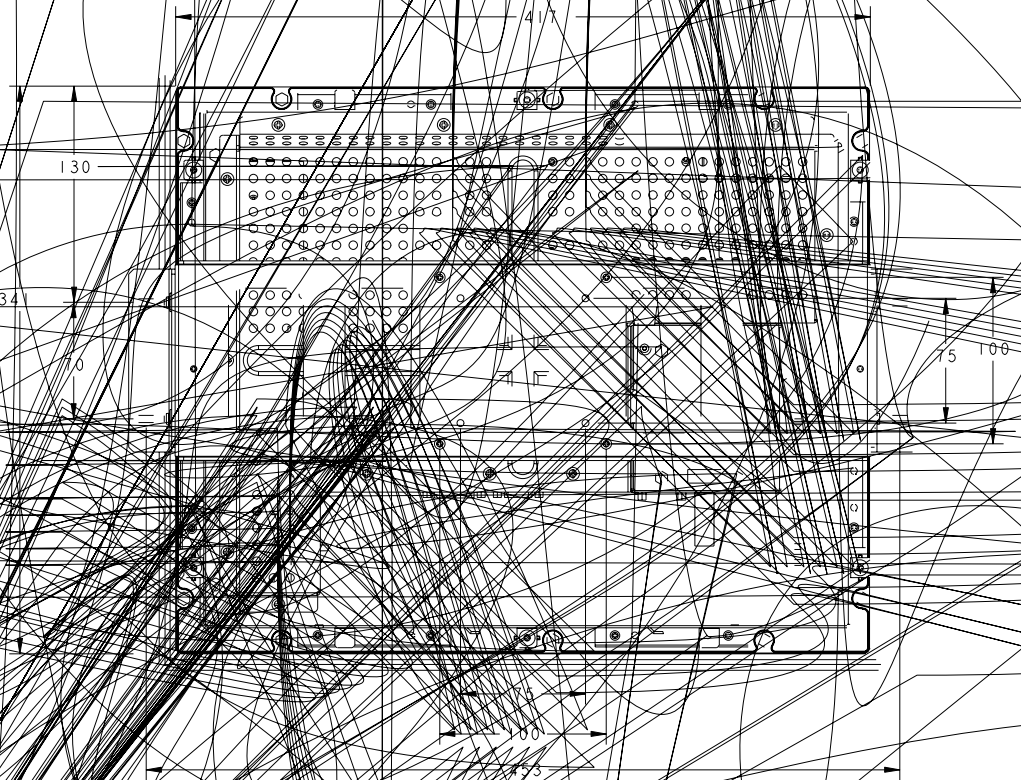

VESA Mounting Interface

Your monitor has standard VESA mounting holes on the rear of the unit. The holes are spaced at 75mm and 100mm standard.

The following companies provide VESA mounting devices compatible with your touchmonitor:

Ergotron

800-888-8458

651-681-7600

www.ergotron.com

GCX

800-228-2555

707-773-1100

www.gcx.com

Innovative Office Products

800-524-2744

610-253-9554

www.innov-office-prod.com

MRI

800-688-2414

www.mediarecovery.com

Installing the Driver Software

Elo TouchSystems provides driver software that allows your touchmonitor to work with your computer.

Drivers are located on the enclosed CD-ROM for the following operating systems:

- Windows XP
- Windows 2000
- Windows Me
- Windows 98
- Windows 95
- Windows NT 4.0

Additional drivers and driver information for other operating systems are available on the Elo TouchSystems web site at www.elotouch.com.

Your Elo touchmonitor is plug-and-play compliant. Information on the video capabilities of your touchmonitor is sent to your video display adapter when Windows starts. If Windows detects your touchmonitor, follow the instructions on the screen to install a generic plug-and-play monitor.

Refer to the appropriate following section for driver installation instructions.

Installing the Serial Touch Driver

Installing the Serial Touch Driver for Windows XP, Windows 2000, Me, 95/98 and NT 4.0

NOTE: For Windows 2000 and NT 4.0 you must have administrator access rights to install the driver.

- 1 Insert the Elo CD-ROM in your computer's CD-ROM drive.
- 2 If the AutoStart feature for your CD-ROM drive is active, the system automatically detects the CD and starts the setup program.
- 3 Follow the directions on the screen to complete the driver setup for your version of Windows.
- 4 If the AutoStart feature is not active:
- 5 Click **Start > Run**.
- 6 Click the **Browse** button to locate the EloCd.exe program on the CD-ROM.
- 7 Click **Open**, then **OK** to run EloCd.exe.
- 8 Follow the directions on the screen to complete the driver setup for your version of Windows.

To install Windows 2000 and Windows XP, you must use the "update driver" method; you will not find a setup.exe file within the download.

Installing the Serial Touch Driver for MS-DOS and Windows 3.1

You must have a DOS mouse driver (MOUSE.COM) installed for your mouse if you wish to continue using your mouse along with your touchmonitor in DOS.

To install Windows 3.x and MS-DOS from Windows 95/98, follow the directions below:

- 1 Insert the Elo CD-ROM in your computer's CD-ROM drive.
- 2 From DOS, type `d:\EloDos_W31` to change to the correct directory on the CD-ROM (your CD-ROM drive may be mapped to a different drive letter).
- 3 Type `install` and press **Enter** to start the installation.
- 4 Align the touchscreen.

You must have already completed Steps 1 and 2 before proceeding. Refer to Chapter 2 of the Elo DOS and Windows Driver Guide as necessary for additional installation information.

To run the INSTALL program:

- 1 Type `INSTALL` at the DOS prompt in the directory containing the driver install files.
- 2 `INSTALL` asks you to select the software to install. Then choose `d:\EloDos_W31` from the displayed list.
- 3 `INSTALL` also asks you for the paths to use during installation, or you may use its defaults. `INSTALL` creates directories as necessary, and warns you if they exist.

If you are updating your software, you may wish to specify the paths containing the earlier versions, and overwrite the obsolete files. All executable programs are upward compatible. For a list of differences from each previous version of the drivers, be sure to select "Differences from Previous Versions" during the installation process.

`INSTALL` updates your `AUTOEXEC.BAT` file with the drivers you select. `INSTALL` makes a copy of your original `AUTOEXEC.BAT` file, called `AUTOEXEC.OLD`. If you already have Elo driver commands in your `AUTOEXEC.BAT` file, they will be commented out.

When `INSTALL` is finished, it leaves a file called `GO.BAT` in the subdirectory you specified. `GO` loads the touchscreen driver, runs the calibration program `ELOCALIB`, and gives you some final instructions.

If you are using Windows 3.1, you will also calibrate the touchscreen within Windows 3.1 with the Touchscreen Control Panel.

Installing the USB Touch Driver

Installing the USB Touch Driver for Windows XP, Windows 2000, Me and 98

- 1 Insert the Elo CD-ROM in your computer's CD-ROM drive. If Windows 98, Windows Me or Windows 2000 starts the Add New Hardware Wizard:
- 2 Choose **Next**. Select "Search for the best driver for your device (Recommended)" and choose **Next**.
- 3 When a list of search locations is displayed, place a checkmark on "Specify a location" and use **Browse** to select the \EloUSB directory on the Elo CD-ROM.
- 4 Choose **Next**. Once the Elo TouchSystems USB touchscreen driver has been detected, choose **Next** again.
- 5 You will see several files being copied. Insert your Windows 98 CD if prompted. Choose **Finish**.

If Windows 98, Windows Me or Windows 2000 does not start the Add New Hardware Wizard:

NOTE: For Windows 2000 you must have administrator access rights to install the driver.

- 1 Insert the Elo CD-ROM in your computer's CD-ROM drive. If the AutoStart feature for your CD-ROM drive is active, the system automatically detects the CD and starts the setup program.
- 2 Follow the directions on the screen to complete the driver setup for your version of Windows.

If the AutoStart feature is not active:

- 1 Click **Start > Run**.
- 2 Click the **Browse** button to locate the EloCd.exe program on the CD-ROM.
- 3 Click **Open**, then **OK** to run EloCd.exe.
- 4 Follow the directions on the screen to complete the driver setup for your version of Windows.

To install Windows 2000 and Windows XP, you must use the "update driver" method; you will not find a setup.exe file within the download.

3

OPERATION

About Touchmonitor Adjustments

Your touchmonitor will unlikely require adjustment. Variations in video output and application may require adjustments to your touchmonitor to optimize the quality of the display.

For best performance, your touchmonitor should be operating in native resolution, that is 1280 x 1024 at 80k-75 Hz. Use the Display control panel in Windows to choose 1280 x 1024 resolution.

Operating in other resolutions will degrade video performance. For further information, please refer to Appendix A.

All adjustments you make to the controls are automatically memorized. This feature saves you from having to reset your choices every time you unplug or power your touchmonitor off and on. If there is a power failure your touchmonitor settings will not default to the factory specifications.

Using the On-Screen Display (OSD) Menus

All adjustments are made by using the on-screen display (OSD) menus. All menu items can be selected by using the buttons on the Remote OSD key.

NOTE: OSD menu default is enabled.

Remote OSD Buttons

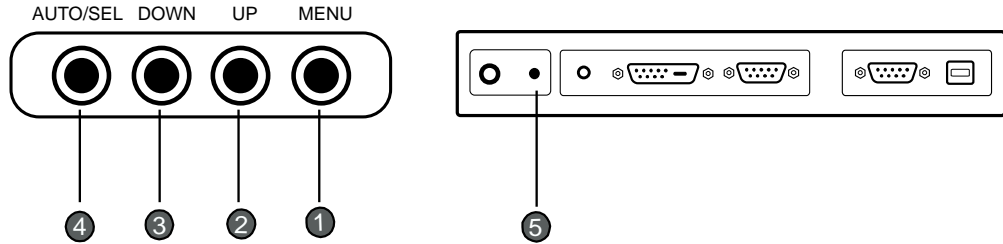
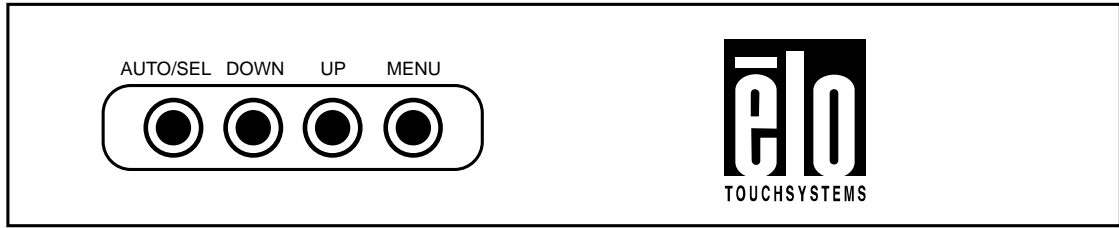





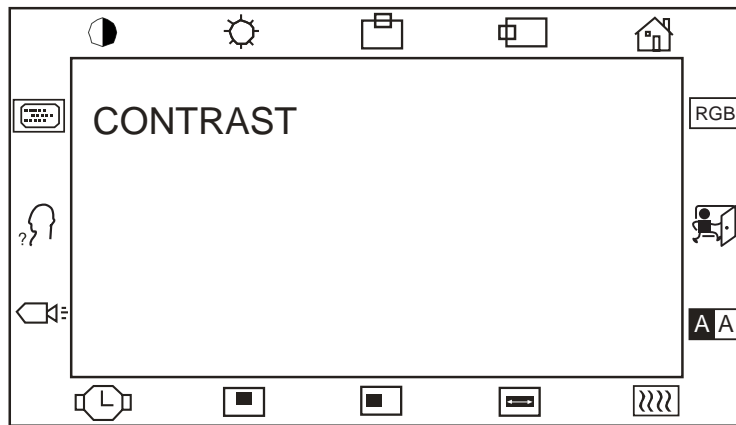





	Control	Function
1 MENU	Menu	Display/Exits the OSD menus.
2 Up	Brightness/ Plus/Clockwise	1. Adjust brightness of the OSD. 2. Increase value of the adjustment item. 3. Select item clockwise.
3 Down	Minus Counter-clockwise	1. Decrease value of the adjustment item. 2. Select item counter-clockwise.
4 AUTO/SEL	Enter Select item	Select- To select the adjustment items from the OSD menus. Auto- To activate the "A uto Adjustment" function to obtain an optimum image.
5 Power Switch	Switches on/off	the power of your touchmonitor.
	Enable/Disable	1. Press the Menu and ◀ buttons at the same time and hold for two seconds to enable/disable the OSD functions. OSD menu default is enabled. 2. Press the Menu and ▶ buttons at the same time and hold for two seconds to enable/disable the power lock function.

OSD Menu Function



Function	Symbol	Process
Contrast		Controls the picture contrast
Brightness		Controls the picture brightness.
Left/Right		Controls the horizontal position.
Up/Down		Controls the vertical position.
Recall defaults		Recall factory settings of the image parameters.
Color Temperature		In this menu you can select one of the default color temperatures (5500°K, 6500°K, 9300°K) Press the OSD button Up and Down or set color values individually using the "USER" option. To define the color values individually, select the "USER" option. You can switch between the setting options for R/G/B (red, green and blue foreground) using the OSD direction button. Select and specify the desired value by using the OSD button.

EXIT		Escape main-OSD
Sharpness		Adjusts csharpness.
Phase		Controls the vertical and horizontal fine tuning.
Clock		Controls the horizontal image size.
OSD Left/Right		Adjusts the horizontal position of the OSD menu.
OSD Up/Down		Adjusts the vertical position of the OSD menu.
OSD Timeout		Determines how long (in seconds) the OSD menu waits before closing automatically after no action has been performed.
Auto Adjust		Automatically selects the optional settings for image parameters (brightness, contrast, image position, phase etc). Display the current graphic mode.
Language		Selection of the OSD menu language: English, French, German, Spanish, Japanese.
DSUB Analog/ DVIDigital		Select the connection for the display. DSUB Analog(15-pin connector) or DVIDigital (24-pin connector). In this way you can connect your to 2 computers (by simultaneously using both connectors) and switch between displays.

4

TROUBLESHOOTING

If you are experiencing trouble with your touchmonitor, refer to the following table. If the problem persists, please contact your local dealer or our service center.

Solutions to Common Problems

Problem	Suggestion(s)
No image appears on screen.	<p>Check that all the I/O and power connectors are properly connected as described in Chapter 2.</p> <p>Make sure the pins of the connectors are not crooked or broken.</p> <p>Test power supply by trying different cables, a different wall outlet or plug another appliance into the outlet.</p> <p>Make certain the video cable is properly connected and that it is not damaged. Check for bent pins on the cable connectors.</p> <p>Ensure that your computer and video card are properly configured. (Consult video card documentation.)</p>
“Out of Range” display	<p>Check to see if the resolution of your computer is higher than that of the LCD display.</p> <p>Reconfigure the resolution of your computer to make it less than or equal to 1280 x 1024. See Appendix A for more information on resolution.</p>
OSD/Power buttons don't respond	See page 3-26 for OSD enable/disable.

Image has vertical flickering line bars.	Use “Phase” to make an adjustment. Check and reconfigure the display mode of the vertical refresh rate of your graphic card to make it compatible with the LCD display.
Image is unstable and flickering Image is scrolling	Use “CLOCK” to make an adjustment. Make sure the VGA signal cable (or adapter) is well connected. Check and reconfigure the display mode of the vertical refresh rate of your graphic card to make it compatible with the LCD display.
Touch doesn't work	Make sure cable is securely attached at both ends.



NATIVE RESOLUTION

The native resolution of a monitor is the resolution level at which the LCD panel is designed to perform best. For the Elo LCD touchmonitor, the native resolution is 1280 x 1024 for the SXGA-17 inch size. In almost all cases, screen images look best when viewed at their native resolution. You can lower the resolution setting of a monitor but not increase it.

Input Video	17" LCD
640 x 480 (VGA)	Transforms input format to 1280 x 1024
800 x 600 (SVGA)	Transforms input format to 1280 x 1024
1024 x 768 (XGA)	Transforms input format to 1280 x 1024
1280 x 1024 (SXGA)	Displays in Native Resolution

The native resolution of an LCD is the actual number of pixels horizontally in the LCD by the number of pixels vertically in the LCD. LCD resolution is usually represented by the following symbols:

VGA	640 x 480
SVGA	800 x 600
XGA	1024 x 768
SXGA	1280 x 1024
UXGA	1600 x 1200

As an example, a SVGA resolution LCD panel has 800 pixels horizontally by 600 pixels vertically. Input video is also represented by the same terms. XGA input video has a format of 1024 pixels horizontally by 768 pixels vertically. When the input pixels contained in the video input format match the native resolution of the panel, there is a one to one correspondence of mapping of input video pixels to LCD pixels. As an example, the pixel in column 45 and row 26 of the input video is in column 45 and row 26 of the LCD. For the case when the input video is at a lower resolution than the native resolution of the LCD, the direct correspondence between the video pixels and the LCD pixels is lost. The LCD controller can compute the correspondence between video pixels and LCD pixels using algorithms contained on its controller. The accuracy of the algorithms determines the fidelity of conversion of video pixels to LCD pixels. Poor fidelity conversion can result in artifacts in the LCD displayed image such as varying width characters.

B

TOUCHMONITOR SAFETY

This manual contains information that is important for the proper setup and maintenance of your touchmonitor. Before setting up and powering on your new touchmonitor, read through this manual, especially Chapter 2 (Installation), and Chapter 3 (Operation).

1. To reduce the risk of electric shock, follow all safety notices and never open the touchmonitor case.
2. Turn off the product before cleaning
3. Your new touchmonitor is equipped with a 3-wire, grounding power cord. The power cord plug will only fit into a grounded outlet. Do not attempt to fit the plug into an outlet that has not been configured for this purpose. Do not use a damaged power cord. Use only the power cord that comes with your Elo TouchSystems Touchmonitor. Use of an unauthorized power cord may invalidate your warranty.
4. The slots located on the sides and top of the touchmonitor case are for ventilation. Do not block or insert anything inside the ventilation slots.
5. It is important that your touchmonitor remains dry. Do not pour liquid into or onto your touchmonitor. If your touchmonitor becomes wet do not attempt to repair it yourself.

Care and Handling of Your Touchmonitor

The following tips will help keep your Elo Entuitive touchmonitor functioning at the optimal level.

- To avoid risk of electric shock, do not disassemble the brick supply or display unit cabinet. The unit is not user serviceable. Remember to unplug the display unit from the power outlet before cleaning.
- Do not use alcohol (methyl, ethyl or isopropyl) or any strong dissolvent. Do not use thinner or benzene, abrasive cleaners or compressed air.
- To clean the display unit cabinet, use a cloth lightly dampened with a mild detergent.
- Avoid getting liquids inside your touchmonitor. If liquid does get inside, have a qualified service technician check it before you power it on again.
- Do not wipe the screen with a cloth or sponge that could scratch the surface.
- To clean the touchscreen, use window or glass cleaner. Put the cleaner on the rag and wipe the touchscreen. Never apply the cleaner directly on the touchscreen

C

TECHNICAL SPECIFICATIONS

Compatible Video Modes

Your Elo Entuitive touchmonitor is compatible with the following standard video modes:

Mode	Resolution	H. Frequency (kHz)	V. Frequency (Hz)
VGA	720 x 350	31,470	70
VGA	720 x 400	31,470	70
VGA	640 x 480	31,470	60
MAC	640 x 480	35,000	66
VESA	640 x 480	37,860	72
VESA	640 x 480	37,500	75
VESA	800 x 600	35,160	56
VESA	800 x 600	37,880	60
VESA	800 x 600	46,880	75
VESA	800 x 600	48,080	72
MAC	832 x 624	49,720	75
VESA	1024 x 768	48,360	60
VESA	1024 x 768	56,480	70
VESA	1024 x 768	60,020	75
SXGA	1280 x 1024	64,000	60
SXGA	1280 x 1024	80,000	75
SXGA	1152 x 864	67,500	75
SXGA	1280 x 960	60,000	60
SUN	1024x768	52,450	65

Touchmonitor Specifications

Table C.1 17" LCD Touchmonitor (ET17X7L-XXWF-1) Specifications

Display Type	Active matrix, thin film transistor (TFT), liquid crystal display	
Size	17-inch diagonal 338 x 270 mm useful screen area	
Pixel Format	1280 x 1024	
Touchscreen	0.125-inch IntelliTouch and AccuTouch, anti-glare IntelliTouch or AccuTouch	
Colors	16 million with dithering, 6 bit per color data	
Display Brightness	Non-Touch: 260 cd/m ² (Typical) AccuTouch:213cd/m ² (Typical) IntelliTouch:239cd/m ² (Typical) SecureTouch:234cd/m ² (Typical) Surface Capacitive Touch: 218cd/m ² (Typical)	
Back-light Lamp Life	50,000 hours at 50% brightness typical	
Viewing Angle	Horizontal -70 degrees(left)/ 70 degrees(right) at a CR>10 Vertical -60 degrees(looking up)/67 degrees (looking down) at a CR>10	
Contrast Ratio	450:1 typical	
Display Response Time	9 ms(tr)/ 16 ms(tf) Typical	
Environmental	Operating Temp	0° C to 40° C
	Storage Temp	-20° C to +60° C
	Humidity	80% non-condensing AT 95% IT
Mechanical	Weight	Actual: 6.82kg (15.06 lbs) Actual Shipping: 10.97kg (24.18 lbs.)
	Size	See drawings on next page.
Electrical	Input Video	VGA/SVGA/XGA/SXGA analog or digital video
	Input Power	Main Adapter: 100-240V~, 50/60Hz/ LCD:11.4-19.95V =, 12V = 4A max, 19V = 2.65A max.
	Power Dissipation	Universal
Agencies	Safety & EMC	UL, CUL and TUV Bauart FCC-B, CE, VCCI, C-Tick, ICES-03

Table C.2 IntelliTouch Touchmonitor Specifications

Mechanical	
Positional Accuracy	Standard deviation of error is less than 0.080 in. (2.03 mm). Equates to less than $\pm 1\%$.
Touchpoint Density	More than 100,000 touchpoints/in ² (15,500 touchpoints/cm ²).
Touch Activation Force	Typically less than 3 ounces (85 grams).
Surface Durability	Surface durability is that of glass, Mohs' hardness rating of 7.
Expected Life Performance	No known wear-out mechanism, as there are no layers, coatings, or moving parts. IntelliTouch technology has been operationally tested to more than 50 million touches in one location without failure, using a stylus similar to a finger.
Sealing	
Unit is sealed to protect against splashed liquids, dirt, and dust.	
Optical	
Light Transmission (per ASTM D1003)	82% AccuTouch; 92% IntelliTouch Typical; 84% Surface Capacitive
Visual Resolution	All measurements made using USAF 1951 Resolution Chart, under 30X magnification, with test unit located approximately 1.5 in (38 mm) from surface of resolution chart. Clear surface: Excellent, with no noticeable degradation. Antiglare surface: 6:1 minimum.
Gloss (per ASTM D2457 using a 60-degree gloss meter)	Antiglare surface: Curved: 60 ± 20 gloss units or 75 ± 15 gloss units.

Environmental**Chemical Resistance**

The active area of the touchscreen is resistant to all chemicals that do not affect glass, such as:

Acetone

Toluene

Methyl ethyl ketone

Isopropyl alcohol

Methyl alcohol

Ethyl acetate

Ammonia-based glass cleaners

Gasoline

Kerosene

Vinegar

Electrostatic**Protection (per EN 61000-4-2, 1995)**

Meets Level 4 (15 kV air/8 kV contact discharges).

Table C.3 AccuTouch Touchmonitor Specifications

Mechanical	
Construction	Top: Polyester with outside hard-surface coating with clear or antiglare finish. Inside: Transparent conductive coating. Bottom: Glass substrate with uniform resistive coating. Top and bottom layers separated by Elo-patented separator dots.
Positional Accuracy	Standard deviation of error is less than 0.080 in. (2.03 mm). This equates to less than $\pm 1\%$.
Touchpoint Density	More than 100,000 touchpoints/in ² (15,500 touchpoints/cm ²).
Touch Activation Force	Typically less than 4 ounces (113 grams).
Surface Durability	Meets Taber Abrasion Test (ASTMD1044), CS-10F wheel, 500 g. Meets pencil hardness 3H.
Expected Life Performance	AccuTouch technology has been operationally tested to greater than 35 million touches in one location without failure, using a stylus similar to a finger.
Optical	
Light Transmission (per ASTMD1003)	Typically 75% at 550-nm wavelength (visible light spectrum).
Visual Resolution	All measurements made using USAF 1951 Resolution Chart, under 30 X magnification, with test unit located approximately 1.5 in. (38 mm) from surface of resolution chart. Antiglare surface: 6:1 minimum.
Haze (per ASTMD1003)	Antiglare surface: Less than 15%.
Gloss (per ASTMD2457)	Antiglare surface: 90 ± 20 gloss units tested on a hard-coated front surface.

17" LCD Touchmonitor (ET17X7L-XXWF-X)Dimensions

NOTES FOR ALL MOUNTING OPTIONS:

Material: Wood: \varnothing 4.5 holes thru for M4 screws with nuts or screws for wood \varnothing 4mm.
 Sheet metal: Concealed head threaded studs M4 with nuts.

1767L

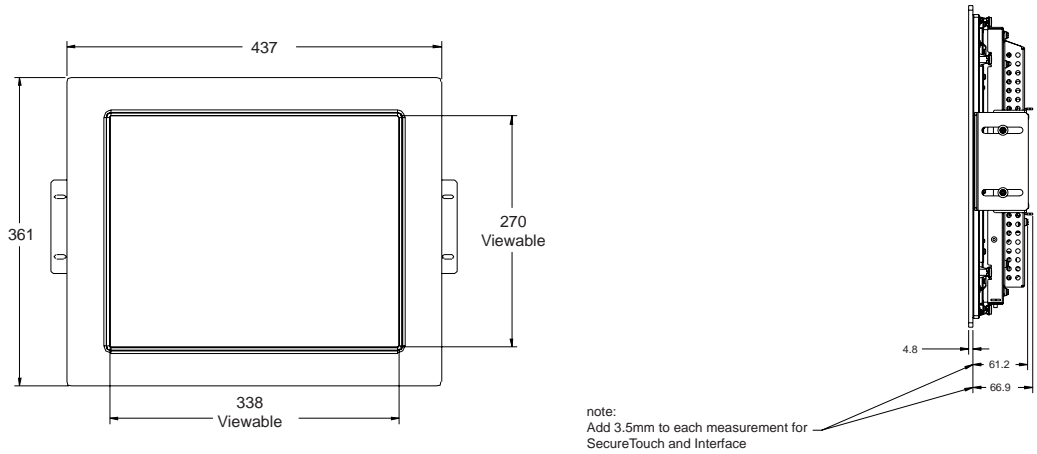

1747L

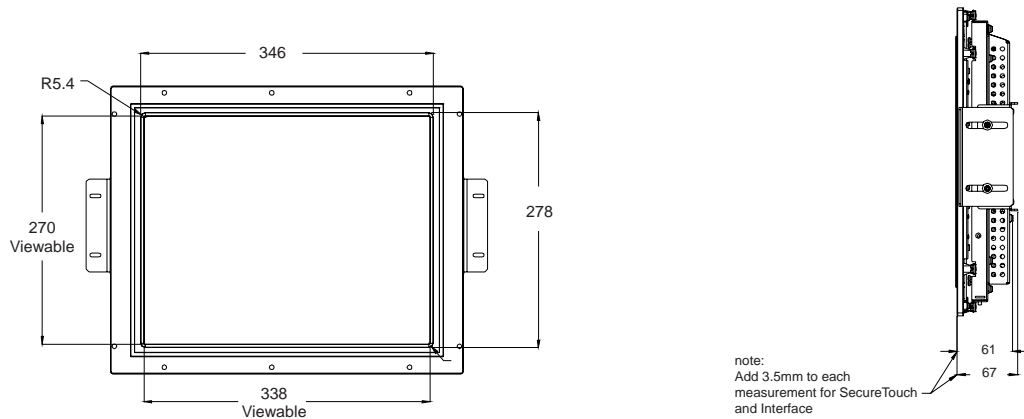

REGULATORY INFORMATION

I. Electrical Safety Information:

A) Compliance is required with respect to the voltage, frequency, and current requirements indicated on the manufacturer's label. Connection to a different power source than those specified herein will likely result in improper operation, damage to the equipment or pose a fire hazard if the limitations are not followed.

B) There are no operator serviceable parts inside this equipment. There are hazardous voltages generated by this equipment which constitute a safety hazard. Service should be provided only by a qualified service technician.

C) This equipment is provided with a detachable power cord which has an integral safety ground wire intended for connection to a grounded safety outlet.

- 1) Do not substitute the cord with other than the provided approved type. Under no circumstances use an adapter plug to connect to a 2-wire outlet as this will defeat the continuity of the grounding wire.
- 2) The equipment requires the use of the ground wire as a part of the safety certification, modification or misuse can provide a shock hazard that can result in serious injury or death.
- 3) Contact a qualified electrician or the manufacturer if there are questions about the installation prior to connecting the equipment to mains power.

II. Emissions and Immunity Information

A) Notice to Users in the United States: This equipment has been tested and found to comply with the limits for a Class B digital device, pursuant to Part 15 of FCC Rules. These limits are designed to provide reasonable protection against harmful interference in a residential installation. This equipment generates, uses, and can radiate radio frequency energy, and if not installed and used in accordance with the instructions, may cause harmful interference to radio communications.

B) Notice to Users in Canada: This equipment complies with the Class B limits for radio noise emissions from digital apparatus as established by the Radio Interference Regulations of Industrie Canada.

C) Notice to Users in the European Union: Use only the provided power cords and interconnecting cabling provided with the equipment. Substitution of provided cords and cabling may compromise electrical safety or CE Mark Certification for emissions or immunity as required by the following standards:

This Information Technology Equipment (ITE) is required to have a CE Mark on the manufacturer's label which means that the equipment has been tested to the following Directives and Standards:

This equipment has been tested to the requirements for the CE Mark as required by EMC Directive 89/336/EEC indicated in European Standard EN 55 022 Class B and the Low Voltage Directive 73/23/EEC as indicated in European Standard EN 60 950.

D) General Information to all Users: This equipment generates, uses and can radiate radio frequency energy. If not installed and used according to this manual the equipment may cause interference with radio and television communications. There is, however, no guarantee that interference will not occur in any particular installation due to site-specific factors.

1) In order to meet emission and immunity requirements, the user must observe the following:

- a) Use only the provided I/O cables to connect this digital device with any computer.
- b) To ensure compliance, use only the provided manufacturer's approved line cord.
- c) The user is cautioned that changes or modifications to the equipment not expressly approved by the party responsible for compliance could void the user's authority to operate the equipment.

2) If this equipment appears to cause interference with radio or television reception, or any other device:

- a) Verify as an emission source by turning the equipment off and on.
- b) If you determine that this equipment is causing the interference, try to correct the interference by using one or more of the following measures:
 - i) Move the digital device away from the affected receiver.
 - ii) Reposition (turn) the digital device with respect to the affected receiver.
 - iii) Reorient the affected receiver's antenna.
 - iv) Plug the digital device into a different AC outlet so the digital device and the receiver are on different branch circuits.
 - v) Disconnect and remove any I/O cables that the digital device does not use. (Unterminated I/O cables are a potential source of high RF emission levels.)
 - vi) Plug the digital device into only a grounded outlet receptacle. Do not use AC adapter plugs. (Removing or cutting the line cord ground may increase RF emission levels and may also present a lethal shock hazard to the user.)

If you need additional help, consult your dealer, manufacturer, or an experienced radio or television technician.

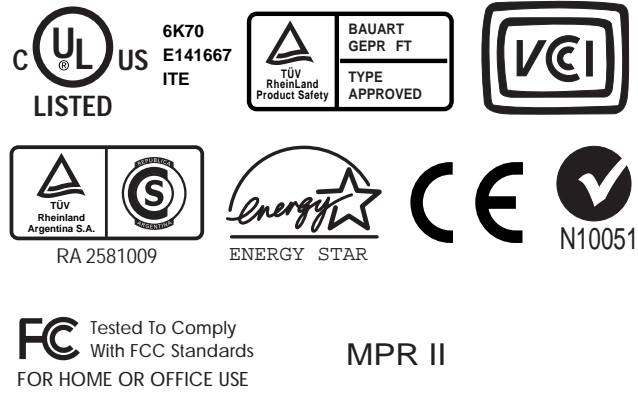

"This application of this monitor is restricted to special controlled luminous environment. This screen surface tend to reflect annoying light of lamps and sunlight. To avoid these reflections the monitor should not be positioned in front of a window or directed to luminaries. The monitor is in compliance with Reflection Class III according to ISO 9241-7.

WARRANTY

Except as otherwise stated herein or in an order acknowledgment delivered to Buyer, Seller warrants to Buyer that the Product shall be free of defects in materials and workmanship. The warranty for the touchmonitors and components of the product is 3 years.

Seller makes no warranty regarding the model life of components. Seller's suppliers may at any time and from time to time make changes in the components delivered as Products or components.

Buyer shall notify Seller in writing promptly (and in no case later than thirty (30) days after discovery) of the failure of any Product to conform to the warranty set forth above; shall describe in commercially reasonable detail in such notice the symptoms associated with such failure; and shall provide to Seller the opportunity to inspect such Products as installed, if possible. The notice must be received by Seller during the Warranty Period for such product, unless otherwise directed in writing by the Seller. Within thirty (30) days after submitting such notice, Buyer shall package the allegedly defective Product in its original shipping carton(s) or a functional equivalent and shall ship to Seller at Buyer's expense and risk.

Within a reasonable time after receipt of the allegedly defective Product and verification by Seller that the Product fails to meet the warranty set forth above, Seller shall correct such failure by, at Seller's options, either (i) modifying or repairing the Product or (ii) replacing the Product. Such modification, repair, or replacement and the return shipment of the Product with minimum insurance to Buyer shall be at Seller's expense. Buyer shall bear the risk of loss or damage in transit, and may insure the Product. Buyer shall reimburse Seller for transportation cost incurred for Product returned but not found by Seller to be defective. Modification or repair, of Products may, at Seller's option, take place either at Seller's facilities or at Buyer's premises. If Seller is unable to modify, repair, or replace a Product to conform to the warranty set forth above, then Seller shall, at Seller's option, either refund to Buyer or credit to Buyer's account the purchase price of the Product less depreciation calculated on a straight-line basis over Seller's stated Warranty Period.

THESE REMEDIES SHALL BE THE BUYER'S EXCLUSIVE REMEDIES FOR BREACH OF WARRANTY. EXCEPT FOR THE EXPRESS WARRANTY SET FORTH ABOVE, SELLER GRANTS NO OTHER WARRANTIES, EXPRESS OR IMPLIED BY STATUTE OR OTHERWISE, REGARDING THE PRODUCTS, THEIR FITNESS FOR ANY PURPOSE, THEIR QUALITY, THEIR MERCHANTABILITY, THEIR NON-INFRINGEMENT, OR OTHERWISE. NO EMPLOYEE OF SELLER OR ANY OTHER PARTY IS AUTHORIZED TO MAKE ANY WARRANTY FOR THE GOODS OTHER THAN THE WARRANTY SET FORTH HEREIN. SELLER'S LIABILITY UNDER THE WARRANTY SHALL BE LIMITED TO A REFUND OF THE PURCHASE PRICE OF THE PRODUCT. IN NO EVENT SHALL SELLER BE LIABLE FOR THE COST OF PROCUREMENT OR INSTALLATION OF SUBSTITUTE GOODS BY BUYER OR FOR ANY SPECIAL, CONSEQUENTIAL, INDIRECT, OR INCIDENTAL DAMAGES.

Buyer assumes the risk and agrees to indemnify Seller against and hold Seller harmless from all liability relating to (i) assessing the suitability for Buyer's intended use of the Products and of any system design or drawing and (ii) determining the compliance of Buyer's use of the Products with applicable laws, regulations, codes, and standards. Buyer retains and accepts full responsibility for all warranty and other claims relating to or arising from Buyer's products, which include or incorporate Products or components manufactured or supplied by Seller. Buyer is solely responsible for any and all representations and warranties regarding the Products made or authorized by Buyer. Buyer will indemnify Seller and hold Seller harmless from any liability, claims, loss, cost, or expenses (including reasonable attorney's fees) attributable to Buyer's products or representations or warranties concerning same.

INDEX

Numerics

- 17" LCD Touchmonitor (ET17X7L-XXWF-X) Dimensions, 38
- 17" LCD Touchmonitor (ET17X7L-XXWF-X) Specifications, 34

A

- About the Product, 1
- About Touchmonitor Adjustments, 23
- VESA Mounting Interface, 17
- AccuTouch Touchmonitor Specifications, 37
- Additional Color setting, 26
- Agencies, 34
- Analog Contrast, 25
- Analog Adjust, 26
- Attaching the L-Brackets, 5
- Auto Contrast, 25

B

- Back-light Lamp Life, 34
- Bottom View, 4
- Brightness, 25,26

C

- Care and Handling of Your Touchmonitor, 32
- Chemical Resistance, IntelliTouch, 36
- Cleaning Your Touchmonitor, 32
- Clock, 26
- Colors Temperature, 25
- Compatible Video Modes, 33
- Connecting the Power Cable, 15
- Connecting the OSD Remote Cable, 14
- Connecting the Serial or USB Touchscreen Cable, 13
- Connecting the Video Cable, 12
- Construction, AccuTouch, 37
- Contrast, 25
- Contrast Ratio, 34

D

- Display Brightness, 34
- Display Response Time, 34
- Display Type, 34
- DSUB Analog/DVI Digital, 26

E

- Electrical, 34
- Electrical Safety Information, 35
- Electrostatic Protection, IntelliTouch, 36
- Emissions and Immunity Information, 35
- Enable/Disable, 24
- Enter Select item, 24
- Environmental, 34, 36
- Expected Life Performance, AccuTouch, 37
- Expected Life Performance, IntelliTouch, 35

F

- Flesh Tone, 26

G

- Gloss, AccuTouch, 37
- Gloss, IntelliTouch, 35

H

- Haze, AccuTouch, 37
- Hue, 26

I

- Image Information, 27
- Image problem, 27
- Image, scrolling, 28
- Image, unstable, 28
- Image, vertical flickering, 28
- Installation and Setup, 3
- Installing the Driver Software, 18
- Installing the Serial Touch Driver, 19
- Installing the Serial Touch Driver for MS-DOS and Windows 3.1, 20
- Installing the Serial Touch Driver for Windows XP, 2000, Me, 95/98 and NT 4.0, 19
- Installing the USB Touch Driver, 21
- Installing the USB Touch Driver for Windows XP, 2000, Me and 98, 21
- IntelliTouch Touchmonitor Specifications, 35
- Introduction, 1

L

- Light Transmission, AccuTouch, 37
- Light Transmission, IntelliTouch, 35

M

- Main View, 4
- Mechanical, 34
- Mechanical, AccuTouch, 37
- Mechanical, IntelliTouch, 35
- Menu, 24
- Minus Counter-clockwise, 24

N

- Native Resolution, 29

O

- Operation, 23
- Optical, AccuTouch, 37
- Optical, IntelliTouch, 35
- Optimizing the LCD Display, 16
- OSD Left/Right, 26
- OSD Menu Function, 25

OSD Timeout, 26
OSD Up/Down, 26
OSD Power, Respond, 27
Out of Range display, 27

P

Panel Cut Outs, 6
Phase, 26
Pixel Format, 34
Positional Accuracy, AccuTouch, 37
Positional Accuracy, IntelliTouch, 35
Power Switch, 24
Precautions, 1
Product Overview, 4

R

Rear View, 4
Recall Defaults, 25
Regulatory Information, 41
Remote OSD Buttons, 24

S

Saturation, 26
Sealing, IntelliTouch, 35
Serial or USB Connection, 11
Side View, 38
Solutions to Common Problems, 27
Surface Durability, AccuTouch, 37
Surface Durability, IntelliTouch, 35
SVGA, 29
SXGA, 29

T

Technical Specifications, 33
Touch Activation Force, AccuTouch, 37
Touch Activation Force, IntelliTouch, 35
Touch Interface Connection, 11
Touch not working, 28
Touchmonitor Safety, 31
Touchmonitor Specifications, 34
Touchpoint Density, AccuTouch, 37
Touchpoint Density, IntelliTouch, 35
Troubleshooting, 27

U

Unpacking Your Touchmonitor, 3
Using the On-Screen Display (OSD) Menus, 23
UXGA, 29

V

VESA Mount on Your Touchmonitor, 16
VGA, 29
Viewing Angle, 34
Visual Resolution, AccuTouch, 37
Visual Resolution, IntelliTouch, 35

W

Warranty, 45

X

XGA, 29

Check out Elo's Web site!

www.elotouch.com

Get the latest...

• **Product information**

• **Specifications**

• **News on upcoming events**

• **Press releases**

• **Software drivers**

Getting in Touch with Elo

To find out more about Elo's extensive range of touch solutions, visit our Web site at www.elotouch.com or simply call the office nearest you:

USA & Headquarters

Elo TouchSystems, Inc.
301 Constitution Drive,
Menlo Park, CA 94025
USA

(800) ELO-TOUCH(800-356-8682)

Tel 650-361-4700

Fax 650-361-4747

eloinfo@elotouch.com

Germany

Elo TouchSystems GmbH & Co. KG
Haidgraben 6
D-85521 Ottobrunn
Germany

Tel +49(89)60822-0

Fax +49(89)60822-150

elosales@elotouch.com

Belgium

Elo TouchSystems
Diestsesteenweg 692
B-3010 Kessel-Lo 1-19-20
Belgium

Tel +32(16)35-2100

Fax +32(16)35-2101

elosales@elotouch.com

Japan

Touch Panel Systems K.K
Sun Homada Bldg. 2F
Shin-Yokohama
Kanagawa 222-0033
Japan

Tel +81(45)478-2161

Fax +81(45)478-2180

www.tps.co.jp

tyco

Electronics

