

RAMPAGE™

OWNER'S MANUAL AND INSTALLATION GUIDE

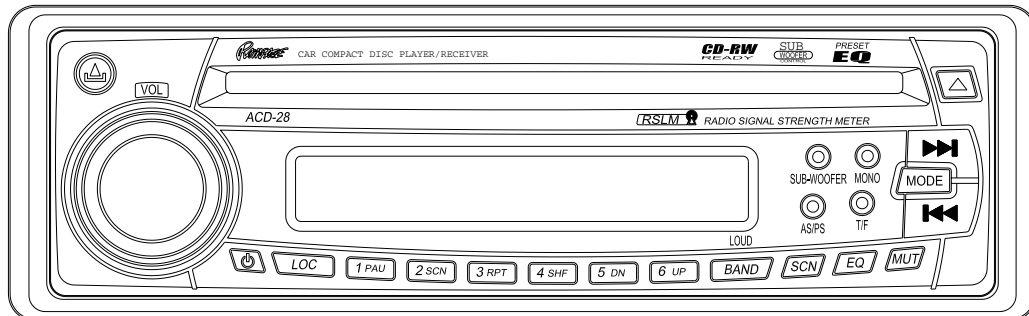

ACD-28

**AM/FM/MPX RADIO
WITH DETACHABLE FRONT PANEL
COMPACT DISC PLAYER,
CD CHANGER CONTROLS AND QUARTZ CLOCK**

INSTALLATION INSTRUCTIONS

This unit is designed for installation in cars, trucks, and vans with an existing radio opening. In many cases, a special installation kit will be required to mount the radio to the dashboard. These kits are available at electronics supply stores and car stereo specialist shops. Always check the kit application before purchasing to make sure the kit works with your vehicle. If you need a kit but cannot find it available, call our toll-free "HELP" line at 1-800-645-4994.

UNIVERSAL INSTALLATION PROCEDURE USING MOUNTING SLEEVE

1. Remove the detachable front panel if it is attached to the chassis by pushing the "Release" button. Slide the mounting sleeve off of the chassis. If it is locked into position, use the removal tools (supplied) to disengage it.
2. Check the dashboard opening size by sliding the mounting sleeve into it. If the opening is not large enough, carefully cut or file as necessary until the sleeve easily slides into the opening. Do not force the sleeve into the opening or cause it to bend or bow. Check that there will be sufficient space behind the dashboard for the radio chassis.
3. Locate the series of bend tabs along the top, bottom, and sides of the mounting sleeve. With the sleeve fully inserted into the dashboard opening, bend as many of the tabs outward as necessary so that the sleeve is firmly secured to the dashboard.
4. Place the radio in front of the dashboard opening so that the wiring can be brought through the mounting sleeve. Follow the wiring diagram carefully and make certain all connections of the wiring harness are secure and insulated with wire nuts or electrical tape to insure proper operation of the unit. After completing the wiring connections, attach the front panel and turn the unit on to confirm operation (ignition switch must be "on"). If unit does not operate, recheck all wiring until problem is corrected. Once proper operation is achieved, turn off the ignition switch and proceed with final mounting of the chassis.
5. Carefully slide the radio into the mounting sleeve making sure it is right-side-up until it is fully seated and the spring clips lock it into place.
6. Attach one end of the perforated support strap (supplied) to the screw stud on the rear of the chassis using the hex nut provided. Fasten the other end of the perforated strap to a secure part of the dashboard either above or below the radio using the screw and hex nut provided. Bend the strap to position it as necessary.

CAUTION: The rear of the radio must be supported with the strap to prevent damage to the dashboard from the weight of the radio or improper operation due to vibration.
7. Re-attach the front panel to the chassis and test radio operation by referring to the Operating Instructions for the unit.

INSTALLATION USING KITS

1. If your vehicle requires the use of an installation kit to mount this radio, follow the instructions included with the installation kit to attach the radio to the mounting plate supplied with the kit.
2. Wire and test the radio as described in Step 4 above.
3. Install the radio/mounting plate assembly to the sub-dashboard according to the instructions of the installation kit.
4. Attach the support strap to the radio and dashboard as described in Step 6 above.
5. Replace the dashboard trim panel.

ISO INSTALLATION PROCEDURE

This unit has threaded holes in the chassis side panels which may be used with the original factory mounting brackets of some Toyota, Nissan, Mitsubishi, Isuzu, Hyundai and Honda vehicles to mount the radio to the dashboard. Please consult with your local car stereo specialist shop for assistance on this type of installation.

1. Remove the existing factory radio from its dashboard or center console mounting. Save all hardware and brackets as they will be used to mount the new radio.
2. Carefully unsnap the plastic frame from the front of the new radio chassis. Remove and discard the frame.
3. Remove the factory mounting brackets and hardware from the existing radio and attach them to the new radio.

CAUTION: DO NOT EXCEED M5X8MM MAXIMUM SCREW SIZE. LONGER SCREWS MAY TOUCH AND DAMAGE COMPONENTS INSIDE THE CHASSIS.
4. Wire the new radio to the vehicle as per step 4 of the Universal Installation Procedure.
5. Mount the new radio assembly to the dashboard or center console using the reverse procedure of step 1.

TOLL-FREE INSTALLATION ASSISTANCE

The installation and wiring connections for this unit are so simple, we doubt you'll need our help, but, if you do, we're here to help you. Just call our toll-free telephone assistance line at **1-800-645-4994** during the days and hours shown (U.S.A. and Canada only).

DAY	TIME ZONE			
	PACIFIC	MOUNTAIN	CENTRAL	EASTERN
MON. - FRI.	5:30AM - 4PM	6:30AM - 5PM	7:30AM - 6PM	8:30AM - 7PM
SATURDAY	6AM - 2PM	7AM - 3PM	8AM - 4PM	9AM - 5PM

UNIVERSAL INSTALLATION USING MOUNTING SLEEVE

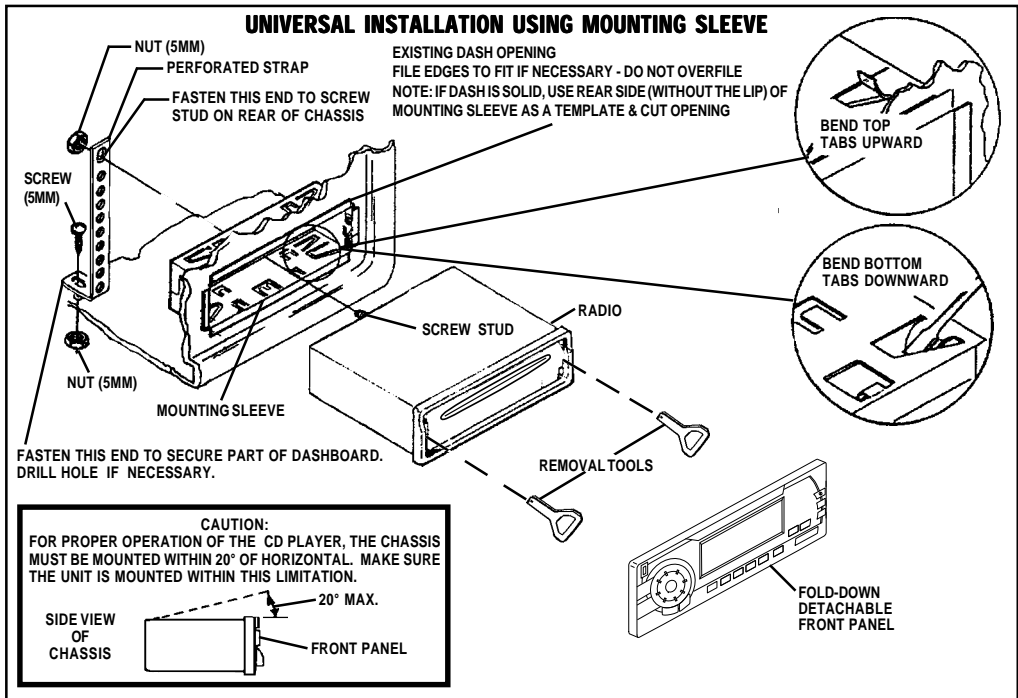

ISO INSTALLATION

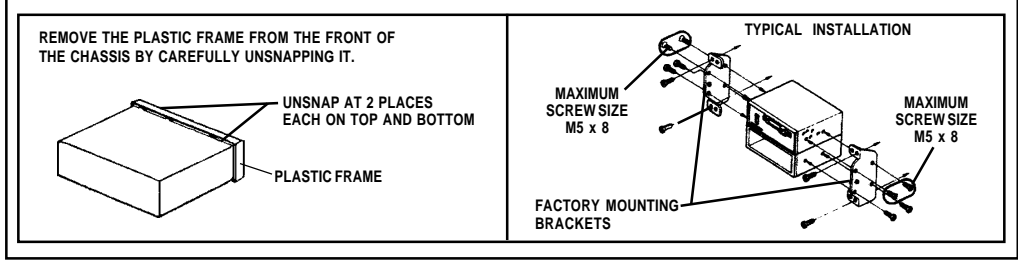

RADIO WIRING

REFER TO PAGE 5 FOR SPEAKER WIRING

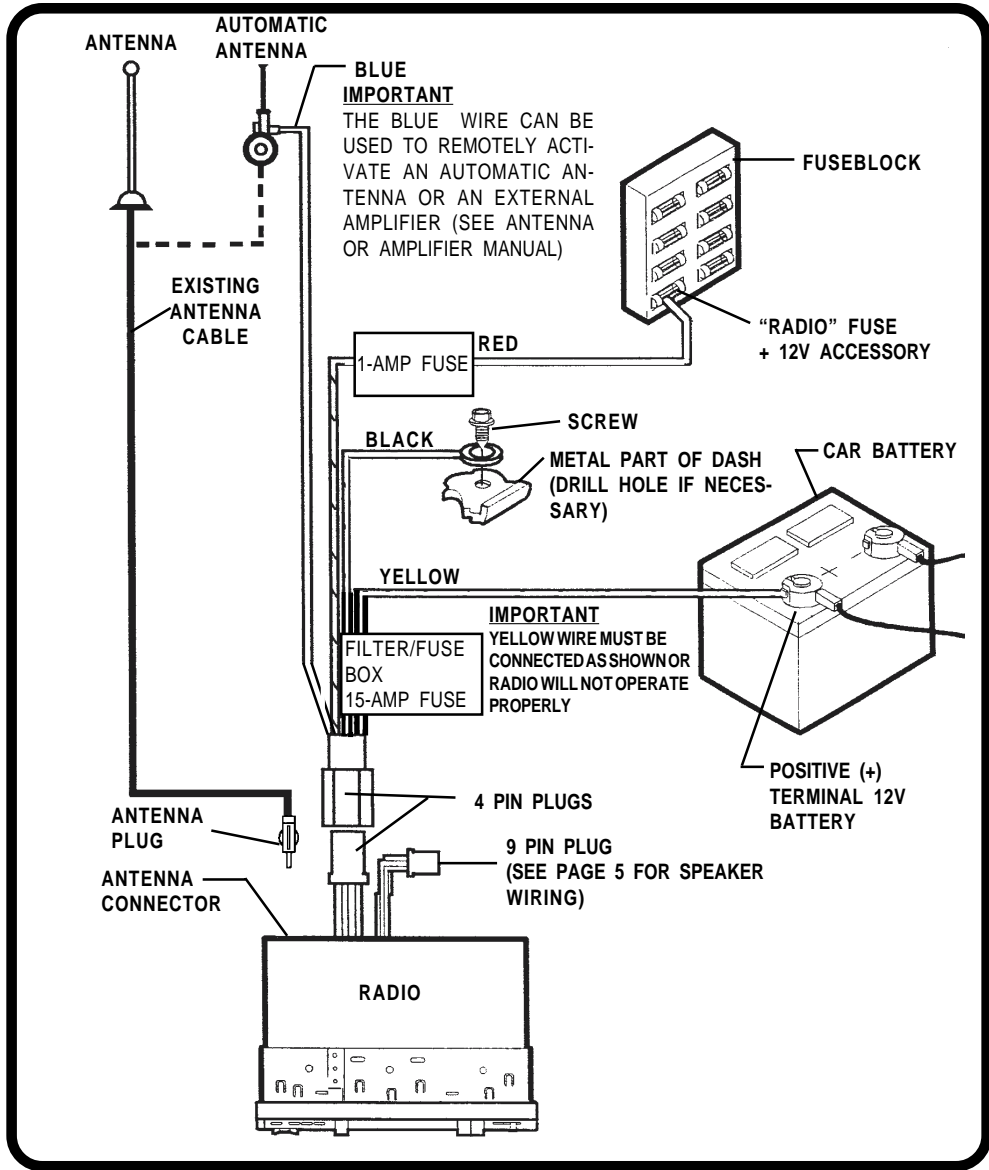

SPEAKER WIRING

REFER TO PAGE 4 FOR RADIO WIRING

WARNING!

- THE AMPLIFIERS IN THIS RADIO ARE **ONLY** DESIGNED FOR USE WITH 4 SPEAKERS.
- **NEVER** COMBINE (BRIDGE) OUTPUTS FOR USE WITH 2 SPEAKERS.
- **NEVER** GROUND NEGATIVE SPEAKER LEADS TO CHASSIS GROUND.
- FAILURE TO WIRE EXACTLY AS SHOWN BELOW MAY CAUSE ELECTRICAL DAMAGE TO THE RADIO.

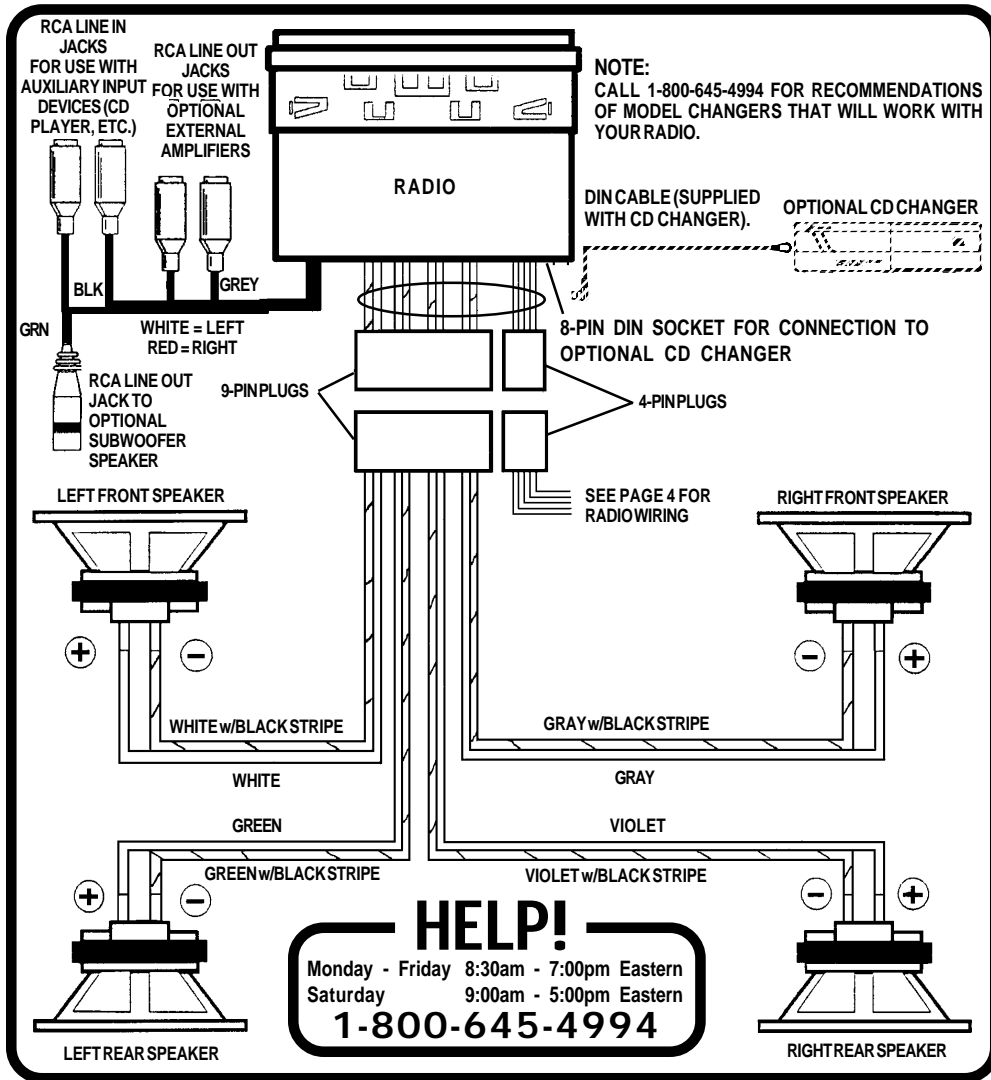

OPERATING INSTRUCTIONS

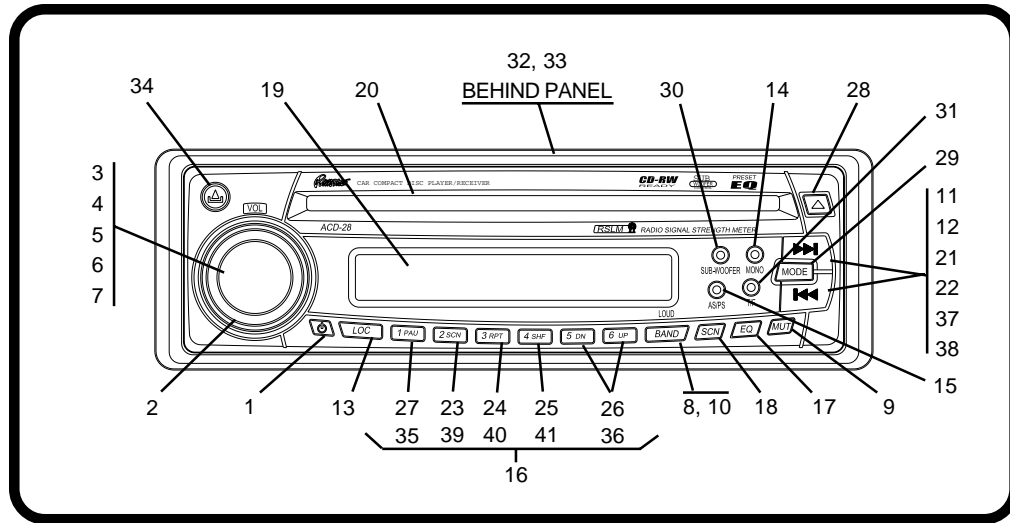

① ON-OFF POWER BUTTON

Press this button to turn the unit on and off when the ignition switch is on. When the unit is off, the Liquid Crystal Display (LCD) panel will normally display the time-of-day. If the radio is off when the ignition switch is turned off, the POWER button must be pressed to turn on the radio after the ignition switch is turned on. If the ignition switch is turned off while the radio is on, the radio will come on automatically when the ignition switch is again turned on.

② VOLUME LEVEL CONTROL

To increase the volume level, rotate the PUSH SELECT-VOL control clockwise (CW). The volume will increase and the level will be shown on the display panel from a minimum of **00** to a maximum of **100**. To decrease the volume level, rotate the PUSH SELECT-VOL control counterclockwise (CCW). The volume will decrease as shown on the display panel. This control also includes the integral Select button ③ for adjustment of the bass, treble, balance and fader levels as

described in ④, ⑤, ⑥, and ⑦.

③ PUSH SELECT BUTTON (SEL)

This button is used to select the audio function (bass, treble, balance, or fade) to be adjusted using the Volume Level control ②. Pressing the Select button once will set the unit for volume adjustment (**VOL** will appear on the display panel). Pressing the button additional times will select bass adjustment (**BAS** on display), treble (**TRB**), balance (**BAL**), or fader (**FAD**). The display will automatically return to the normal indication 5 seconds after the last adjustment or when another function is activated.

NOTE: If the BAS or TRB functions are set while the Equalizer function (EQ) is active, the Equalizer function will automatically revert to the **FLAT** setting.

④ BASS CONTROL

To adjust the bass level, first select the Bass mode by pressing the PUSH SELECT button ③ so the **BAS** indication appears on the display panel. Within 5 seconds of choosing the Bass mode, rotate the Volume Level control ② CCW or

CW to adjust the bass response as desired. The level will be shown on the display panel from a minimum **--10** to a maximum of **10** (**00** indicates flat response). The display will automatically return to the normal indication 5 seconds after the last adjustment or when another function is activated.

⑤ TREBLE CONTROL

To adjust the treble level, first select the Treble mode by pressing the PUSH SELECT button ③ so the **TRB** indication appears on the display panel. Within 5 seconds of choosing the Treble mode, rotate the Volume Level control ② CCW or CW to adjust the treble response as desired. The level will be shown on the display panel from a minimum of **--10** to a maximum of **10** (**00** indicates flat response). The display will automatically return to the normal indication 5 seconds after the last adjustment or when another function is activated.

⑥ LEFT/RIGHT BALANCE CONTROL

To adjust the left-right speaker balance, first select the Balance mode by pressing the PUSH SELECT button ③ so the **BAL** indication appears on the display panel. Within 5 seconds of choosing the Balance mode, rotate the Volume Level control ② CCW to adjust the stereo balance to the left channel speakers, or CW to adjust it to the right channel speakers. The balance position will be shown on the display panel from **BAL 10L** (full left) to **BAL 10R** (full right). When the volume level between the left and right speakers is equal, **BAL L=R** will be shown on the display panel. The display will automatically return to the normal indication 5 seconds after the last adjustment or when another function is activated.

⑦ FRONT/REAR FADER CONTROL

To adjust the front-rear speaker balance, first select the Fader mode by pressing the PUSH SELECT button ③ so the **FAD** indication appears on the display panel. Within 5 seconds of choosing the Fader mode, rotate the Volume Level control ② CCW or CW to adjust the front-rear speaker balance as desired. The fader position will be shown on the display panel from **FAD 10R** (full rear) to **FAD**

10F (full front). When the level between the front and rear speakers is equal, **FAD F=R** will be shown on the display panel. The display will automatically return to the normal indication 5 seconds after the last adjustment or when another function is activated.

⑧ LOUDNESS CONTOUR (BAND/LOUD)

When listening to music at low volume levels, this feature will boost the bass and treble ranges to compensate for the characteristics of human hearing. Press the **BAND/LOUD** button for 2 seconds to activate this feature and the indication **LOUD ON** will appear on the display panel for 5 seconds. Pressing the button again for 2 seconds will deactivate the feature, and **LOUD OFF** will appear on the display panel for 5 seconds.

⑨ AUDIO MUTE SELECTOR (MUT)

Press this button momentarily to mute the volume from the system (**MUTE** will appear flashing on the display panel). Pressing this button again, adjusting the Volume Level control ②, or pressing any other button, will return to the volume level setting in use before the Mute function was activated.

⑩ AM/FM BAND SELECTOR (BAND/LOUD)

Each time the **BAND/LOUD** button is pressed, the radio band is changed. The indications **F1**, **F2**, **F3** or **AM** will appear in the display panel according to your selection.

⑪ AUTOMATIC UP/DOWN TUNING

(▶▶/◀◀)

To select a radio station in the automatic mode, momentarily press the Up Tuning (▶▶) button to advance the unit to the next available station, or the Down Tuning (◀◀) button to tune downward to the next available station. The radio will automatically seek the next strongest station. If the Local mode (**LOCAL**) is active, the radio will seek the next strongest local station when either button is pressed.

12 MANUAL SEEK TUNING

This function is used to search rapidly upward or downward for a desired station. By pressing either tune button for more than 2 seconds, the radio will enter the **MANUAL** seek mode as displayed momentarily on the panel. When either button is pressed and held in this mode, the radio will tune rapidly up or down and will stop at the station of choice when the button is released. A momentary press of either button in this mode will cause the radio to tune upward or downward two digits at a time. If tuning is not activated within 5 seconds of entering the **MANUAL** mode, the radio will automatically revert to the default **AUTO** mode as indicated momentarily on the panel.

13 LOCAL/DISTANT SELECTOR (LOC)

This feature is used to select the strength of the signals at which the radio will stop during Automatic Up/Down Tuning. Pressing the button will select the Local setting (**LOCAL** will appear on the display panel for 5 seconds) and tuning will select only strong (local) stations for reception. Pressing the button again will select the Distant setting (**DX** will appear on the display panel for 5 seconds) and the tuning will stop at a wider range of signals, including weaker (more distant) stations.

14 FM MONO SELECTOR (MONO)

During FM radio operation, this button is used to select mono or stereo reception of the broadcast signal. Under normal reception conditions, the unit should be left in the stereo mode as indicated by **ST** and the associated signal strength indicator on the display panel when tuned to an FM stereo signal. If the stereo signal is too noisy for comfortable listening, press the **MONO** button to switch to mono reception (the **ST** indication will disappear from the display panel). To return to stereo reception mode, press the button again; the **ST** indication is displayed.

15 AUTO STORE/PRESET SCAN (AS/PS)

Press this button momentarily to scan the stations pre-set into the memory on the 3 FM bands or the AM band. The unit will stop at each pre-set station for 5 seconds before continuing to the next pre-set station (the pre-set number on the display panel will flash during Pre-Set Scan operation). Press the button again momentarily to stop Pre-Set Scan operation and remain on the selected frequency.

Pressing and holding the button for longer than 2 seconds will activate the Auto-Store Tuning feature which will automatically scan and enter up to 6 stations into the 6 pre-set memories on each of the FM bands, or the AM band in use. After entering the stations into the memories, the unit will automatically stop at each station for 5 seconds so each can be heard. If you have already set the pre-set memories to your favorite stations, activating the Auto-Store Tuning feature will erase those stations and enter the new ones. This feature is most useful when travelling in a new area where you are not familiar with the local stations.

16 STATION PRE-SET MEMORIES

To set any of the 6 pre-set memories in each band, use the following procedure:

1. Turn the radio on and select the desired band.
2. Select the first station to be pre-set using the Automatic Up/Down (11), or Manual Seek (12) Tuning Controls.
3. Press the pre-set button to be set and continue to hold it in for approximately 2 seconds. The pre-set number will appear on the display panel indicating that the station is now set into that pre-set memory position. The station can now be recalled at any time by pressing that button.
4. Repeat the above procedure for the remaining 5 pre-sets on that band and for the other 3 bands on the unit.

17 EQUALIZER (EQ) BUTTON

The *EQ* button applies preset sound effects to the unit's audio output signal. The *EQ* button, when pressed, will activate one of the following operating modes (**CLASSICS, POP M, ROCK M, DSP OFF or FLAT**). If the Equalizer function is active, as displayed on the panel, and the bass and/or treble level is set, the Equalizer function reverts to the **FLAT** setting. On the other hand, if the Equalizer function is activated, the bass/treble setting(s) are ignored. Conversely, when the Equalizer function is not active, the unit returns to the user set bass and treble levels.

18 STATION SCAN (SCM) BUTTON

When this button is pressed during radio operation, each station in the current band will be scanned in the upward direction; each displayed station will flash for 5 seconds before moving on to the next station. If the local mode is active, only the stronger, nearby stations in the current band will be scanned. When the desired station appears, press the *SCN* button again to remain on that frequency.

19 LIQUID CRYSTAL DISPLAY PANEL

The Liquid Crystal Display (LCD) panel displays the frequency, time and activated functions, including a combination audio level/disc indicator in the form of dual disc icons () with circular bar graphs depicting the the audio signal. In addition, the display also contains a receive signal indicator which depicts the relative strength of the incoming broadcast frequency.



NOTE: It is a characteristic of LCD panels that, if subjected to cold temperatures for an extended period of time, they may take longer to illuminate than under normal conditions. In addition, the visibility of the numbers on the LCD may slightly decrease. The LCD read-out will return to normal when the temperature increases to a normal range.

20 DISC SLOT



Gently insert the disc into the slot (label surface facing up) until the soft-loading mechanism engages and pulls the disc in. The **S--CDP** indication will appear on the display panel for 5 seconds, the center of the disc () indication illuminates and becomes animated, and the track number and elapsed time appear on the display panel.

CAUTION: This unit is designed for play of standard 5" (12cm) compact discs ONLY. Do not attempt to use 3" (8cm) CD-Singles in this unit, either with or without an adapter, as damage to the player and/or disc can occur. Such damage will not be covered by the Warranty on this product.

21 TRACK SELECT ( / )

The Track Select function of the Tune/Seek/Track buttons is used to quickly access the beginning of a particular track when a disc is in play. Each time the Forward Track Select () button is pressed, the next higher track number will be selected as shown on the display panel. Similarly, each time the Backward Track Select () is pressed, the next lower track number will be selected as shown on the display panel.

22 CUE/REVIEW FUNCTIONS ( / )

High-speed audible search to any section of the disc can be made by the Cue and Review functions. Press and hold the Cue () button to advance rapidly in the forward direction (the advancing disc playing time will be shown on the display panel, except for discs formatted with MP3 audio), or the Review () button to advance rapidly in the backward direction (the decreasing disc playing time will be shown on the display panel).

23 TRACK SCAN SELECTOR (SCN)

During disc play, press this button to play the first 10 seconds of each track on the disc (**S--SCN** will appear on the display panel). When a desired track is reached, press the SCN button again to cancel the function (**S--SCN** will disappear from the display panel) and play of the selected track will continue. Scan mode will also be canceled by activating the Repeat Play **24**, or Shuffle Play **25** functions.

24 REPEAT PLAY SELECTOR (RPT)

During disc play, press this button to repeat the play of the selected track (**S--RPT** will appear on the display panel). Play of the track will continue to repeat until the button is pressed again and the **S--RPT** indication disappears from the display panel. Repeat Play mode will also be canceled by activating the Track Scan **23** or Shuffle Play **25** functions.

25 SHUFFLE PLAY SELECTOR (SHF)

During disc play, press this button to play the tracks on the disc in a random shuffled order (**S--SHF** will appear on the display panel). In Shuffle Play mode, the TRACK Select function will also select tracks in random order instead of the normal progression. The Shuffle Play mode can be canceled by pressing the button again (**S--SHF** indication will disappear from the display panel) or by activating the Repeat Play **24** or Track Scan **23** functions.

26 DISC SELECT UP/DOWN (UP/DN)

These buttons are used to select the desired disc for play during changer operation. To advance to a higher number disc, press the *UP* button, and to return to a lower number disc, press the *DN* button. The number of the disc in play will be shown on the display panel.

27 DISC PAUSE (PAU)

When this button is pressed during disc play, **S--PAUSE** will appear on the display, and

disc play will be suspended; the center of the

disc icon () will stop rotating, indicating disc pause. When the button is pressed again, **S--PAUSE** will disappear from the display and play will resume from the point at which pause occurred.

28 DISC EJECT (▲)

Disc play is stopped and the disc is ejected when this button is pressed. Radio or CD changer operation will automatically resume depending on which mode was in operation prior to disc play. If the disc is not removed from the unit within 15 seconds of being ejected, it will automatically be re-loaded into the unit to prevent it from being accidentally damaged ( will appear on the display panel to indicate that a disc is loaded in the player). Play of the disc can be resumed by using the MODE button **29** to choose the CD player function.

29 MODE SELECTOR (MODE)

During radio or tape play, press this button to select operation of the optional CD changer as shown by **CDC**, the disc number and the track number on the display panel. Refer to the CD Changer Controls section for specific operating instructions.

If the button is pressed when no CD changer is connected to the unit, no CDC indications will appear on the display panel. The unit will then return to radio operation. To return to the disc play operation (if a compact disc is loaded in the unit), press the button again. During disc play, press this button to change to radio operation without ejecting the disc.

30 SUB-WOOFER SELECT

When the SUB-WOOFER button is pressed, the sub-woofer audio output, via the single RCA connector on the green wire, is made available to an optional sub-woofer speaker, if installed in the vehicle.

31 TIME/FREQUENCY SELECTOR (T/F)

Pressing the Time/Frequency (T/F) button will display the time of day for 5 seconds, after which the display will automatically return to the radio, tape or CD changer display, depending on which one was currently active.

To set the correct time of day, refer to the procedure for Setting the Clock.

32 THEFT-DETERRENT LED

Located on the chassis behind the front panel, a light-emitting diode (LED) will flash when the panel is removed. The flashing light serves as a visual warning to the would-be thief that the unit has been disabled by removal of the front panel.

33 RESET BUTTON

A RESET button is located on the front of the chassis (front panel must be removed to access the button). The reset circuitry is provided to protect the microprocessor circuitry and should only be activated under the following circumstances as it will erase the time and pre-set memories.

1. Upon initial installation after all wiring is completed.
3. If there is a malfunction of any of the switches on the unit, pressing the RESET button may clear the system and return to normal operation.

34 FRONT PANEL RELEASE BUTTON

This button is used to release the mechanism that holds the front panel to the chassis. To detach the front panel, press the button so that the left side of the panel is released. Grasp the released side and pull it off of the chassis. To re-attach the panel, position the right side of the panel in place first and then press the left side of the panel until the mechanism locks it into place.

NOTES ON USE OF FRONT PANEL

1. Make sure the front panel is right-side-up when attaching it to the chassis as it cannot be attached when up-side down.
2. Do not press very hard on the front panel when attaching it to the chassis. No more than light to moderate pressure should be needed.
3. When attaching the front panel, make sure the right side is correctly engaged before pressing the left side to lock it into position.
4. When taking the front panel with you, please use the supplied carrying case to protect the panel from dirt and damage. Make sure there is no dust or dirt on the electrical terminals on the back of the panel as this could cause intermittent operation or other malfunctions.

DETACHING THE FRONT PANEL

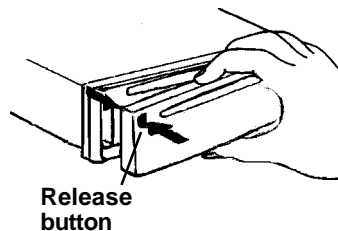

ATTACHING THE FRONT PANEL

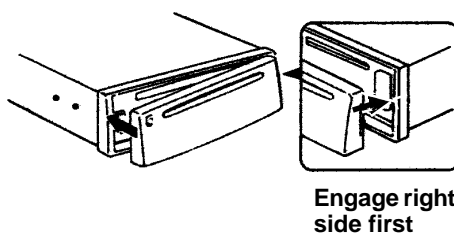

SETTING THE CLOCK

1. Switch the vehicle ignition and radio on.
2. Momentarily press the Time/Frequency (T/F) Select button **(31)** so that the time is shown on the display panel.
3. Press and hold the Time/Frequency button until the time display begins flashing. While the display is still flashing, press the Up Tuning (**▶▶**) button to adjust the hours and the **A** or **P** indication, then the Down Tuning (**◀◀**) button to adjust the minutes to the correct time.
4. Five seconds after the last hour or minute adjustment is made, the time will be set in the unit and the display will return to the normal indication.

CD PLAYER ERROR CODES

If a problem should develop while operating the CD player, an error code (**ER-1**, **ER-2**, **ER-3**, etc.) may appear on the display panel. This can indicate a number of problems with the unit, including a mechanical error or an error in the microprocessor control of the player. If an error code should appear, try ejecting and re-loading the disc into the player. While the disc is out of the unit, make sure it is clean, undamaged, and loaded correctly (label surface up). You may also try activating the RESET button **(3)** on the unit, but this will also erase the time and pre-set memories.

If the suggested measures do not solve the problem, contact an approved warranty station near you for further assistance.

SPECIFICATIONS

Size:	7" W x 2" H x 6" D 178 mm x 50 mm x 150 mm
Operating Voltage:	12 volts DC, negative ground
Output Power:	160 watts maximum (40 watts x 4 channels)
Output Wiring:	Floating-ground type designed for 4 speaker use. The amplifiers in this unit are NOT designed for use with 2 speakers. RCA pre-amp level outputs.
Output Impedance:	Compatible with 4 - 8 ohm speakers
Pre-Amp Output:	500 mv.
Tuning Range:	AM: 530 - 1,710 KHz. (10 KHz. step) FM: 87.5 - 107.9 MHz. (200 KHz. step)
Sensitivity:	AM: >45 dB. FM: >15 dB at a S/N of 30 dB
FM Stereo Separation:	25 dB at 1kHz
CD Frequency Response:	5 – 20 kHz. +0/-3 dB
CD Signal/Noise Ratio:	>70 dB
CD Channel Separation:	>60 dB
CD Distortion:	0.2%

*Specifications are subject to change without notice.

NOTES ON DISCS:

Attempting to use non-standard shape discs (e.g.; square, star, heart) may damage the unit. Be sure to use round-shape CDs only in this unit.

NOTES ON CD-Rs (Recordable CDs)/CD-RWs (Rewriteable CDs):

1. Be sure to use discs with the following marks only for play in this unit:
2. The unit cannot play a CD-R or CD-RW that is not finalized. (Please refer to the manual of your CD-R/CD-RW software for more information on the finalization process.)
3. Depending on the recording status, conditions of the disc and the equipment used for the recording, some CD-Rs/CD-RWs may not be played on this unit.

RELIABLE PLAYBACK:

To ensure more reliable playback, please note the following recommendations:

1. Use CD-RWs with speed 1x to 4x.
2. Use CD-Rs with speed 1x to 8x, and write with speed 1x to 2x.
3. Do not play a CD-RW which has been written on more than 5 times.

NOTES ON MULTI-SESSION DISCS:

If the first track of the first session is audio CD data, then the unit will play only the audio CD data.

CD CHANGER CONTROLS

Built into this radio are controls to operate an optional CD changer. Please check with your Rampage/Audiovox car stereo specialist for recommendations of the models that will work with this radio.

Once the changer is installed and properly connected, it may be necessary to press the RESET button behind the radio front panel to initialize the complete installation.

Adjustment of the audio functions (volume, tone, balance, and fader) for the CD changer operate in the same manner as they do for radio play. The following controls will operate the CD changer when it is installed and connected to this radio. Refer to the owner's manual included with the CD changer for instructions on the installation and correct loading and use of the CD magazine.

35 CD CHANGER PAUSE/PLAY SELECTOR (PAU)

During radio, or tape play, press the MODE button (29) to select operation of the CD changer as shown by CDC on the display. Disc play will begin, the disc and track number will be shown on the display panel, and the center of the disc icon () will become animated. If a new magazine has been loaded into the changer, play will begin from the first track of the first disc in the magazine. If a magazine was already in the changer, play will resume from the track on the disc previously in play.

During CD changer play, pressing the PAU button once will stop changer play; PAUSE will appear on the display and the center of the disc icon will remain stationary. To resume disc play, press the PAU button again and disc play will resume from the point at which it was interrupted.

36 DISC SELECT (UP/DN)

These buttons are used to select the desired disc for play. To advance to a higher number

disc, press the UP button. To return to a lower number disc, press the DN button. The number of the disc in play will be shown on the display panel.

37 TRACK SELECT (▶▶/◀◀)

This button is used to quickly select the beginning of a particular track. With each momentary press of the Forward Track Select button (▶▶), the next higher track number will be selected as shown on the display panel. Similarly, with each momentary press of the Backward Track Select button (◀◀), the next lower track number will be selected.

38 FOWARD/REVERSE SEARCH (CUE/REVIEW)

High-speed audible search to any forward or reverse section of the disc can be made with this feature. Press and hold the forward (cue) button (▶▶) to advance rapidly in the forward direction, or press and hold the reverse (review) button (◀◀) to advance rapidly in the reverse (backward) direction. In either case, the center of the disc icon will rotate faster when search is active.

39 TRACK SCAN SELECTOR (SCN)

When the SCN button is momentarily pressed, the SCN indication will appear on the display panel, and the first 10 seconds of each track on the disc will be played in order. When a desired track is reached, press the SCN button again and play of the selected track will continue (SCN will disappear from the display panel). The Track Scan mode will also be canceled by activating any other disc function (Track Select, Repeat or Random).

When the SCN button is pressed and held for more than 2 seconds, the disc scan mode is activated; DSN will appear on the display and the first 10 seconds of the first track on each disc will be played in disc order. This mode is canceled in the same manner as before.

40 TRACK REPEAT PLAY SELECTOR (RPT)

When the *RPT* button is momentarily pressed, the **RPT** indication will appear on the display panel and play of the current track will be continually repeated until the Track Repeat mode is canceled by pressing the *RPT* button again or by activating the Track Select, Random Play or Scan functions.

When the *RPT* button is pressed and held for more than 2 seconds, the disc repeat mode is activated; **DRT** will appear on the display and the play of the current disc will be continuously repeated. This mode is canceled in the same manner as before.

41 SHUFFLE PLAY SELECTOR (SHF)

When the *SHF* button is momentarily pressed, the **SHF** indication will appear on the display panel and the tracks on the disc will be played in a random, shuffled order. The Track Select buttons **47** will also select tracks in the shuffled order instead of the normal progression. The Track Shuffle mode can be canceled by pressing the *SHF* button again or by activating the Track Select, Repeat Play or Scan functions.

When the *SHF* button is pressed and held for more than 2 seconds, the disc shuffle mode is activated; **DSF** will appear on the display and the play of the discs in the magazine will be played in a random shuffled order. This mode is canceled in the same manner as before.

CD CHANGER ERROR CODES

If a problem should develop while operating the CD changer, the following error codes may appear on the display panel.

- ER-1:** Indicates that there is no magazine loaded in the CD changer.
- ER-2:** Indicates a problem with the magazine eject function.
- ER-3:** Indicates an error in the disc loading function.
- ER-4:** Indicates an error in the disc un-loading function.
- ER-5:** Indicates an error in the magazine position.
- ER-6:** Indicates an error in the laser pick-up position.
- ER-7:** Indicates an error in the laser focus on the disc.

In any of the above situations, try ejecting the CD magazine from the changer and make sure the discs are clean, undamaged, and loaded correctly (refer to the Owner's Manual of the CD changer). Re-load the magazine and check for proper operation. You may also try activating the **RESET** button **43** on the unit, but this will also erase the time and pre-set memories.

If the suggested measures do not solve the problem, contact an approved warranty station near you for further assistance.

CARE AND MAINTENANCE

The radio section of your new sound system does not require any maintenance. We recommend you keep this manual for reference on the many features found in this unit as well as how to set the clock. The compact disc player section also requires no routine maintenance, but proper understanding of its use and handling will help you obtain maximum enjoyment of its capabilities. The following points should be observed:

THIS PAGE LEFT BLANK INTENTIONALLY

- When cleaning the interior of the vehicle, do not get water or cleaning fluids on the unit.
- The CD player is a precision instrument and will not operate properly in extreme hot or cold. In case of such conditions, wait until the interior temperature of the vehicle reaches a normal temperature before using the player.
- If the temperature inside the player gets too hot, a protective circuit will automatically stop play of the disc. In this case, allow the unit to cool off before operating the player again.
- Never insert anything other than a 5" (12 cm) compact disc into the player as the mechanism can be damaged by foreign objects.
- Do not attempt to use 3" (8 cm) CD-Single discs in this unit, either with or without an adaptor, as damage to the player and/or disc may occur. Such damage will not be covered by the Warranty on this product.
- When not using the disc player, always remove the compact disc.
- When the vehicle warms up during cold weather or under damp conditions, moisture may condense on the lens of the disc player. Should this occur, the player will not operate properly until the moisture has evaporated.
- The unit is designed with a vibration dampening CD mechanism to minimize interruption of disc play due to normal vibration in a moving vehicle. When driving on very rough roads, however, occasional sound skips may occur. This will not scratch or damage the disc and normal play will resume when the rough conditions cease.

HANDLING COMPACT DISCS

Dirt, dust, scratches, and warpage can cause skips in the playback and deterioration of sound quality. Please follow these guidelines to take care of your compact discs:



- Use only compact discs with the mark:
- Fingerprints, dust, and dirt should be carefully wiped off the disc's playing surface (shiny side) with a soft cloth. Wipe in a straight motion from the inside to the outside of the disc.
- Never use chemicals such as record sprays, household cleaners or thinner to clean compact discs. Such chemicals can irreparably damage the disc's surface.
- Discs should be kept in their storage cases when not in use.
- Do not expose discs to direct sunlight, high temperatures or high humidity for extended periods.
- Do not stick paper, tape, or labels on the disc surfaces nor write on them with any type of marker.

12 MONTH LIMITED WARRANTY

AUDIOVOX ELECTRONICS CORPORATION (the Company) warrants to the original retail purchaser of this product that should this product or any part thereof, under normal use and conditions, be proven defective in material or workmanship within 12 months from the date of original purchase, such defect(s) will be repaired or replaced with new or reconditioned product (at the Company's option) without charge for parts and repair labor.

To obtain repair or replacement within the terms of this Warranty, the product is to be delivered with proof of warranty coverage (e.g. dated bill of sale), specification of defect(s), transportation prepaid, to the warranty center at the address shown below.

This Warranty does not extend to the elimination of car static or motor noise, to correction of antenna problems, to costs incurred for installation, removal, or reinstallation of the product, or damage to tapes, compact discs, speakers, accessories, or vehicle electrical systems.

This Warranty does not apply to any product or part thereof which, in the opinion of the Company, has suffered or been damaged through alteration, improper installation, mishandling, misuse, neglect, accident, or by removal or defacement of the factory serial number/bar code label(s). THE EXTENT OF THE COMPANY'S LIABILITY UNDER THIS WARRANTY IS LIMITED TO THE REPAIR OR REPLACEMENT PROVIDED ABOVE AND, IN NO EVENT, SHALL THE COMPANY'S LIABILITY EXCEED THE PURCHASE PRICE PAID BY PURCHASER FOR THE PRODUCT.

This Warranty is in lieu of all other express warranties or liabilities. ANY IMPLIED WARRANTIES, INCLUDING ANY IMPLIED WARRANTY OF MERCHANTABILITY, SHALL BE LIMITED TO THE DURATION OF THIS WRITTEN WARRANTY. ANY ACTION FOR BREACH OF ANY WARRANTY HEREUNDER INCLUDING ANY IMPLIED WARRANTY OF MERCHANTABILITY MUST BE BROUGHT WITHIN A PERIOD OF 30 MONTHS FROM DATE OF ORIGINAL PURCHASE. IN NO CASE SHALL THE COMPANY BE LIABLE FOR ANY CONSEQUENTIAL OR INCIDENTAL DAMAGES FOR BREACH OF THIS OR ANY OTHER WARRANTY, EXPRESS OR IMPLIED, WHATSOEVER. No person or representative is authorized to assume for the Company any liability other than expressed herein in connection with the sale of this product.

Some states do not allow limitations on how long an implied warranty lasts or the exclusion or limitation of incidental or consequential damage so the above limitations or exclusions may not apply to you. This Warranty gives you specific legal rights and you may also have other rights which vary from state to state.

USA: AUDIOVOX ELECTRONICS CORPORATION, 150 MARCUS BLVD., HAUPPAUGE, NY 11788 1-800-645-4994

CANADA: CALL 1-800-645-4994 FOR LOCATION OF WARRANTY STATION SERVING YOUR AREA

128-4270A



For Customer Service
Visit Our Website At
www.audiovox.com
Product Information, Photos,
FAQ's, Owner's Manuals