

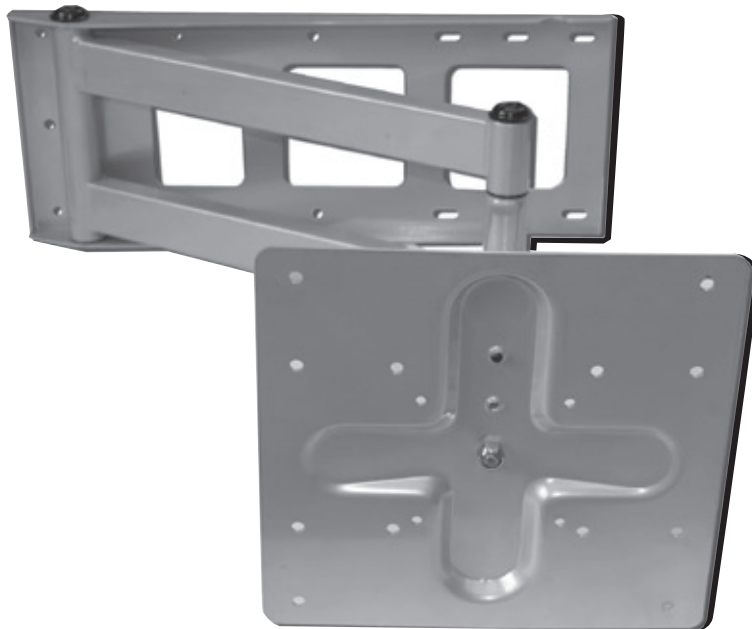

**QUALITY MOUNTING SOLUTIONS
STEP-BY-STEP INSTALLATION MANUAL
K2-A3-S ARTICULATING MOUNT**



K2-A3-S Installation Instructions & Manual

Table of Contents

| | |
|--|---|
| Before You Begin | 1 |
| What You Will Need | 1 |
| Package Contents | 2 |
| Installation | 3 |
| Wood Stud Wall Installation | 3 |
| Concrete or Concrete Block Wall Installation | 4 |
| Specifications | 6 |
| K2Mounts Warranty | 7 |

Before You Begin



Read this entire manual! Do not attempt to install this product if you do not understand the instructions or if there are missing or defective parts. If you are in doubt, contact a qualified contractor to install the mounting bracket. Improper installation may result in damage to the screen, property, or personal injury.

What You Will Need

You will need these tools to install your wall mount bracket:

- Measuring tape
- Level
- Pencil or pen
- Electric drill
- Hammer
- Ratchet with 7/16 inch socket
- Phillips screwdriver
- Stud finder (for wood stud wall)
- 3/16 inch Drill bit (for wood stud wall)
- Masonry drill bit (for concrete wall)
- Concrete screw anchors (for concrete wall)

Package Contents

Verify that you have received all of the parts listed below:

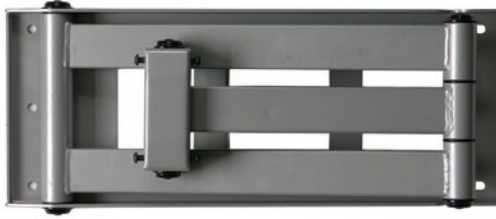

Articulating Arm/Wall Mounting Plate



Screen Plate



Wall Hardware

- 6 - 3" X 7/16" lag bolts
- 6 - 3/4" washers



Screen Hardware

- Hex wrench
- 6 - 3/8" x 1/2" black spacer
- 6 - 3/8" x 3/4" black spacer
- 6 - 3/4" washers
- 6 - 7/16" washers
- 6 - M6 x 30mm screws
- 6 - M6 x 15mm screws
- 6 - M5 x 30mm screws
- 6 - M5 x 15mm screws
- 6 - M4 x 30mm screws
- 6 - M4 x 12mm screws

If any parts are missing or damaged, contact K2Mounts at support@k2mounts.com for a replacement. K2Mounts is not liable for damage or injury caused by incorrect mounting, incorrect assembly, or incorrect usage.

Installation

To mount to a wood stud wall, continue below. To mount to a concrete wall, go to page 4.

Wood Stud Wall Installation

Locate the Wall Studs

Wall studs run vertically (up and down) inside the wall, behind the drywall or plaster. You must attach the mounting plate to two separate wall studs that run from floor to ceiling. This mount requires that the wall studs be 16 inches apart (on center).

1. Using the stud finder, mark the left and right edges of the studs closest to where you want to mount the screen.
2. Mark the centerline of each stud.

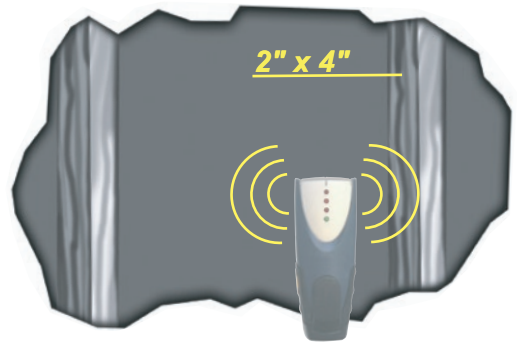

Drill Mounting Holes

1. *If you have the installation poster:*

- a. Tape the poster to the wall with the ACTUAL SIZE TEMPLATE side showing. Line up the mounting holes with the centers of the wall studs. Level the Articulating Arm/Wall Mounting Plate.

- b. Drill where indicated with a 3/16" drill bit, 2 1/2" deep.

If you do not have the installation poster:

- a. Hold the Articulating Arm/Wall Mounting Plate up to the wall, lining up the left-most and right-most mounting holes and with the centers of the wall studs. Level the Articulating Arm/Wall Mounting Plate.

- b. Make marks on the wall through all the left-most and right-most holes and then remove the Articulating Arm/Wall Mounting Plate from the wall.

- c. Drill five holes at the marks with a 3/16" drill bit, 2 1/2" deep.

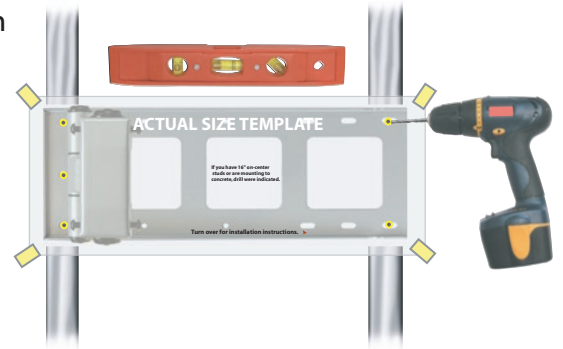

Anchor Articulating Arm/Wall Mounting Plate to the Wall

1. Using the ratchet and 7/16 inch socket, anchor the Articulating Arm/Wall Mounting Plate to the wall with five of the 7/16" x 2" Lag Bolts and Washers from the Wall Hardware bag.

2. Go to "Attach the Screen Plate to the Screen" section on page 5.

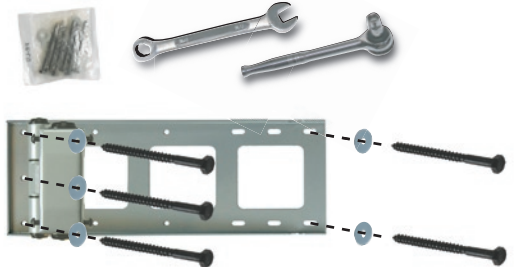

Concrete or Concrete Block Wall Installation



Warning: Attaching the wall mount to a brick wall could result in property damage or personal injury.

Obtain Concrete Anchors

The hardware needed to mount to a concrete wall is not included.

Purchase at least 5 concrete anchors with a weight rating that will accommodate your screen plus the weight of the mounting bracket (about 16 lbs.).

Install Anchors

1. *If you have the installation poster:*

- a. Tape the poster to the wall with the ACTUAL SIZE TEMPLATE side showing.

- b. Install the anchors where indicated on the poster.

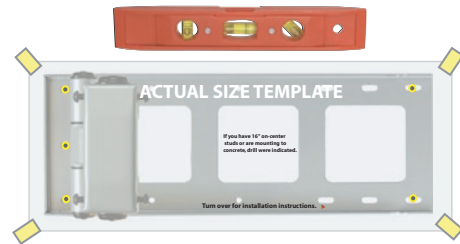

If you do not have the installation poster:

- a. Hold the Articulating Arm/Wall Mounting Plate up to the wall where you want to mount the bracket.

- b. Make marks on the wall through all the left-most and right-most holes. Remove the Articulating Arm/Wall Mounting Plate from the wall.

- c. Install anchors at the marks you made in the previous step.

Anchor Wall Mounting Plate to Wall

1. Anchor the Articulating Arm/Wall Mounting Plate to the wall with at least five Lag Bolts and Washers. If you use the bolts and washers from the Wall Hardware bag, make sure that they are suitable for the anchors used.

2. Go to “Attach the Screen Plate to the Screen” section on the next page.

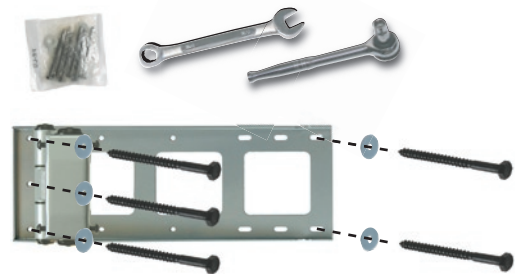

Attach the Screen Plate to the Screen

1. Line up the holes in the Screen Plate with the holes on the back of the screen.
2. If the screws that came with your screen hold the plate securely, use them, otherwise use screws from those provided in the Screen Hardware bag.
3. Attach the Screen Plate with a washer and then a screw in each hole.

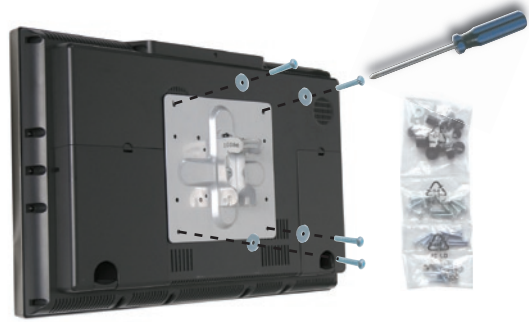

Attach the Screen Plate to the Arm

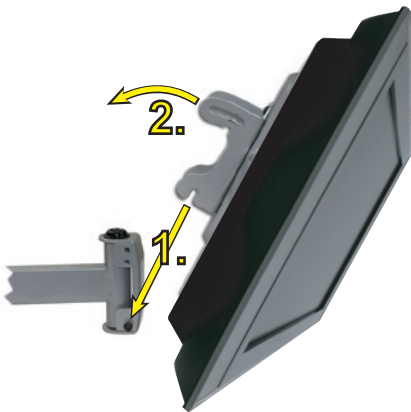

1. Using the hex wrench provided in the Screen Hardware bag, remove the upper hex screws protruding from the arm. Then hook the bottom of the Screen Plate on the bottom hex screws protruding out of the sides of the arm.
2. Slowly rotate the screen so that the top slot lines up with the screw hole at the desired viewing angle.

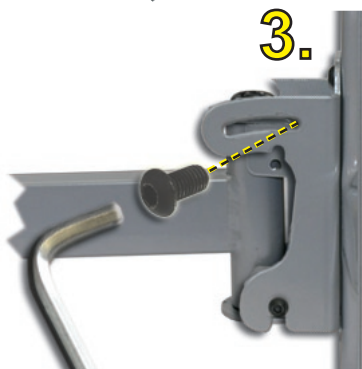

3. Install a hex screw in the left side of the Screen Plate.

4. Install the second hex screw in the right side of the Screen Plate.

5. If the screen needs to be rotated, adjust the rotation using the hex screw on the back of the screen plate between the upper two hex screws.



6. Tighten all the hex screws.



Specifications



Caution: *This mounting bracket is intended for use only with the maximum load weight indicated. Use with products heavier than the maximum weight indicated may result in instability and possibly cause injury.*

| | |
|-----------------------------|---|
| Bracket Weight: | 15.4 lbs |
| Tilt Range: | 5 degrees up, 14 degrees down |
| Maximum Load Weight: | 110 lbs |
| VESA Monitor sizes: | 75 x 75, 100 x 100, 200 x 200 |
| Monitor Sizes: | All sizes VESA 75, 100 and 200, not exceeding maximum weight limit. |

K2Mounts Warranty

K2Mounts warrants to the original purchaser of its mounting brackets for the life of the bracket, that the bracket shall be free from defects in assembly, material, or workmanship and will repair or replace, at its sole discretion, a defective bracket free of charge, provided the bracket is returned to K2Mounts prepaid by purchaser. Unauthorized service or repairs by anyone other than K2Mounts or a pre-approved repair facility renders this warranty void and shall release K2Mounts from any further responsibility or obligation.

K2Mounts will repair or replace up to a maximum of \$10,000.00, at its option, any component (television, projector, monitor or screen) which is damaged by a K2Mounts bracket's failure to perform* when that product is properly installed** for its intended use. This Lifetime Warranty is subject to the limitations and exclusions set forth herein. K2Mounts will repair or replace the damaged components (television, monitor or screen) at K2Mounts option, up to an amount equal to the fair market value of the damaged equipment or the original purchase price of the equipment, whichever is less, up to the maximum amount set forth above.

K2Mounts reserves the right to inspect the damaged component, the Rhino Mount bracket alleged to have failed, and the site where the damage occurred. All costs of shipping the Rhino Mount bracket and damaged component to K2Mounts for inspection shall be borne solely by the purchaser. K2Mounts reserves the right to negotiate the costs of repairs. If K2Mounts determines, in its sole discretion, that it is impractical to ship the damaged component or bracket to K2Mounts, K2Mounts may designate, in its sole discretion, a component (television, monitor or screen) repair facility to inspect and estimate the cost to repair. The cost, if any, of shipping the component to and from such repair facility and of such estimate shall be borne solely by the purchaser. Damaged components must remain available for inspection until the claim is finalized. Whenever claims are settled, K2Mounts reserves the right to be subrogated under any existing insurance policies the claimant may have.

All above warranties are null and void if: the K2Mounts bracket in use during the occurrence is not provided to K2Mounts for inspection upon K2Mounts' request at the sole expense of the purchaser; or if K2Mounts determines that the K2Mounts bracket has been improperly installed, altered in any way or tampered with; or if it is determined by K2Mounts that the damage did not result from the K2Mounts product's failure or that in fact no occurrence took place; or the repair or replacement of the damaged equipment is covered under a manufacturer's warranty; or K2Mounts determines that the equipment was not used under normal operating conditions or in accordance with any labels or instructions. Improper installation voids the warranty. The K2Mounts warranty and insurance only protects against damage to properly connected and installed equipment where K2Mounts has determined, in its sole discretion, that the damage resulted from a K2Mounts product failure, and does not protect against acts of God such as flood, earthquake, war, vandalism, theft, normal-use wear and tear, corrosion or abuse. Any damage caused by failure to observe instructions for installation, or product limitations specified in the product manual or product specification -sheet, or mounting on unsuitable surfaces will not be covered by the K2Mounts warranty.

The warranty described herein shall be IN LIEU OF any other warranty, express or implied, including but not limited to, any warranty of MERCHANTABILITY or FITNESS FOR A PARTICULAR PURPOSE.

In no event shall K2Mounts be liable for incidental, special, direct, indirect consequential or multiple damages such as, but not limited to, lost business or profits arising out of the sale or use of any K2Mounts products, even if advised of the possibility of damages. This warranty and insurance gives you specific legal rights, and

you may also have other rights, which may vary from state to state. Some states do not allow the exclusion of limitation of incidental or consequential damage so the above limitations may not apply to you.

The warranty and insurance is valid only for the original purchaser of the product and only if the original purchaser registers the purchase on-line at www.k2mounts.com or by mailing a copy of the purchase receipt and product warranty registration card to screen Mounting Brackets Inc., 5 Hutton Centre Drive, Suite 830, Santa Ana, CA 92707 within thirty (30) days of the date of purchase. All damage claims against the product must be made within fifteen (15) days from the date of the occurrence and must be accompanied by a receipt for the damaged bracket or the warranty is void. Warranty is only valid in USA and Canada. To file a warranty claim please write to us at screen Mounting Brackets Inc., 5 Hutton Centre Drive, Suite 830, Santa Ana, CA 92707, within 15 days of the occurrence. Please provide to us or have the following information available:

- a. K2Mounts bracket part number.
- b. The equipment that was used with the K2Mounts bracket at the time of the occurrence.
- c. The component that was damaged during the occurrence and the extent of the damage.
- d. The date of the occurrence.
- e. Where you purchased the K2Mounts product.
- f. Date you purchased the K2Mounts product.
- g. Copy of the original receipt for the damaged product.

* Failure to perform in accordance with that bracket's specifications sheet or product manual

** Properly installed in accordance with that bracket's installation instruction sheet or bracket manual and only when mounted on approved surfaces.

K2 Mounts is a Product of TV Mounting Brackets, Inc.

© 2006 K2Mounts. All rights reserved.



Copyright 2006 K2Mounts.
All rights reserved.

k2mounts.com