

Gestetner® **RICOH** **SAVIN**®



G410/G411
IMAGE SCANNER
OPERATOR'S MANUAL

Safety Information

When using your machine, the following safety precautions should be always be followed

Safety During Operation

In this manual, the following important symbols are used:

 **WARNING:**

Ignoring this warning could cause serious injury or even death.

 **CAUTION:**

Ignoring this caution could cause injury or damage to property.

Examples of Indications



Symbol  means a situation that requires you take care.



Do NOT carry out the operation represented by this symbol .
This example means “Do not take apart”.



Symbols  mean you MUST perform this operation.
This example means “You must remove the wall plug”.

Warnings



- **Only connect the machine to the power source described on the inside front cover of this manual.**
- **Avoid multi-wiring.**
- **Do not damage, break or make any modifications to the power cord. Do not place heavy objects on it, pull it hard or bend it more than necessary. These actions could cause an electric shock or fire.**
- **Do not plug or unplug the power cord with your hands wet. Otherwise, an electric shock might occur.**



- **Make sure the wall outlet is near the machine and easily accessible so that in event of an emergency it can be unplugged easily.**



- **Do not remove any covers or screws other than those specified in this manual. Some parts of the machine are at a high voltage and could give you an electric shock. When the machine needs to be checked, adjusted, or repaired, contact your service representatives.**
- **Do not take apart or attempt any modifications to this machine. There is a risk of fire, electric shock, explosion or loss of sight.**



- **If the machine looks damaged or breaks down, smoke is coming out, there is a strange smell or anything looks unusual, immediately turn off the power switch then unplug the power cord from the wall. Do not continue using the machine in this condition. Contact your service representative.**
- **If metal, liquid, or foreign matter falls into the machine, turn off the power switch, and unplug the power cord. Contact your service representative. Do not keep using the machine with a fault or defect.**



- **Do not put any metal objects or containers holding water(e.g. vases, flowerpots, glasses) on the machine. If the contents fall inside the machine, a fire or electric shock could occur.**

 **CAUTION**



- *Keep the machine away from humidity and dust. A fire or an electric shock might occur.*
- *Do not place the machine on an unstable or tilted surface. If it topples over, it could cause injury.*



- *When you move the machine, unplug the power cord from the wall outlet to avoid fire or electric shock.*
- *When the machine will not be used for a long time, unplug the power cord.*



- *When you pull out the plug from the socket, grip the plug to avoid damaging the cord and causing fire or electric shock.*



- *This machine has been tested for safety using this supplier's parts and consumables. We recommend you only use these specified supplies.*

Important Information

1. Read all of these instructions and keep them for later reference.
2. Follow all warnings and instructions marked on the machine.
3. Unplug this machine from the wall outlet before cleaning. Do not use liquid cleaners or aerosol cleaners.
4. Do not use this machine near water.
5. Do not place this machine on an unstable cart, stand, or table. The machine could fall and suffer serious damage.
6. Slots and openings in the cabinet and the back or bottom are provided for ventilation; to ensure reliable operation of the machine and protect it from overheating, these openings must not be blocked or covered. The openings should never be blocked by placing the machine on a bed, sofa, rug, or other similar surface. This machine should never be placed near or over a radiator or heat register. This machine should not be placed in a built-in installation unless proper ventilation is provided.
7. This machine should be operated from the type of power source indicated on the marking label. If you are not sure of type of power available, contact your dealer or local power company.
8. This machine is equipped with a 3-wire grounding-type plug, a plug having a third (grounding) pin. This plug will only fit into a grounding -type outlet. This is a safety feature. If you are unable to insert the plug into the outlet, contact your electrician to replace your outlet. Do not defeat the purpose of the grounding-type plug by removing its grounding pin. (This does not apply in countries in which a 2-wire, nongrounded type of plug is used.)
9. Do not place this machine where the cord will be walked on.
10. If an extension cord is used with this machine, make sure that the total of the ampere ratings on the devices plugged into the extension cord does not exceed the extension cord ampere rating. Also make sure that the total of all machines plugged into the wall outlet does not exceed 15 amperes.
11. Never push objects of any kind into this device through cabinet slots as they may touch dangerous voltage points or short out parts that could result in a risk of fire or electric shock. Never spill liquid of any kind on the machine.
12. Except as specifically explained in the operator's manual, do not attempt to service this device yourself. Opening or removing those covers that are marked "Do Not Remove" may expose you to dangerous, voltage points or to other risks. Refer all servicing in those compartment to service personnel.

13. Unplug this machine from the wall outlet and refer servicing to qualified service personal under the following conditions;
 - A. When the power cord or plug is damaged or frayed.
 - B. If liquid has been spilled into the machine.
 - C. If the machine has been exposed to rain or water.
 - D. If the machine does not operate normally when the operating instructions are followed. Adjust only those controls that are covered by the operating instructions since improper adjustment of other controls may result in damage and will often required extensive work by a qualified technician to restore the machine to normal operation.
 - E. If the machine has been dropped or the cabinet has been damaged.
 - F. If the machine exhibits a distinct change in performance, indicating a need for service.
14. Make sure that your wall outlet is close to the machine and is easily accessible. When you plug the machine into the outlet, make sure the plug is inserted firmly.
15. The main plug on this machine must be used to disconnect main power. Two kinds of size notation are employed in this manual.

How to Read This Manual

In this manual, the following symbols are used:

 **Warning**

This symbol indicates a potentially hazardous situation that might result in death or serious injury when you misuse the machine without following the instructions under this symbol. Be sure to read the instructions, all of which are described in the Safety Information section.

 **Caution**

This symbol indicates a potentially hazardous situation that might result in minor or moderate injury or property damage that does not involve personal injury when you misuse the machine without following the instructions under this symbol. Be sure to read the instructions, all of which are described in the Safety Information section.

* The statements above are notes for your safety.

 **Important**

If this instruction is not followed, paper might be misfeed, originals might be damaged, or data might be lost. Be sure to read this.

 **Note**

This symbol indicates precautions for operation, or actions to take after misoperation.

 **Limitation**

This symbol indicates numerical limits, functions that cannot be used together, or conditions in which a particular function cannot be used.

 **Reference**

This symbol indicates a reference.

[]

Keys built into the machine's operation panel.

Table of Contents

Safety Information	i
Safety During Operation	i
Examples of Indications	i
Important Information	iv
How to Read This Manual	vi

1. Introduction

Features	1
Ultra-fast scanning	1
Simultaneous scanning of both sides of a document	
(Duplex Model only)	1
Direct operation using the buttons on the scanner	
(Manual Scanning function)	1
Large 150-sheet paper capacity	1
Printing on scanned documents (optional)	1
Space-saving design	2
Supports both TWAIN and ISIS	2
Guide to the Scanner	3
Understanding the Indicators	5

2. Setting up the Scanner

Preparing for Installation	7
Checking the Scanner Location	7
Connecting to the Host Computer	10
What is SCSI?	10
SCSI Connection Requirements for the Scanner	10
Setting the SCSI ID	11
Connecting the SCSI Cable (No Connection to Other Port)	11
Connecting the SCSI Cable (Connection to Other Port)	12
Connecting the Power Cable	13
Turning On/Off the Scanner Power	15
Turning On the Scanner Power	15
Turning Off the Scanner Power	15
Initializing the Scanner	16

Table of Contents

3. Setting Originals

Originals ----- **17**
 Recommended Sizes and Weights of Originals ----- 17
 Difficult to Detect Sizes ----- 18
 Original Sizes and Scanning Area ----- 19
Setting Originals ----- **20**
 Setting the Original on the Contact Glass ----- 20
 Setting the Original in the Auto Document Feeder (ADF) ----- 21

4. Scanning Originals

General Scanning Method ----- **25**
Manual Scanning ----- **26**

5. Troubleshooting

When Scanning Does Not Start ----- **27**
Error Indicators and Solutions ----- **28**
Procedures to Correct Errors in the ADF ----- **29**
 When an Original is Jammed in
 the Auto Document Feeder (ADF) ----- 29
 When an Original was Not Output Properly from
 the Auto Document Feeder (ADF) ----- 29
 When There is a Problem with the Operation of
 the Document Table ----- 29
**When Characters Printed by the Endorser are Too Light or
the Original Gets Dirty** ----- **30**
 Replacing the Ink Ribbon ----- 30
 Cleaning the Endorser ----- 32

6. Appendices







Maintenance	33
Cleaning the Scanner	33
Cleaning the Contact Glass, Slit Glass, White Sheet, and Platen	34
Cleaning the Feed Roller and Drum	34
Cleaning the White Roller (Duplex Model Only)	36
Moving the Scanner	38
Carrying the Scanner a Short Distance	39
Shipping the Scanner	39
Disposing of the Scanner	39
Options	40
Image Processing Unit Type A	40
Red Lamp Unit Type A	40
Endorser Unit Type A(Printing Function)	41
Specifications	42
Scanner Electrical and Hardware Specifications	42
DIP Switches	43
Functions	44
Preview	44
Scan	45
Scanning Composition	45
Binary Scanning/Threshold	46
Halftone Scanning	47
Gray Scale Scanning	48
Area Extraction	49
Section Area (Multi-area Settings)	50
Auto Photo/Letter	51
Resolution	52
Brightness	53
Contrast	53
Gamma Correction	54
Binary Filters	55
Parameter Download	55
Document Size Detection	56
Erase Background	57
Index	58

1. Introduction

Features

This section describes the features of this scanner.

Ultra-fast scanning

When scanning A4  (8½" × 11" ) , monochrome at 200dpi, this scanner can scan 55 (57) pages/minute. When scanning A4  (8½" × 11" ) , monochrome at 400dpi, this scanner can scan 31 (32) pages/minute. During double-sided scanning, when scanning A4  (8½" × 11" ) , monochrome at 200dpi, this scanner can scan 81 (84) pages/minute.

- * When using the Auto Document Feeder (ADF) in binary scanning, these speeds apply to the second and subsequent sheets.

Simultaneous scanning of both sides of a document (Duplex Model only)

If a document consists of individual, separate sheets, both sides of each sheet can be scanned simultaneously. This capability eliminates the bother of having to flip document sheets over.

Direct operation using the buttons on the scanner (Manual Scanning function)

If using a driver that supports the Manual Scanning function, scanning can be initiated by pressing the **[Start]** button on the scanner. This function is useful when scanning a document that needs to be set in place for each scan.

Large 150-sheet paper capacity

Up to 150 sheets* can be placed in the scanner's Auto Document Feeder (ADF).

- * A4 (64g/m²) or 8½" × 11" (20lb)

Printing on scanned documents (optional)

The Endorser Unit Type A is provided as an optional mechanism that prints a symbol or the number of documents that have been scanned by the Auto Document Feeder (ADF). This capability is useful for referencing scanned data or confirming that a document has been scanned.

1. Introduction

Space-saving design

This scanner is designed in a “wingless” style, in which there are no protruding elements, such as a document tray. This design allows the scanner to be set up next to a wall, and permits office space to be used more effectively.

Supports both TWAIN and ISIS

The scanner supports both the standard TWAIN and the newer ISIS driver, allowing the scanner to function with a wide range of software.

Guide to the Scanner

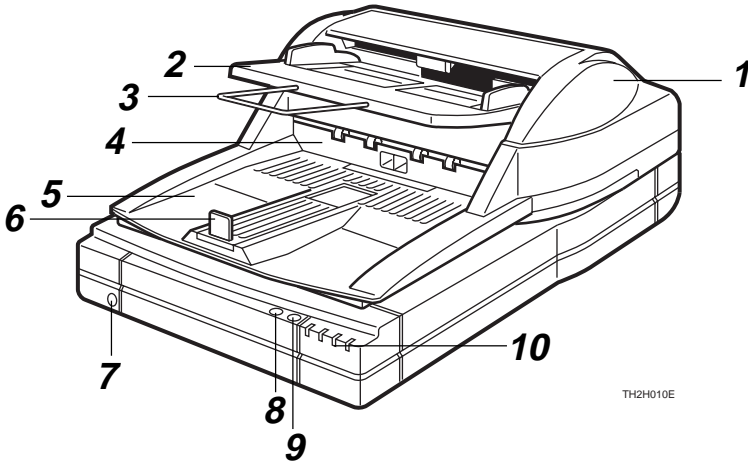

TH2H010E

1. Auto Document Feeder (ADF)

This is used to automatically feed and scan documents.

2. Document Table

Documents that are to be scanned by the Auto Document Feeder (ADF) are placed here.

3. Auxiliary Table

This table can be extended outwards when placing large documents in the Auto Document Feeder (ADF).

4. Endorser Cover

Open this cover in order to clean the Endorser (printing function) or replace the ink.

5. Output Table

After a document has been scanned by the Auto Document Feeder (ADF), it is output here.

6. Stopper

This stops documents that have been scanned and output by the Auto Document Feeder (ADF).

7. Power Switch

This switch is used to turn the scanner power on and off.

8. [Clear Modes] Button

This button is used to stop manual scanning.

9. [Start] Button

This button is used to start manual scanning.

10. Scanner Indicators

These indicators can be used to check the status of the scanner.

1. Introduction

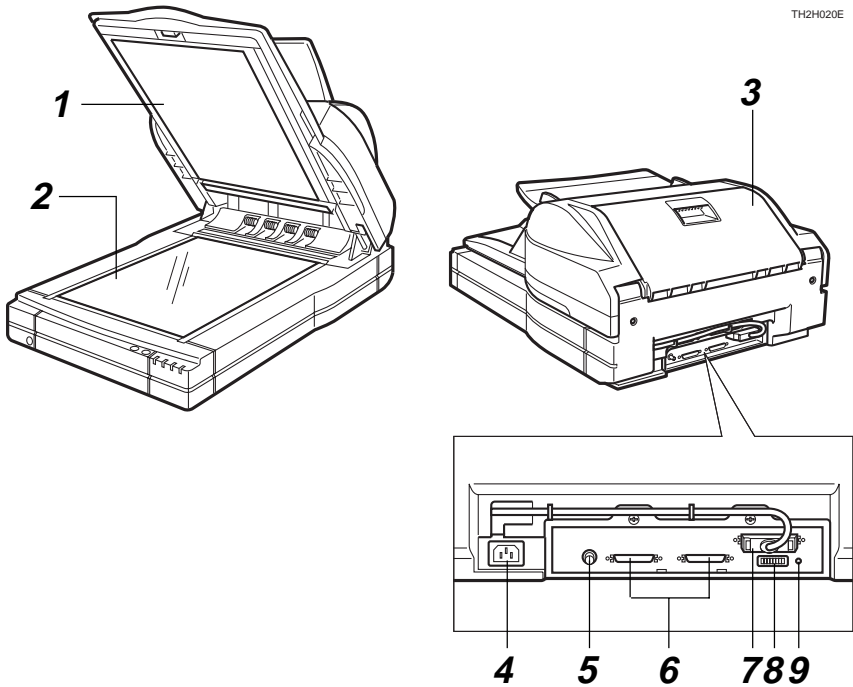

1. White Sheet

This presses the document down on the contact glass.

2. Contact Glass

This is where the document is placed.

3. ADF Cover

Open this cover to clear paper jams, etc.

4. Power Connector

Connect the power cable here.

5. Rotary Switch

This switch is used to set the SCSI ID.

6. SCSI Connector

Connect the SCSI interface cable here.

7. Interface for Reverse Side Scanning

This is an extension interface for reverse side scanning. (Duplex Model only)

8. DIP Switches

These switches are used to set the operating mode.

9. Reset Switch

This switch resets the scanner as if the power had been turned off and then back on again. This switch is used to make new DIP switch and rotary switch settings valid.

Understanding the Indicators

The scanner has the following indicators:

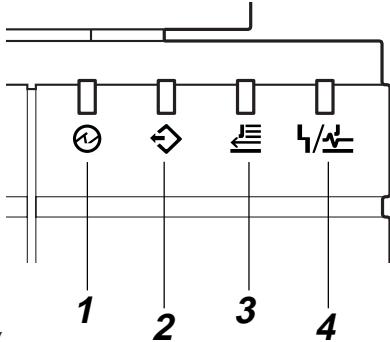

- 1: Power On
- 2: Machine Busy
- 3: Document in Place
- 4: Error

When the scanner is in a normal operating state, the indicators will light in one of the combinations shown below. If the indicators light in any other pattern, an error has occurred. Refer to p. 28, “Error Indicators and Solutions.”

				Description
○	○	○	○	When the power has just been turned on, or the Reset switch has been pressed (This combination is displayed only for a few seconds.)
○	●	●	●	When there is no document in the Auto Document Feeder, and no document is being scanned
○	●	○	●	When there is a document in the Auto Document Feeder, but the document is not being scanned
○	○	●	●	When scanned data is being transferred (and there is no document in the ADF)
○	○	○	●	When scanned data is being transferred (and there is a document in the ADF)
○	●	X	●	When the scanner is ready for manual scanning
X	●	●	●	When the scanner is ready by Low Power Mode

- : On
- X : Flashing
- : Off

1. Introduction

2. Setting up the Scanner

This chapter explains the preparations that are necessary in order to use the scanner.

Preparing for Installation

Checking the Scanner Location

Set up the scanner in a location that satisfies the following conditions:

◆ **Setup location**

⚠ **Warning:**



- *Make sure the wall outlet is near the machine and easily accessible so that in event of an emergency it can be unplugged easily.*

Caution



- *Keep the machine away from humidity and dust. A fire or an electric shock might occur.*
- *Do not place the machine on an unstable or tilted surface. If it topples over, it could cause injury.*

Set up the scanner on a flat, stable surface.

- The surface must be level to within 5mm (0.2") on all sides.

2. Setting up the Scanner

◆ Installation space

Set up the scanner in a location where there is enough space to provide the clearance shown in the figure below.

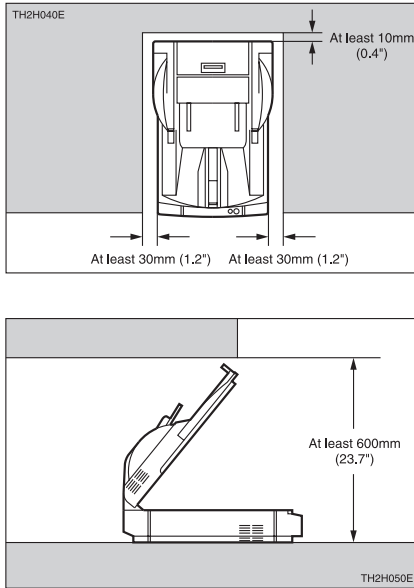

◆ Installation environment

⚠ Important

- ❑ Do not set up the scanner in any of the types of locations listed below. Doing so could cause the scanner to malfunction.
 - In a location exposed to direct sunlight
 - In a location where the scanner will be subjected to blowing air or radiant heat, such as near an air conditioner or heater
 - In a location near other electronic devices, such as a radio or television set
 - In a location subject to extreme temperatures or humidity
 - Near a humidifier

Preparing for Installation

Set up the scanner in a location where the temperature and humidity will fall within the ranges shown below.

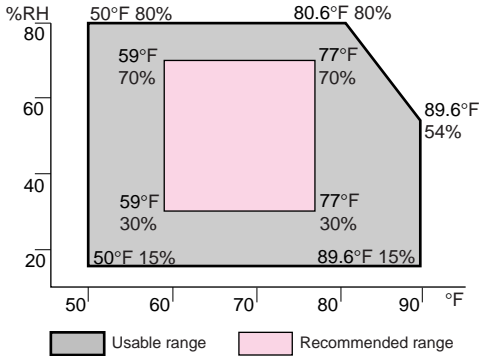
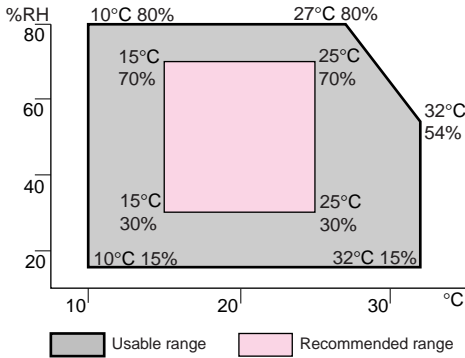

Important

- Save the box and cushioning material in which the scanner was packed so that they can be used if it is necessary to transport the scanner in the future.

Connecting to the Host Computer

This scanner connects to a host personal computer through a SCSI interface. This section provides an overview of SCSI, and explains how to connect the scanner to a host computer.

What is SCSI?

“SCSI” (Small Computer System Interface) is an interface standard that is used for high-speed data transfer between a peripheral device and a host computer.

- In a SCSI connection, ANSI-compliant SCSI cables are used to connect one or more peripheral devices in daisy chain fashion to the host computer.
- Each device is assigned a unique SCSI ID (0 to 7), which must be set for the device before turning on the power and before turning on the computer.
- The last device in the daisy chain requires a terminator.

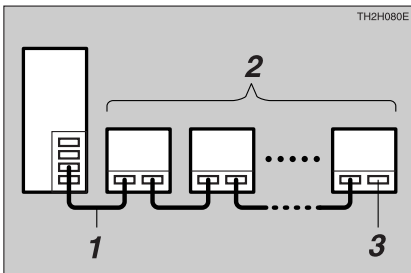

- 1: SCSI cables
- 2: Up to 7 devices
- 3: Terminator

Important

- If two or more devices in a daisy chain share the same SCSI ID, misoperation and data loss may result. Set a unique SCSI ID for this scanner that does not duplicate the SCSI ID of any other device.

SCSI Connection Requirements for the Scanner

- This scanner complies with the SCSI-2 standard. SCSI-1-compliant peripheral devices can also be connected and used with this scanner. The SCSI interface on the scanner has a 50-pin half-pitch (pin type) connector. Connect an ANSI-compliant shielded SCSI-2 cable to the scanner. Note that some combinations of cables and SCSI boards will not work together properly, so check this carefully.
- If you are using a SCSI board and driver software that supports SCAM, the SCSI ID of this scanner will be set automatically, so there is no need to set the ID. If you are using a driver that does not have a SCAM function, it will be necessary to set the SCSI ID for the scanner if the SCSI ID is identical to that of another device that is connected.
- The scanner's terminator can be enabled or disabled by turning a DIP switch on or off.

Important

- ❑ The total length of the SCSI cables, including the length of the cable inside the personal computer, should be no more than 3m (9.8 ft.) when using synchronous transfer, and no more than 6m (19.7 ft.) when using asynchronous transfer.
- ❑ Some combinations of SCSI boards and peripheral devices that are connected simultaneously may not work together properly.

Setting the SCSI ID

- 1** Turn the rotary switch to set the SCSI ID number.

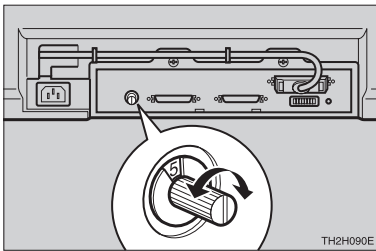

Note

- ❑ If you change the setting while the power is on, it is necessary to initialize the scanner. Refer to P.16, “Initializing the Scanner.”

Connecting the SCSI Cable (No Connection to Other Port)

- 1** Turn off the host computer and all peripheral devices that will be connected through the SCSI interface.
- 2** Use SCSI cables to connect the personal computer and the peripheral devices in daisy chain fashion, with this scanner at the end of the daisy chain. (Use either of the two SCSI connectors on the scanner.)
- 3** Set DIP switch 3 to off.

This enables the scanner’s internal terminator. For details on the functions of the DIP switches, refer to P.43, “DIP Switches.”

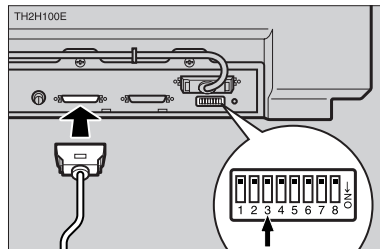

Connecting the SCSI Cable (Connection to Other Port)

- 1** Turn off the host computer and all peripheral devices that will be connected through the SCSI interface.
- 2** Use SCSI cables to connect the personal computer and the peripheral devices in daisy chain fashion, with this scanner in the middle of the daisy chain.
- 3** Set DIP switch 3 to on.
This disables the scanner's internal terminator. For details on the functions of the DIP switches, refer to P.43, "DIP Switches."

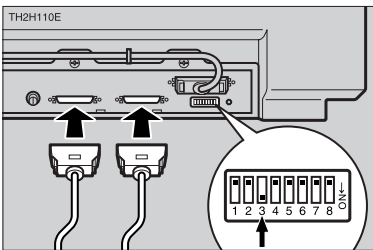

Connecting the Power Cable

This section explains how to connect the power cable to the scanner.

Warning



- **Only connect the machine to the power source described on the inside front cover of this manual.**
- **Avoid multi-wiring.**
- **Do not damage, break or make any modifications to the power cord. Do not place heavy objects on it, pull it hard or bend it more than necessary. These actions could cause an electric shock or fire.**
- **Do not plug or unplug the power cord with your hands wet. Otherwise, an electric shock might occur.**

Warning



- **Be sure to ground the scanner. Failure to ground the scanner could result in fire or electric shock. If there is no ground connection available, consult your dealer.**

Caution

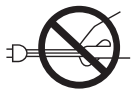

- **When you pull out the plug from the socket, grip the plug to avoid damaging the cord and causing fire or electric shock.**

1 Confirm that the power switch is off.

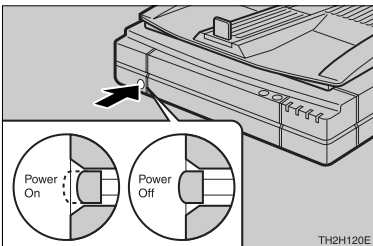

2. Setting up the Scanner

- 2** Push the power cable plug all of the way into the power connector on the scanner.

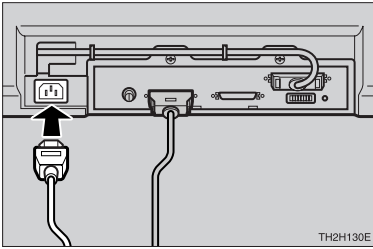

Note

- Use the power cable that was provided with this scanner.

- 3** Plug the other end of the power cable into the power outlet.

Turning On/Off the Scanner Power

Turning On the Scanner Power

When turning on the power, turn on each device in the daisy chain one by one, starting from the device that is at the opposite end of the daisy chain away from the host computer and working towards the host computer. Turn on the host computer last.

- 1** Press the power switch so that it is in the “Power On” position as shown below.

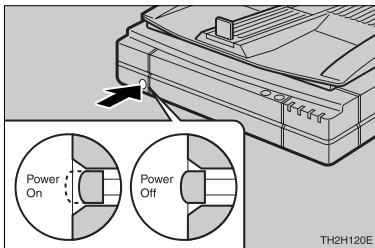

Turning Off the Scanner Power

- 1** Press the power switch so that it is in the “Power Off” position as above.

2. Setting up the Scanner

Initializing the Scanner

If the SCSI ID rotary switch or DIP switch settings have been changed while the power is on, it is necessary to initialize the scanner in order to put the new settings into effect. To initialize the scanner, either turn the power off and then back on again, or else perform the procedure described below:

- 1** Using an object with a thin tip, such as a ballpoint pen, press the reset switch located on the back of the scanner.

Doing so puts the scanner into the same state as if the power had been turned off and then back on again.

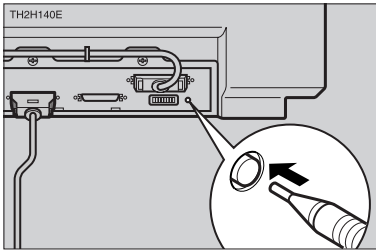



3. Setting Originals

This section explains how to set originals that are to be scanned in the scanner.

Originals can be set either on the contact glass or in the Auto Document Feeder (ADF). The Auto Document Feeder (ADF) is useful when you want to scan multiple originals consecutively.

Originals

Recommended Sizes and Weights of Originals

Where original is set	Original size	Original weight
Contact glass	Up to A3 Up to 11" x 17"	---
Auto Document Feeder (ADF)	Maximum:A3  Minimum:69 x 120mm	41 ~ 128g/m ²
	Maximum:11" x 17"  Minimum:2.75" x 4.75"	11 ~ 34lb

❖ Originals that cannot be set in the Auto Document Feeder (ADF)

Setting an original that falls in one of the following categories in the Auto Document Feeder (ADF) could result in a paper jam or in damage to the original. Such originals should be placed on the contact glass.

- An original that does not fall within the “Recommended Sizes and Weights of Originals”
- An original that includes staples, paper clips, glue, or other adhesives
- An original that has holes or is torn
- An original that is warped, creased, or wrinkled
- An original that is pasted together
- An original that has some sort of surface treatment, including thermal paper, art board, silver paper, carbon paper, or conductive paper.
- An original that has index tabs, stick-on notes, or other protrusions
- An original on paper that does not slide easily, such as tracing paper
- An original on thin, fragile paper
- An original that is not of a suitable thickness, such as a postcard
⇒ “Recommended Sizes and Weights of Originals”
- An original that is bound, such as a book





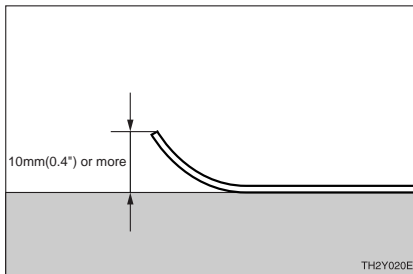
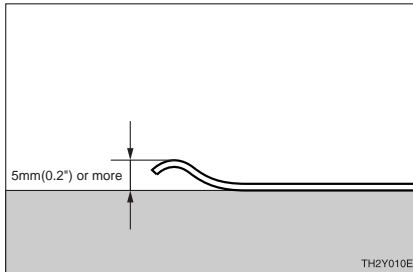





3. Setting Originals

- An original that is highly transparent, such as transparencies or tracing paper
- An original that has markedly curled edges, such as shown below



Difficult to Detect Sizes

When the optional Image Processing Unit Type A is installed, the scanner can automatically detect the size of an original. However, the sizes of the following types of originals are difficult to detect properly, even if using a scanner driver that supports automatic detection of the size of the original:

- An original that has index tabs, stick-on notes, or other protrusions
- An original that is highly transparent, such as transparencies or tracing paper
- Documents on a dark background
- Documents with text, illustrations, or filled in portions on the leading edge
- An original that is not A3 , B4 , A4 , B5 , A5 , B6 , A6 , DLT , LT , or HLT  (when set on the contact glass)

Original sizes that can be detected automatically

Original size Where original is placed	Paper sizes used in Japan										Paper sizes used overseas						Irregular sizes
	A3 ☐	B4 ☐	A4 ☐	A4 ☐	B5 ☐	A5 ☐	A5 ☐	B6 ☐	B6 ☐	A6 ☐	11" x 17" (DTL) ☐	8½" x 14" (LG) ☐	8½" x 11" (LT) ☐	8½" x 5½" (LT) ☐	8½" x 5½" (HLT) ☐	8½" x 5½" (HLT) ☐	
Contact glass	✓	✓	✓		✓	✓			✓		✓			✓			
Auto Document Feeder (ADF)	✓	✓	✓	✓	✓	✓	✓	✓	✓		✓	✓	✓	✓	✓	✓	✓

Original Sizes and Scanning Area

◆ **Contact glass**

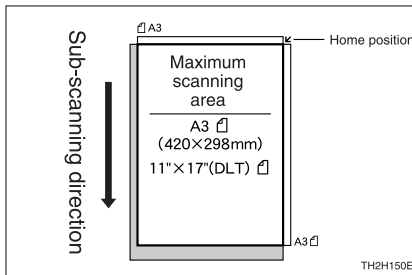

◆ **Auto Document Feeder (ADF)**

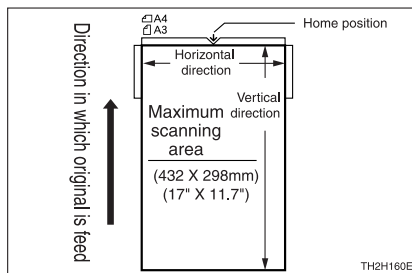

Setting Originals

Setting the Original on the Contact Glass

 **Caution**



- *Be careful not to pinch your fingers when closing the Auto Document Feeder (ADF).*

1 Open the Auto Document Feeder (ADF).

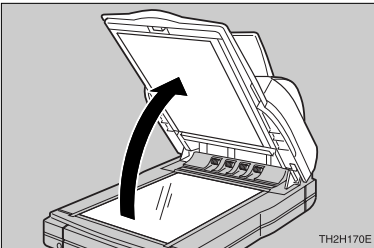

2 With the side to be scanned facing down, place the original on the contact glass, and align it with the home position and scale.

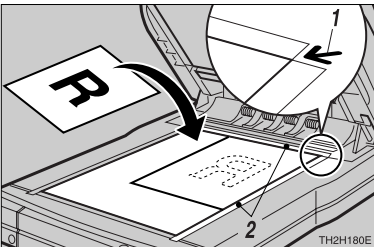

- 1: Home position
- 2: Scale

 **Important**

- Do not press down on the contact glass. Strong localized pressure on the contact glass could cause it to break.

3 Gently close the Auto Document Feeder (ADF).

Setting the Original in the Auto Document Feeder (ADF)

Note

- Do not set originals in the Auto Document Feeder (ADF) in excess of the upper limit mark. (Stacked height: Not more than 15mm (0.6"))
- The number of sheets that can be set in the Auto Document Feeder (ADF) at one time depends on the size and weight (thickness) of the originals. Use the following table as a guide:

Stacked height	Weight	Size	Number of sheets that can be set
15mm (0.6")	105g/m ² (24lb)	A4, A5, (LT, HLT)	110
		A3 (DLT)	80
	64g/m ² (20lb)	A4, A5, A3 (LT, HLT, DLT)	150

Limitation

- When the original has a dark background, the scanner may not be able to recognize that a document has been placed in the ADF. If this happens, place the document on the contact glass instead.

1 Align the originals on the ADF.

- When scanning large originals, pull out the auxiliary table.
- Adjust the stopper on the output table according to the size of the originals.

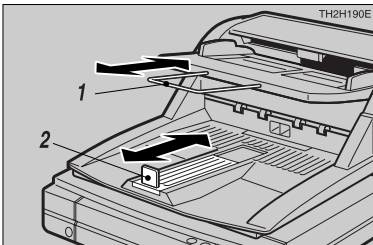

- 1: Auxiliary table
- 2: Stopper

3. Setting Originals

Note

- When scanning an original that is A5 (HLT) size or smaller, pull the stopper out of the output table, turn it around, slide it back into the table, and adjust the position. (Refer to the diagram below.)

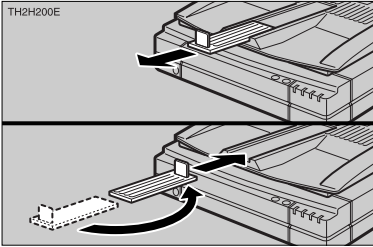

Important

- When the stopper is extended, do not grasp the stopper when opening or closing the Auto Document Feeder (ADF).
- 2** Put the originals in order. If they are to be scanned in page sequence, put them in order as illustrated below.

Simplex scanning

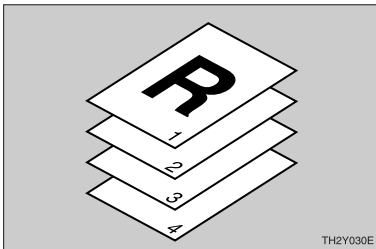

Duplex scanning

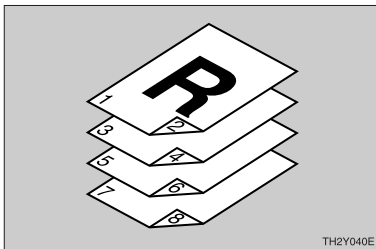

- 3** Fan the sheets, and then line up their edges.

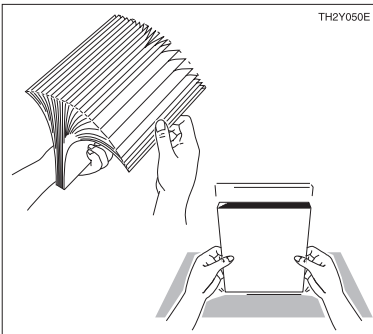

- 4** With the first page facing up on top, place the originals in the Auto Document Feeder (ADF), and adjust the positions of the guides so that they touch the edges of the original.

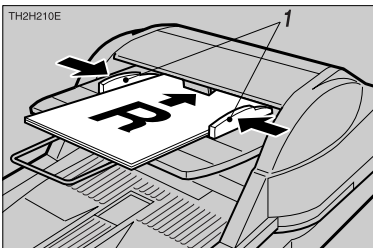

1: Guides

3. Setting Originals

4. Scanning Originals

General Scanning Method

Scanning of an original is initiated by software that is TWAIN or ISIS compatible. The method of operation depends on the software. For details, refer to the manual that was supplied with your software.

Limitation

- When using double-sided scanning, if the leading edge of the reverse side of the document is dark, the scanned image may appear whitish.

Manual Scanning

By setting up a scanner driver that supports the manual scanning function, scanning can be initiated by pressing the **[Start]** button.

If the manual scanning function is used, then communications between the scanner and the personal computer are no longer needed in cases where it is necessary to set the original in the scanner one sheet at a time, for example.

- 1** Set the manual scanning function through the scanner driver.
- 2** Set the original in the scanner.
- 3** Press the **[Start]** button. To end manual scanning, press the **[Clear Modes]** button.

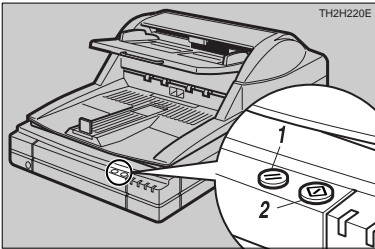

- 1: **[Clear Modes]** Button
2: **[Start]** Button

5. Troubleshooting

When Scanning Does not Start





If scanning does not start, check the following:

Item to check	Action
Is the power on?	Turn on the power.
Is the SCSI ID set properly?	If there are any other SCSI devices connected, the host computer may not be able to recognize the scanner if it has the same SCSI ID as another device. Refer to P.11, "Setting the SCSI ID," and set a unique SCSI ID for the scanner.
Are the DIP switches set properly?	The correct DIP switch settings depend on whether this scanner is the last device in the SCSI daisy chain. Refer to P.11, "Connecting the SCSI Cable," and set the DIP switches properly.
Are the SCSI cables connected securely?	If any cables are disconnected, connect them.
Are the indicators on or flashing?	The nature of an error can be determined according to the pattern in which the four indicators are on or flashing. Refer to P.28, "Error Indicators and Solutions."
Is the scanner driver selected properly?	For details on scanner driver setup, refer to the manual or help information for your scanner driver.
Are the software settings correct?	For details on software settings, refer to the manual or help information for your software.

5. Troubleshooting

Error Indicators and Solutions

When the indicators are on or flashing in any of the following combinations, an error has occurred. After confirming the nature of the error, take the appropriate action.

				Description of error	Action
○	●	●	○	The Auto Document Feeder (ADF) or the ADF cover is not closed properly.	Close the Auto Document Feeder (ADF) or the ADF cover.
○	●	×	○	An original is jammed in the Auto Document Feeder (ADF).	Refer to P.29, “Procedures to Correct Errors in the ADF,” and remove the jammed paper.
○	●	○	○	An original was not output properly from the Auto Document Feeder (ADF).	Refer to P.29, “Procedures to Correct Errors in the ADF,” and remove the paper that was not output.
○	●	×	×	There is a problem with the operation of the document table.	Refer to P.29, “Procedures to Correct Errors in the ADF” and open and close the ADF cover.
×	×	○	●	The Endorser (printing function) may have malfunctioned.	Try opening and closing the Auto Document Feeder (ADF) several times. If the same error occurs, contact a service center.
×	×	×	×	System error	Contact a service center.

○ : On

×

● : Off

Procedures to Correct Errors in the ADF

When an Original is Jammed in the Auto Document Feeder (ADF)

- 1 Open the ADF cover.
- 2 Turn the drum knob in the direction indicated by the arrow.

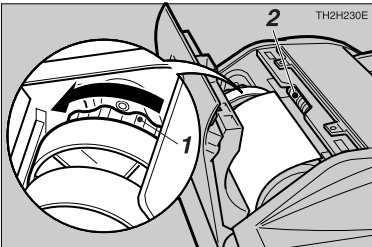

- 1: Knob
2: Feed roller

- 3 Remove the original from the output table.

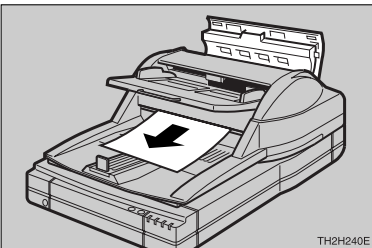

Note

- If the leading edge of a original is jammed in the feed rollers, grasp the leading edge of the original and gently pull it out in the direction of the ADF cover.

When an Original was Not Output Properly from the Auto Document Feeder (ADF)

- 1 Open the ADF cover.
- 2 Pull out the original.

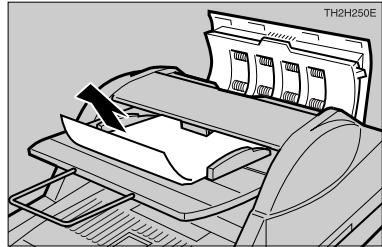

When There is a Problem with the Operation of the Document Table

- 1 Remove the original from the Auto Document Feeder (ADF).
- 2 Open the ADF cover.

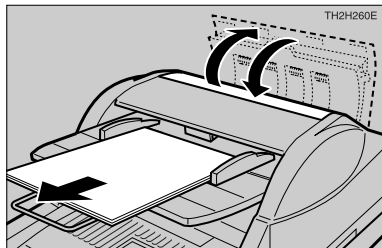

- 3 Close the ADF cover.

When Characters Printed by the Endorser are Too Light or the Original Gets Dirty

Replacing the Ink Ribbon

⚠ Caution

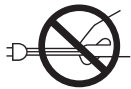

- When you pull out the plug from the socket, grip the plug to avoid damaging the cord and causing fire or electric shock.

Replace the ink ribbon if the Endorser's printing becomes too light.

- 1** Turn off scanner power, and unplug the power cable from the power outlet.
- 2** Flip open the Endorser cover (located towards the rear of the output table), and pull the cover out.

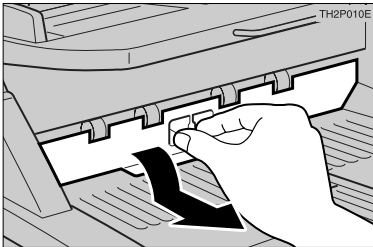

- 3** Grasp the green portion of the Endorser, and turn it in the direction indicated by the arrow until it clicks.

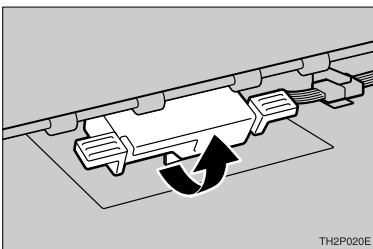

When Characters Printed by the Endorser are Too Light or the Original Gets Dirty

- 4** Raise the rear portion of the Endorser, and then pull the Endorser out.

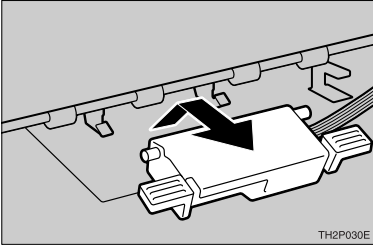

! Important

- Do not pull on the Endorser's cord.

- 5** Place the Endorser down with the printing section facing up.

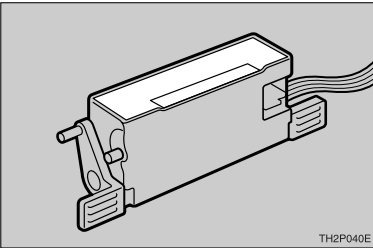

! Important

- Do not touch the printing section of the Endorser. Doing so may get your fingers dirty, and could damage the printing section.

- 6** Gently press the old ink ribbon cartridge down ①, and then pull it out ②.

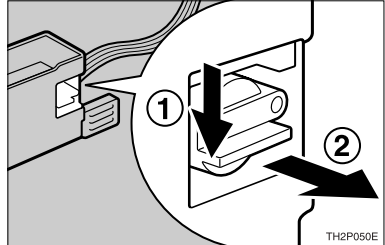

- 7** Push a new ink ribbon cartridge into the Endorser.

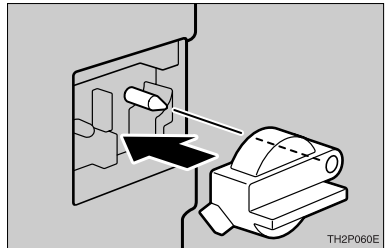

- 8** Align the endorser with the hooks on the scanner as shown in the diagram.

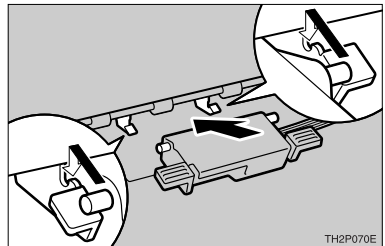

5. Troubleshooting

- 9** Push the Endorser in until it clicks, and tuck the Endorser's power cord into the appropriate hook.

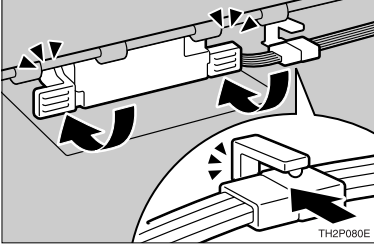

- 10** Slide the protrusion on the bottom of the cover into the output table, and then push the cover closed.

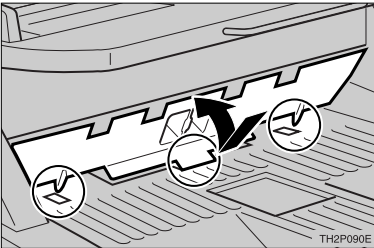

Cleaning the Endorser

If paper scraps and dust accumulate in the vicinity of the printing section of the Endorser, printing quality will be adversely affected. If the printing section becomes dirty, gently wipe the portion shown in white in the illustration below with a dry, soft cloth.

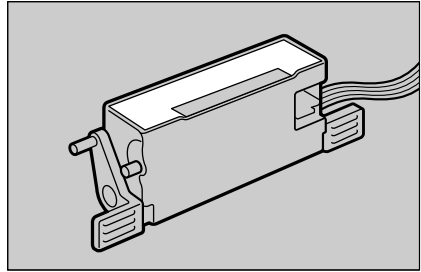

Important

- Do not wipe any portion other than that which is shown in white above. In addition, do not touch the printing section. Doing so may get your fingers dirty, and could damage the printing section.

6. Appendices

Maintenance

Cleaning the Scanner

 **Warning**

- *Do not remove any covers or screws other than those specified in this manual. Some parts of the machine are at a high voltage and could give you an electric shock. When the machine needs to be checked, adjusted, or repaired, contact your service representatives.*
- *Do not take apart or attempt any modifications to this machine. There is a risk of fire, electric shock, explosion or loss of sight.*

 **Caution**

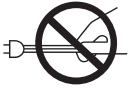

- *When you pull out the plug from the socket, grip the plug to avoid damaging the cord and causing fire or electric shock.*

Periodic cleaning is required in order to maintain this scanner in good condition.

First, wipe away any dirt with a dry, soft cloth. If the dirt cannot be removed with a dry cloth, moisten a soft cloth with water, wring it out thoroughly, and then wipe away the dirt. If water is not sufficient to remove the dirt, wipe off the dirt with a mild detergent solution, then wipe the detergent away with water, and then wipe the area with a dry cloth until all moisture has been removed.

 **Important**

- Do not use volatile chemicals such as benzene or paint thinner to clean the scanner, and do not spray insect sprays, etc., on the scanner. Such chemicals could deform, discolor, or crack scanner components.
- If there is any dust or dirt inside the scanner, wipe it away with a dry, clean cloth.

6. Appendices

Cleaning the Contact Glass, Slit Glass, White Sheet, and Platen

Caution



- *Be careful not to pinch your fingers when closing the Auto Document Feeder (ADF).*

- 1** Turn off scanner power, and unplug the power cable from the power outlet.
- 2** Wipe these components with a soft, dry cloth.

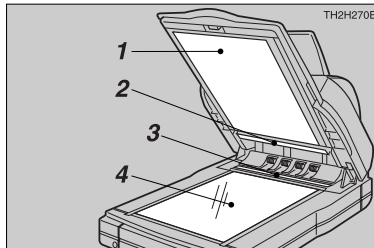

- 1: White Sheet
- 2: Platen
- 3: Slit Glass
- 4: Contact Glass

Cleaning the Feed Roller and Drum

- 1** Turn off scanner power, and unplug the power cable from the power outlet.
- 2** Open the ADF cover, and then while turning the feed roller and drum by hand, wipe them with a damp cloth that has been thoroughly wrung out.
To turn the drum, turn the blue knob.

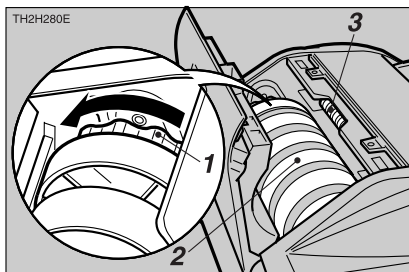

- 1: Feed Roller
- 2: Drum
- 3: Knob

 **Note**

- Always clean the feed roller after scanning an original that was written in pencil or with some other material that is not solidly fixed on the paper.
If you do not clean the feed roller, it may dirty the next original that is scanned.

6. Appendices

Cleaning the White Roller (Duplex Model Only)

If white stripes (in the normal paper direction) appear in the image from the reverse side of the original when a double-sided document is scanned, clean the white roller according to the procedure described below.

- 1** Turn off scanner power, and unplug the power cable from the power outlet.
- 2** Open the Auto Document Feeder (ADF), and pull off the white sheet (which is held in place by cellophane tape).

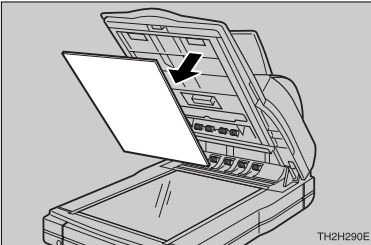

- 3** While turning the blue knob on the drum in the direction indicated by the arrow, wipe the white roller with a damp cloth that has been thoroughly wrung out.

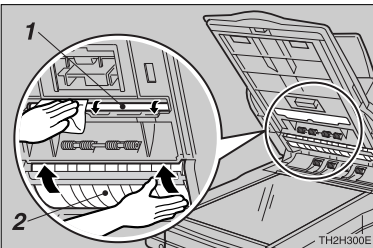

- 1: White roller
- 2: Drum

- 4** Place the white sheet on the contact glass with the reverse side facing up.

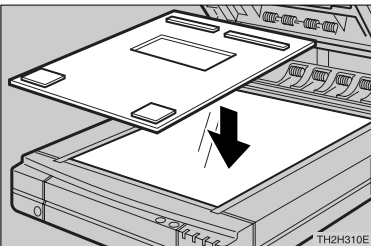

- 5** Align the arrow on the reverse side of the white sheet with the document home position.

Note

- Make sure that the white sheet does not lie on the scales.

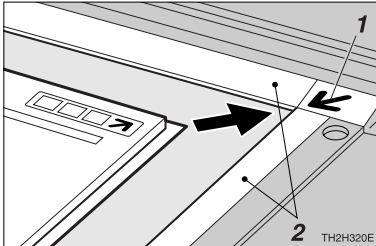

- 1: Home position
2: Scales

- 6** Gently close the Auto Document Feeder (ADF), and press it down on it firmly.

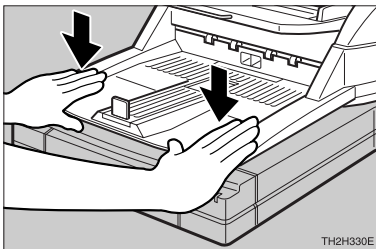

- 7** Open the Auto Document Feeder (ADF) again, and rub a cloth against the entire surface of the white sheet.



Moving the Scanner

 **Caution**



- *The scanner weighs a maximum 29kg. When moving the scanner, always hold it with the Auto Document Feeder (ADF) against yourself, and lift it up slowly so as not to strain yourself. Trying to lift the scanner even though it is too heavy for you, or handling the scanner carelessly and dropping it can result in injury.*
- *When it is necessary to move the scanner a long distance, contact a service center.*

 **Caution**



- *When you move the machine, unplug the power cord from the wall outlet to avoid fire or electric shock.*
- *When the machine will not be used for a long time, unplug the power cord.*

 **Caution**

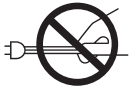

- *When you pull out the plug from the socket, grip the plug to avoid damaging the cord and causing fire or electric shock.*

- The minimum time for which will be kept inventories of replacement parts needed for maintenance services is seven years from the date that a model goes out of production. Accordingly, after this period has elapsed, it may not be possible to accept a unit for repairs.
- If you contact a service center, they will prepare the scanner for safe shipment for you. However, you will be responsible for the actual packing and shipping of the scanner.

Carrying the Scanner a Short Distance

- 1** Turn off scanner power, and unplug the power cable from the power outlet.
- 2** Disconnect the SCSI cables.
- 3** Grasping the scanner on the sides, above the bottom, and with the Auto Document Feeder (ADF) closest to yourself, carry the scanner to its new location.

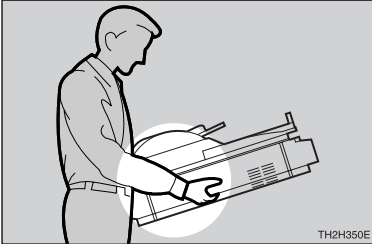

Important

- When carrying the scanner, try to keep it as level as possible.

Shipping the Scanner

When shipping the scanner, pack it in its original shipping carton.

Important

- Disconnect all cables.
- Because the scanner is a precision instrument, pack it carefully so that it will not be damaged while in transit.

Disposing of the Scanner

When you wish to dispose of your scanner, contact your dealer or a service center.

Options

This section describes options that are sold separately.

Image Processing Unit Type A

Note

- The Image Processing Unit Type A is an option.

If this option is used, the following image processing features become possible:

Dynamic Threshold

This function automatically determines a suitable threshold value on the basis of the brightness of the original, and converts the scanned image to binary data.

Limitation

- During double-sided scanning, this function is valid only for the front side of the original.

Auto Photo/Letter

This function automatically identifies the text portions of an original and the photographic portions, and scans each in a suitable scan mode.

Limitation

- During double-sided scanning, this function is valid only for the front side of the original.

Document Size Detection

This function automatically detects the width of an original, and sends the information to the host computer.

Section Area

This function selects an area within an original and sets scanning conditions for that area.

Limitation

- During double-sided scanning, this function is valid only for the front side of the original.

For details on installing the Image Processing Unit Type A, refer to the supplement, “Setting up the Image Processing Unit Type A.”

Red Lamp Unit Type A

Note

- The Red Lamp Unit Type A is an option. The Red Lamp Unit Type A can be used to eliminate red elements, such as marker or red pen. To install or replace the Red Lamp Unit Type A, contact your dealer or a service center.

Endorser Unit Type A (Printing Function)

 **Note**

- The Endorser Unit Type A (Printing Function) is an option for some models, and is standard equipment on other models.

The Endorser Unit Type A (printing function) can print a symbol or number on originals that have been scanned by the Auto Document Feeder (ADF). The Endorser Unit Type A (printing function) settings are made through the scanner driver. For details on how to set the Endorser Unit Type A, refer to the manual and help provided for the scanner driver that you will be using.

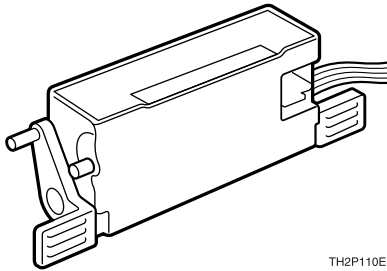

TH2P110E

Specifications

Scanner Electrical and Hardware Specifications

Type	Desktop flatbed scanner
Scanning methods	Fixed original scanning and moving original scanning
Scanning area	Main-direction: 298mm (11.7") max. Sub-direction: 432mm (17") max.
Resolution	Main-scanning: 400dpi Sub-scanning: 400dpi
Gray scale	8 bits/pixel
Scanning time	0.65 seconds (A4 □ /200dpi/binary) 0.62 seconds (LT □ /200dpi/binary)
Scanning speed	Simplex Model: 55ppm (A4 □ /200dpi/binary) 57ppm (LT □ /200dpi/binary) Duplex Model: 81ppm (A4 □ /200dpi/binary) 84ppm (LT □ /200dpi/binary) *ppm: pages per minute
Warm-up time	Max. 15 seconds
Interface	SCSI-2 50-pin half-pitch (pin type) x 2
Power consumption	Simplex Model: 50W maximum when in standby (options installed) 90W maximum when operating (options installed) Duplex Model: 80W maximum when in standby (options installed) 120W maximum when operating (options installed)
Size	470mm (W) x 677mm (D) x 278mm (H) 18.5" (W) x 26.7" (D) x 10.9" (H)
Weight	Simplex Model: Approximately 25kg (55.1lb) Duplex Model: Approximately 29kg (63.9lb) (Add 2kg (4.4lb) when the Endorser Unit Type A is installed.)

DIP Switches

Only the settings of DIP switches 1 through 3 can be changed. Do not change the settings of the other switches.

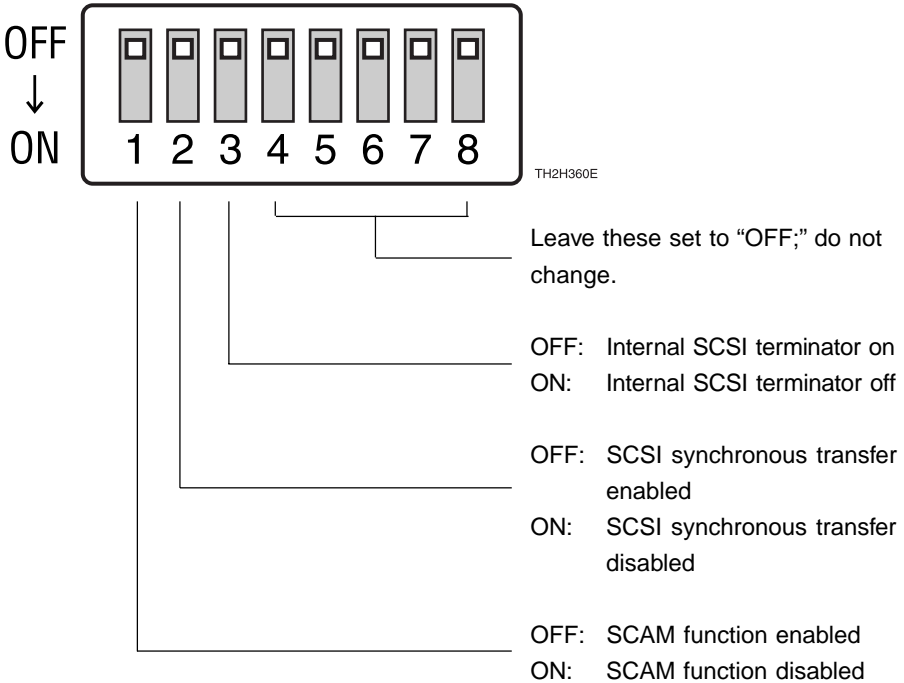

Important

- ❑ If multiple devices that support the SCAM function are connected on the same daisy chain, the host will not be able to recognize the IDs. In this case, set DIP switch 1 to “ON” (SCAM function disabled), and set the SCSI ID with the rotary switch.
- ❑ If the daisy chain is too long, or if a nonstandard SCSI cable is used, misoperation may occur during synchronous transfer. In this case, set DIP switch 2 to “ON” (SCSI synchronous transfer disabled).
- ❑ If this scanner is connected in the middle of a daisy chain, set DIP switch 3 to “ON” (internal SCSI terminator off).

Functions

The scanner driver can be used to perform the following image processing functions:

Preview	(P.44)
Scan	(P.45)
Scanning Composition	(P.45)
Binary Scanning/Threshold	(P.46)
Halftone Scanning	(P.47)
Gray Scale Scanning	(P.48)
Area Extraction	(P.49)
Section Area (Multi-area Settings)	(P.50)
Auto Photo/Letter	(P.51)
Resolution	(P.52)
Brightness	(P.53)
Contrast	(P.53)
Gamma Correction	(P.54)
Binary Filters	(P.55)
Parameter Download	(P.55)
Document Size Detection	(P.56)
Erase Background	(P.57)

Note

- The scanner operates according to the scanner driver settings, but some scanner drivers do not support all of the scanner functions. In such a case, the unsupported functions are not available for use.

In addition, the names used in this manual for certain functions may differ from the names used by the scanner driver. For details, refer to the scanner driver manual.

Preview

This function scans the entire scanning area at low resolution (100dpi*). The preview image can then be viewed while setting the scanning area for the final scan. The preview function can also be used to get a quick view of the scannable area.

- * “dpi” is an abbreviation for “dots per inch,” and indicates resolution. A larger value indicates greater detail.

Scan

This function scans an original once the scanning area, scanning composition, resolution, and other values have been set.

When setting these values, consideration should be given to the original that is to be scanned and to the output device (display, printer, etc.). For example, it is meaningless to scan an original at high resolution if the resolution of the output device is lower than the scanning resolution, especially because high-resolution scanning uses a great deal of memory and requires more processing time.

Scanning Composition

There are three scanning composition modes: binary scanning, halftone scanning, and multi-value scanning.

◆ **Binary scanning**

This mode scans the original in black and white. This mode is used to scan originals that consist only of text, line drawings, and other elements that lack intermediate colors.

◆ **Halftone scanning**

This mode scans the original in pseudo-halftones created by dots. This mode is used to output an original that contains intermediate colors, such as a photo, on an output device that can only express binary per pixel, such as a laser printer.

◆ **Gray Scale scanning**

This mode scans the original with 16 or 256 gradations. This mode is used to output an original that contains intermediate colors on an output device that can express different gradations for a single pixel, such as a Dye Sublimation printer or a display.



Original



Binary



Halftone



Gray Scale

6. Appendices

Binary Scanning/Threshold

The binary scanning function converts the original into black and white image data. If the original contains any intermediate colors, they are compared with the threshold value and determined to be either black or white accordingly. The threshold value can be set to any of 255 gradations; any intermediate colors that are brighter than the threshold value are scanned as “white,” and those that are darker than the threshold value are scanned as “black.” This mode should be used to scan originals that have no intermediate colors and consist of only two colors, such as text or line drawings.

The threshold value should be set according to the intensity of the original. For example, setting a high threshold value when scanning faint text will produce text that is much clearer. Conversely, setting a low threshold value when scanning an original that is on a colored background (such as text on colored paper) will eliminate the background color from the scan.

There are two modes for the threshold value setting:

◆ Standard mode

Any one of 255 values can be set.

◆ Dynamic threshold mode

This function is valid only when the optional Image Processing Unit Type A is installed. With this mode, the optimal threshold value (given the brightness of the original) is set automatically.



Original

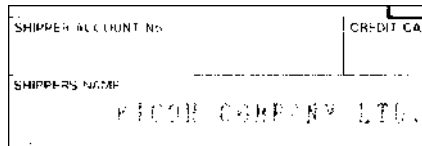

Low threshold value

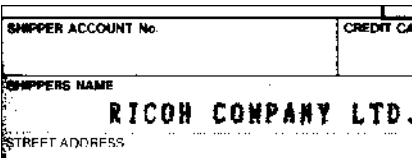

High threshold value

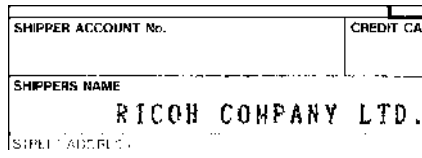

Dynamic threshold mode

Halftone Scanning

Halftone scanning converts the original into an image consisting of pseudo-halftones produced by dot shading (in which shading is achieved through combinations of black and white dots, as in newspaper photographs). This function is used to output an original that has intermediate tones, such as a photo, on an output device that can only produce monochrome output, such as a laser printer.

Because halftone scanning expresses pseudo-halftones, it does not require as much memory, making it effective for filing a large volume of images. There are eleven types of halftones (ten dot shading patterns and one error diffusion pattern) for selection. It is also possible to scan and download your own dot shading patterns.

The names in parentheses indicate the names under the ISIS driver.



Original

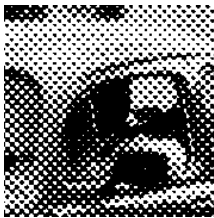

8 x 4 45°

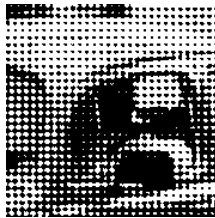

6 x 6 90°

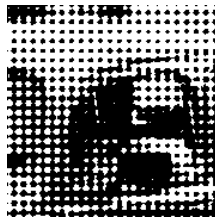

8 x 8 90°

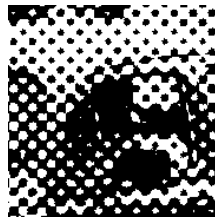

16 x 8 45°

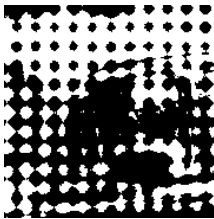

16 x 16 90°



4 x 4 Spiral

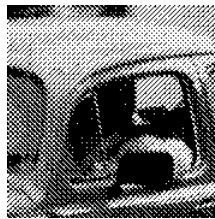

8 x 8 Bayer

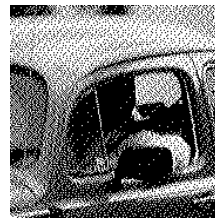

Error diffuson

6. Appendices

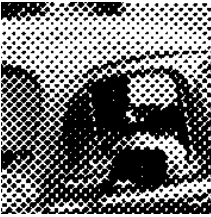

70 LPI

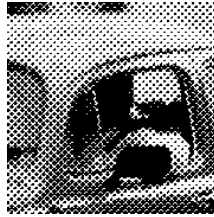

95 LPI

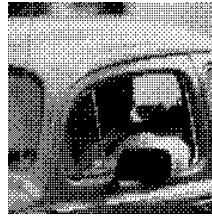

180 LPI

Gray Scale Scanning

Gray Scale scanning converts an original into image data consisting of 4-bit or 8-bit gradations. Four bits can express 16 gradations, and eight bits can express 256 gradations. This function is used to output an original that contains intermediate tones on an output device that can express intermediate tones for a single pixel, such as a display or a Dye Sublimation printer.

Although a higher number of bits produces higher image quality, it is important to remember that the processing time will be longer. For example, when an area is scanned using the 8-bit multi-scan mode, it requires eight times as much memory as when scanning the same area through binary scanning or halftone scanning.



Original



4-bit image

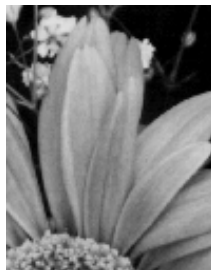

8-bit image

Area Extraction

This function extracts and scans a specified rectangular area within a scanning area. For example, to scan just the photograph portion of the original shown below, specify the area where the photograph is located. The rectangular area is specified by specifying the coordinates of the upper left corner of the rectangle, and the vertical and horizontal lengths.

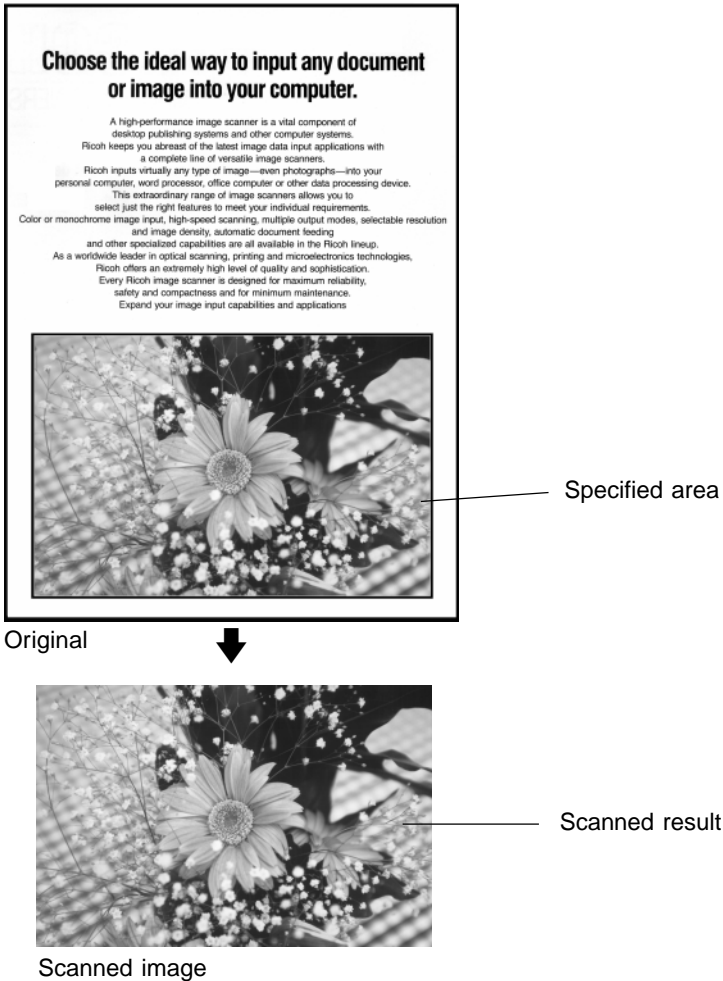

6. Appendices

Section Area (Multi-area Settings)

This function permits the specification of up to four rectangular areas of any size within the scanning area, each of which can be set as the scanning area. When overlapping areas are set, the area that was set last takes priority.

For example, when a single original contains both text and photos, specify rectangular areas for each, and then set binary scanning mode for the text areas and halftone scanning mode for the photographs. This function allows each area to be scanned in its respective scanning mode in one scan.

Limitation

- During double-sided scanning, this function is valid only for the front side of the original.

Note

- Note that scanning might not be performed in the specified manner if any of the four rectangular areas overlap. In this case, either decrease the number of rectangles, or else reduce them in size.
- This function is valid only when the optional Image Processing Unit Type A is installed.



1. Binary scanning is set for the whole page
2. Halftone scanning is set for this area
3. Halftone scanning is set for this area
4. Halftone scanning is set for this area

Original

When this function is not used

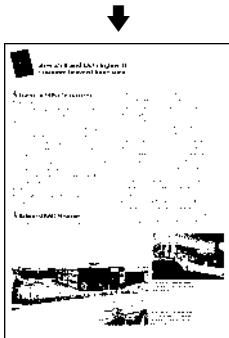

Result of settings described above

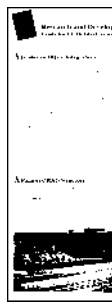

When entire original was scanned through binary scanning



When entire original was scanned through halftone scanning

Auto Photo/Letter

This function automatically determines whether the image being scanned is text (binary image) or photo (intermediate tone image), and scans the text areas in binary scanning mode and the photos in halftone scanning mode. This function is used in order to automatically scan text in binary scanning mode and photos in halftone scanning mode. This function allows you to scan an original that contains both text and photos just once while automatically scanning each type of area in the appropriate scanning mode without having to make special settings for each.

 **Note**

- This function is valid only when the optional Image Processing Unit Type A is installed.

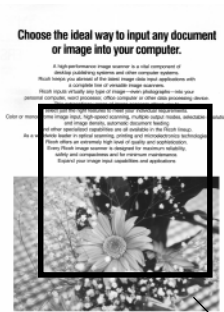

Original

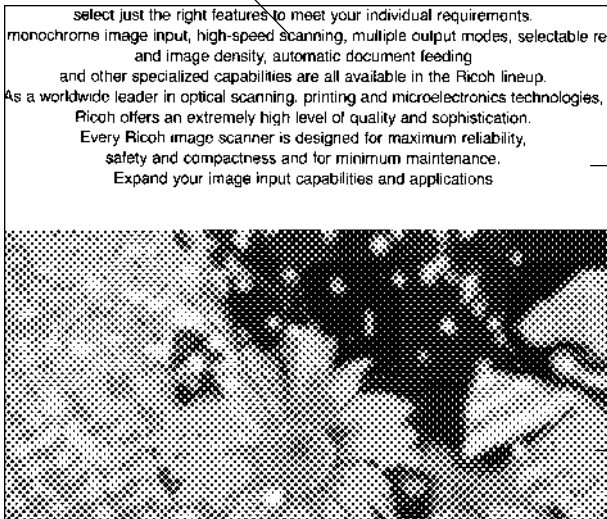

Scanned in binary scanning mode

Scanned in halftone scanning mode

Resolution

This function permits setting separate resolutions for the main-scanning and the sub-scanning, over a range of 100dpi to 800dpi (in 1dpi increments) for each. A high resolution setting requires more free space in memory and requires more processing time.

Basically, when outputting a scanned image that is the same size as the original image, set the same resolution as that of the output device. Image quality will suffer if the resolution is less than that of the output device, and it is meaningless to set a resolution that is higher than the resolution that the output device is capable of. However, if the output image is to be enlarged or reduced compared to the original, change the resolution by the same ratio.

📌 Limitation

- When this function is used during duplex scanning, the maximum image data size for the reverse side is 360 million bytes.

📝 Note

- When using this function, the image on the reverse side might be scanned through the document, depending on the condition of the original.



Original



Low resolution



High resolution

Brightness

The brightness can be adjusted to 255 levels. If a high value is set for the brightness, the image will become brighter overall. If a low value is set, the image will become darker overall.

When scanning a dark original, set a high value for the brightness; when scanning a bright original, set a low value for the brightness. For example, if a dark original is scanned normally, any gradations in the darker portions will be lost and will appear to be solid black in the scanned image. By increasing the brightness value in this case, the gradations in the darker portion will also appear in the scanned image. Conversely, if the bright portions of an original become solid white in the scanned image, lowering the brightness value will bring out the gradations in the bright portion in the scanned image.



Low brightness



High brightness

Contrast

The contrast can be adjusted to 255 levels. If a high contrast value is set, the resulting image will have high contrast and will be sharply defined. If a low contrast value is set, the resulting low-contrast image will have a softer feel.

To produce a sharp image, increase the contrast value, to produce a soft image, decrease the contrast value. For example, when scanning a photo of metal, glass, etc., set a high contrast value in order to achieve a sharp feel.



Low contrast

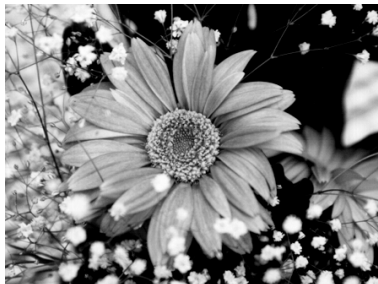

High contrast

Gamma Correction

The following types of gamma correction are possible. However, different models of output devices have different characteristics. Select a suitable gamma curve for the original that is to be scanned and the output device.

❖ **Normal**

Emphasizes the contrast slightly, resulting in a somewhat sharp scanned image.

❖ **Sharp**

Emphasizes the contrast, resulting in a sharp scanned image.

❖ **Soft**

Decreases the contrast, resulting in a soft scanned image.

❖ **Linear**

Outputs the image as scanned.

❖ **User-defined**

Downloads a user-defined gamma curve for gamma correction.



Normal



Sharp



Soft



Linear

Binary Filters

The following two filters can be used for binary scanning.

◆ **Noise removal**

This filter is used to eliminate the unnecessary small dots that appear when scanning an original that is the result of several generations of photocopying.



When filter is not used



When filter is used

◆ **Smoothing**

This filter is used to smooth out small bumps within an image.



When filter is not used



When filter is used

 **Note**

- This function is valid only when the optional Image Processing Unit Type A is installed.

Parameter Download

This function allows a user to download user-created gamma curves and halftone patterns to the scanner.

The details of how to download the data depends on the software being used.

Document Size Detection

This function automatically detects the width of the original, and sends the information to the personal computer.

Document Size Detection on the Contact Glass

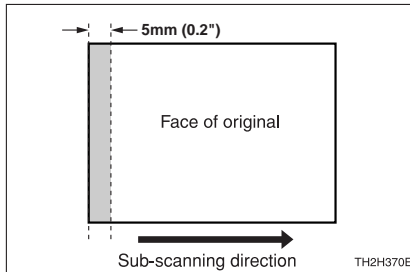

Document Size Detection in the Auto Document Feeder (ADF)

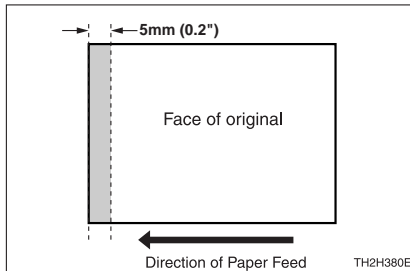

Note

- If there is any coloring on the leading edge (5mm, 0.2") of the original, the size of the original might not be detected properly.
- If the sheets of the original are not set in position properly, the size of the original might not be detected properly. Line up the edges of the sheets of the original, and position the guides on both sides so that they are touching the edges of the original and will ensure that the original feeds straight into the ADF.
- This function is valid only when the optional Image Processing Unit Type A is installed.

Erase Background

This function permits selection of the white side dynamic range for scanning.

When Erase Background is disabled

The dynamic range is set so that a white original (D value: 0.07) reaches maximum output.

When Erase Background is enabled

During scanning, the portion of the original that is closest to white is deemed to be white, and the dynamic range is set so that the portion in question reaches maximum output.

Index

A

ADF Cover ----- 4, 29, 34
Area Extraction ----- 49
Auto Document Feeder (ADF) --- 1, 3, 5,
17, 19, 21, 22, 23, 28, 29, 36, 37, 39
Auto Photo/Letter ----- 40, 51
Auxiliary Table ----- 3, 21

B

Binary Filters ----- 55
Binary Scanning ----- 45, 46
Brightness ----- 53

C

[Clear Modes] Button ----- 3, 26
Contact Glass ----- 4, 17, 19, 20, 34
Contrast ----- 53

D

Daisy Chain ----- 10, 43
DIP Switch ----- 4, 10, 27, 43
Document in Place ----- 5
Document Size Detection ----- 40, 56
Document Table ----- 3, 29
Drum ----- 34
Duplex Model ----- 1, 42
Dynamic Threshold ----- 40

E

Endorser ----- 1, 28, 30, 31, 32, 41, 42
Endorser Cover ----- 3, 30
Erase Background ----- 57
Error ----- 5

F

Feed roller ----- 29, 35

G

Gamma Correction ----- 54
Gray Scale Scanning ----- 45, 48

H

Halftone Scanning ----- 45, 47
Home Position ----- 20, 37

I

Image Processing ----- 40
Indicators ----- 5, 27, 28
Initializing the Scanner ----- 16
ink ribbon ----- 30
Interface for Reverse Side Scanning ----- 4
ISIS ----- 2, 25

K

Knob ----- 29, 34, 36

M

Machine Busy ----- 5
Manual Scanning ----- 1, 5, 26

O

Output Table ----- 3, 29, 30

P

Parameter Download	55
Platen	34
Power Cable.....	13
Power Connector	4, 14
Power On	5
Power Switch	3, 13, 15
Preview	44

R

Red Lamp Unit	40
Reset Switch	4, 16
Resolution	52
Rotary Switch.....	4, 11

S

Scale	20
SCAM	10, 43
Scanner Indicators	3
Scanning Composition	45
SCSI	10
SCSI Board	10
SCSI Cables	10, 11, 27, 39
SCSI Connector	4
SCSI ID	10, 11, 27
Section Area (Multi-area Settings)	50
Simplex Model	42
Slit Glass	34
【Start】Button	3, 26
Stopper	3, 21, 22

T

Terminator	10, 11, 43
Threshold	46
TWAIN	2, 25

W

White Roller	36
White Sheet	4, 34, 36

6. Appendices
