

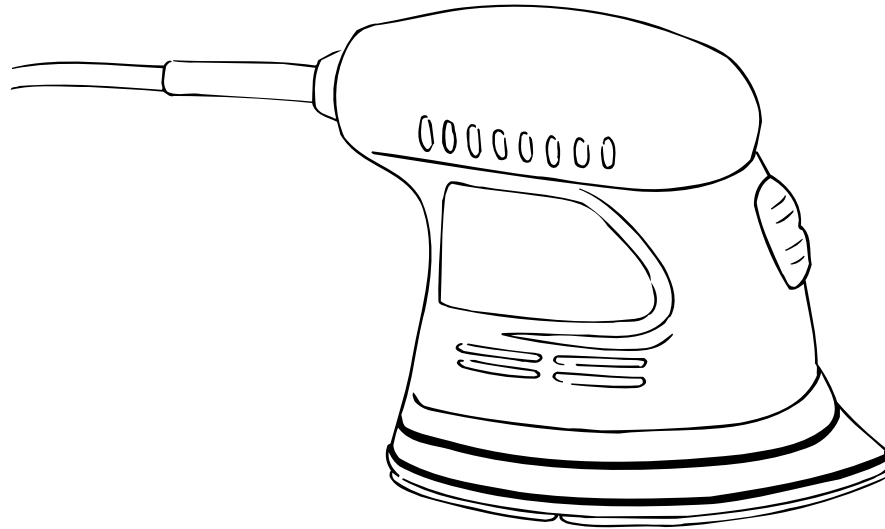

# OPERATOR'S MANUAL COMPACT FINISHING SANDER MODEL CFS1500 DOUBLE INSULATED



SPECIFICATIONS:	
Sanding Pad Length	5.5 in. (140 mm)
No Load Speed	12,000 opm
Rating	120 volts, 60 Hz, AC .80 Amperes
Net Weight	2.0 lbs. (0.9 kg)

## THANK YOU FOR BUYING A RYOBI SANDER.

Your new sander has been engineered and manufactured to Ryobi's high standard for dependability, ease of operation, and operator safety. Properly cared for, it will give you years of rugged, trouble-free performance.



**CAUTION: Carefully read through this entire operator's manual before using your new sander.**

Pay close attention to the Rules for Safe Operation, Warnings, and Cautions. If you use your sander properly and only for what it is intended, you will enjoy years of safe, reliable service.

Please fill out and return the Warranty Registration Card so that we can be of future service to you.

Thank you again for buying a Ryobi sander.

**SAVE THIS MANUAL FOR FUTURE REFERENCE**

# TABLE OF CONTENTS

■ Table of Contents and Introduction .....	2
■ Rules for Safe Operation .....	3-5
■ Symbols .....	5
■ Features.....	6-7
■ Unpacking .....	7
■ Operation .....	8-9
■ Maintenance.....	10
■ Notes .....	11
■ Parts Ordering / Service/Extension Cord Caution .....	12

## INTRODUCTION

Your sander has many features for making sanding operations more pleasant and enjoyable. Safety, performance, and dependability have been given top priority in the design of this sander making it easy to maintain and operate.



### CAUTION:

Carefully read through this entire operator's manual before using your new sander. Pay close attention to the Rules for Safe Operation and all Safety Alert Symbols including Danger, Warning, and Caution. If you use your sander properly and only for what it is intended, you will enjoy years of safe, reliable service.



### WARNING:



The operation of any sander can result in foreign objects being thrown into your eyes, which can result in severe eye damage. Before beginning power tool operation, always wear safety goggles or safety glasses with side shields and a full face shield when needed. We recommend Wide Vision Safety Mask for use over eyeglasses or standard safety glasses with side shields. Always wear eye protection which is marked to comply with ANSI Z87.1.



**Look for this symbol to point out important safety precautions. It means attention!!! Your safety is involved.**

# RULES FOR SAFE OPERATION

## GENERAL SAFETY RULES



### WARNING:

Read and understand all instructions. Failure to follow all instructions listed below, may result in electric shock, fire and/or serious personal injury.

## SAVE THESE INSTRUCTIONS

### WORK AREA

- **Keep your work area clean and well lit.** Cluttered benches and dark areas invite accidents.
- **Do not operate power tools in explosive atmospheres, such as in the presence of flammable liquids, gases, or dust.** Power tools create sparks which may ignite the dust or fumes.
- **Keep bystanders, children, and visitors away while operating a power tool.** Distractions can cause you to lose control.

### ELECTRICAL SAFETY

- **Double insulated tools are equipped with a polarized plug (one blade is wider than the other.) This plug will fit in a polarized outlet only one way. If the plug does not fit fully in the outlet, reverse the plug. If it still does not fit, contact a qualified electrician to install a polarized outlet. Do not change the plug in any way.** Double insulation  eliminates the need for the three wire grounded power cord and grounded power supply system.
- **Avoid body contact with grounded surfaces such as pipes, radiators, ranges and refrigerators.** There is an increased risk of electric shock if your body is grounded.
- **Don't expose power tools to rain or wet conditions.** Water entering a power tool will increase the risk of electric shock.
- **Do not abuse the cord. Never use the cord to carry the tools or pull the plug from an outlet. Keep cord away from heat, oil, sharp edges or moving parts. Replace damaged cords immediately.** Damaged cords increase the risk of electric shock.
- **When operating a power tool outside, use an outdoor extension cord marked "W-A" or "W".** These cords are rated for outdoor use and reduce the risk of electric shock.

## PERSONAL SAFETY

- **Stay alert, watch what you are doing and use common sense when operating a power tool. Do not use tool while tired or under the influence of drugs, alcohol, or medication.** A moment of inattention while operating power tools may result in serious personal injury.
- **Dress properly. Do not wear loose clothing or jewelry. Contain long hair. Keep your hair, clothing, and gloves away from moving parts.** Loose clothes, jewelry, or long hair can be caught in moving parts.
- **Avoid accidental starting. Be sure switch is off before plugging in.** Carrying tools with your finger on the switch or plugging in tools that have the switch on invites accidents.
- **Remove adjusting keys or wrenches before turning the tool on.** A wrench or a key that is left attached to a rotating part of the tool may result in personal injury.
- **Do not overreach. Keep proper footing and balance at all times.** Proper footing and balance enables better control of the tool in unexpected situations.
- **Use safety equipment. Always wear eye protection.** Dust mask, non-skid safety shoes, hard hat, or hearing protection must be used for appropriate conditions.

## TOOL USE AND CARE

- **Use clamps or other practical way to secure and support the workpiece to a stable platform.** Holding the work by hand or against your body is unstable and may lead to loss of control.
- **Do not force tool. Use the correct tool for your application.** The correct tool will do the job better and safer at the rate for which it is designed.
- **Do not use tool if switch does not turn it on or off.** Any tool that cannot be controlled with the switch is dangerous and must be repaired.
- **Disconnect the plug from the power source before making any adjustments, changing accessories, or storing the tool.** Such preventive safety measures reduce risk of starting the tool accidentally.
- **Store idle tools out of reach of children and other untrained persons.** Tools are dangerous in the hands of untrained users.
- **Maintain tools with care. Keep cutting tools sharp and clean.** Properly maintained tools, with sharp cutting edges are less likely to bind and are easier to control.
- **Check for misalignment or binding of moving parts, breakage of parts, and any other condition that may affect the tools operation. If damaged, have the tool serviced before using.** Many accidents are caused by poorly maintained tools.
- **Use only accessories that are recommended by the manufacturer for your model.** Accessories that may be suitable for one tool, may become hazardous when used on another tool.

# RULES FOR SAFE OPERATION

## GENERAL SAFETY RULES (cont'd)

### SERVICE

- **Tool service must be performed only by qualified repair personnel.** Service or maintenance performed by unqualified personnel could result in a risk of injury.
- **When servicing a tool, use only identical replacement parts. Follow instructions in Maintenance section of this manual.** Use of unauthorized parts or failure to follow Maintenance Instructions may create a risk of electric shock or injury.

### SPECIFIC SAFETY RULES

- **Hold tool by insulated gripping surfaces when performing an operation where the tool may contact hidden wiring or its own cord.** Contact with a "live" wire will make exposed metal parts of the tool "live" and shock the operator.
- **Never use this or any power sander for wet sanding or liquid polishing.** Failure to comply can result in electrical shock causing serious injury or worse.
- **Keep hands away from sanding area.**

### ADDITIONAL RULES FOR SAFE OPERATION

- **Know your power tool.** Read operator's manual carefully. Learn its applications and limitations, as well as the specific potential hazards related to this tool.
- **Always wear safety glasses.** Everyday eye-glasses have only impact-resistant lenses; they are **NOT** safety glasses.
- **Protect your lungs.** Wear a face or dust mask if the operation is dusty.
- **Protect your hearing.** Wear hearing protection during extended periods of operation.
- **Make sure your extension cord is in good condition.** When using an extension cord be sure to use one heavy enough to carry the current your product will draw. An undersized cord will cause a drop in line voltage resulting in loss of power and overheating. A wire gage size

(A.W.G.) of at least **16** is recommended for an extension cord 100 feet or less in length. A cord exceeding 100 feet is not recommended. If In doubt, use the next heavier gage. The smaller the gauge number, the heavier the cord.

- **Inspect tool cords periodically** and if damaged, have repaired at your nearest authorized service center. Stay constantly aware of cord location.
- **Check damaged parts.** Before further use of the tool, a guard or other part that is damaged should be carefully checked to determine that it will operate properly and perform its intended function. Check for alignment of moving parts, binding of moving parts, breakage of parts, mounting, and any other conditions that may affect its operation. A guard or other part that is damaged should be properly repaired or replaced by an authorized service center.
- **Inspect for** and remove all nails from lumber before sanding.
- **Save these instructions.** Review them frequently and use them to instruct others who may use this tool. If you loan someone this tool, loan them these instructions also.



#### WARNING:

Some dust created by power sanding, sawing, grinding, drilling, and other construction activities contains chemicals known to cause cancer, birth defects or other reproductive harm. Some examples of these chemicals are:

- lead from lead-based paints,
- crystalline silica from bricks and cement and other masonry products, and
- chromium from chemically-treated lumber.

Your risk from these exposures varies, depending on how often you do this type of work. To reduce your exposure to these chemicals, work in a well ventilated area, and work with approved safety equipment, such as those dust masks that are specially designed to filter out microscopic particles.

## SAVE THESE INSTRUCTIONS

# SYMBOLS

SYMBOL	NAME	DESIGNATION/EXPLANATION
V	Volts	Voltage
A	Amperes	Current
Hz	Hertz	Frequency (cycles per second)
min	Minutes	Time
~	Alternating Current	Type or a characteristic of current
— — —	Direct Current	Type or a characteristic of current
$n_0$	No Load Speed	Rotational speed, at no load
□	Class II Construction	Designates Double Insulated Construction Tools
.../min	Revolutions or Reciprocation Per Minute	Revolutions, strokes, surface speed, orbits etc. per minute
	Safety Alert Symbol	Indicates danger, warning or caution. It means attention!!! You safety is involved.

The purpose of safety symbols is to attract your attention to possible dangers. The safety symbols, and the explanations with them, deserve your careful attention and understanding. The safety warnings do not by themselves eliminate any danger. The instructions or warnings they give are not substitutes for proper accident prevention measures.

SYMBOL	MEANING
	<b>SAFETY ALERT SYMBOL:</b> Indicates danger, warning, or caution. May be used in conjunction with other symbols or pictographs.
	<b>DANGER:</b> Failure to obey a safety warning will result in serious injury to yourself or to others. Always follow the safety precautions to reduce the risk of fire, electric shock and personal injury.
	<b>WARNING:</b> Failure to obey a safety warning can result in serious injury to yourself or to others. Always follow the safety precautions to reduce the risk of fire, electric shock and personal injury.
	<b>CAUTION:</b> Failure to obey a safety warning may result in property damage or personal injury to yourself or to others. Always follow the safety precautions to reduce the risk of fire, electric shock and personal injury.
<b>NOTE:</b>	Advises you of information or instructions vital to the operation or maintenance of the equipment.

# FEATURES

## KNOW YOUR SANDER

See Figure 1.

Before attempting to use your sander, familiarize yourself with all operating features and safety requirements.



### WARNING:

If any parts are missing do not operate your sander until the missing parts are replaced. Failure to do so could result in possible serious injury.

## SWITCH

This tool is equipped with a simple switch control. To turn your sander **ON**, depress the switch button as shown in Figure 1. Depress the switch button in the opposite direction to turn your sander **OFF**.

## VELCRO® PAD

Hook and loop design allows for quick change of sanding sheets and scrubbing pads and also enables you to reuse them.

## TRIANGULAR SANDING SHEETS

The top two-thirds of each sanding sheet is a detachable triangle that can be rotated to extend sheet life and promote even wear.

## CIRCULAR SANDING ACTION

Your sander uses very quick, small circular motions to remove material. The motion is ideal for producing a fine finished grain or, when using the scrubbing pad, removing light rust, paint and other build up from the work surface.



### WARNING:

Do not allow familiarity with your sander to make you careless. Remember that a careless fraction of a second is sufficient to inflict severe injury.

## APPLICATIONS

(USE ONLY FOR THE PURPOSES LISTED BELOW)

- Sanding on wood surfaces.
- Removing rust from and sanding steel surfaces.
- Polishing and scrubbing metal and tile.



### CAUTION:

Keep the cord away from the sanding area and position it so that it will not be caught on lumber, tools, or other objects during sanding.

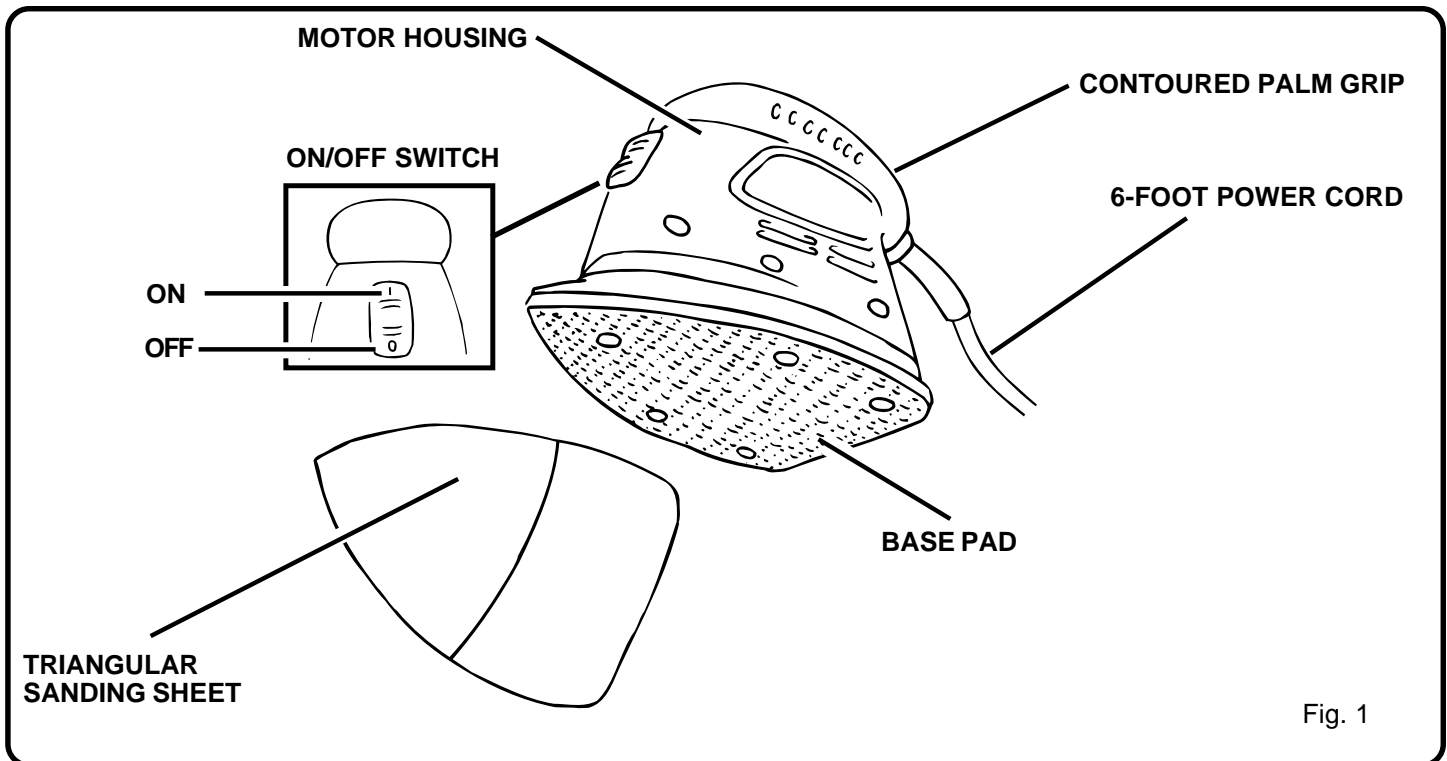

Fig. 1

\*VELCRO® is a registered trademark of VELCRO U.S.A. Inc.

# FEATURES

## DOUBLE INSULATION

Your Ryobi power tool is double insulated. This means you are separated from the tool's electrical system by two complete sets of electrical insulation. This extra layer of insulation is intended to protect the user from electrical shock due to a break in the wiring insulation. All exposed metal parts are isolated from the internal metal motor components with protecting insulation. Double insulated tools do not need to be grounded.



### WARNING:

The double insulated system is intended to protect the user from shock resulting from a break in the tool's internal wiring. Observe all normal safety precautions related to avoiding electrical shock.

# UNPACKING

Your sander has been shipped completely assembled and ready for use. *See Figure 2.* Inspect it carefully to make sure no breakage or damage has occurred during shipping. If any parts are damaged or missing, contact your nearest authorized service center to obtain replacement parts before attempting to operate sander.

- Carefully lift sander from the carton and place it on a level work surface.
- Do not discard the packing materials until you have carefully inspected the sander, identified all parts, and satisfactorily operated your new sander.



### WARNING:

If any parts are damaged or missing, do not operate your sander until the parts are replaced. Failure to do so could result in possible serious personal injury.



### WARNING:

To prevent accidental starting or electrical shock that could cause possible serious personal injury, assemble all parts to your sander before connecting it to power supply. Sander should never be connected to power supply when you are assembling parts, making adjustments, installing or removing sanding sheets, cleaning, or when not in use.

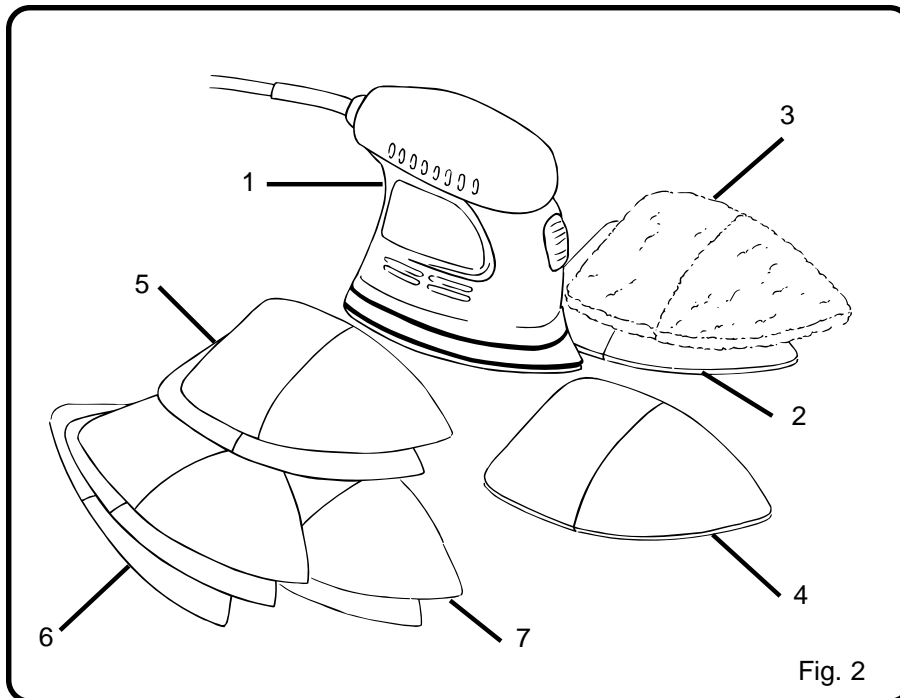

## PACKING LIST:

1. Sander
2. Light Scrubbing pad (White) (1)
3. Heavy Duty Scrubbing pad (Red) (1)
4. Polishing pad (Gray) (1)
5. 60-grit sanding sheets (2)
6. 120-grit sanding sheets (3)
7. 240-grit sanding sheets (2)
8. Operator's Manual (1)  
(Not shown)
9. Warranty and Registration Card (1)  
(Not shown)

# OPERATION



## WARNING:

Failure to unplug your sander could result in accidental starting causing possible serious personal injury.

## SELECT THE PROPER SANDING SHEET/ SCRUBBING PAD

Selecting the correct size grit and type sanding sheet is an extremely important step in achieving a high quality sanded finish. Aluminum oxide, silicon carbide, and other synthetic abrasives are best for power sanding. Natural abrasives, such as flint and garnet are too soft for economical use in power sanding.

In general, coarse grit will remove the most material and finer grit will produce the best finish in all sanding operations. The condition of the surface to be sanded will determine which grit will do the job. If the surface is rough, start with a coarse grit and sand until the surface is uniform. Medium grit may then be used to remove scratches left by the coarser grit and finer grit used for finishing of the surface. Always continue sanding with each grit until surface is uniform.

Sheet/Pad	Recommended Use
Red scrubbing pad	Paint and rust removal
White scrubbing pad	Light scrubbing and cleaning
Polishing pad	Polishing finished surfaces
60-grit sanding sheet	Coarse sanding
120-grit sanding sheet	Light sanding
240-grit sanding sheet	Finish sanding



## WARNING:

Your sander should never be connected to power supply when you are making adjustments, installing or replacing sanding sheets or pads, cleaning, or when not in use. Disconnecting your sander will prevent accidental starting that could cause serious personal injury.



## WARNING:

Never use your sander for wet sanding or liquid polishing. Failure to comply can result in electrical shock and possible serious injury.

## ATTACH SANDING SHEET/SCRUBBING PAD

Align the bottom of the sanding sheet or scrubbing pad with the bottom base of your sander. Working your way up to the tip of the base, press the sheet firmly onto the base pad. See Figure 3.

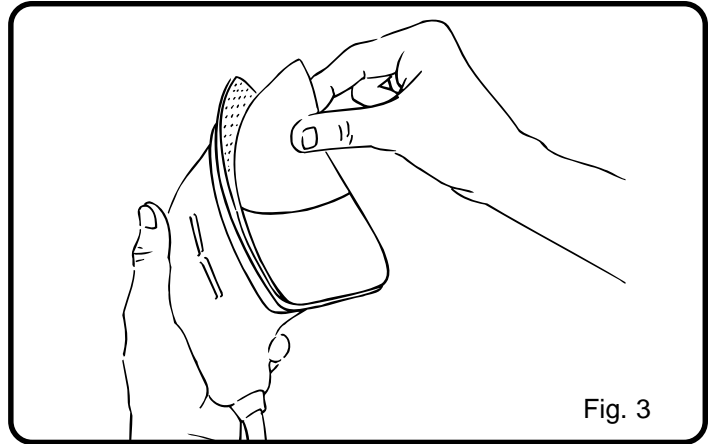

Fig. 3

When correctly positioned, the outer edges of the sanding sheet or scrubbing pad will line up with outer edges of the base pad.

To replace sanding sheets or scrubbing pads, simply pull the old sheet or pad off the base pad and attach a new one as described above.

## ROTATING THE SANDING SHEETS

The majority of wear in a precision sanding application occurs at the tip of the sanding sheet. The unique design of the sanding sheets and scrubbing pads allows you to detach and rotate the top two thirds of each and extend the life of the pad or sheet.

To rotate the top of the pad or sheet, simply remove the top two thirds along the perforation. Rotate the pad or sheet so that a clean corner is located at the tip of the base pad. See Figure 4. Press the pad or sheet firmly onto the base pad.

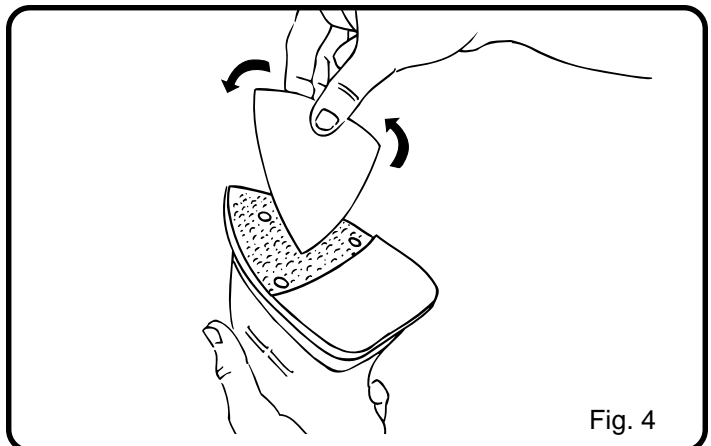

Fig. 4



# OPERATION

## **WARNING:**

Do not wear loose clothing or jewelry when operating sander. They could get caught in moving parts causing serious injury. Keep head away from sander and sanding area. Hair could be drawn into sander causing serious injury.

## **WARNING:**

Always wear safety goggles or safety glasses with side shields marked to comply with ANSI Z87.1 during power tool operation or when blowing dust. If operation is dusty, also wear a dust mask.

## OPERATING YOUR SANDER

Hold your sander by the palm gripping surface, making sure not to cover the air vents with your hand. Using your forefinger, turn the **ON/OFF** switch to the **ON** position.

## **CAUTION:**

Be careful not to let your hand cover the air vents.

Hold sander in front and away from you, keeping it clear of the workpiece. Start sander and let the motor build to its maximum speed, then gradually lower the sander onto the workpiece. Move the sander slowly across the workpiece using small circular motions. *See Figure 5.*

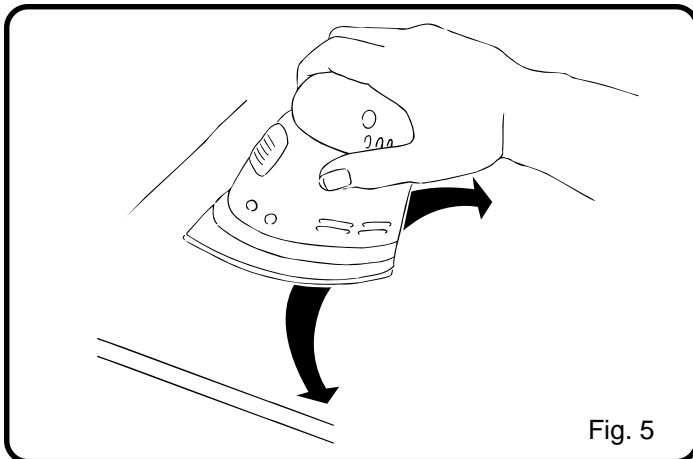

**DO NOT FORCE.** The weight of the unit supplies adequate pressure, so let the sandpaper and the sander do the work. Applying additional pressure only slows the motor, rapidly wears the sandpaper and greatly reduces sander speed. Excessive pressure will overload the motor, causing possible damage from motor overheating and can result in inferior work. Any finish or resin on wood may soften from the frictional heat. Do not allow sanding on one spot too long as sander's rapid action may remove too much material, making the surface uneven.

For detail sanding such as corners and crevices, use the tip of the sanding pad with small back and forth motions. *See Figure 6.*

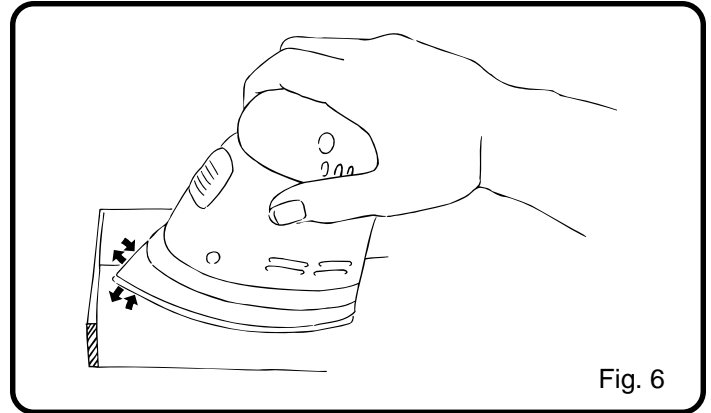

# MAINTENANCE



## WARNING:

When servicing use only identical Ryobi replacement parts. Use of any other parts may create a hazard or cause product damage.



## WARNING:

Always remove scrubbing pad or sanding sheet from sander before cleaning. Failure to do so could cause serious personal injury.

### IMPORTANT

Servicing of a tool with double insulation requires extreme care and knowledge of the system and should be performed only by a qualified service technician. For service we suggest you return the tool to your nearest **RYOBI AUTHORIZED SERVICE CENTER** for repair. When servicing use only identical Ryobi replacement parts.

### GENERAL

Avoid using solvents when cleaning plastic parts. Most plastics are susceptible to damage from various types of commercial solvents and may be damaged by their use. Use clean cloths to remove dirt, carbon dust, etc.



## WARNING:

Do not at any time let brake fluids, gasoline, petroleum-based products, penetrating oils, etc. come in contact with plastic parts. They contain chemicals that can damage, weaken, or destroy plastic.

When electric tools are used on fiberglass boats, sports cars, wallboard, spackling compounds, or plaster, it has been found that they are subject to accelerated wear and possible premature failure, as the fiberglass chips and grindings are highly abrasive to bearings, brushes, commutators, etc. Consequently, it is not recommended that this tool be used for extended work on any fiberglass material, wallboard, spackling compounds, or plaster. During any use on fiberglass it is extremely important that the tool is cleaned frequently by blowing with an air jet.

### LUBRICATION

All of the bearings in this tool are lubricated with a sufficient amount of high grade lubricant for the life of the unit under normal operating conditions. Therefore, no further lubrication is required.

### CLEANING THE SCRUBBING PADS

To ensure longer life and optimum performance, periodically clean all residue and foreign materials from the scrubbing pads. This can be done simply by rinsing the pad with warm water until all foreign material has been washed away. After cleaning, gently squeeze the pad to remove excess water and allow pad to dry. Always store pads and sanding sheets flat in a cool dry location.

### CLEANING THE SANDING SHEETS

The sanding sheets that came with your sander are made to be re-used. Therefore, it is important that they be cleaned periodically to remove sanding residue and foreign material that can accumulate over time. To clean sanding sheets, rub the sheets with a gum rubber block.





# OPERATOR'S MANUAL

## Compact Finishing Sander

### Model CFS1500

#### Double Insulated

### EXTENSION CORD CAUTION

When using a power tool at a considerable distance from a power source, be sure to use an extension cord that has the capacity to handle the current the tool will draw. An undersized cord will cause a drop in line voltage, resulting in overheating and loss of power. Use the chart to determine the minimum wire size required in an extension cord. Only round jacketed cords should be used.

When working with a tool outdoors, use an extension cord that is designed for outside use. This is indicated by the letters "WA" on the cord's jacket.

Before using any extension cord, inspect it for loose or exposed wires and cut or worn insulation.

\*\*Ampere rating

(on tool data plate) 0-2.0 2.1-3.4 3.5-5.0 5.1-7.0 7.1-12.0 12.1-16.0

Cord Length	Wire Size (A.W.G.)					
25'	16	16	16	16	14	14
50'	16	16	16	14	14	12
100'	16	16	14	12	10	—

 **CAUTION:**

Keep the extension cord clear of the working area. Position the cord so that it will not get caught on workpiece, tools, or other obstructions while you are working with a power tool.

*\*\*Used on 12 gauge - 20 amp circuit.*

### • SERVICE

Now that you have purchased your tool, should a need ever exist for repair parts or service, simply contact your nearest Ryobi Authorized Service Center. Be sure to provide all pertinent facts when you call or visit. Please call 1-800-525-2579 for your nearest Ryobi Authorized Service Center. You can also check our web site at [www.ryobitools.com](http://www.ryobitools.com) for a complete list of Authorized Service Centers.

### • MODEL NO. AND SERIAL NO.

The model number and serial number of this tool will be found on a plate attached to the motor housing.

Please record the serial number in the space provided below.

- MODEL NUMBER CFS1500
- SERIAL NUMBER \_\_\_\_\_

### Ryobi Technologies Inc.

1428 Pearman Dairy Road, Anderson, SC 29625  
 Post Office Box 1207, Anderson, SC 29622-1207  
 Phone 1-800-525-2579  
[www.ryobitools.com](http://www.ryobitools.com)