

OWNER'S MANUAL

Palsonic

**61CM CORDLESS REMOTE COLOUR TELEVISION
MODEL: 6140GY**



Type Tested
Electrical
Safety
AS/NZS 3250 Lic 4166
Standards Australia
APP No: N16712

**PALSONIC CORPORATION PTY LTD
1 JOYNTON AVENUE
WATERLOO NSW 2017 AUSTRALIA
TEL: (02) 9313 7111
FAX: (02) 9313 7555
www.palsonic.com.au**

**PALSONIC CUSTOMER SERVICE
TELEPHONE
AUSTRALIA: 1300 657 888**

Congratulations on your purchase of this Palsonic colour television receiver.

We recommend that you thoroughly read this manual before use to fully enjoy the many functions and excellent effects of this receiver.

Retain this manual in an easily accessible location for future reference.

* Screen displays and illustrations in this manual may differ from the actual ones for better visibility.

Contents

Main Features	1
Important Safety Cautions	2
Identification of Controls	4
Installation	6
Connection	8
Turning On/Off	10
Selecting Input Signal	11
Tuning In	12
Channel Selection	15
Picture Adjustments	17
Sound Adjustments	18
System Setup	20
Timer Setting	22
Playing Games	24
Troubleshooting Guide	25
Specifications	26

Main features

- **Hyperband**
- **256 preset channels**
- **Automatic channel preset**
- **Intellectualized I²C-bus control**
- **English/Chinese on-screen display**
- **Full function remote control**
- **AV input & output terminals**
- **Clock/Game/Calendar**
- **Four picture modes**
- **Four sound modes**
- **ON timer/OFF timer**
- **Surround sound**
- **Channel scan**
- **Channel edit**

Important Safety Precautions

Safety Precautions

- ◆ *When any unusual situation occurs, turn off the power supply at once and remove the plug from the wall outlet. Contact a qualified service department in your local area.*

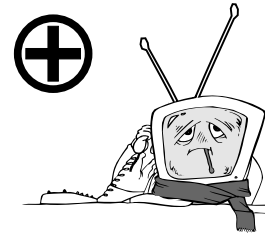

- ◆ *Do not expose the TV set to rain or excessive moisture. Avoid using the set in very warm or damp places and never use it in a bathroom.*



- ◆ *When cleaning dust off the picture tube disconnect the power first. You can wipe lightly with a piece of dry, clean and soft cloth.*

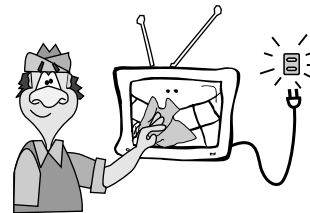

- ◆ *Avoid exposing the set to direct sunlight and other sources of heat to prevent damage to the cabinet and components.*

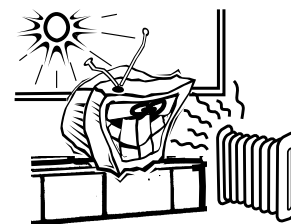

- ◆ *High voltage exists in this TV set. Do not remove the cover.*

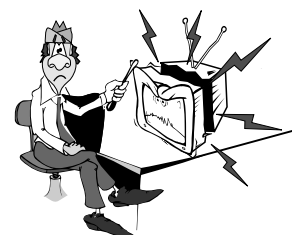

⚠ This TV set can operate on a power of ~240V, 50Hz. You must not use a power supply of any other type.

◆ Do not cover the ventilating hole in the cabinet
Keep a space of more than 10cm from the walls to the TV set to ensure adequate ventilation.

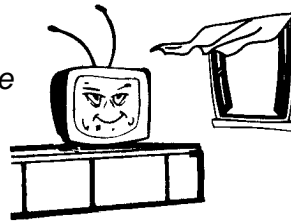

◆ If the power cord or the plug is damaged contact a qualified service department for service.

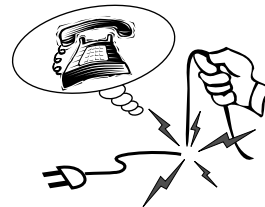

◆ When the TV set is to be left unattended for a long period of time, turn off the power supply and remove the plug from the wall outlet.

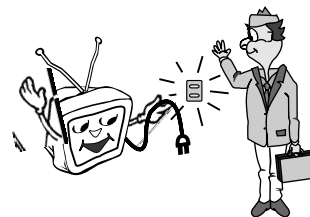

◆ Don't overload wall outlets; extension cords, or integral convenience receptacles as this can result in a risk of fire or electric shock.

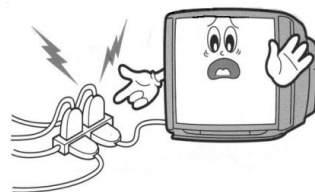

◆ Don't try to push anything into the cabinet or place any vessel with water on the TV set.

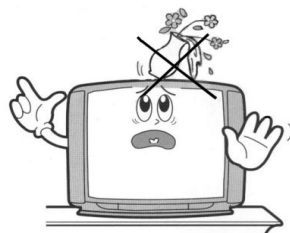

Identification of Controls

Front/Back view

Front

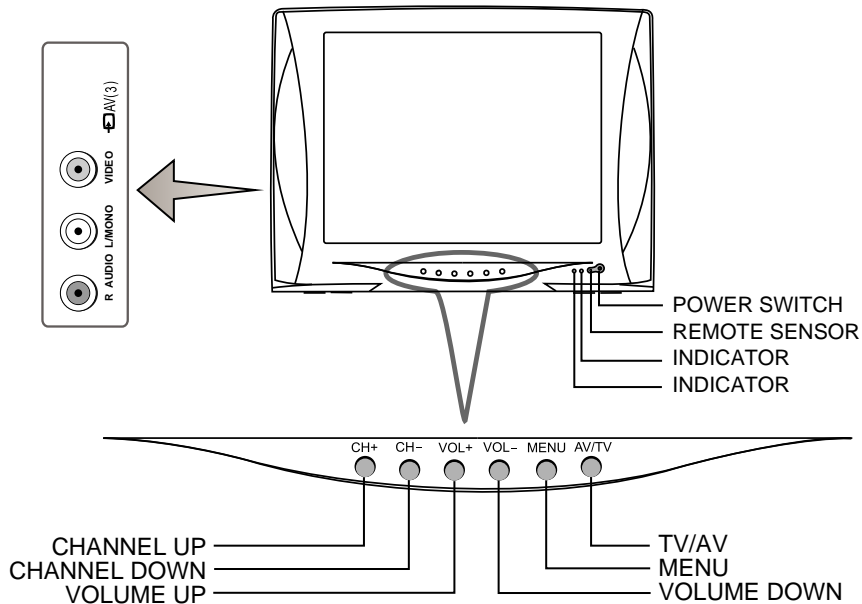

Back

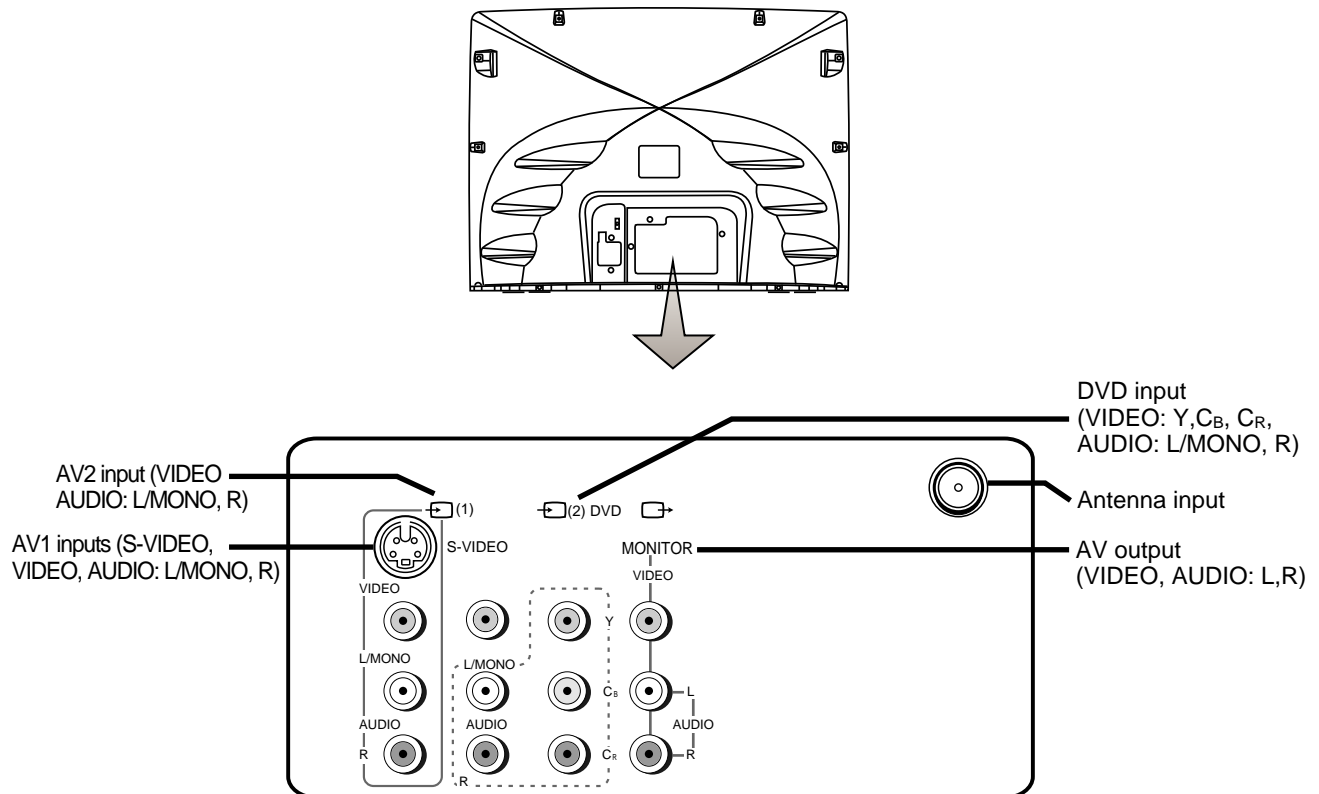

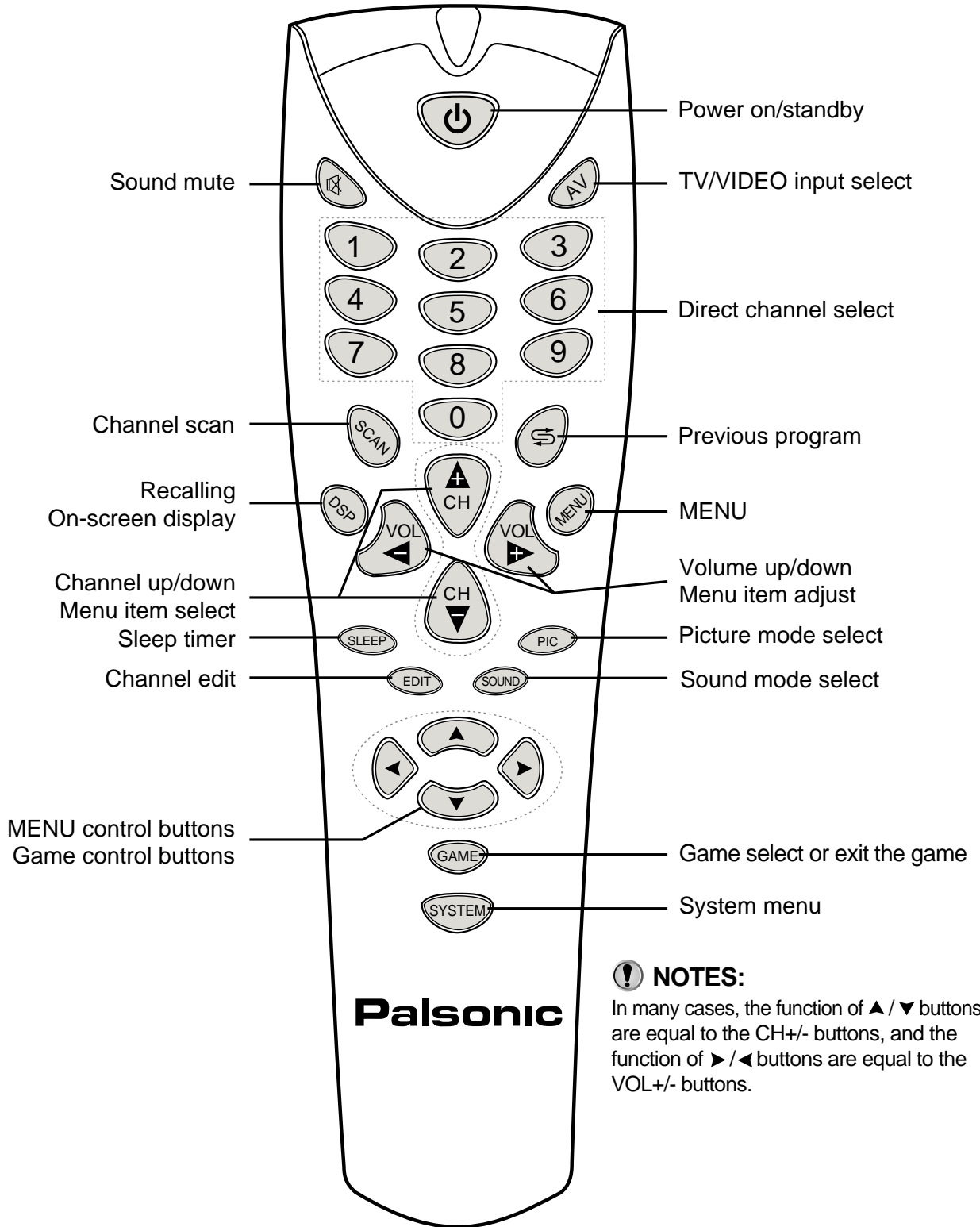

NOTES:

In many cases, the function of ▲/▼ buttons are equal to the CH+/- buttons, and the function of ►/◄ buttons are equal to the VOL+/- buttons.

Installation

INSTALL the unit in a room where direct light will not fall upon the screen. Total darkness or a reflection on the picture screen may cause eyestrain. Soft and indirect lighting is recommended for comfortable viewing.

Antenna connection/Battery installation

Antenna connection

Optimum reception of colour requires a good signal and will generally mean that an outdoor aerial must be used. The exact type and position of the aerial will depend upon your particular area.

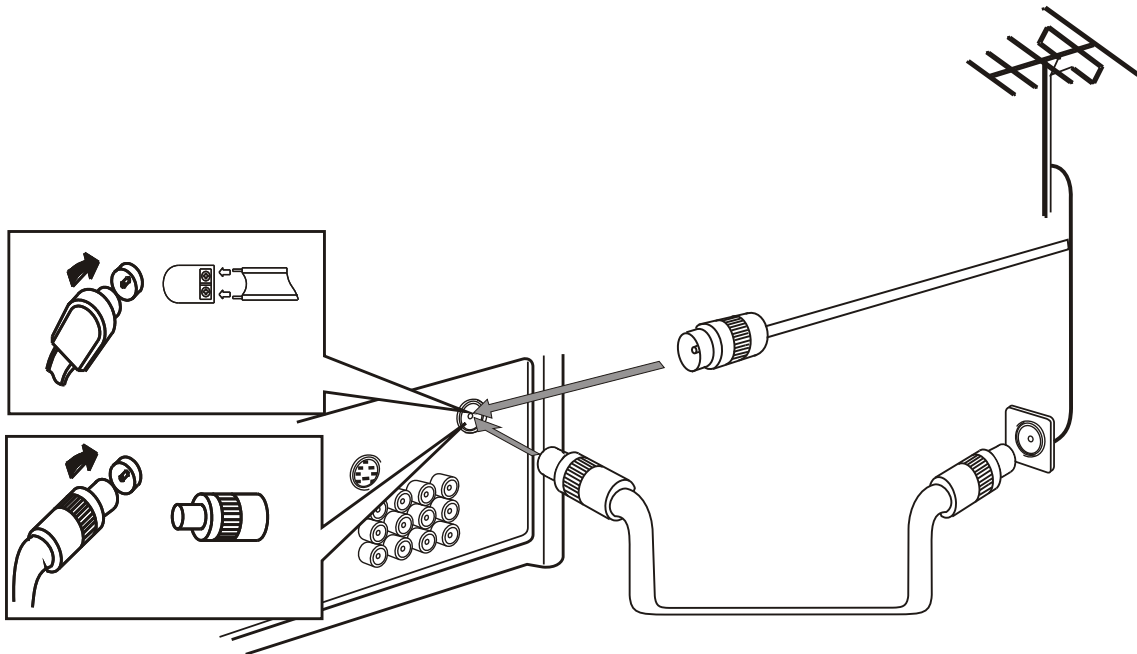

! NOTES:

- It is recommended that the 75-ohm coaxial cable be used to eliminate interference and noise which may occur due to radio wave conditions.
- The aerial cable should not be bundled with the power cord and the like.

Installing batteries

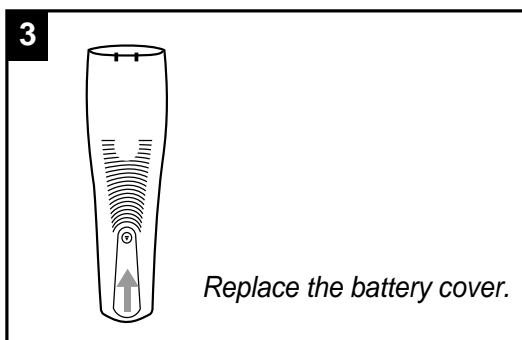
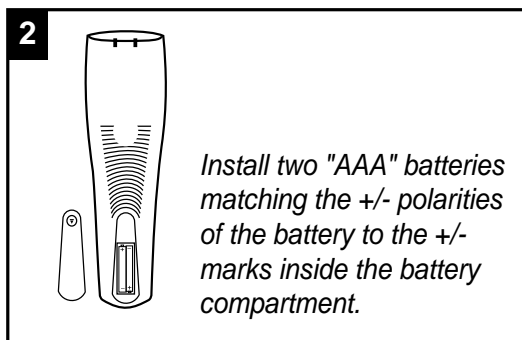
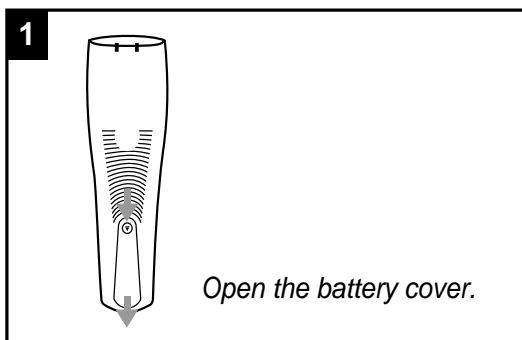

! NOTES:

- Do not try to recharge batteries not intended to be recharged.
- Use only the size and type of batteries specified. Do not mix different types of batteries together or old batteries with fresh ones.
- When the remote control will not be used for a long period of time or when the batteries are worn out, remove the batteries.
- Do not throw the batteries into a fire. Dispose of used batteries in the specified manner.
- Do not drop, dampen or disassemble the remote control.

Effective range of the Remote Control

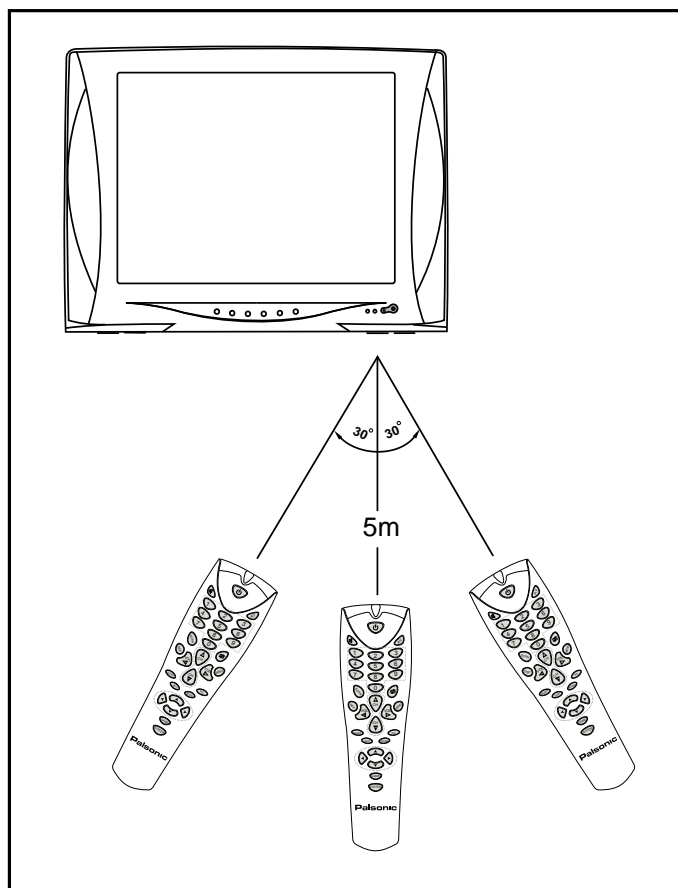

! NOTES:

- When there is an obstacle between the TV and the transmitter, the transmitter may not operate.
- When direct sunlight, and incandescent lamp, fluorescent lamp or any other strong light shines on the REMOTE SENSOR of the TV the remote operation may be unstable.

External Equipment Connection

(Please refer to the owner's manual of the equipment to be connected as well.)

External Equipment Connection

To connect AV input terminals

You can connect video equipment such as a VTR and video camera to this TV and enjoy the high quality picture and sound.

If your video equipment has a S-VIDEO output terminal, connect it to the S-VIDEO input terminal (special (S-VIDEO type) of the unit. If not, connect it to the VIDEO terminal (RCA).

The S-VIDEO and AV1 use the same group of audio input terminals, and the S-VIDEO input terminal has priority over the AV1 VIDEO terminal. To use equipment connected to the VIDEO terminal, disconnect any plug from the S-VIDEO terminal.

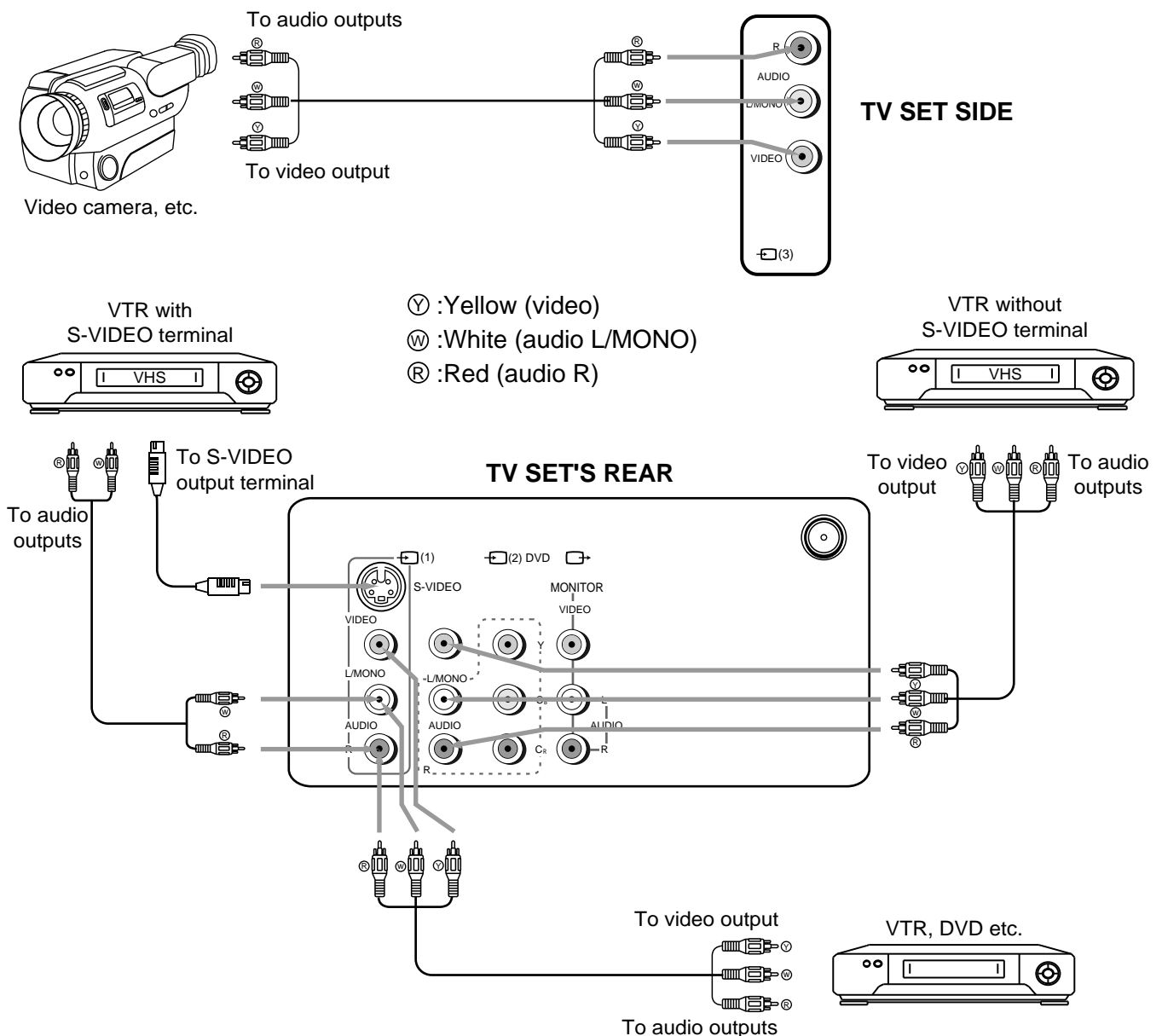

To connect DVD input terminals

The figure below shows how to connect the DVD input terminals of the TV set to the DVD Player, Laser Disc Player, etc.

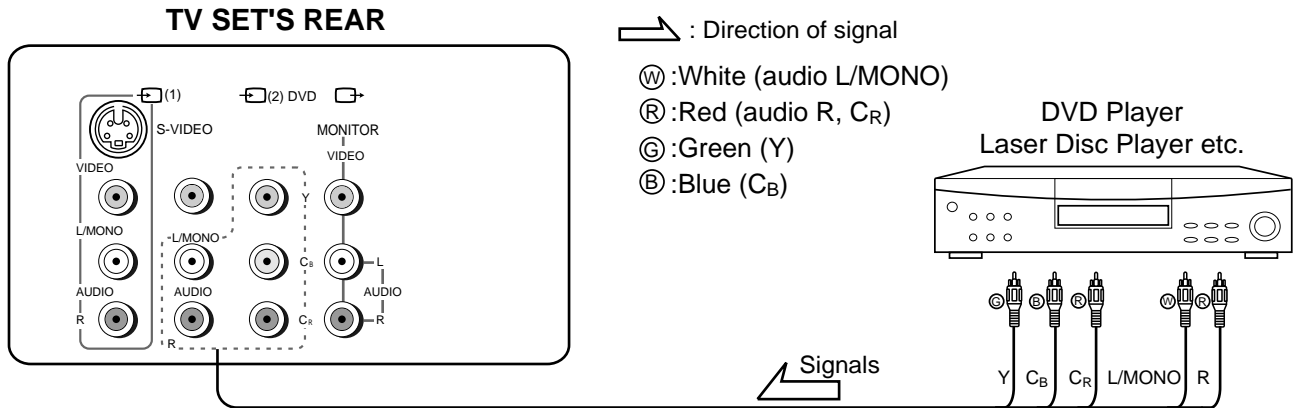

! NOTES:

1. Both the C_R terminal and the audio R terminal are red for easy identification. Make sure they are correctly connected.
2. DVD and AV2 use the same group of audio terminals.
3. DVD has a priority over AV2. If you use DVD input, disconnect VIDEO2.

To connect AV output terminals

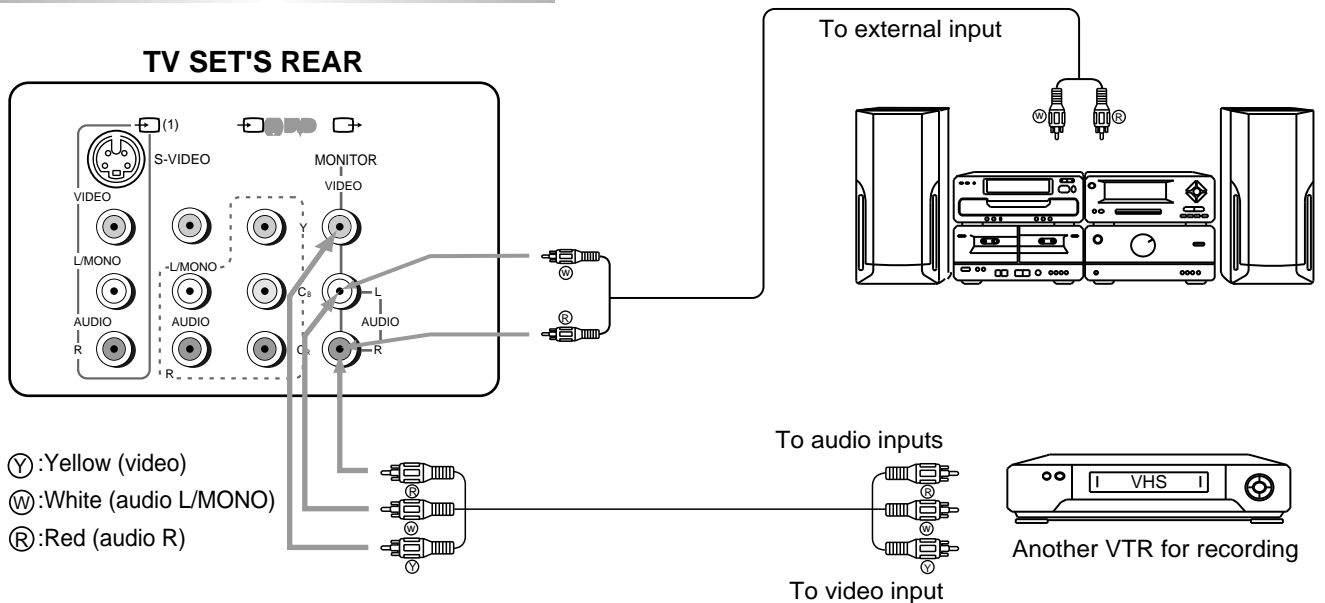

Turning on/off

Turning on/off

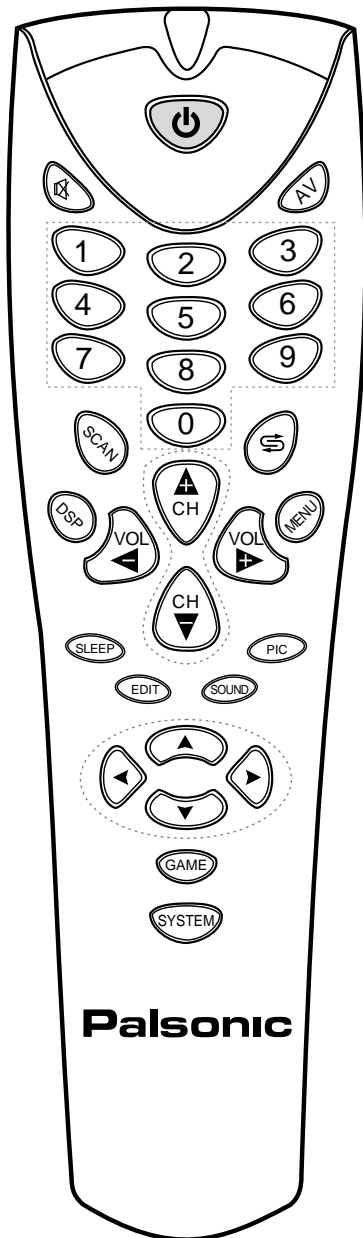

Turning on

- 1** Press the Power Switch on the TV set, the red indicator lights up, the set is in standby mode.
- 2** Press the  button on the remote control and the TV set is turned on.
- 3** In STANDBY mode, you can also press the Channel up button on the set to turn on.

! NOTES:

If there is no input signal, then a blueback appears. After 15 minutes, the set auto goes to STANDBY.

Turning off

- 1** Press the Power Switch on the TV set if you want to cut off the power completely.
- 2** If you want to turn off the TV set temporarily, press the  button on the remote control.

! NOTES:

The TV set can turn off automatically by:

- A. Sleep** timer function (needs to be set in advance).
- B. OFF** timer function (needs to be set in advance).

Select input signal

Select input signal

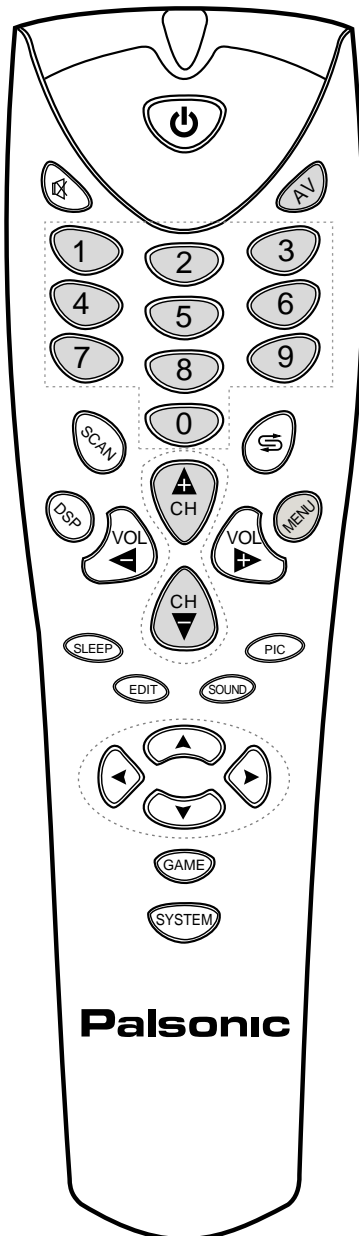

Watching AV program

This TV set provides AV input terminals for your convenient connection to VCR, DVD or other video equipment.

- 1 To watch video program from AV inputs, Press AV button repeatedly until you see the appropriate input indicator on the screen.**

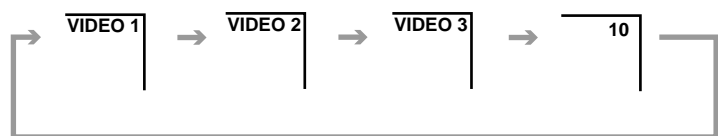

Notes:

When S-VIDEO terminal is used, the OSD (on-screen display) is S-VIDEO1 instead of VIDEO1.

When DVD is used, the OSD is DVD instead of VIDEO 2.

Switching from AV to TV

When the TV set is in AV mode, there are three ways for you to switch back to TV mode as follows.

- 1 Press AV button repeatedly until the TV program appears.**
- 2 Press digit buttons to switch to a desired TV program.**
- 3 Press CH+/- button to switch to TV mode.**

Tuning in

Auto search/Manual search/To skip unwanted channel

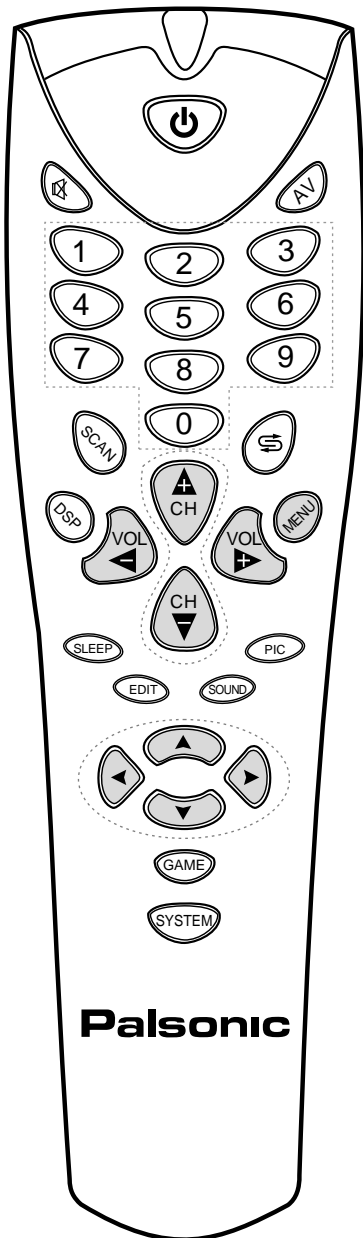

If you have preset the channels, you can directly watch TV programs after turning on the set. If not, then preset channels in one of the following ways.

Auto search

- 1** Enter into **TUNING** menu.
- 2** Press **CH+/-** to select **AUTO MEMORY**.
- 3** Press **VOL+** to start Auto Search. All active channels will be preset and stored into the memory automatically. After auto search, the TV will go to the first channel. During the process of Auto search, pressing **VOL-** will stop the process and the TV will return to the first channel.

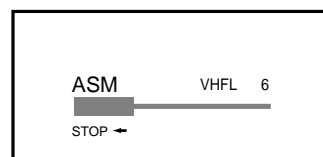
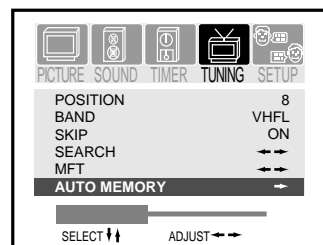
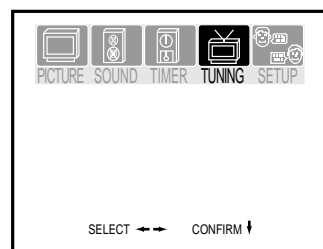

Manual search

If auto search can not preset the desired channels, or you want to preset the desired channels one by one with the preferred channel numbers, please make use of Manual Search.

- 1** Enter into **TUNING** menu.
- 2** Press **CH+/-** to select **POSITION** item.
- 3** Press **VOL+/-** to select a number (from 0~255). (You can press and hold the button to increase or decrease the value by 10).
- 4** Press **CH-** to select **SEARCH** item.

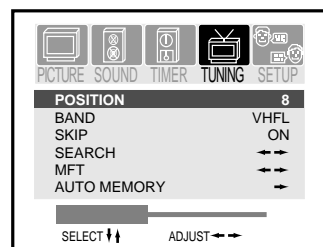

1 Press **MENU** button.

2 Press **VOL+/-** to select **TUNING** icon.

3 Press **CH-** to enter into **TUNING** menu.

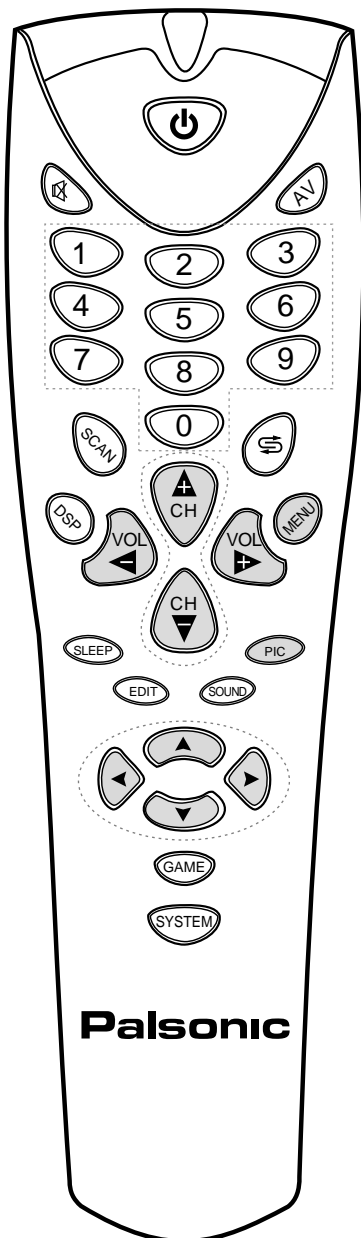
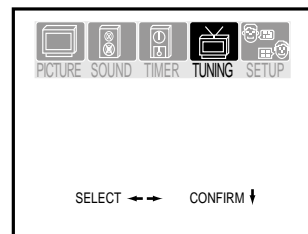

5 Press **VOL+** to search towards higher frequency, the screen displays glittering "→" press **VOL-** to search toward lower frequency, the screen displays glittering "←". When a channel is located, the searching stops and the channel is stored in the specified channel number.

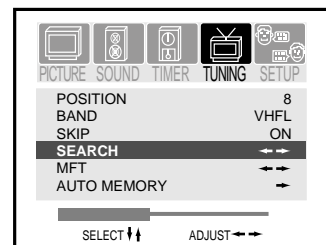

When searching towards higher frequency, pressing **VOL-** will stop the search and return to first program. When searching towards lower frequency, pressing **VOL+** will stop the search and return to first program.

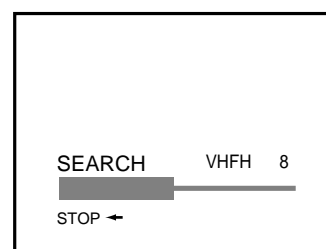

You can also use **BAND** selection to quicken searching process if you know which band your desired program locates in. The band switched among UHF, VHFL, VHFH. Repeat the above steps if you want to store another program in other position number.

To skip an unnecessary channel

After presetting the channels, you may skip unnecessary channels so that only the channels you want to watch are selected with **CH+/-** button.

1 From **TUNING** menu select an unwanted channel number (for example, channel 10).

2 Press **CH+/-** to select **SKIP** item.

3 Press **VOL+/-** to set **ON**. Now channel 10 will be skipped when you browse channels by **CH+** or **CH-** button.

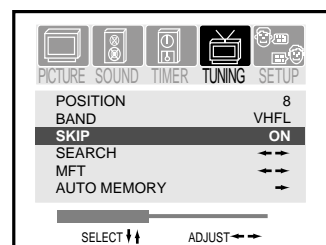

To restore a skipped channel, please select the channel number from **Tuning** menu, repeat the above steps to set **SKIP** item to **OFF**.

Tuning in (continued)

Fine tuning/The setting of colour and sound system

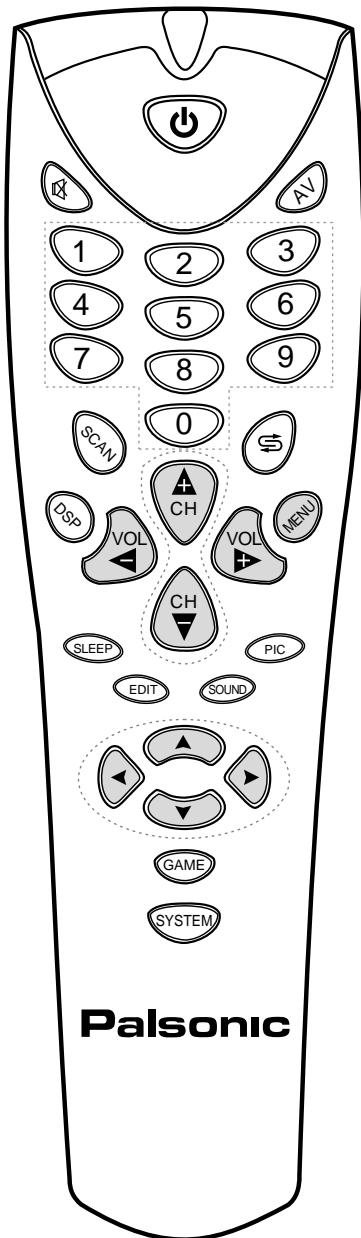

Fine tuning

Fine tuning is not necessary under normal conditions. However, in area of inferior broadcast conditions where adjustment is necessary for a better picture and sound, use Fine Tuning.

- 1** Enter into **TUNING** menu.
- 2** Press **CH+/-** to select **MFT**.
- 3** Press **VOL+** or **VOL-** to fine tune until the best possible picture and sound are obtained.

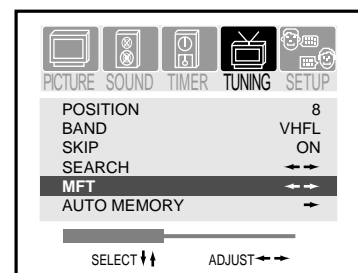

Note: if some channel's colour or sound is abnormal, it may be that the setting of colour or sound system is wrong, please do the following adjustment to set the proper colour and sound system.

The setting of colour and sound system

In factory the TV set's colour system has been preset to AUTO. If you want to change the system, please do the following steps:

Press **SYSTEM** button to display the colour and sound system menu.

- 1** If the picture's colour is abnormal, enter into the **SYSTEM** menu, press **CH+/-** to select **COLOR**, press **VOL+/-** to select a proper colour system.

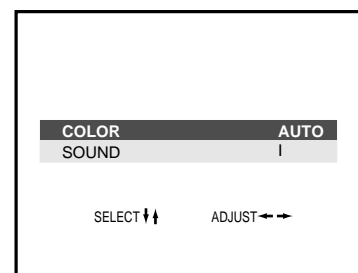

- 2** If the sound is abnormal. enter into the **SYSTEM** menu, press **CH+/-** to select **SOUND**, press **VOL+/-** to select a proper sound system.

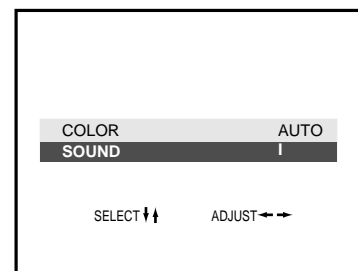

In some model there is only one sound system and in this case the sound system does not need to be adjusted.

Channel selection

Making use of direct select buttons

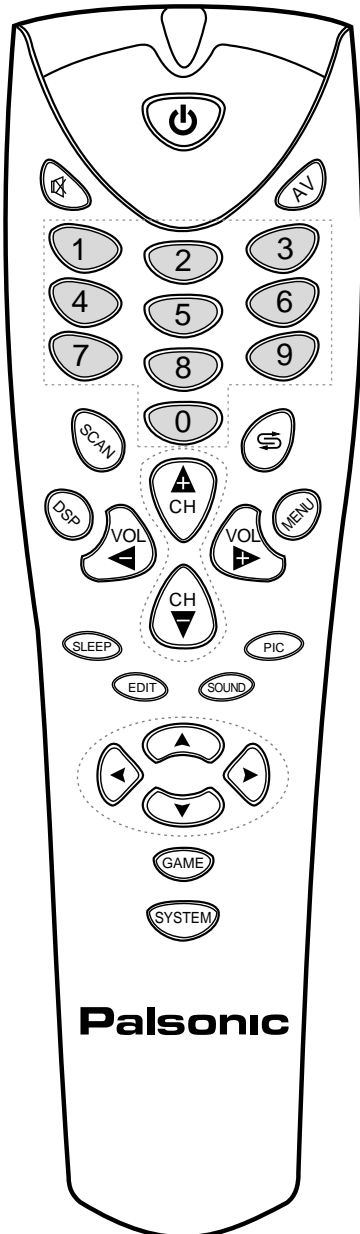

Use direct selection buttons

1 To select one-digit channel

Method 1: press 0-9 button and wait for 2 seconds.

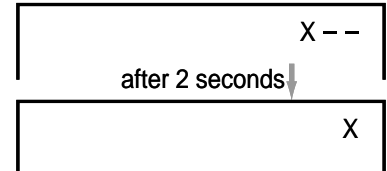

Method 2: press 0 button twice, and then press the channel number. Be sure the period of two-press should be within 2 seconds.

Method 3: press 0 button, then input the number and wait for 2 seconds. Be sure the period of two-press should be within 2 seconds.

2 To select two-digit channel

Method 1: Input the channel number using the digit buttons and wait for 2 seconds. Be sure the period of two-press should be within 2 seconds.

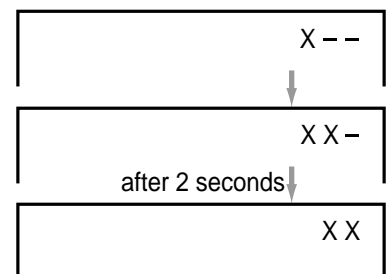

Method 2: press 0 button, and then input the channel number. Be sure the period of two-press should be within 2 seconds.

3 To select three digit channel

Just input the channel number. Be sure the period of two-press should be within 2 seconds.

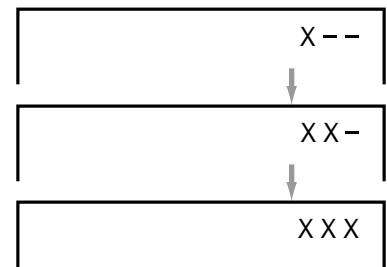

Note: the maximum channel number is 255.

Channel selection (continued)

Making use of channel up/down buttons/Previous channel button/Channel scan/channel edit

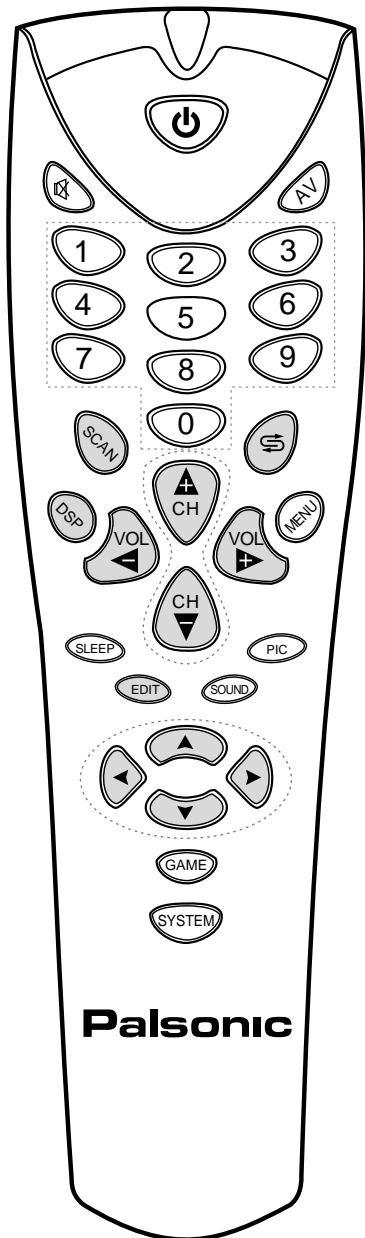

3

You can press DSP button twice to display the current time of the TV set, press again to cancel.

Use Channel up/down buttons

- 1 Press **CH+** button, the channel number increases.
- 2 Press **CH-** button, the channel number decreases.

Use Previous channel button

Press **⌘** button to switch between the current channel and the previous channel.

For example, the channel you previously watched is 11, the current channel is 2, press the button, it will return to channel 11, press the button again it will return to channel 2.

Channel scan

Press **SCAN** button, the set will scan the channel from the current channel to higher channels one by one until all the programs are scanned over and then stop. During scanning, pressing any button will stop it and the screen will settle at the current scanned program.

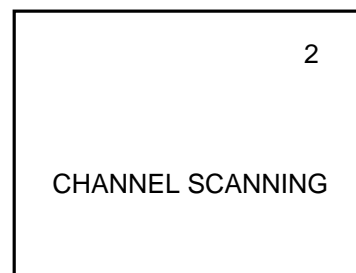

Channel edit

- 1 Press **EDIT** button to display **CHANNEL EXCHANGE** menu.
- 2 Press **CH+/-** to select **CHANNEL 1**, use **VOL+/-** to set the number which you want to swap, for example, channel 6.
- 3 Press **CH+/-** to select **CHANNEL 2**, use **VOL+/-** to set the number which you want to swap to, for example, channel 10.
- 4 Press **CH-** to select **EXCHANGE**, press **VOL+** or **VOL-** and the channel 6 and 10 are swapped. Repeat the above steps to edit the programs in your favourite order.

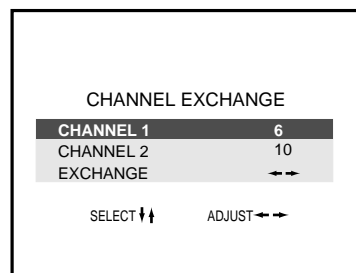

Picture adjustment

Picture adjustment

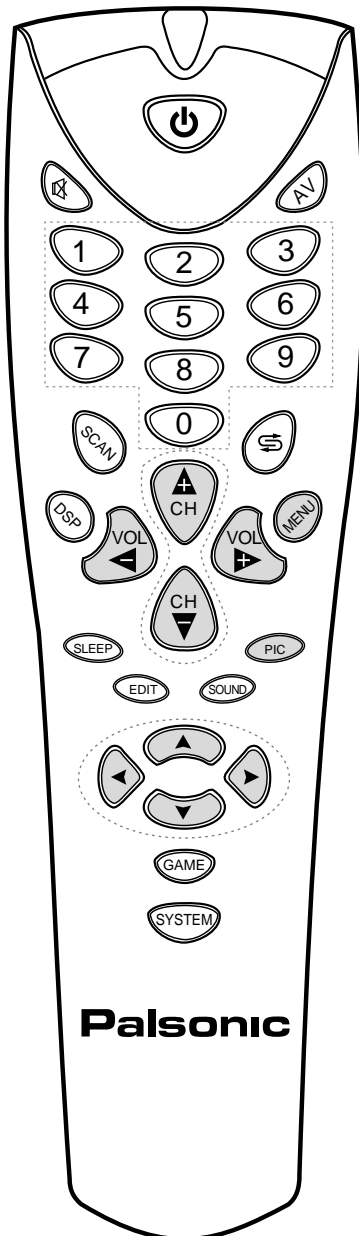

To select the picture mode

You can select the picture quality instantly among three modes and one user-set mode.

Press the **PIC** button to select the desired picture quality. **BRILLIANT**, **STANDARD**, **SOFTNESS** and **PERSONAL** (user-set) can be selected cyclically.

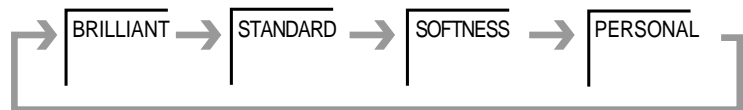

Mode	Picture quality
BRILLIANT	Display more brightness and contrast pictures
STANDARD	Display normal pictures
SOFTNESS	Display mild pictures
PERSONAL	The picture quality you set

Adjusting picture

- 1 Press **MENU** button.
- 2 Press **VOL+** or **VOL-** button to select **PICTURE** icon.
- 3 Press **CH-** to enter into the **PICTURE** menu.
- 4 In **PICTURE** menu, press **CH+/-** to select the desired item, press **VOL+/-** to adjust.

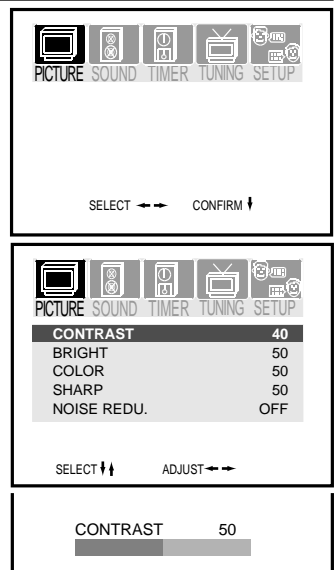

Item	VOL-	VOL+
Contrast	weaker	stronger
Brightness	darker	lighter
Colour	paler	deeper
Tint	purplish	greenish
Sharpness	softer	sharper
Noise reducer	ON/OFF	

Notes:

Tint is only for NTSC system.

The adjusted level is stored in the **PERSONAL** position.

Sound adjustment

Sound adjustment

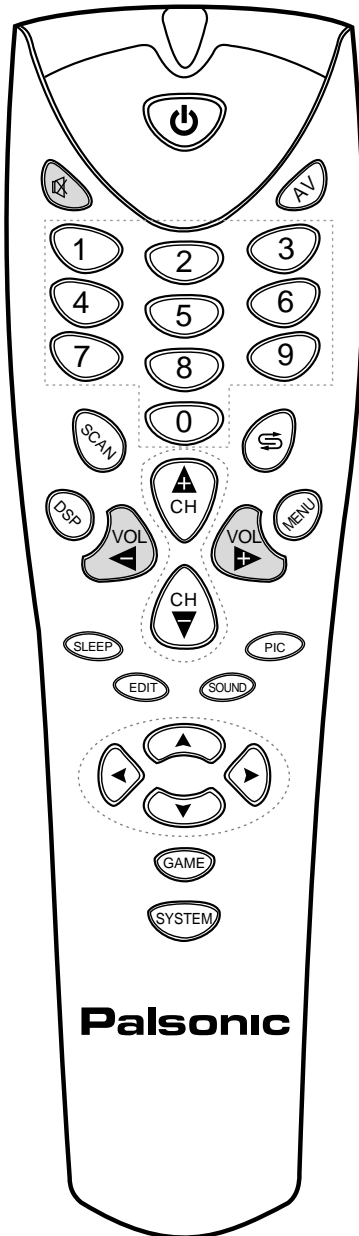

Adjusting volume

- 1 Use VOL+ or VOL- button.**
Press **VOL+** button, the volume increases;
Press **VOL-** button, the volume decreases.

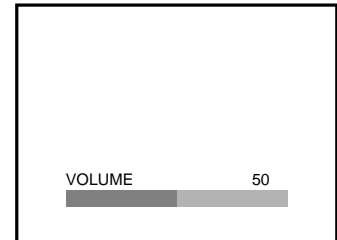

- 2 Use MUTE button.**
If you want to mute the sound, press **MUTE** button on the remote control.

To restore the sound, press this button again.

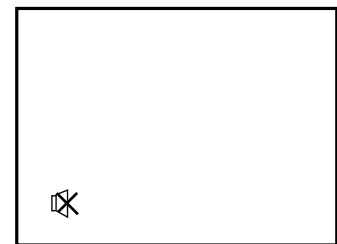

Notes:

You can also restore the sound by pressing **VOL+** or **VOL-** button.

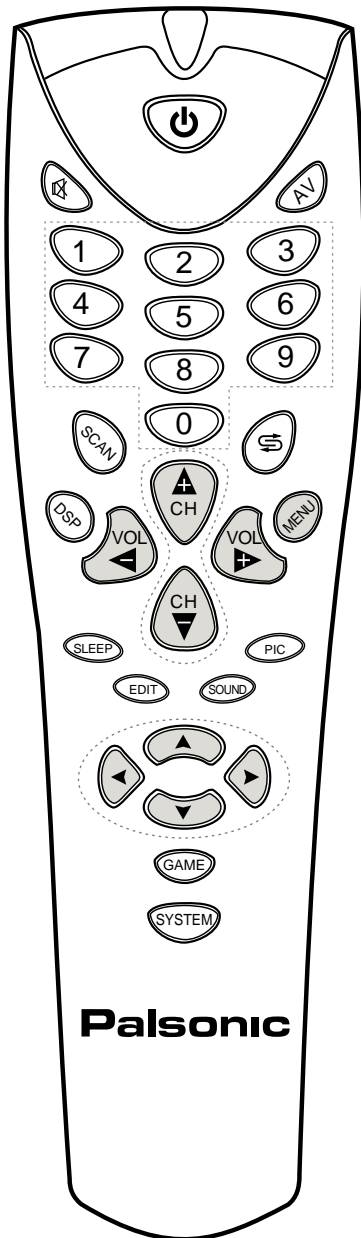

Adjusting sound

- 1** Press **MENU** button.
- 2** Press **VOL+** or **VOL-** button to select **SOUND** icon. Press **CH-** to enter into **SOUND** menu.
- 3** In **SOUND** menu press **CH+/-** to select desired item, press **VOL+/-** to adjust.

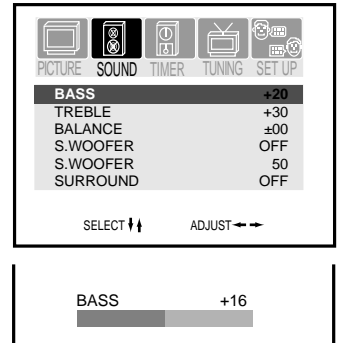

Item	VOL-	VOL+
BASS	Weaker	Stronger
TREBLE	Weaker	Stronger
BALANCE	Decrease the right channel	Decrease the left channel
S.WOOFER	ON/OFF	
S.WOOFER	Weaker	Stronger
SURROUND	OFF/HARD/SOFT/STEREO	

Note: if in the TV (RF) mode, Surround sound can be switched between OFF and Stereo. In VIDEO or DVD mode, Surround sound can be switched between OFF/SOFT/HARD.

Sound mode selection

You can select the sound quality instantly among three preset modes and one user-set mode.

Press the **SOUND** button to select the desired sound quality. **THEATRE**, **NEWS**, **MUSIC** and **PERSONAL** (user-set) can be selected cyclically.



Mode	Sound quality
THEATRE	Like a movie theatre filled with a dynamic sound.
NEWS	Suitable for listening to news/dialogue.
MUSIC	Like a music hall filled with a rich warm sound.
PERSONAL	The sound quality you set.

System setup

System setup

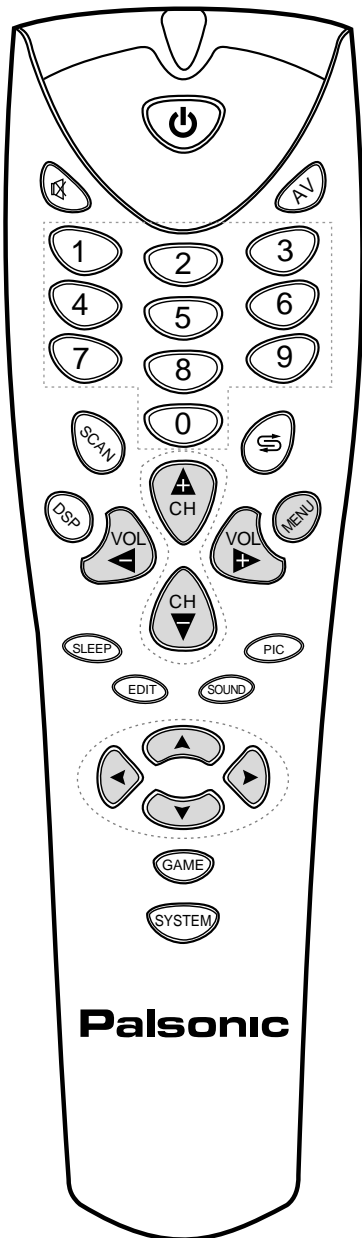

Selecting OSD language

- 1** Press **MENU** button.
- 2** Press **VOL+** or **VOL-** to select **SETUP** icon.
- 3** Press **CH-** to enter into **SETUP** menu.
- 4** Press **CH+/-** to select **LANGUAGE**.
- 5** Press **VOL+/-** to select English or Chinese (中文)

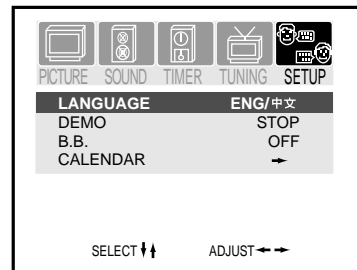
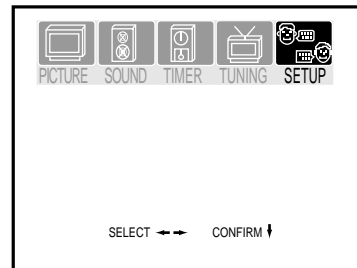

Menu demonstration

- 1** Enter into **SETUP** menu.
- 2** Press **CH+/-** to select **DEMO**.
- 3** Press **VOL+** or **VOL-** to select **START** and the TV starts the menu demonstration, which shows you how to use the menu.

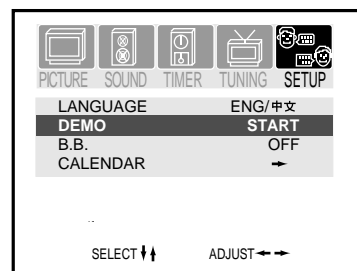

After the demonstration, it will return to **SETUP** menu and the **DEMO** item is auto set to **STOP**. After 4 seconds it exits the menu automatically.

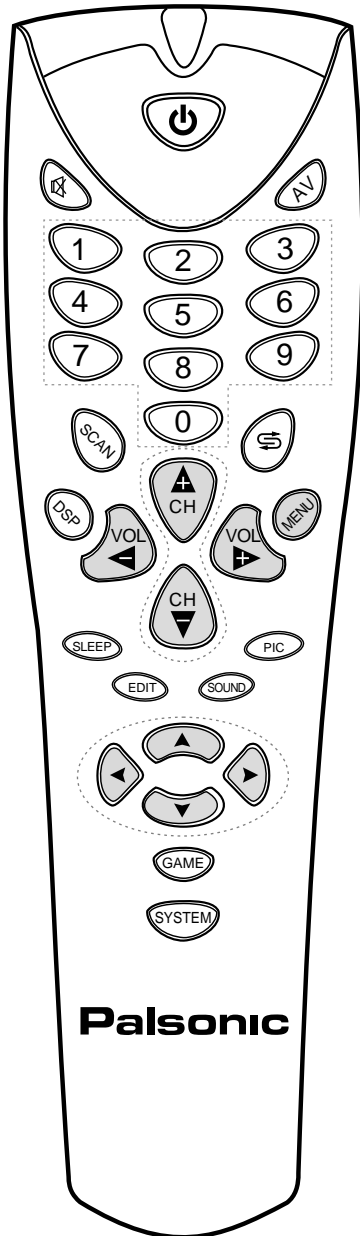

Setting Blue Background option

- 1** Enter into **SETUP** menu.
- 2** Press **CH+/-** to select **B.B.**
- 3** Press **VOL+/-** to select **On** or **Off**.

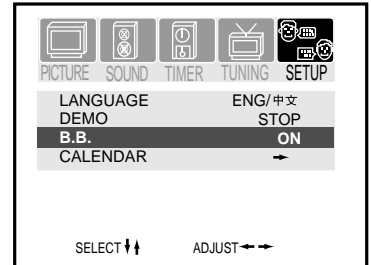

If the **B.B** is set to **On**, the TV set will display a blue background when there is no input signal.

If the **B.B** is set to **Off**, the TV will display snowy picture when there is no input signal.

Calendar

- 1** Enter into **SETUP** menu.
- 2** Press **CH+/-** to select **CALENDAR** item.
- 3** Press **VOL+/-** to enter into calendar sub-menu. Press **CH+/-** to select **SOLAR** or **LUNAR**, press **VOL+/-** to enter.
- 4** After entering into **SOLAR** or **LUNAR** calendar, press **CH+/-** to select year and press **VOL+/-** to select month.

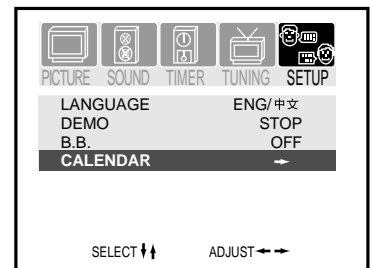
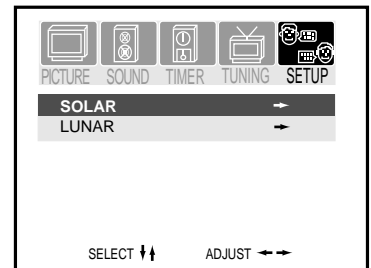

OCT 2008						
SU	MO	TU	WE	TH	FR	SA
			1	2	3	4
5	6	7	8	9	10	11
12	13	14	15	16	17	18
19	20	21	22	23	25	26
26	27	28	29	30	31	
YEAR ↑↓			MONTH ←→			

Timer setting

Clock/ON timer/OFF timer/Sleep timer

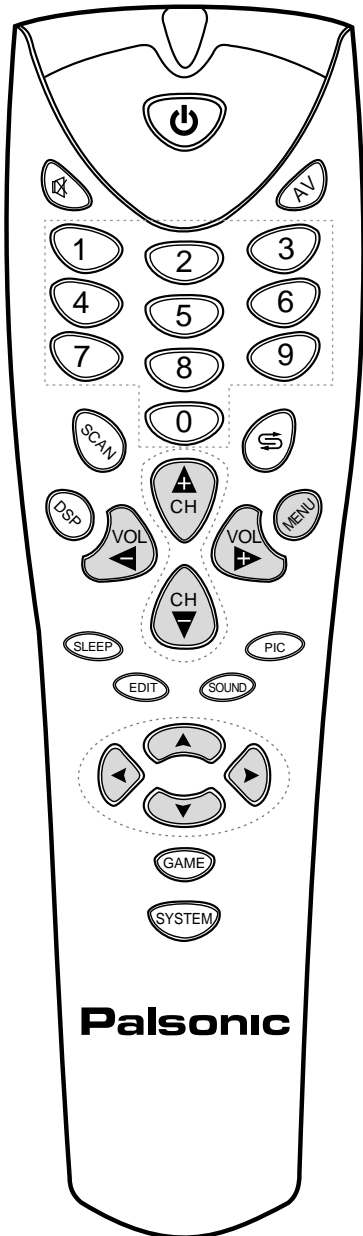

You can press DSP button twice to display the current time of the TV set, press again to cancel.

Setting clock

- 1 Enter into **TIMER** menu.
- 2 Press **CH-** to select **CLOCK**.
- 3 Press **VOL+** or **VOL-** to set the current time for the set.

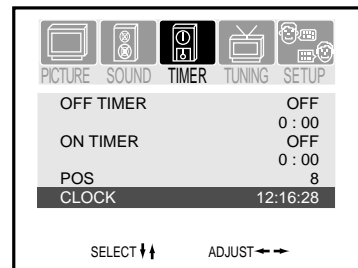

Note: Before setting the ON timer or OFF timer, please first set the clock.

Setting ON timer

With the ON timer, the TV will automatically turn on to a preset channel at a preset time.

- 1 In **TIMER** menu, press **CH+/-** to select **ON TIMER**.
- 2 Press **VOL+** or **VOL-** to select **ONCE** or **EVERY**.
If you set On Timer to **Once**, this function occurs once. If you set On Timer to **Every**, this occurs every day. To cancel this function, set On Timer to **Off**.
- 3 Press **CH-** button, use **VOL+/-** to set the **ON** time.
- 4 Press **CH-** button to select **POS** item, use **VOL+/-** to select a channel number.

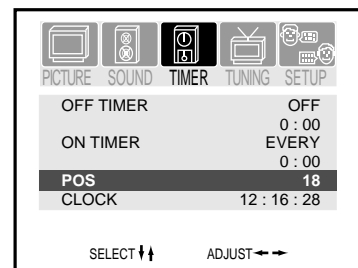
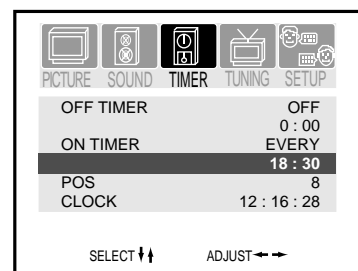
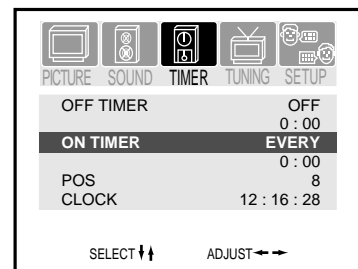

If the set is in standby mode, it will auto turn on and broadcast the preset channel at the preset time. If in normal working mode, the set will auto switch to the preset channel at the preset time.

Note: You must set ON TIMER to ONCE or EVERY prior to setting the time.

1 Press **MENU** button.

2 Press **VOL+/-** to select **TIMER** icon.

3 Press **CH-** to enter into **TIMER** menu.

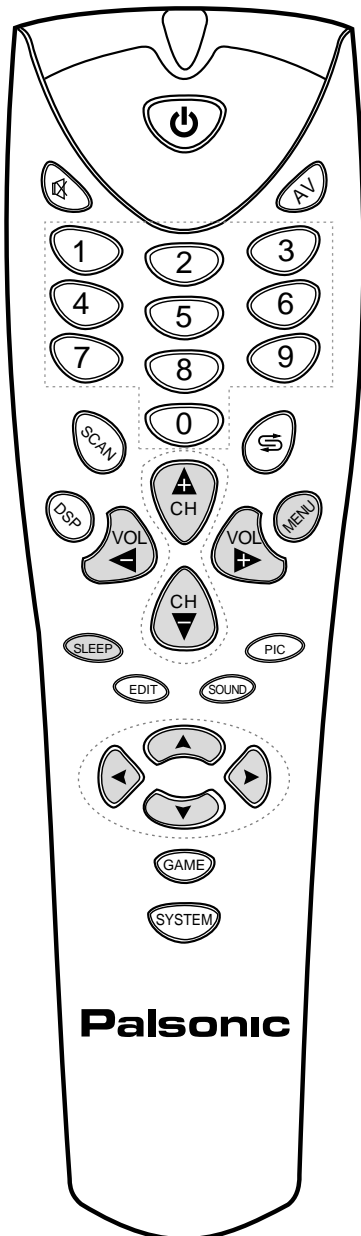
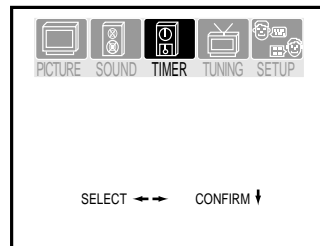

Setting OFF timer

With the OFF timer, the TV will automatically switch to standby mode at a preset time.

1 In **TIMER** menu, press **CH+/-** to select **OFF TIMER**.

2 Press **VOL+** or **VOL-** to select **ONCE** or **EVERY**.

If you set Off Timer to **Once**, this occurs only once; If you set Off Timer to **Every**, this occurs every day. TO cancel this function, set Off Timer to **Off**.

3 Press **CH-** button.

4 Press **VOL+** or **VOL-** to set the OFF time. The TV will turn off at the designated time.

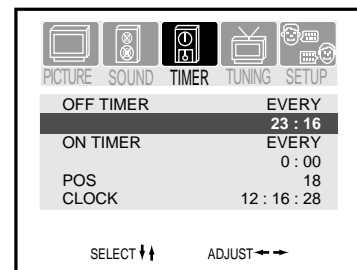
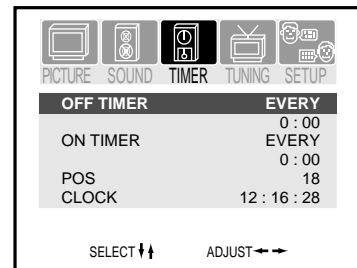

Note: to enable the OFF timer, you must first set Off Timer to Once or Every. When you are setting the time by **VOL+/-** button, if you press and hold, the time will increase or decrease by 10 minutes.

Setting Sleep timer

You can quickly set the sleep timer by using **SLEEP** button on the remote control. With every press of this button the sleep time changes in the sequence of OFF, 120 MIN., 110MIN., ---- 10MIN.

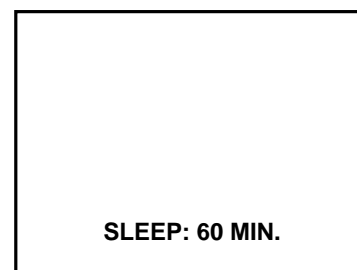

For example, you would like the TV to turn off in 60 minutes, you can press the **SLEEP** button repeatedly until the screen displays **60 MIN.**

To cancel the sleep timer, you can press the **SLEEP** button repeatedly until **OFF** is displayed on the screen.

Playing games

Playing games

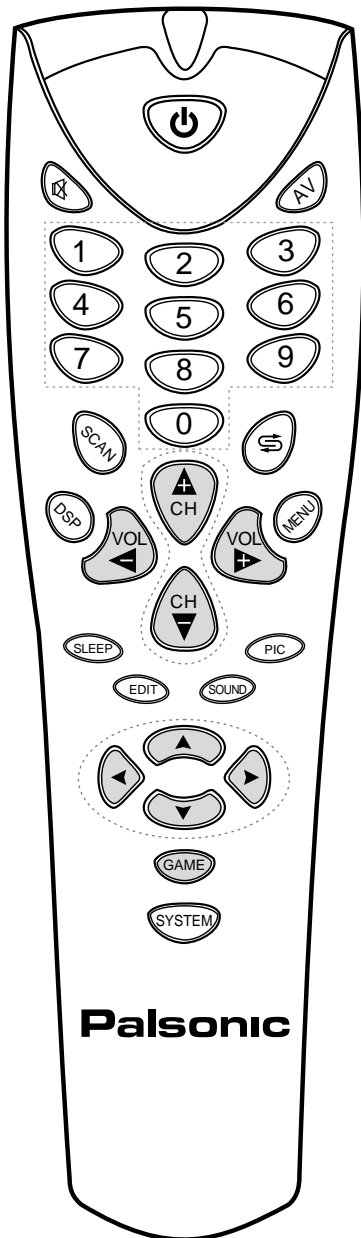

There are two built-in games for you to play: one is Falling cube, the other is Submarine.

Making use of Falling cube

- 1** Press **GAME** button once to enter into **Falling cube** game interface.
- 2** Press any one of **▲/▼/◀/▶** buttons to start the game.

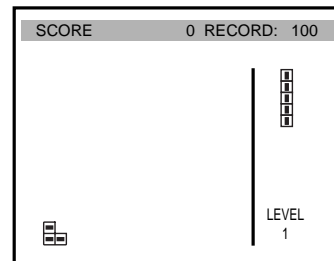

On the screen, there are falling cubes. Pressing **▲** button can change the cubes' shape; Pressing **◀** or **▶** buttons can move the cubes leftward or rightward while pressing **▼** button can hasten the cubes' falling speed.

When at the screen's left playing area one row has been filled with the cubes, the row will disappear, and your score will gain one point. If two rows disappear at the same time, your score will gain three points. If three rows disappear at the same time, your score will gain seven points.

The right window provides hints about next cubes' shape, you can arrange current cubes' position and angle in advance.

When the cubes reach to top, the screen will display **GAMEOVER**, and the game is over.

- 3** Press **GAME** button to exit.

Making use of Submarine

- 1** Press **GAME** button twice to enter into **Submarine** game interface.

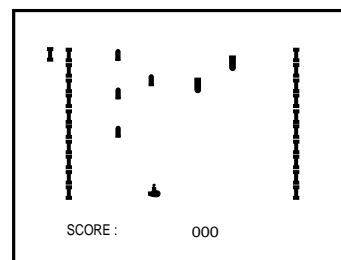

- 2** Press any one of **▲/▼/◀/▶** buttons to start the game.

On the screen there are torpedoes falling occasionally. You can control the yellow Submarine by **▲/▼/◀/▶**, buttons. Pressing **▲**, **▼**, **◀** or **▶** buttons can move the yellow Submarine upward, downward, leftward or rightward. Press **Channel down (CH-)** button to shoot cannonball. Every time you hit a torpedo or opponent submarine, you gain 100 points.

If the yellow submarine is hit by torpedo or opponent submarine, the game is over (**GAMEOVER**).

- 3** To restart the game, press **CH+** button.
- 4** Press **GAME** button to exit.

Troubleshooting Guide

Troubleshooting Guide

Before calling service personnel, please check the following chart for a possible cause to the trouble you are experiencing.

Symptoms	Check the following items
Power is not turned on	<ul style="list-style-type: none"> □ Be sure the power cord is plugged in.
Poor colour, poor tint	<ul style="list-style-type: none"> □ Contrast, colour, tint are not correctly adjusted
Spots appear on the screen	<ul style="list-style-type: none"> □ Possible interferences of automobiles, motorcycle, trolley bus, neon lamps, etc.
Stripes appear on the screen	<ul style="list-style-type: none"> □ Possible interference of electronic interference from another TV set, a computer, an electronics game machine, a broadcast station, etc.
Double images or "ghosts"	<ul style="list-style-type: none"> □ This may be caused by reflections from nearby mountains or buildings. □ Check the antenna direction.
Snowy picture	<ul style="list-style-type: none"> □ It is possible that the aerial "lead-in" is damaged or comes off. □ Check the antenna direction.
TV cabinet creaks	<ul style="list-style-type: none"> □ Even if the picture or the sound is normal, changes in room temperature sometimes makes the TV cabinet expand or contract, making a noise. This does not indicate a malfunction.
Remote controller does not work	<ul style="list-style-type: none"> □ The batteries may be worn out. □ The batteries may be installed with their polarity reversed.
Unevenness in colour in some parts of the screen	<ul style="list-style-type: none"> □ When the set is switched on, do not shift or move the set around. Sometimes it may develop an unevenness in colour in some parts of the screen. This can be eliminated by switching off the set with the POWER switch and wait for 10 minutes before switching on again.
The screen is black	<ul style="list-style-type: none"> □ Check whether the Child Lock is set to On.

Specifications

Specifications

Power Supply: ~240V, 50Hz
Power Consumption: 120W
Dimensions(mm): 684 (W) x 510 (H) x 526 (D)
Weight(kg): 35
CRT: 61cm

TV system & channel range

System	VHF	UHF	CATV
PAL-B/G	2-12	21-69	X~Z+2,S1~S41

Colour System: PAL-B/G NTSC (AV)
Sound output: 6W x 2
Accessories: Remote controller X 1

 Design and specifications are subject to change without notice.

PALSONIC CORPORATION PTY LTD
1 JOYNTON AVENUE
WATERLOO NSW 2017 AUSTRALIA
TEL: (02) 9313 7111
FAX: (02) 9313 7555
www.palsonic.com.au

**PALSONIC CUSTOMER SERVICE
TELEPHONE
AUSTRALIA: 1300 657 888**