

DVD Home Theatre System

Operating Instructions



MP3

*Digital Direct
Twin Drive Subwoofer*

DAV-SR4W

WARNING

To prevent fire or shock hazard, do not expose the unit to rain or moisture.

Do not install the appliance in a confined space, such as a bookcase or built-in cabinet.

To prevent fire, do not cover the ventilation of the apparatus with news papers, table-cloths, curtains, etc. And don't place lighted candles on the apparatus.

To prevent fire or shock hazard, do not place objects filled with liquids, such as vases, on the apparatus.



Don't throw away the battery with general house waste, dispose of it correctly as chemical waste.

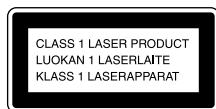

This appliance is classified as a CLASS 1 LASER product. The label is located on the bottom of the unit.

Precautions

Safety

- If anything falls into the cabinet, unplug the unit and have it checked by qualified personnel before operating it any further.
- The unit is not disconnected from the AC power source (mains) as long as it is connected to the wall outlet (mains), even if the unit itself has been turned off.
- Unplug the unit from the wall outlet if you do not intend to use it for an extended period of time. To disconnect the cord, pull it out by the plug, never by the cord.

Installing

- Allow adequate air circulation to prevent internal heat buildup.
- Do not place the unit on surfaces (rugs, blankets, etc.) or near materials (curtains, draperies) that may block the ventilation slots.
- Do not install the unit near heat sources such as radiators, or air ducts, or in a place subject to direct sunlight, excessive dust, mechanical vibration, or shock.
- Do not install the unit in an inclined position. It is designed to be operated in a horizontal position only.
- Keep the unit and discs away from equipment with strong magnets, such as microwave ovens, or large loudspeakers.
- Do not place heavy objects on the unit.

- If the unit is brought directly from a cold to a warm location, moisture may condense inside the DVD Home Theatre System and cause damage to the lenses. When you first install the unit, or when you move it from a cold to a warm location, wait for about 30 minutes before operating the unit.

Welcome!

Thank you for purchasing Sony DVD Home Theatre System. Before operating this system, please read this manual thoroughly and retain it for future reference.

Precautions

On power sources

AC power cord must be changed only at the qualified service shop.

On placement

- Place the system in a location with adequate ventilation to prevent heat build-up in the system.
- At high volume, over long periods of time, the cabinet becomes hot to the touch. This is not a malfunction. However, touching the cabinet should be avoided. Do not place the unit in a confined space where ventilation is poor as this may cause overheating.
- Do not block the cooling fan or ventilation slots by putting anything on the system. Also, do not place the system on a soft surface such as a rug that might block the ventilation holes on the bottom. The system is equipped with a high power amplifier. If the cooling fan or ventilation slots are blocked, the unit can overheat and malfunction.
- Do not place the system in a location near heat sources, or in a place subject to direct sunlight, excessive dust, or mechanical shock.

On operation

- If the system is brought directly from a cold to a warm location, or is placed in a very damp room, moisture may condense on the lenses inside the system. Should this occur, the system may not operate properly. In this case, remove the disc and leave the system turned on for about half an hour until the moisture evaporates.
- When you move the system, take out any disc. If you don't, the disc may be damaged.
- For power saving purposes, set the system to standby mode by pressing the  button (the STANDBY indicator lights up). To turn off the system completely, remove the AC power cord (mains lead) from the wall outlet (mains).

On adjusting volume

Do not turn up the volume while listening to a section with very low level inputs or no audio signals. If you do, the speakers may be damaged when a peak level section is suddenly played.

On cleaning

Clean the cabinet, panel, and controls with a soft cloth slightly moistened with a mild detergent solution. Do not use any type of abrasive pad, scouring powder or solvent such as alcohol or benzine.

If you have any questions or problems concerning your system, please consult your nearest Sony dealer.

On cleaning discs

Do not use a commercially available CD/DVD cleaning disc. It may cause a malfunction.

On your TV's color

If the speakers should cause the TV screen to have color irregularity, turn off the TV at once then turn it on after 15 to 30 minutes. If color irregularity should persist, place the speakers farther away from the set.

The nameplate is located on the bottom exterior of the unit.

IMPORTANT NOTICE

Caution: This system is capable of holding a still video image or on-screen display image on your television screen indefinitely. If you leave the still video image or on-screen display image displayed on your TV for an extended period of time you risk permanent damage to your television screen. Projection televisions are especially susceptible to this.

On moving the system

When you carry the system, use the following procedure to protect the inner mechanism.





- 1 Make sure that a disc is removed from the system.
- 2 Press FUNCTION repeatedly to select "DVD."
- 3 Press , , and  simultaneously. The front panel display is changed to "MECHA LOCK."
To cancel, press .
- 4 Remove the AC power cord (mains lead) from the wall outlet (mains).

Table of Contents

Welcome!	3
Precautions	3
About This Manual	6
This System Can Play the Following Discs	6
Terms for Discs	6
Notes about Discs	8
Guide to the Control Menu Display	9

Getting Started

Unpacking	11
Inserting Batteries into the Remote.....	11
Step 1: Speaker System Hookup.....	12
Step 2: Antenna (aerial) Hookups.....	19
Step 3: TV and Video Component Hookups.....	21
Step 4: Connecting the AC Power Cords (Mains Leads)	24
Step 5: Adjusting the Wireless System	25
Step 6: Performing the Quick Setup	30
Speaker Setup.....	32

Playing Discs

Playing Discs	33
Resuming Playback from the Point Where You Stopped the Disc	35 (Resume Play)
Using the DVD's Menu	36
Playing VIDEO CDs with PBC Functions (Ver. 2.0).....	36 (PBC Playback)
Playing an MP3 Audio Track	37
Playing JPEG Image Files	39
Creating Your Own Program.....	41 (Program Play)
Playing in Random Order	43 (Shuffle Play)
Playing Repeatedly	44 (Repeat Play)
Searching for a Particular Point on a Disc	45 (Scan, Slow-motion Play)
Searching for a Title/Chapter/Track/ Index/Album/File.....	46

Viewing Disc Information	48
--------------------------------	----

Sound Adjustments

Changing the Sound	52
Enjoying Surround Sound	54
Selecting the Surround Back Decoding Mode.....	58
Using the Sound Effect.....	60

Using Various Additional Functions

Changing the Angles	61
Displaying Subtitles.....	62
Locking Discs	63 (CUSTOM PARENTAL CONTROL, PARENTAL CONTROL)

Other Operations

Controlling TV with the Supplied Remote	68
Using the SONY TV DIRECT Function.....	70
Using the Video or Other Units.....	72
Enjoying Multiplex Broadcast Sound (DUAL MONO).....	72
Enjoying the Radio	73
Using the Radio Data System (RDS) ...	76
Using the Sleep Timer	77
Changing the Brightness of the Front Panel Display.....	77
Returning to the Default Settings	78

Settings and Adjustments







Using the Setup Display.....	79
Setting the Display or Sound Track	
Language	80
(LANGUAGE SETUP)	
Settings for the Display.....	80
(SCREEN SETUP)	
Custom Settings	82
(CUSTOM SETUP)	
Settings for the Speakers.....	83
(SPEAKER SETUP)	
Quick Setup and Resetting the System.....	88
(SETUP)	

Additional Information

Troubleshooting	89
Specifications	92
Glossary	94
Index to Parts and Controls.....	98
Language Code List	103
DVD Setup Menu List	104
AMP Menu List	106
Index	107
Quick Reference for Remote Commander	Back cover

About This Manual

- The instructions in this manual describe the controls on the remote. You can also use the controls on the system if they have the same or similar names as those on the remote.
- The following symbols are used in this manual.

Symbol	Meaning
	Functions available for DVD VIDEOS, DVD-Rs/DVD-RWs in video mode, and DVD+Rs/DVD+RWs
	Functions available in VIDEO CD mode
	Functions available in CD mode
	Functions available in Super Audio CD and Audio CD mode
	Functions available for MP3* audio tracks
	Functions available for JPEG files

* MP3 (MPEG1 Audio Layer 3) is a standard format defined by ISO/MPEG which compresses audio data.

This System Can Play the Following Discs

Format of discs	Disc logo
DVD VIDEO	
Super Audio CD	 SUPER AUDIO CD
VIDEO CD	
Audio CD	

Format of discs	Disc logo
CD-R/CD-RW (audio data) (MP3 files) (JPEG files)	

The “DVD VIDEO” logo is a trademark.

Terms for Discs

- **Title**
The longest section of a picture or music feature on a DVD, movie, etc., in video software, or the entire album in audio software.
- **Chapter**
Section of a picture or a music piece that is smaller than titles. A title is composed of several chapters. Depending on the disc, no chapters may be recorded.
- **Album**
Section of a music piece or an image on a data CD containing MP3 audio tracks or JPEG files.
- **Track**
Section of a picture or a music piece on a VIDEO CD, Super Audio CD, CD, or MP3.
- **Index (Super Audio CD, CD) / Video Index (VIDEO CD)**
A number that divides a track into sections to easily locate the point you want on a VIDEO CD, Super Audio CD, or CD. Depending on the disc, no indexes may be recorded.
- **Scene**
On a VIDEO CD with PBC functions (page 36), the menu screens, moving pictures and still pictures are divided into sections called “scenes.”
- **File**
Section of a picture on a data CD containing JPEG image files.

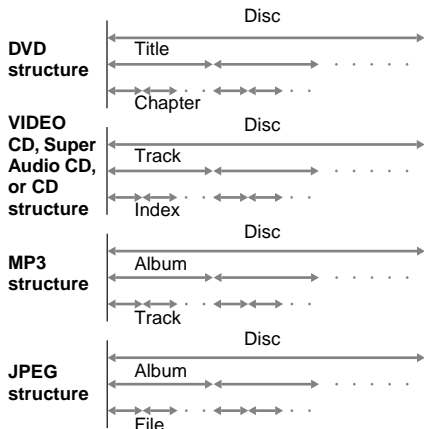

Note on PBC (Playback Control) (VIDEO CDs)

This system conforms to Ver. 1.1 and Ver. 2.0 of VIDEO CD standards. You can enjoy two kinds of playback depending on the disc type.

Disc type	You can
VIDEO CDs without PBC functions (Ver. 1.1 discs)	Enjoy video playback (moving pictures) as well as music.
VIDEO CDs with PBC functions (Ver. 2.0 discs)	Play interactive software using menu screens displayed on the TV screen (PBC Playback), in addition to the video playback functions of Ver. 1.1 discs. Moreover, you can play high-resolution still pictures, if they are included on the disc.

About Multi Session CD

- This system can play Multi Session CDs when an MP3 audio track is contained in the first session. Any subsequent MP3 audio tracks recorded in later sessions can also be played back.
- This system can play Multi Session CDs when a JPEG image file is contained in the first session. Any subsequent JPEG image files recorded in later sessions can also be played back.
- If audio tracks and images in music CD format or video CD format are recorded in the first session, only the first session will be played back.

Region code

Your system has a region code printed on the back of the unit and will only play DVDs labeled with the same region code.

DVDs labeled  will also play on this system. If you try to play any other DVD, the message [Playback prohibited by area limitations.] will appear on the TV screen. Depending on the DVD, no region code indication may be given even though playing the DVD is prohibited by area restrictions.

Examples of discs that the system cannot play

The system cannot play the following discs:

- CD-ROMs (except for extension “.MP3,” “.JPG,” or “.JPEG”)
 - CD-Rs/CD-RWs other than those recorded in the following formats:
 - audio CD format
 - video CD format
 - MP3/JPEG format that conforms to ISO9660* Level 1/Level 2, or its extended format, Joliet
 - Data part of CD-Extras
 - DVD-ROMs
 - DVD Audio discs
 - DVD-RAMs
 - DVD-RWs in VR (Video Recording) mode
 - Progressive JPEG file
- * A logical format of files and folders on CD-ROMs, defined by ISO (International Organization for standardization)

Do not load the following discs:

- A DVD with a different region code (page 7, 96).
- A disc that is neither standard nor circular (e.g., card, heart, or star shape).
- A disc with paper or stickers on it.
- A disc that has adhesive or cellophane tape still left on it.

Notes about CD-R/CD-RW/DVD-R/DVD-RW (Video mode)/DVD+R/DVD+RW

In some cases, CD-R/CD-RW/DVD-R/DVD-RW (Video mode)/DVD+R/DVD+RW cannot be played on this player due to the recording quality or physical condition of the disc, or the characteristics of the recording device and authoring software.

The disc will not play if it has not been correctly finalized. For more information, see the operating instructions for the recording device.

Note that discs created in the Packet Write format cannot be played.

Music discs encoded with copyright protection technologies

This product is designed to play back discs that conform to the Compact Disc (CD) standard.

Recently, various music discs encoded with copyright protection technologies are marketed by some record companies. Please be aware that among those discs, there are some that do not conform to the CD standard and may not be playable by this product.

Note on playback operations of DVDs and VIDEO CDs

Some playback operations of DVDs and VIDEO CDs may be intentionally set by software producers. Since this system plays DVDs and VIDEO CDs according to the disc contents the software producers designed, some playback features may not be available. Also, refer to the instructions supplied with the DVDs or VIDEO CDs.

Copyrights

This product incorporates copyright protection technology that is protected by U.S. patents and other intellectual property rights. Use of this copyright protection technology must be authorized by Macrovision, and is intended for home and other limited viewing uses only unless otherwise authorized by Macrovision. Reverse engineering or disassembly is prohibited.

This system incorporates with Dolby* Digital and Dolby Pro Logic (II) adaptive matrix surround decoder and the DTS** Digital Surround System.

- * Manufactured under license from Dolby Laboratories.
“Dolby”, “Pro Logic”, and the double-D symbol are trademarks of Dolby Laboratories.
- ** Manufactured under license from Digital Theater Systems, Inc.
“DTS”, “DTS-ES”, “Neo:6”, and “DTS Digital Surround” are trademarks of Digital Theater Systems, Inc.

Notes about Discs

On handling discs

- To keep the disc clean, handle the disc by its edge. Do not touch the surface.
- Do not stick paper or tape on the disc.



- Do not expose the disc to direct sunlight or heat sources such as hot air ducts, or leave it in a car parked in direct sunlight as the temperature may rise considerably inside the car.
- After playing, store the disc in its case.

On cleaning

- Before playing, clean the disc with a cleaning cloth.
Wipe the disc from the center out.



- Do not use solvents such as benzine, thinner, commercially available cleaners, or anti-static spray intended for vinyl LPs.

This system can only play back a standard circular disc. Using neither standard nor circular discs (e.g., card, heart, or star shape) may cause a malfunction.







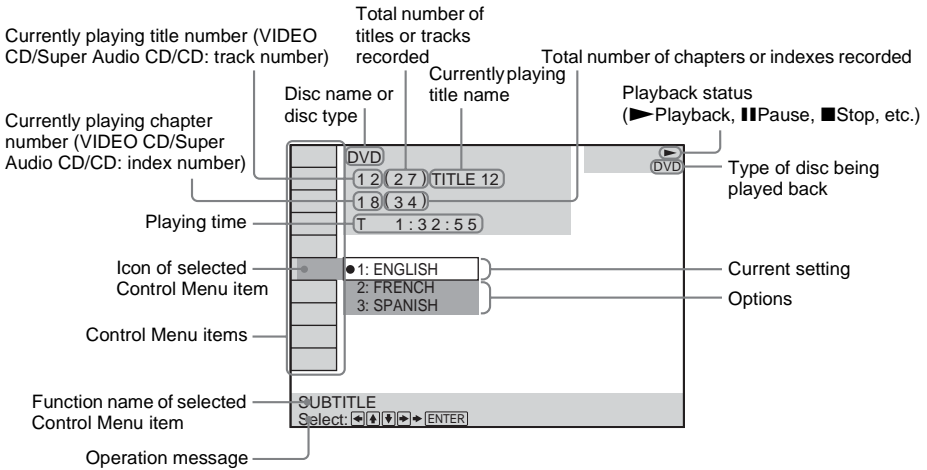



Do not use a disc that has a commercially available accessory attached, such as a label or ring.

Guide to the Control Menu Display







Use the Control Menu to select a function that you would like to use. The Control Menu display appears when the DVD DISPLAY button is pressed. For details, refer to the page in parentheses.



List of Control Menu Items

	DISC	Displays the disc name or the disc type inserted into the system.
	TITLE (DVD only) (page 46)/ SCENE (only VIDEO CD in PBC playback) / TRACK (VIDEO CD only) (page 46)	Selects the title (DVD), or the track (VIDEO CD) to be played. Displays the scene (VIDEO CD in PBC playback).
	CHAPTER (DVD only) (page 47)/ INDEX (VIDEO CD only) (page 47)	Selects the chapter (DVD) or the index (VIDEO CD) to be played.
	ALBUM (MP3 only) (page 38, 46)	Selects the album (MP3) to be played.
	TRACK (Super Audio CD/CD/ MP3 only) (page 38, 46)	Selects the track (Super Audio CD/CD/MP3) to be played.
	INDEX (Super Audio CD/CD only) (page 47)	Displays the index and selects the index (Super Audio CD) to be played.
	TIME (page 47)	Checks the elapsed time and the remaining playback time. Inputs the time code for picture and music searching.
	AUDIO (DVD/VIDEO CD/Super Audio CD/CD/MP3 only) (page 52)	Changes the audio setting.
	SUBTITLE (DVD only) (page 62)	Displays the subtitles. Changes the subtitle language.
	ALBUM (JPEG only) (page 39)	Selects the album (JPEG) to be played.

continued

	FILE (JPEG only) (page 39)	Selects the file (JPEG) to be played.
	DATE (JPEG only) (page 51)	Displays the date information.
	ANGLE (DVD only) (page 61)	Changes the angle.
	PLAYMODE (VIDEO CD/Super Audio CD/CD/MP3/JPEG only) (page 43)	Selects the play mode.
	REPEAT (page 44)	Plays the entire disc (all titles/all tracks), one title/chapter/track/album, or contents of program repeatedly.
	CUSTOM PARENTAL CONTROL (page 63)	Sets the disc to prohibit playing.

Tips

- Each time you press DVD DISPLAY, the Control Menu display changes as follows:

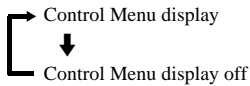

The Control Menu items vary, depending on the disc.

- The Control Menu icon indicator lights up in green  →  unless you set the [REPEAT] setting to [OFF].
- The [ANGLE] indicator lights up in green only when multiple angles are recorded on the disc.

Check that you have the following items:

- Speakers (5)
- Subwoofer (1)
- IR transmitter^{a)} (1)
- IR receiver^{a)b)} (1)
- IR receiver stand^{b)} (1)
- AM loop antenna (aerial) (1)
- FM wire antenna (aerial) (1)
- Speaker cords (3.5m × 3, 10m × 1)
- Remote Commander (remote) RM-SP320 (1)
- Size AAA (R03) batteries (2)
- Operating Instructions
- Speakers - Connection and Installation (card) (1)

^{a)} The cords of the IR transmitter and IR receiver are for this system only. You cannot use a commercially available extension cord.

^{b)} Used when the IR receiver of the surround speaker (L) cannot receive infrared ray because of the position. For details, see “Using the IR receiver” (page 27).

Inserting Batteries into the Remote

You can control the system using the supplied remote. Insert two size AAA (R03) batteries by matching the ⊕ and ⊖ ends on the batteries to the markings inside the compartment. When using the remote, point it at the remote sensor  on the system.

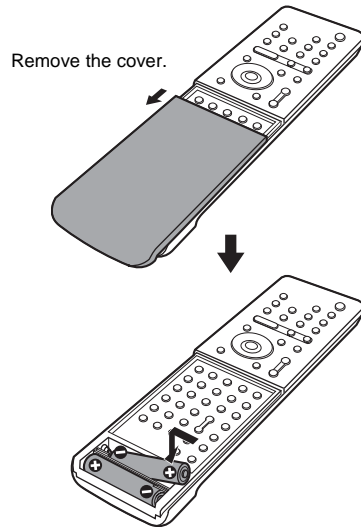

Notes

- Do not leave the remote in an extremely hot or humid place.
- Do not use a new battery with an old one.
- Do not drop any foreign object into the remote casing, particularly when replacing the batteries.
- Do not expose the remote sensor to direct light from the sun or lighting apparatus. Doing so may cause a malfunction.
- If you do not use the remote for an extended period of time, remove the batteries to avoid possible damage from battery leakage and corrosion.

Step 1: Speaker System Hookup

Connect the supplied speaker system using the supplied speaker cords by matching the colors of the jacks to those of the cords. Do not connect any speakers other than those supplied with this system. To obtain the best possible surround sound, specify the speaker parameters (distance, level, etc.) on page 32.

Required cords

Speaker cords

The connector and the color tube of the speaker cords are the same color as the label of the jacks to be connected.

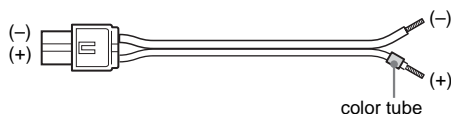

Required equipments for the wireless system

IR transmitter

Transmits the sound by the infrared ray. Connect it to the system.

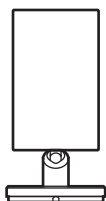

Surround speaker (L)

The surround speaker (L) incorporates the IR receiver. It receives the sound from the IR transmitter and sends it to the surround speaker (R).

Connect the surround speaker (R).

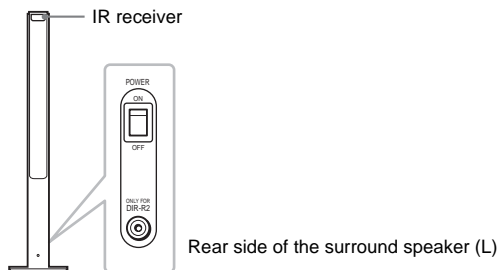

IR receiver

Used when the IR receiver of the surround speaker cannot receive infrared ray because of the position. Connect to the surround speaker (L). For details, see “Using the IR receiver” (page 27).



When using the IR receiver stand, attach the stand so that both delta marks on the IR receiver and stand are aligned.

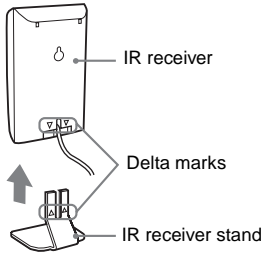

Note

When you connect the IR receiver to the surround speaker (L), the IR receiver is activated and the IR receiver of the surround speaker (L) is not activated automatically.

Terminals for connecting the speakers

Connect the	To the
Front speakers	SPEAKER FRONT L (white) and R (red) jacks of the system
Center speaker	SPEAKER CENTER (green) jack of the system
Subwoofer	SPEAKER WOOFER (purple) jacks of the system
Surround speaker (R)	SPEAKER (gray) jack of the surround speaker (L)
IR transmitter	DIR-T1 (pink) jack of the system

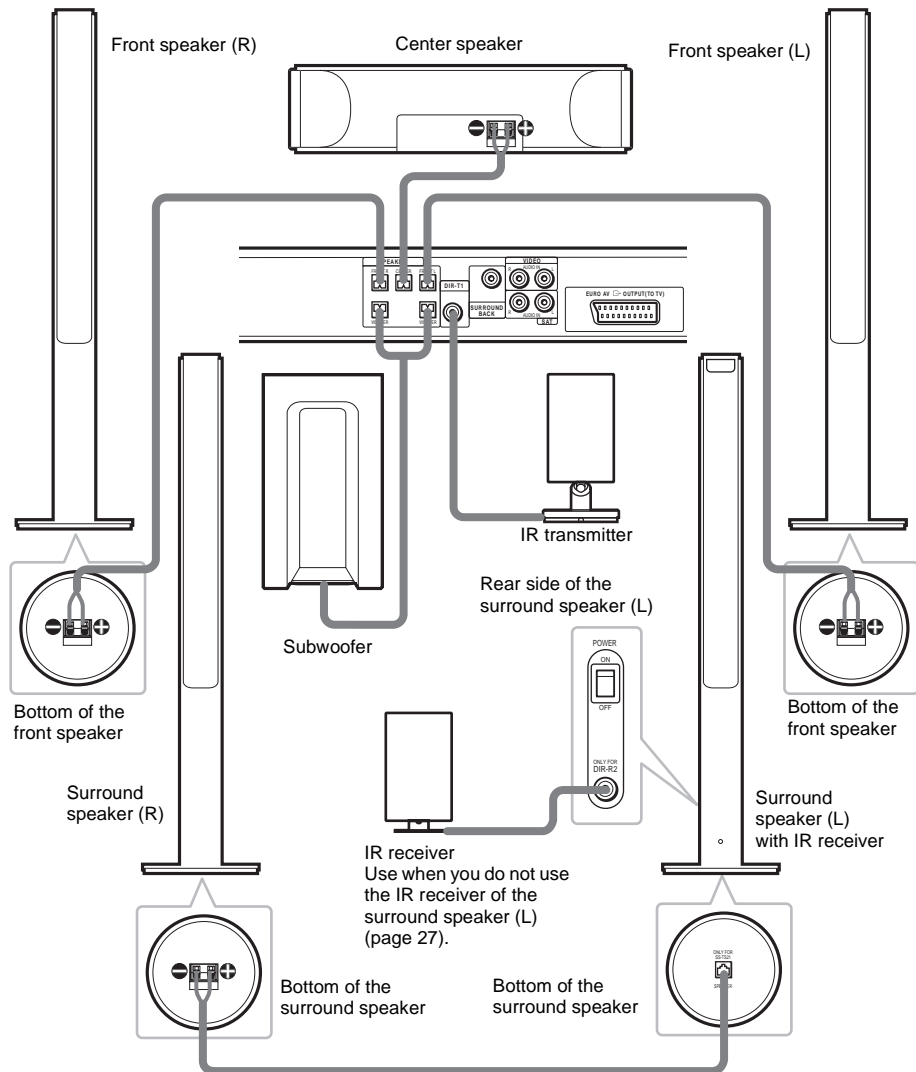

Note on placing speakers

- Do not set the speakers in an inclined position.
- Do not place the speakers in locations that are:
 - Extremely hot or cold
 - Dusty or dirty
 - Very humid
 - Subject to vibrations
 - Subject to direct sunlight
- Use caution when placing the subwoofer or tall speakers on a specially treated (waxed, oiled, polished, etc.) floor, as staining or discoloration may result.
- Do not lean or hang on the speaker, as the speaker may fall down.



Notes on placing IR transmitter and surround speaker (L) (or IR receiver)

- Do not install the surround speaker (L) (or IR receiver) in a place exposed to direct sunlight or strong light such as an incandescent lamp.
- The cords of the IR transmitter and IR receiver are for this system only. You cannot use a commercially available extension cord.

Tip for the surround speaker (L)

You can swap the surround speaker (L) and (R) positions, depending on the wall outlet and speaker layout (page 24).

Note

Do not catch the speaker cable insulation in the SPEAKER jack.

Tip

Connect the speaker cable after bending the speaker wire at the end of the insulation. This prevents the speaker cable from being caught in the SPEAKER jack.

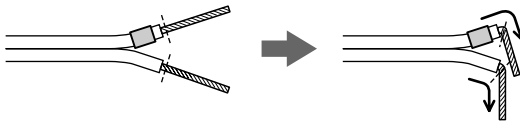

To connect the surround back speaker

This system is compatible with the 6.1 surround system. When you enjoy a DVD that is compatible with the 6.1 surround system such as a DTS-ES disc, connect the surround back speaker (not supplied) and set its parameters (see “Settings for the Speakers” on page 83).

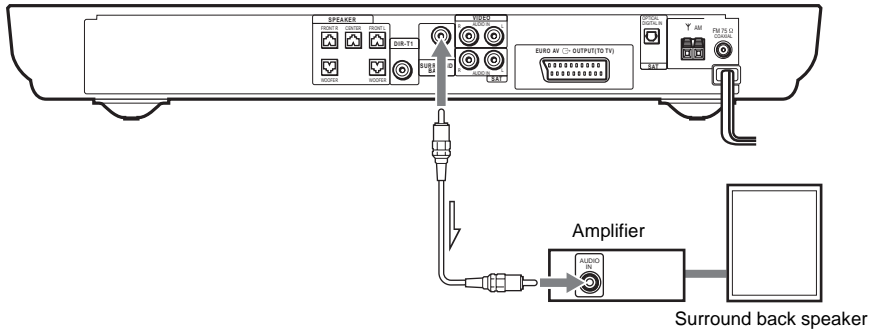

Tip

You can also enjoy the 6.1 surround sound when you play a 2 or 5.1 channel source by using the surround back decoding function (see “Selecting the Surround Back Decoding Mode” on page 58).

To avoid short-circuiting the speakers

Short-circuiting of the speakers may damage the system. To prevent this, be sure to follow these precautions when connecting the speakers. Make sure the bare wire of each speaker cord does not touch another speaker jack or the bare wire of another speaker cord.

Examples of poor conditions of the speaker cord

Stripped speaker cord is touching another speaker terminal.

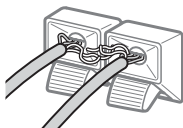

Stripped cords are touching each other due to excessive removal of insulation.

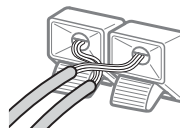

After connecting all the components, speakers, and AC power cord (mains lead), output a test tone to check that all the speakers are connected correctly. For details on outputting a test tone, see page 85. If no sound is heard from a speaker while outputting a test tone, or a test tone is output from a speaker other than the one currently displayed in the front panel display, the speaker may be short-circuited. If this happens, check the speaker connection again.

Notes

- Be sure to match the speaker cord to the appropriate terminal on the components: \oplus to \oplus , and \ominus to \ominus . If the cords are reversed, the sound will lack bass and may be distorted.
- If you connect the speaker cord incorrectly or turn up the volume in a state of a short circuit, “PROTECT” appears in the front panel display and the system enters standby mode. In this case, disconnect and then reconnect the AC power cord (mains lead) from the wall outlet (mains), and then turn the system on.

To change the speaker cables

If you want to use a different speaker cable, you can detach the plug for attachment to another cable.

Detaching

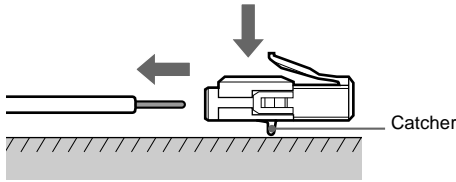

With the catcher facing down, press and hold the plug down against a flat surface and remove the cords from plug.

Attaching

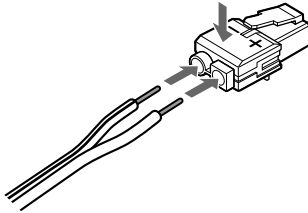

While pressing the plug down against a flat surface, insert the new speaker cords.

Note that the cord marked with a line should be attached to the minus (-) side of the plug.

Notes

- Be careful not to damage the surface you use (desk, etc.) when attaching/detaching the speaker cords.
- When using the subwoofer cord, note that the two outside black cords or the cords marked with letters are negative.

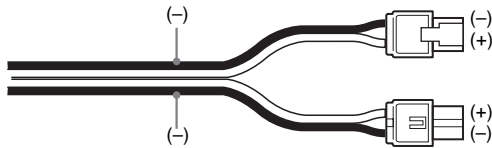

- If you connect the subwoofer cord incorrectly or turn up the volume in a state of a short circuit, "PROTECT" appears in the front panel display and the system enters standby mode. In this case, disconnect and then reconnect the AC power cord (mains lead) from the wall outlet (mains), and then turn the system on.

Tips

- You can use any commercially sold speaker cable of gauge cord AWG #18 - AWG #22.
- Before attaching a new cable, strip off 10 mm (13/32 in.) of its insulation and twist the bare wires of both cords.

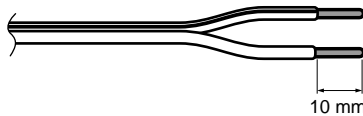

About the wireless system

This wireless system adopts the Digital Infrared Audio Transmission system (page 94). The following diagram indicates the infrared transmission area (the range that the infrared rays can reach).

When using the IR receiver of the surround speaker (L)

Top view

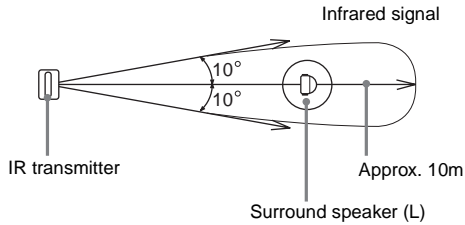

Side view

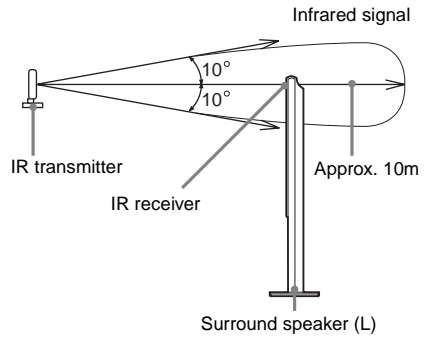

When using the IR receiver

Top view

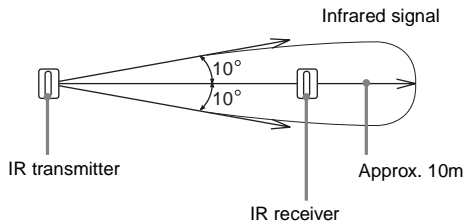

Side view

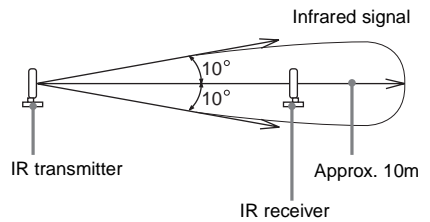

Notes

- Do not install the surround speaker (L) (or IR receiver) in a place exposed to direct sunlight or strong light such as an incandescent lamp.
- Do not use the surround speaker (L) (or IR receiver) that is not supplied with the system.

Step 2: Antenna (aerial) Hookups

Connect the supplied AM/FM antennas (aerials) for listening to the radio.

Terminals for connecting the antennas (aerials)

Connect the	To the
AM loop antenna (aerial)	AM terminals
FM wire antenna (aerial)	FM 75Ω COAXIAL jack

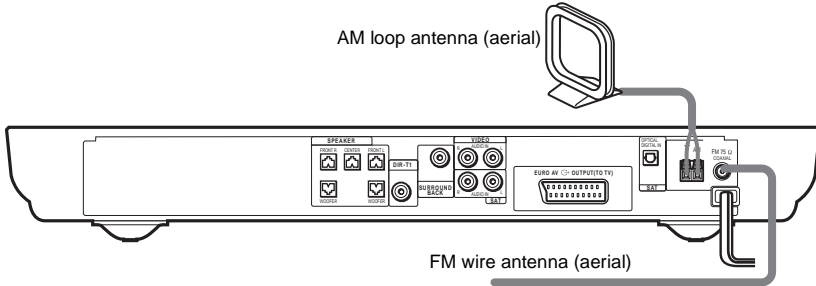

Notes

- To prevent noise pickup, keep the AM loop antenna (aerial) away from the system and other components.
- Be sure to fully extend the FM wire antenna (aerial).
- After connecting the FM wire antenna (aerial), keep it as horizontal as possible.

Tip

When you connect the supplied AM loop antenna (aerial), the cord (A) and the cord (B) can be connected in either terminal.

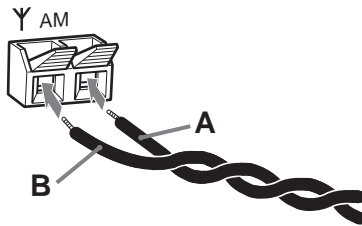

Tip

If you have poor FM reception, use a 75-ohms coaxial cable (not supplied) to connect the system to an outdoor FM antenna (aerial) as shown below.

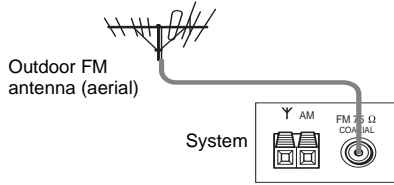

Step 3: TV and Video Component Hookups

Required cords

SCART (EURO AV) cord for connecting a TV (not supplied)



Audio cords (not supplied)

When connecting a cord, be sure to match the color-coded sleeves to the appropriate jacks on the components.

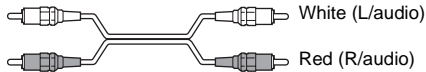

Terminals for connecting video components

Connect the	To the
TV (VIDEO IN)	➞ EURO AV OUTPUT (TO TV) jack
VCR (AUDIO OUT)	VIDEO (AUDIO IN) jacks
Digital satellite receiver (AUDIO OUT)	SAT (AUDIO IN) jacks

Connecting the system to a TV

Connect the system to your TV using the SCART (EURO AV) cord. Be sure to connect the SCART (EURO AV) cord to the ➞ EURO AV OUTPUT (TO TV) jack on the system.

When you connect using the SCART (EURO AV) cord, check that the TV conforms to S video or RGB signals. If the TV conforms to S video, change the input mode of the TV to RGB signals. Refer to the operating instructions supplied with the TV to be connected.

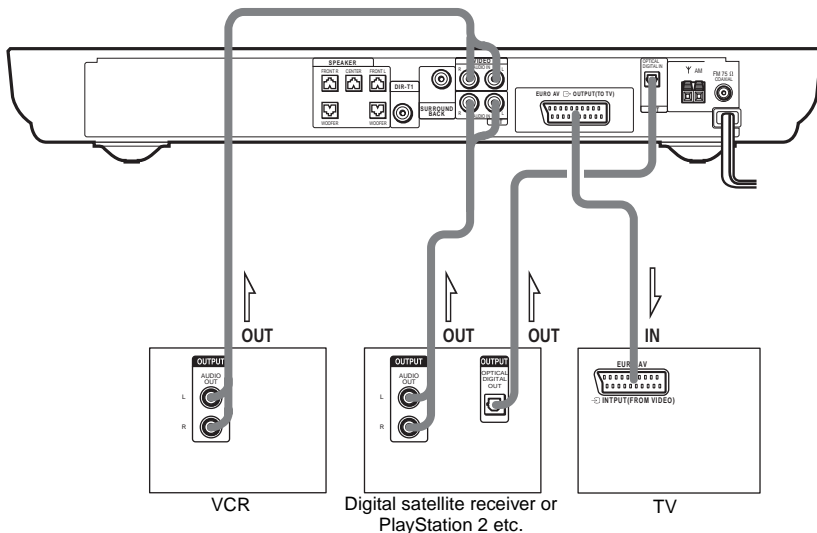

Notes

- Make connections securely to prevent unwanted noise.
- Refer to the instructions supplied with the TV.
- The system cannot output component video signals.
- The system cannot output an audio signal to the connected TV. Only the audio signal of the TV is output from the system speakers.

Tips

- When you want to output the TV sound or stereo sound of a 2 channel source from the 6 speakers, select any sound field other than “AUTO FORMAT DIRECT AUTO” or “2CH STEREO” (page 54).
- If a distortion occurs during playback of the component that is connected to the VIDEO AUDIO IN jacks, connect the component to the SAT AUDIO IN jacks.

If you connect a digital satellite receiver with an OPTICAL OUT jack

The digital satellite receiver can be connected to the SAT OPTICAL DIGITAL IN jack instead of the SAT AUDIO IN (L/R) jacks of the system.

The system can accept both the digital and analogue signals. Digital signals have priority over analogue signals. If the digital signal ceases, the analogue signal will be processed after 2 seconds.

If you connect a digital satellite receiver without an OPTICAL OUT jack

Connect the digital satellite receiver to the SAT AUDIO IN (L/R) jacks only of the system.

To listen to the game machine (e.g., PlayStation 2) sound by using the system

Connect the audio output jacks of the game machine to the SAT AUDIO IN (L/R) jacks of the system with the audio cords (not supplied).

Notes

- The system does not output S video signals.
- When you select VIDEO or SAT by pressing FUNCTION (page 72), the audio signal from the AUDIO IN (L/R) jack is output to the connected speakers. The audio signal is not output from the EURO AV OUTPUT (TO TV) jack.

When connecting to a standard 4:3 screen TV

Depending on the disc, the image may not fit your TV screen.
If you want to change the aspect ratio, please refer to page 80.

Step 4: Connecting the AC Power Cords (Mains Leads)

Before connecting the AC power cords (mains leads) of this system and the surround speaker (L) to a wall outlet (mains), connect the front and center speakers to the system and surround speaker (R) to the surround speaker (L) (see page 14).

When placing the surround speaker (L) in the (R) position

Depending on the location of the wall outlet (mains), you can also place the surround speaker (L) (with the IR receiver) in the (R) position if necessary.

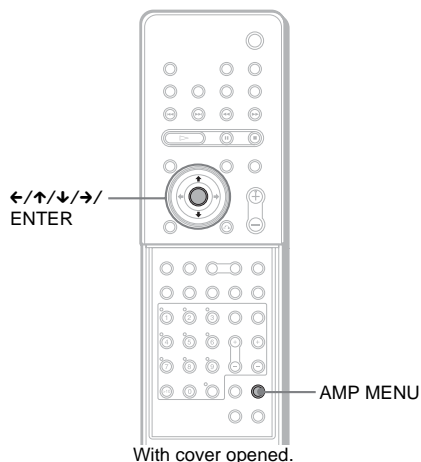

- 1 Press I/O on the system to turn the system on.**
- 2 Press AMP MENU.**
- 3 Press ↑/↓ repeatedly until “CUSTOMIZE” appears in the front panel display, then press ENTER or →.**
The system enters the Customize Menu mode.

4 Press ↑/↓ repeatedly until “SL SR REV” appears in the front panel display, then press ENTER or →.

5 Press ↑/↓ repeatedly until the item you want to set appears in the front panel display.

■OFF (default)

Sets the surround speaker (L) (with the IR receiver) in the (L) position.

■ON

Sets the surround speaker (L) (with the IR receiver) in the (R) position.

6 Press AMP MENU.

The AMP menu turns off.

Step 5: Adjusting the Wireless System

After connecting the speakers, IR transmitter, and the AC power cords (mains leads), adjust the wireless system for good transmission.

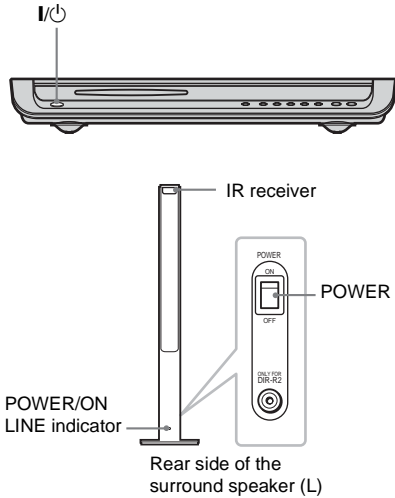

Tip

The IR transmitter is movable for easy reorientation.

Notes

- Make sure that there is no obstruction such as a person or object between the IR transmitter and the IR receiver of the surround speaker (L). Otherwise, the sound from the surround speakers may be interrupted.
- If the POWER/ON LINE indicator turns red, the transmission is incomplete. Adjust the position of the IR transmitter and surround speaker (L) until the POWER/ON LINE indicator turns green.
- If the POWER/ON LINE indicator flashes in red, the IR receiver of the surround speaker (L) is receiving an infrared ray from another Sony's wireless product. Move the IR transmitter and/or the surround speaker (L) so that the POWER/ON LINE indicator turns green.

1 Press I/O on the system and POWER on the surround speaker (L) to turn on.

The system and surround speaker (L) turn on and the POWER/ON LINE indicator turns red.

2 Orient the IR transmitter and the IR receiver of the surround speaker (L) to face each other.

Adjust the position until the POWER/ON LINE indicator turns green.

Example for installation

Position the IR transmitter and surround speaker (L) as illustrated.

Install the IR transmitter and IR receiver of the surround speaker (L) in direct line with each other, and adjust the orientation of the IR transmitter and surround speaker (L) until the POWER/ON LINE indicator turns green.

Top view

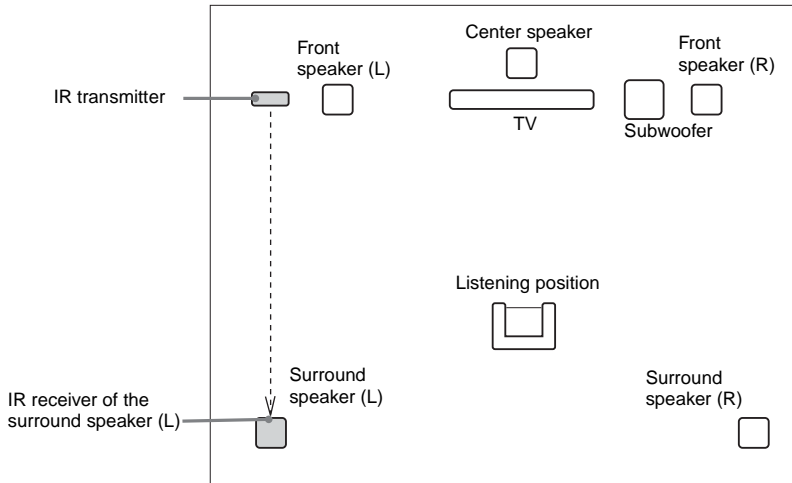

Using the IR receiver

Depending on the speaker layout (i.e. when placing the surround speaker (L) toward the listening position, etc.), or when there is obstruction, such as a person or object between the IR transmitter and the IR receiver of the surround speaker (L), you can use the external IR receiver (supplied) instead. The IR receiver is compact and easy to install.

To connect the IR receiver

Connect the cord of the IR receiver to the DIR-R2 jack of the surround speaker (L).

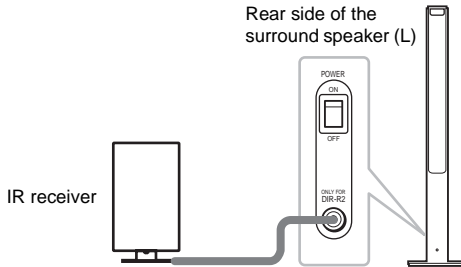

Notes

- When you connect the IR receiver to the surround speaker (L), the IR receiver is activated and the IR receiver of the surround speaker (L) is not activated automatically.
- When using the IR receiver, install it following the guidelines of the IR receiver of the surround speaker (L).

Hanging the IR transmitter and IR receiver on a wall

You can hang the IR transmitter and IR receiver on a wall when:

- there is an obstruction between the IR transmitter and the IR receiver.
- people often pass between the IR transmitter and the IR receiver.

When hanging both the IR transmitter and IR receiver, adjust the position of the IR transmitter after deciding the position of the IR receiver.

To hang the IR receiver on a wall

- 1 Install a commercially available screw in the wall so that it protrudes 4 mm.**

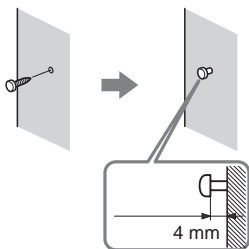

- 2 Detach the IR receiver stand and hang it via hole on the rear side of the IR receiver on the screw.**

Make sure that the IR receiver does not move after installation.

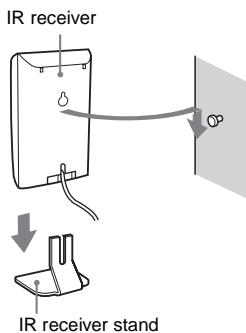

Tip

When reattaching the IR receiver stand to the IR receiver, attach the stand so that both delta marks on the IR receiver and stand are aligned (page 13).

To hang the IR transmitter on a wall

- 1 Rotate the stand of the IR transmitter.**

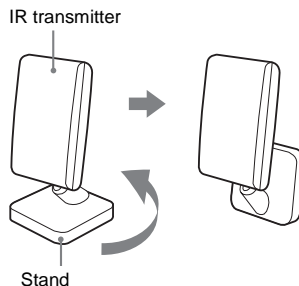

- 2 Install 2 commercially available screws in the wall so that it protrudes 4 mm.**

Install the screws 30 mm apart.

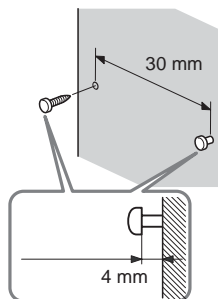

3 Hang the IR transmitter via hole on the bottom of the stand on the screw.

Make sure that the IR transmitter does not move after installation.

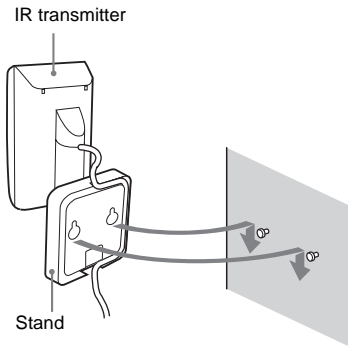

Tip

You can store the cords in the troughs in the bottom of the stand.

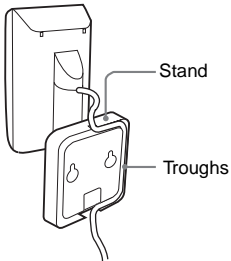

Notes

- Use screws suitable for the material and strength of the wall.
- Do not install the IR transmitter or IR receiver to a wall of low strength.
- Sony is not liable for any damage or accident incurred by incorrect installation (i.e. low strength wall, etc.), incorrect use of this product, or natural disaster.
- When connecting/disconnecting cords, detach the IR transmitter or IR receiver from the wall first.

Step 6: Performing the Quick Setup

After completing the first 4 steps, make initial settings using the Quick Setup. You can set the initial setting of [LANGUAGE SETUP], [ROOM SIZE], [LISTENING POSITION], and [TV TYPE] step by step.

After performing the Quick Setup, the system is ready for playing back of movies, music CDs, etc. To perform further speakers settings, see “Settings for the Speakers” on page 83.

How to use the Quick Setup

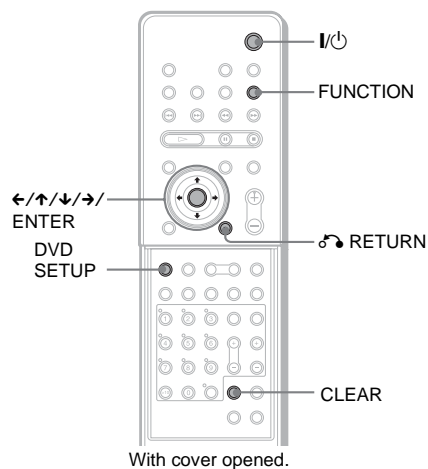

- 1 Turn on your TV.
- 2 Switch the input selector on the TV to this system.
- 3 Press I/ON.
- 4 Press FUNCTION to select “DVD.”

The guide message appears on the TV screen.

Note

When a disc is in the system, the guide message does not appear on the TV screen.

5 Press ENTER.

[LANGUAGE SETUP] appears.

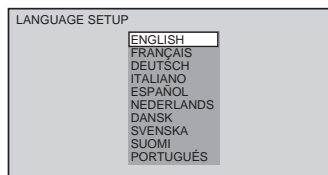

Notes

- The selectable language is different depending on the area.
- The language you select in [LANGUAGE SETUP] is also used for [OSD], [DVD MENU], and [SUBTITLE] (page 80).

6 Select a language using ↑/↓, then press ENTER.

Setting is selected and [ROOM SIZE] appears.

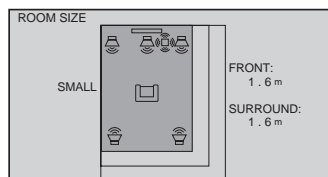

7 Select a suitable room size from [SMALL], [MEDIUM], or [LARGE] using \uparrow/\downarrow , then press ENTER.

Setting is selected and [LISTENING POSITION] appears.

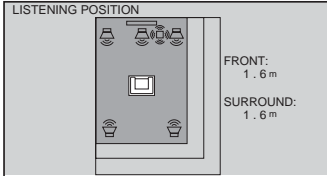

The [LISTENING POSITION] number you can select varies, depending on the [ROOM SIZE] setting.

[SMALL]: Three positions

[MEDIUM]: Four positions

[LARGE]: Five positions

8 Select a suitable listening position using \uparrow/\downarrow , then press ENTER.

Setting is selected and [TV TYPE] appears.

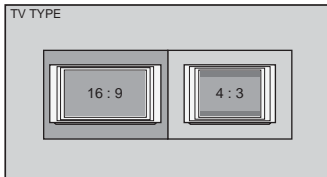

9 Select a TV type connecting to the system using \leftarrow/\rightarrow , then press ENTER.

The Quick Setup is complete.

When the Quick Setup is completed, the settings are saved and the guide message will not appear the next time you turn on the system.

If you make a mistake

Press \hookrightarrow RETURN, then select the item again.

To quit the Quick Setup

Press DVD SETUP in any Step.

Notes

- When you press CLEAR in guide message, the message disappears. When you need to change settings, select [QUICK] from [SETUP] in Setup Display (page 88).
- When you select [4:3] in [TV TYPE], [4:3 LETTER BOX] is selected (page 80).
- The distance and level of each speaker will be set automatically according to the selection of [ROOM SIZE] and [LISTENING POSITION] (page 83).
- If you want to change each setting, see “Using the Setup Display” on page 79.
- The illustrations displayed for [ROOM SIZE] and [LISTENING POSITION] are only examples and may differ from the actual room size and layout. The settings for [SPEAKER SETUP] (page 83) do not appear on these displays.

Speaker Setup

Positioning the speakers

For the best possible surround sound, all the speakers other than the subwoofer should be the same distance from the listening position (A). However, this system allows you to place the center speaker up to 1.6 meters closer (B) and the surround speakers up to 4.6 meters closer (C) to the listening position.

The front speakers can be placed from 1.0 to 7.0 meters (A) from the listening position.

Place speakers as illustrated below

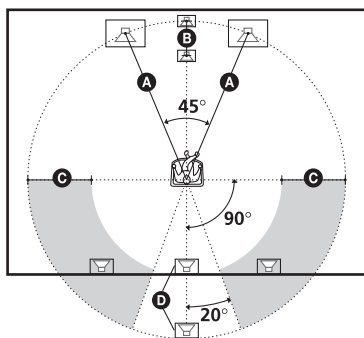

Notes

- Do not place the center and surround speakers farther away from the listening position than the front speakers.
- When you connect an optional surround back speaker, place the surround back speaker behind the listening position (place D) as illustrated above). In this case, set [SURROUND BACK] to [YES] in the [SIZE] setting (page 83) to output sound from the surround back speaker.

About magnetically shielded speakers (to prevent color irregularity occurring on the TV screen)

The subwoofer in this system is magnetically shielded to prevent magnetic leakage. However, some leakage may occur, as a high-strength magnet is employed. If the subwoofer is used with a CRT-based TV or projector, install the subwoofer at least 0.3 meter from the TV set. If it is installed too close, color irregularity may occur on the screen. If color irregularity occurs, turn off the TV set once, then turn it on after 15 to 30 minutes. If color irregularity occurs again, place the subwoofer farther away from the TV set. If color irregularity still occurs after performing the above, make sure that no magnetic object is placed near the subwoofer. Color irregularity may occur as a result of interaction between the subwoofer and the magnetic object.

Examples of possible sources of magnetic interference include: magnetic latches on a TV stand, etc., healthcare devices, toys, etc.

Specifying the speaker parameters

To obtain the best possible surround sound, first specify the distance of the speakers from your listening position, then set the level and balance. Use the test tone to adjust the speaker level and balance to the same level.

Select [SPEAKER SETUP] in the setup display. For details, see “Settings for the Speakers” (page 83).

Playing Discs

Playing Discs



Depending on the DVD or VIDEO CD, some operations may be different or restricted. Refer to the operation details supplied with your disc.

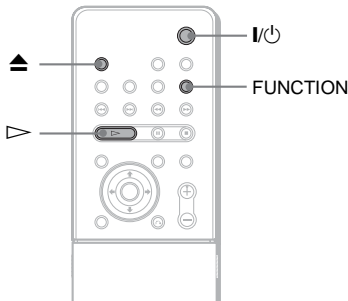
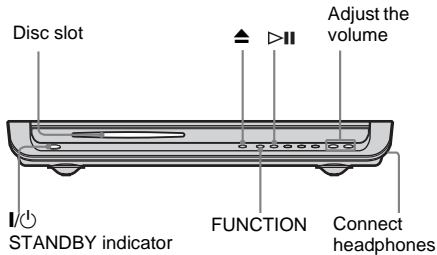

- 1 Turn on your TV.**
- 2 Switch the input selector on the TV to this system.**
- 3 Press I/⏻ on the system.**

The system turns on.

Unless the mode of the system is set to “DVD,” press FUNCTION to select “DVD.”

“NO DISC” appears in the front panel display and the system is ready for loading the disc.

4 Load a disc.

Push the disc into the disc slot until the disc is pulled in automatically.

The disc is drawn into the system automatically and “READING” appears in the front panel display.

With the playback side facing down

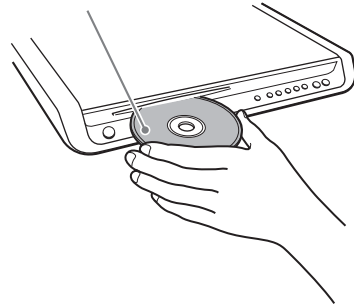

5 Press ▷ on the remote or ▷|| on the system.

The system starts playback (continuous play).

Adjust the volume on the system.

After following Step 5

Depending on the disc, a menu may appear on the TV screen. You can play the disc interactively by following the instructions on the menu. (DVD: page 36), (VIDEO CD: page 36).

To remove the disc

Press ▲. Remove the disc after it is ejected from the system. “NO DISC” appears in the front panel display.

To turn on the system

Press I/⏻ on the system. The system turns on. In standby mode, the system also turns on by loading a disc.

To turn off the system

Press **I/⏻**. The system enters standby mode and the STANDBY indicator lights up in red. To turn off the system completely, remove the AC power cord (mains lead) from the wall outlet (mains).

While playing a disc, do not turn off the system by pressing **I/⏻**. Doing so may cancel the menu settings. When you turn off the system, first press **■** to stop playback and then press **I/⏻**.

To save the power in standby mode

Press **I/⏻** while the system turns on (the STANDBY indicator on the system lights up).

To cancel standby mode

Press **I/⏻** once.

Additional operations

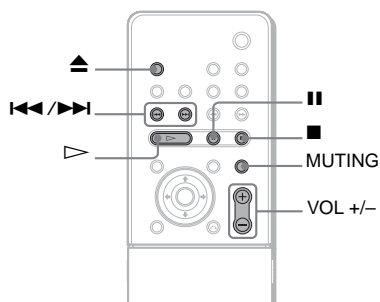

To	Press
Stop	■
Pause*	
Resume play after pause	or ▷
Go to the next chapter, track, scene, or file in continuous play mode	▶▶
Go back to the preceding chapter, track, scene, or file in continuous play mode	◀◀
Stop play and remove the disc	▲
Mute the sound	MUTING. To cancel muting, press it again or VOL + to adjust the sound volume.

* You cannot pause during JPEG playback.

Notes

- If there is no disc in the system, “NO DISC” appears on the front panel display.
- If DVD playback is paused for approximately one hour, the system automatically turns off.

Tip

If a DVD has more than two titles, you cannot go to the next title or go back to the preceding title by pressing **◀◀** or **▶▶**. These buttons work only within a single title. If you want to go to the next title or go back to preceding title, press DVD TOP MENU or DVD MENU and then select the title you want to go to from the control menu.

Resuming Playback from the Point Where You Stopped the Disc

(Resume Play)



When you stop the disc, the system remembers the point where you pressed ■ and “RESUME” appears in the front panel display. As long as you do not remove the disc, Resume Play will work even if the system enters standby mode by pressing I/⏻.

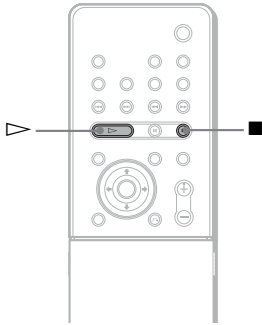

1 While playing a disc, press ■ to stop playback.

“RESUME” appears in the front panel display, so you can restart the disc from the point where you stopped the disc.

If “RESUME” does not appear, Resume Play is not available.

2 Press ▶.

The system starts playback from the point where you stopped the disc in Step 1.

Notes

- You cannot perform Resume Play during Shuffle Play or Program Play.
- Depending on where you stop the disc, the system may not resume playback from exactly the same point.
- The point where you stopped playing is cleared if:
 - you change the play mode.
 - you change the setting on the Setup Menu.

Tip

To play from the beginning of the disc, press ■ twice, then press ▶.

Using the DVD's Menu

DVD

A DVD is divided into a lot of sections, which make up a picture or music feature. These sections are called "titles." When you play a DVD which contains several titles, you can select the title you want using DVD TOP MENU/ALBUM-.

When you play DVDs that allow you to select items such as the language for the subtitles and the language for the sound, select these items using DVD MENU/ALBUM+.

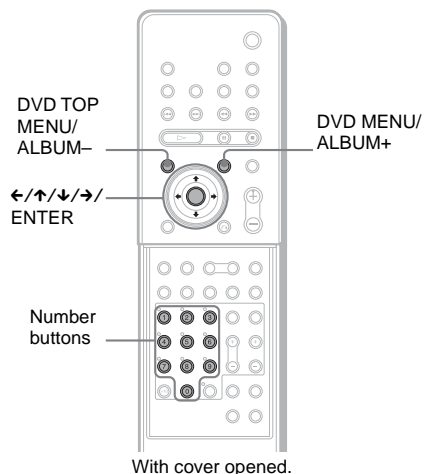

1 Press DVD TOP MENU/ALBUM- or DVD MENU/ALBUM+.

The disc's menu appears on the TV screen. The contents of the menu vary from disc to disc.

2 Press ←/↑/↓/→ or the number buttons to select the item you want to play or change.

3 Press ENTER.

Note

If the DVD top menu or a DVD menu is displayed during DVD playback for approximately one hour, the system automatically turns off.

Playing VIDEO CDs with PBC Functions (Ver. 2.0)

(PBC Playback)

VIDEO CD

With PBC (Playback Control) functions, you can enjoy simple interactive operations, search functions, and other such operations.

PBC playback allows you to play VIDEO CDs interactively by following the menu on the TV screen.

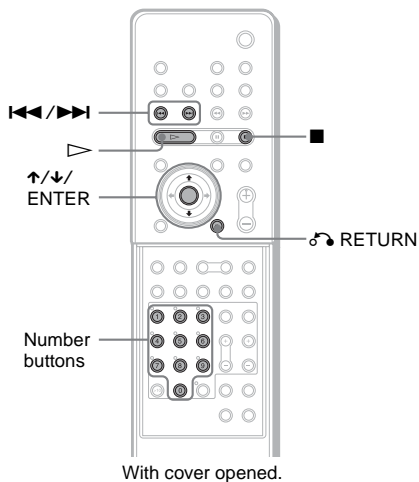

1 Start playing a VIDEO CD with PBC functions.

The menu for your selection appears.

2 Select the item number you want by pressing ↑/↓ or the number buttons.

3 Press ENTER.

4 Follow the instructions in the menu for interactive operations.

Refer to the operation details supplied with the disc, as the operating procedure may differ, depending on the VIDEO CD.

To go back to the menu

Press RETURN.

Notes

- Depending on the VIDEO CD, the menu does not appear in Step 1.
- Depending on the VIDEO CD, “Press ENTER” in Step 3 may appear as “Press SELECT” in the instructions supplied with the disc. In this case, press \triangleright .

Tip

To play without using PBC, press $\blacktriangleleft/\blacktriangleright$ or the number buttons while the system is stopped to select a track, then press \triangleright or ENTER.

“Play without PBC” appears on the TV screen and the system starts continuous play. You cannot play still pictures such as a menu. To return to PBC playback, press \blacksquare twice, then press \triangleright .

Playing an MP3 Audio Track

MP3

You can play MP3 audio tracks on CD-ROMs, CD-Rs, or CD-RWs. However, the discs must be recorded according to ISO9660 level 1, level 2, or Joliet format for the system to recognize the tracks. You can also play discs recorded in Multi Session. See the instructions of the CD-R/RW device or recording software (not supplied) for details on the recording format.

1 Load a data disc recorded in MP3 into the system.

2 Press \triangleright .

The system starts to play the first MP3 audio track in the first album on the disc.

Notes

- The system can play MP3 (MPEG1 Audio Layer3) audio. The system cannot play audio tracks in MP3PRO format.
- This system can play Multi Session CDs when an MP3 audio track is located in the first session. Any subsequent MP3 audio tracks, recorded in the later sessions, can also be played back.
- Maximum number of albums on a disc: 99 (The maximum number of MP3 audio tracks that can be contained on an album is 250.)
- An album that does not include an MP3 audio track is skipped.
- If you put the extension “.MP3” to data not in MP3 format, the system cannot recognize the data properly and will generate a loud noise which could damage your speaker system.
- If the system cannot play MP3, set [DATA CD PRIORITY] to [MP3] in the [CUSTOM SETUP] setting (page 82).
- The system can play to a depth of 8 directories, including a root directory.

Selecting an album and track

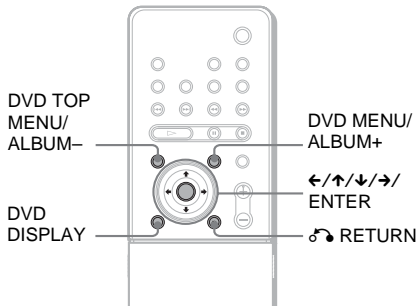

1 Press DVD DISPLAY.

The Control Menu and name of the MP3 data disc appears.

2 Press ↑/↓ to select (ALBUM) then press ENTER or →.

The list of albums contained in the disc appears.

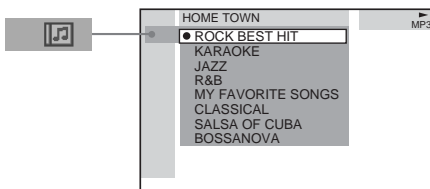

3 Select an album you want to play using ↑/↓ and press ENTER.

4 Select (TRACK) using ↑/↓ and press ENTER.

The list of tracks contained in the current album appears.

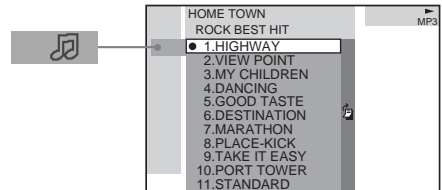

When the list of all tracks or albums cannot be displayed on the window, the jump bar appears. Press → to select the jump bar icon, and then scroll the jump bar to display the rest of the list using ↑/↓. Press ← or ↻ RETURN to return to the track or the album list.

5 Select a track using ↑/↓ and press ENTER.

The selected track starts playing.

To return to the previous display Press ↻ RETURN or ←.

To turn off the display

Press DVD DISPLAY.

Notes

- Only alphabetical letters and numbers can be used for album or track names. Anything else is displayed as “ ”.
- If the MP3 file you play back has an ID3 tag, the ID3 tag information is displayed as a track name.
- ID3 tag applies only to version 1.
- If an MP3 file of VBR (variable bit rate) is played, indicated elapsed time may be different from the actual time.
- Until playing the disc or selecting an album in step 2, album name is displayed as “**Album” (** refers to a number) in the Control Menu, after which the album name is displayed.

Tip

When an MP3 data disc is inserted, you can select an album using the DVD MENU/ALBUM+ or DVD TOP MENU/ALBUM- on the remote.

Playing JPEG Image Files

JPEG

You can play JPEG image files on CD-ROMs, CD-Rs, or CD-RWs. However, the discs must be recorded according to ISO9660 level 1, level 2 or Joliet format for the system to recognize the files. You can also play discs recorded in Multi Session. See the instructions of the CD-R/RW device or recording software (not supplied) for details on the recording format.

1 Load a data disc recorded in JPEG into the system.

2 Press \blacktriangle .

The system starts to play the first JPEG image file in the first album on the disc.

Notes

- The system can play the extension “.JPG” or “.JPEG.”
- The system can play Multi Session CDs.
- An album that does not include a JPEG file is skipped.
- If the system cannot play JPEG, set [DATA CD PRIORITY] to [JPEG] in the [CUSTOM SETUP] setting (page 82).
- A JPEG image file of a length or width of more than 4,720 dots cannot be played.
- A JPEG image file with a high width to length ratio cannot be displayed.
- Some CD-Rs or CD-RWs cannot be played on this system depending on file format.
- The system can play to a depth of 8 directories, including a root directory.
- Progressive JPEG image files cannot be played on this system.
- Maximum number of albums on a disc: 99 (The maximum number of JPEG image files that can be contained on an album is 250.)

Tip

When you go to the next file or to go back to the previous file, press $\blacktriangle\blacktriangle$ or $\blacktriangle\blacktriangle$.

Selecting an album and file

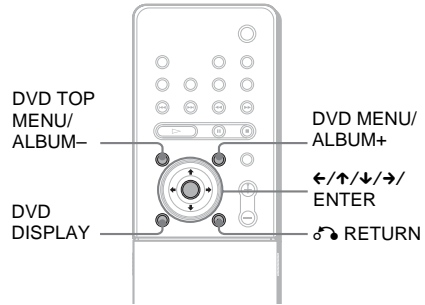

1 Press DVD DISPLAY.

The Control Menu and name of the JPEG data disc appears.

2 Press \uparrow/\downarrow to select  (ALBUM) then press ENTER or \rightarrow .

The list of albums contained in the disc appears.

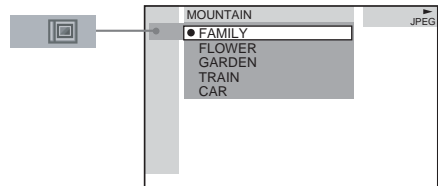

3 Select an album you want to play using \uparrow/\downarrow and press ENTER.

4 Select  (FILE) using \uparrow/\downarrow and press ENTER.

The list of files contained in the current album appears.

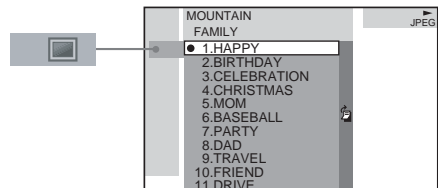

When the list of all files or albums cannot be displayed on the window, the jump bar appears. Press **→** to select the jump bar icon, and then scroll the jump bar to display the rest of the list using **↑/↓**. Press **←** or **↶** RETURN to return to the file or the album list.

5 Select a file using ↑/↓ and press ENTER.

The selected file starts playing.

To return to the previous display

Press **↶** RETURN or **←**.

To turn off the display

Press DVD DISPLAY.

Notes

- Only alphabetical letters and numbers can be used for album or file names. Anything else is displayed as “ ”.
- Until playing the disc or selecting an album in step 2, album name is displayed as “**Album” (** refers to a number) in the Control Menu, after which the album name is displayed.

Tip

When a JPEG data disc is inserted, you can select an album using the DVD MENU/ALBUM+ or DVD TOP MENU/ALBUM- on the remote.

Enjoying Slide show on a JPEG data disc

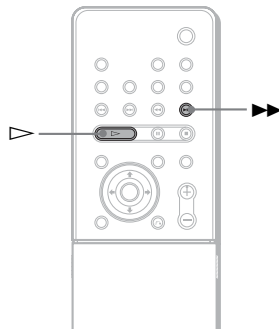

1 Press ►► while displaying a JPEG image.

Slide show starts from the current image.

2 Press ◁ when you want to exit Slide show.

Return to normal play from the current image.

To change the interval time of Slide show

Each time you press ►► during Slide show, the interval time changes. With each press, the indication changes as follows:

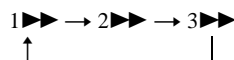

The 3 ►► interval time is faster than 2 ►►.

Note

Slide show can play in only one direction.

To rotate the current image

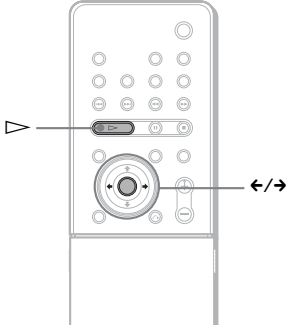

Rotate the current image using ←/→.

Each time you press →, the image turns clockwise by 90°.

Each time you press ←, the image turns anticlockwise by 90°.

Note

You cannot rotate the image during Slide show. Press ▷ to return to normal play before this operation.

Creating Your Own Program

(Program Play)



You can play the contents of a disc in the order you want by arranging the order of the tracks on the disc to create your own program. You can program up to 25 tracks.

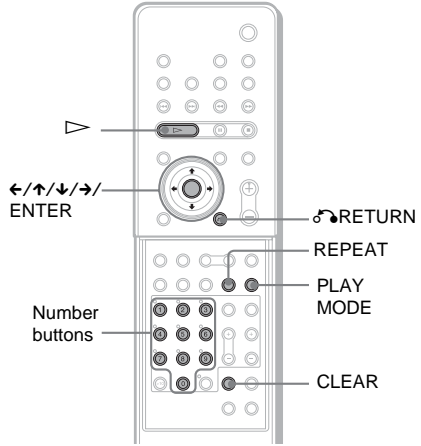

With cover opened.

- In stop mode, press PLAY MODE repeatedly until “PGM” appears in the front panel display.**

The Program Menu appears on the TV screen.

For example, select a track on an MP3 disc.

Program	Total Time
1	
2	
3	
4	
5	
6	
7	
8	
9	
10	

To check the tracks or albums that you have already created once, press **←** to select the jump bar icon, and then scroll the jump bar to display the rest of the list using **↑/↓**. Press **→** or **↶** RETURN to return to the track list.

You can select the jump bar icon only if there are more than 9 programmed tracks or albums.

2 Press **→**.

The cursor moves to the track (in this case, "1"). Before programming the MP3 tracks, it is required to select the album.

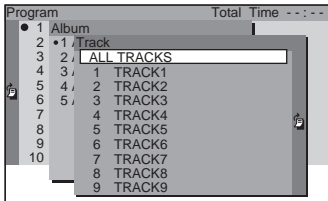

To select a track that is not displayed on the window, press **→** to select the jump bar icon, and then scroll the jump bar to display the rest of the list using **↑/↓**. Press **←** or **↶** RETURN to return to the track list.

You can select the jump bar icon only if there are more than 9 tracks.

3 Select the track you want to program.

For example, select track "7."

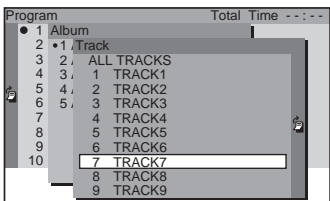

4 Press **↑/↓** or the number buttons to select "7" then press **ENTER**.

Total time of the programmed tracks (except MP3)

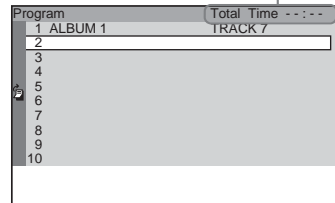

5 To program other tracks, repeat Steps 2 to 4.

The programmed tracks are displayed in the selected order.

6 Press **▷** to start Program Play.

Program Play begins.

When the program ends, you can restart the same program again by pressing **▷**.

To return to normal play

In stop mode, press **PLAY MODE** repeatedly until "PGM" disappears from the front panel display.

Other Operations

To	Do this
Turn off the Program Menu	In stop mode, press PLAY MODE to turn off the Program Menu.
Cancel the programmed order	Press CLEAR in Step 5, and the last program is cancelled one by one.

Notes

- Program Play function is not available for DVDs and JPEG.
- When you remove the disc, Program Play is cancelled and the program you created is cleared.
- When you program MP3 tracks, "--:--" is displayed as the total time of the programmed tracks.

Tip

You can perform Repeat Play of programmed tracks. Press **REPEAT**, or set **[REPEAT]** to **[ALL]** in the Control Menu display during Program Play (page 44).

Playing in Random Order

(Shuffle Play)



You can have the system “shuffle” tracks and play them in random order. Subsequent “shuffling” will produce a different playing order.

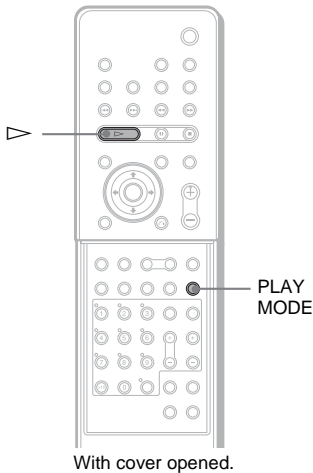

- 1 In stop mode, press PLAY MODE repeatedly until “SHUF” appears in the front panel display.**

When you play an MP3 disc, you can play all tracks in albums in random order. For details on album shuffle, see page 43.

- 2 Press \blacktriangleright .**

To return to normal play

In stop mode, press PLAY MODE repeatedly until “SHUF” disappears from the front panel display (SHUFFLE cancelled). The same applies to cancel SHUFFLE (ALBUM).

Setting the shuffle mode in the Control Menu

You can select either normal shuffle or album shuffle (MP3 only).

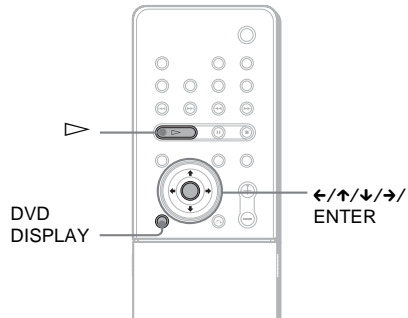

- 1 Press DVD DISPLAY.**
The Control Menu appears.
- 2 Press \uparrow/\downarrow to select **PLAY MODE (PLAY MODE)**, then press ENTER or \rightarrow .**

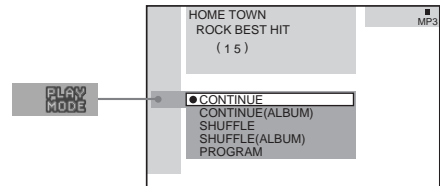

- 3 Select [SHUFFLE] or [SHUFFLE (ALBUM)] using \uparrow/\downarrow and press ENTER.**

[SHUFFLE]: Plays tracks on the disc in random order.

[SHUFFLE (ALBUM)]: Plays tracks from selected album in random order.

- 4 Press \blacktriangleright .**

The selected Shuffle Play begins.

Note

Shuffle Play is cancelled when you eject the disc. The play mode changes in the following sequence:

SHUFFLE → CONTINUE

SHUFFLE (ALBUM) → CONTINUE (ALBUM)

Playing Repeatedly

(Repeat Play)



You can play all the titles/tracks/files or a single title/chapter/track on a disc.

In Shuffle or Program Play mode, the system repeats tracks in shuffled or programmed order.

You cannot perform Repeat Play during PBC playback of VIDEO CDs (page 36).

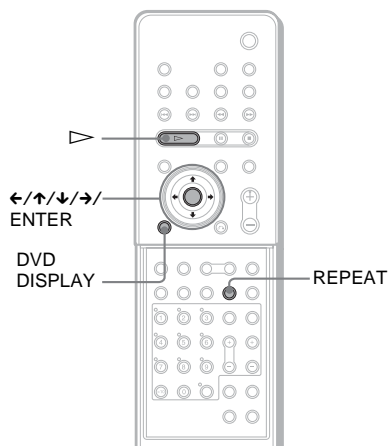

With cover opened.

- 1 Press DVD DISPLAY.**
The Control Menu appears.
- 2 Press \uparrow/\downarrow to select [REPEAT], then press ENTER or \rightarrow .**
If you do not select [OFF], the [REPEAT] indicator lights in green.
- 3 Select the Repeat Play setting, then press ENTER.**

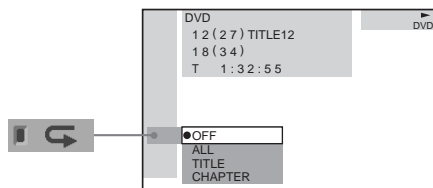

■ When playing a DVD

- **OFF:** does not play repeatedly.
- **ALL:** repeats all the titles.
- **TITLE:** repeats the current title on a disc.
- **CHAPTER:** repeats the current chapter.

■ When playing a VIDEO CD/Super Audio CD/CD/MP3, and when Program Play is set to OFF

- **OFF:** does not play repeatedly.
- **ALL:** repeats all the tracks on the disc, or repeats the current album (only when CONTINUE (ALBUM) or SHUFFLE (ALBUM) in the play mode is selected).
- **TRACK:** repeats the current track.

■ When playing a JPEG

- **OFF:** does not play repeatedly.
- **ALL:** repeats all the files on the disc (when CONTINUE is selected in the play mode), or repeats the current album (when CONTINUE (ALBUM) is selected in the play mode).

■ When Program Play is set to ON

- **OFF:** does not play repeatedly.
- **ALL:** repeats Program Play.

Notes

- Depending on the DVD disc, Repeat Play does not work.
- Repeat Play is cancelled when you eject the disc.
- If [ALL] is selected, Repeat Play is limited to 5 times.

Tips

- You can set Repeat Play during stop mode. After selecting the [REPEAT] item, press \triangleright . The system starts Repeat Play.
- You can quickly display the [REPEAT] status. Press REPEAT on the remote.
- You can perform Repeat Play for DVD titles that contain chapters.

Searching for a Particular Point on a Disc

(Scan, Slow-motion Play)



You can locate a particular point on a disc quickly by monitoring the picture or by playing back slowly.

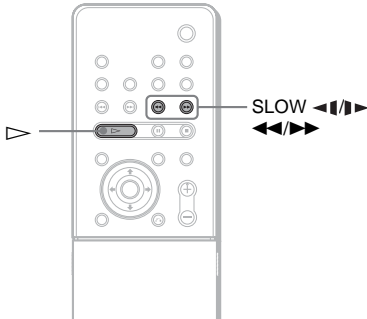

Notes

- Depending on the DVD/VIDEO CD, you may not be able to perform some of the operations described.
- During Scan or Slow-motion Play, no sound is output.

Locating a point quickly by playing a disc in fast forward or fast reverse (Scan)

- 1 Press ◀◀ or ▶▶ while playing a disc.
- 2 When you find the point you want, press ▷ to return to normal speed.

To change the scan speed (DVD/VIDEO CD only)

Each time you press ◀◀ or ▶▶ during scan, the playback speed changes. Two speeds are available. With each press, the indication changes as follows:

Playback direction

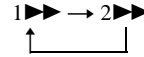

Opposite direction

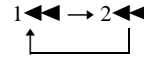

The 2▶▶/2◀◀ playback speed is faster than 1▶▶/1◀◀.

Watching frame by frame (Slow-motion Play) (DVD/VIDEO CD only)

Press ◀◀ or ▶▶ when the system is in the pause mode.

To return to normal speed, press ▷.

To change the speed of Slow-motion Play

Each time you press ◀◀ or ▶▶ during Slow-motion Play, the playback speed changes. Two speeds are available. With each press, the indication changes as follows:

Playback direction

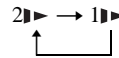

Opposite direction (DVD only)

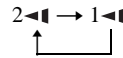

The 2▶▶/2◀◀ playback speed is slower than 1▶▶/1◀◀.

Searching for a Title/ Chapter/Track/Index/ Album/File



You can search a title (DVD), chapter (DVD), track (CD, VIDEO CD, Super Audio CD, MP3), index (VIDEO CD, Super Audio CD), album (MP3, JPEG), and file (JPEG). As titles, tracks, albums and files are assigned unique names on the disc, you can select the desired one from the Control Menu. Also chapters and indexes are assigned unique numbers on the disc, so you select the desired one by entering its number. Or you can search a particular point using the time code (TIME SEARCH).

You cannot search a scene of a VIDEO CD (when the PBC function is on).

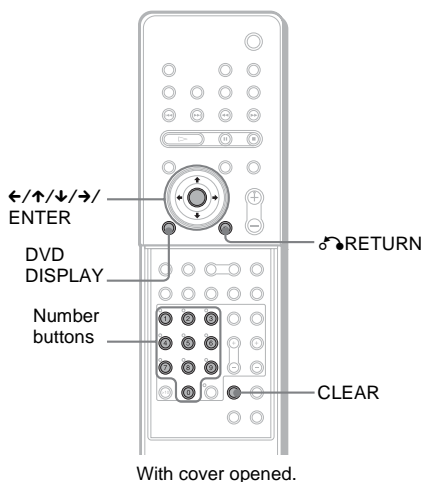

Searching for a title/track/ album/file

- 1 Press DVD DISPLAY.**
The Control Menu appears.
- 2 Press \uparrow/\downarrow to select the search method, then press ENTER or \rightarrow .**

■ When playing a DVD



■ When playing a VIDEO CD



■ When playing a Super Audio CD

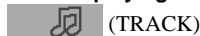

■ When playing a CD

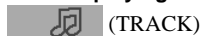

■ When playing an MP3

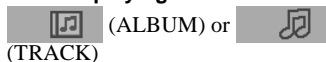

■ When displaying a JPEG file

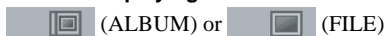

Example: when you select (TRACK)

The list of tracks contained in the disc appears.

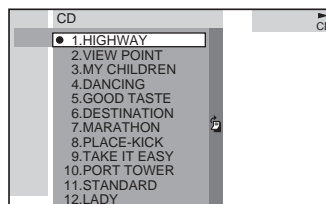

When the list of all tracks or albums cannot be displayed on the window, the jump bar appears. Press \rightarrow to select the jump bar icon, and then scroll the jump bar to display the rest of the list using \uparrow/\downarrow . Press \leftarrow or \hookrightarrow RETURN to return to the track or the album list.

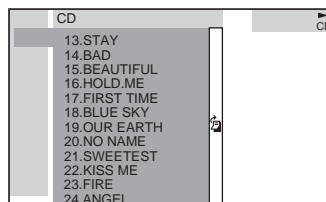

- 3 Press \uparrow/\downarrow to select the desired track, then press ENTER.**

The system starts playback from the selected track.

Searching for a chapter/index

1 Press DVD DISPLAY.

The Control Menu appears.

2 Press \uparrow/\downarrow to select the search method.

■ When playing a DVD

 (CHAPTER)

■ When playing a VIDEO CD (without PBC functions)

 (INDEX)

■ When playing a Super Audio CD

 (INDEX)

Example: when you select  (CHAPTER)

“** (**)” is selected (** refers to a number).

The number in parentheses indicates the total number of chapters or indexes.

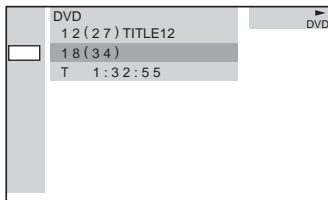

3 Press ENTER or \rightarrow .

“** (**)” changes to “-- (**).”

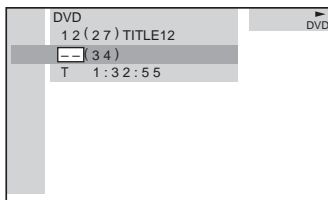

4 Press \uparrow/\downarrow or the number buttons to select the chapter or index number you want to search.

If you make a mistake

Cancel the number by pressing CLEAR, then select another number.

5 Press ENTER.

The system starts playback from the selected number.

Note

When you play a VIDEO CD with PBC functions, the index search function does not work.

To turn off the Control Menu

Press DVD DISPLAY repeatedly until the Control Menu is turned off.

To search for a particular point using the time code (TIME SEARCH)

Example: If you search for the playing time of the current title on a DVD

1 In Step 2, select (TIME).

“T **: **: **” (playing time of the current title) is selected.

2 Press ENTER or \rightarrow .

“T--:--:--” appears above “T **: **: **.”

3 Input the time code using the number buttons, then press ENTER.

For example, to find a desired point at 2 hours, 10 minutes, and 20 seconds after the beginning, just enter “2:10:20.”

Notes

- The title, chapter or track number displayed is the same number recorded on the disc.
- The time search function does not work on a VIDEO CD (when the PBC function is on).
- If you play a DVD, input the playing time of the current title using the time code. If you play a CD, Super Audio CD, VIDEO CD, or MP3, input the playing time of the current track using the time code.

Tip

You can change the display to show playing time or remaining time. For details, see “Checking the Playing Time and Remaining Time” (page 50).

Viewing Disc Information



Viewing the playing time and remaining time in the front panel display

You can check disc information, such as the remaining time, total number of titles in a DVD, or tracks in a Super Audio CD, CD, VIDEO CD, or MP3, using the front panel display (page 99).

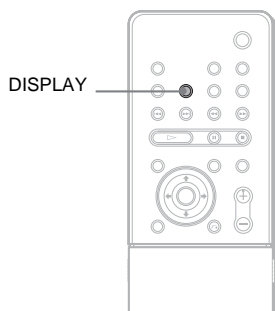

Press DISPLAY.

Each time you press DISPLAY while playing the disc, the display changes as shown in the charts.

When playing back a DVD

Playing time and number of the current title

TITLE	CHAP	
1	2	122:30

Remaining time and number of the current title

TITLE	CHAP	
1	2	-1:10:30

Playing time and number of the current chapter

CHAP	
2	012:30

Remaining time and number of the current chapter

CHAP	
2	-005:30

Title name

SONY

Current sound field

A. F. D. AUTO

When playing back a VIDEO CD (without PBC functions), Super Audio CD or CD

Playing time and current track number

TRK 3 230

Remaining time and current track number

TRK 3 - 130

Playing time of the disc

1230

Remaining time of the disc

- 3 130

Track name

SONY

Current sound field

A F. D. AUTO

When playing back an MP3

Playing time and current track number

TRK 3 230

Remaining time of the current track

TRK 3 - 130

Track (file) name

SONY

Album (folder) name

SONY ROCK

Current sound field

A F. D. AUTO

When playing back a JPEG

Current file number

12

File name

SONY

Album (folder) name

SONY ROCK

Current sound field

A F. D. AUTO

Notes

- Depending on the type of disc being played and the playing mode, the disc information may not be displayed.
- ID3 tag applies only to version 1.
- If the MP3 file you play back has an ID3 tag, the ID3 tag information is displayed as a track (file) name.
- Only alphabetical letters and numbers can be used for album, track, or file names. Anything else is displayed as “ ”.
- In the following case, elapsed playing time and current track remaining time may not be displayed accurately.
 - when an MP3 file of VBR (variable bit rate) is played.

Tips

- When playing VIDEO CDs with PBC functions, only the playing time of the scene is displayed.
- The playing time and remaining time of the current chapter, title, track, scene, or disc will also appear on your TV screen. See the following section “Checking the Playing Time and Remaining Time” for details on how to read this information.

Checking the Playing Time and Remaining Time

You can check the playing time and remaining time of the current title, chapter, or track, and the total playing time or remaining time of the disc. You can also check the DVD/CD/Super Audio CD text and MP3 folder name/file name/ID3 tag (only song title) recorded on the disc.

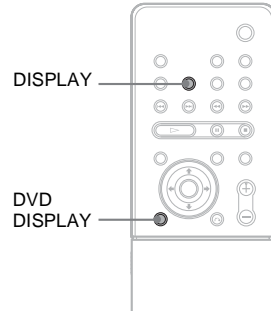

1 Press DVD DISPLAY during playback.

The Control Menu appears.

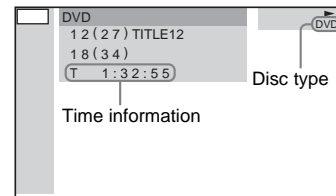

2 Press DISPLAY repeatedly to change the time information.

The display and the kinds of time that you can check depend on the disc you are playing.

■ When playing a DVD

- T **.*:*.**
Playing time of the current title
- T_**.*:*.**
Remaining time of the current title
- C **.*:*.**
Playing time of the current chapter

- C_**:**.**
- Remaining time of the current chapter
- **:**:**
- Playing time of the menu or current title without a chapter

■ **When playing a VIDEO CD (with PBC functions)**

- **:**
- Playing time of the current scene

■ **When playing a VIDEO CD (without PBC functions), Super Audio CD or CD**

- T **.**
- Playing time of the current track
- T_**.**
- Remaining time of the current track
- D **.**
- Playing time of the current disc
- D_**.**
- Remaining time of the current disc

■ **When playing an MP3**

- T **.**
- Playing time of the current track
- T_**.**
- Remaining time of the current track

To turn off the Control Menu

Press DVD DISPLAY repeatedly until the Control Menu is turned off.

Notes

- Only alphabetical letters and numbers can be displayed.
- Depending on the type of disc being played, the system can only display a limited number of characters. Also, depending on the disc, not all text characters will be displayed.

Checking the date information (JPEG only)

You can check the date information during playback when the Exif* tag is recorded in the JPEG image data.

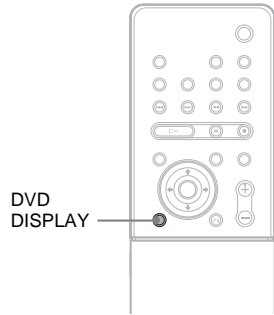

Press DVD DISPLAY during playback.

The Control Menu appears.

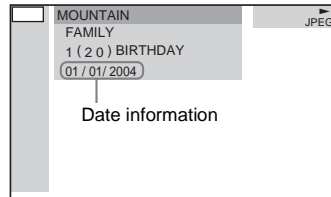

* “Exchangeable Image File Format” is a digital camera image format defined by the Japan Electronics and Information Technology Industries Association (JEITA).

Note

If there is no date information or data is damaged on the disc, the system cannot display the date information.

Tip

You can change the date information order in [JPEG DATE] of [CUSTOM SETUP] (page 82).

Sound Adjustments

Changing the Sound



If a DVD is recorded with multilingual tracks, you can select the language you want while playing the DVD.

If the DVD is recorded in multiple audio formats (PCM, Dolby Digital, MPEG audio, or DTS), you can select the audio format you want while playing the DVD.

With stereo CDs, VIDEO CDs, or MP3, you can select the sound from the right or left channel and listen to the sound of the selected channel through both the right and left speakers (in this case, the sound loses its stereo effect). For example, when playing a disc containing a song with the vocals on the right channel and the instruments on the left channel, you can select the left channel and hear only the instruments from both speakers.

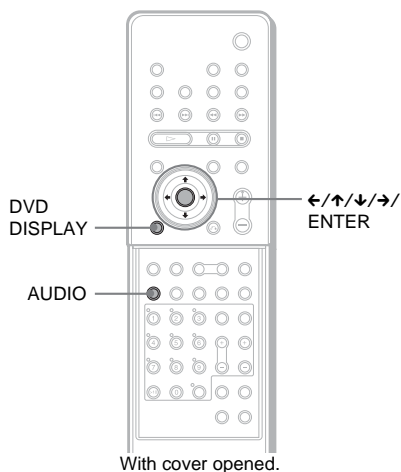

- 1 Press DVD DISPLAY during playback.**
The Control Menu is displayed.

- 2 Press \uparrow/\downarrow to select  (AUDIO), then press ENTER or \rightarrow .**

The options for AUDIO appear.

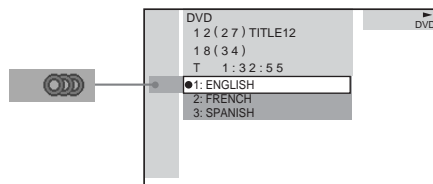

- 3 Press \uparrow/\downarrow to select the desired audio signal.**

■ When playing a DVD

Depending on the DVD, the choice of language varies.

When 4 digits are displayed, they represent the language code. Refer to the language code list on page 103 to see which language the code represents. When the same language is displayed two or more times, the DVD is recorded in multiple audio formats.

■ When playing a VIDEO CD, CD, or MP3

The default setting is underlined.

- STEREO: The standard stereo sound
- 1/L: The sound of the left channel (monaural)
- 2/R: The sound of the right channel (monaural)

■ When playing a Super Audio CD

In stop mode, depending on the Super Audio CD, the choice of settings varies.

- MULTI: The disc has a multi-channel playback area.
- 2CH: The disc has a 2 channel playback area.
- CD: When you want to play the disc as a conventional CD.

Notes

- Not all discs give you the three choices above when in Super Audio CD playback. It all depends on the layer configuration of the Super Audio CD to be played.
- When playing a Super Audio CD in the 2 channel playback area or the 2 CHANNEL STEREO mode, the POWER/ON LINE indicator of the surround amplifier turns red.

4 Press ENTER.

To turn off the Control Menu

Press DVD DISPLAY repeatedly until the Control Menu is turned off.

Notes

- For discs not in multiple audio format, you cannot change the sound.
- During DVD playback, the sound may change automatically.

Tip

You can select [AUDIO] directly by pressing AUDIO. Each time you press the button, the item changes.

Displaying the audio information of the disc (DVD only)

When you select [AUDIO], the channels being played are displayed on the screen.

For example, in Dolby Digital format, multiple signals ranging from monaural to 5.1 channel signals can be recorded on a DVD. Depending on the DVD, the number of recorded channels may differ.

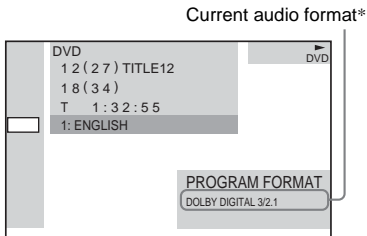

* [PCM], [MPEG], [DTS], or [DOLBY DIGITAL] is displayed.

For [DOLBY DIGITAL], the channels in the playing track are displayed numerically as follows:

For Dolby Digital 5.1 ch:

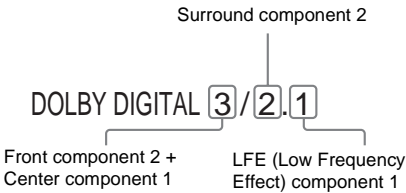

The display examples are as follows:

- PCM (stereo)



- Dolby Surround



- Dolby Digital 5.1ch



- DTS

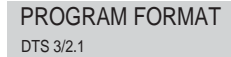

Tips

- When the signal contains surround signal components such as LS, RS, or S, the surround effect is enhanced.
- If you play MPEG AUDIO sound tracks, the system outputs PCM (stereo) signals.
- Even though the audio stream contains a surround back component, the surround back channel is not displayed. Dolby Digital-EX or DTS-ES source is displayed as “3/2.1” on the screen.

Enjoying Surround Sound



You can take advantage of surround sound simply by selecting one of system's pre-programmed sound fields. They bring the exciting and powerful sound of movie theaters into your home.

To select sound field, press AUTO FORMAT DIRECT or MODE on the remote repeatedly until the sound field you want appears in the front panel display.

Tip

When you want to output the TV sound or stereo sound of a 2 channel source from the 6 speakers of the system, select a sound field other than "AUTO FORMAT DIRECT AUTO" or "2 CHANNEL STEREO".

Automatic decoding of the audio input signal (AUTO FORMAT DIRECT AUTO)

The auto decoding function automatically detects the type of audio signal being input (Dolby Digital, DTS, or standard 2 channel stereo) and performs the proper decoding if necessary. This mode presents the sound as it was recorded/encoded, without adding any effects (e.g. reverberation).

However, if there are no low frequency signals (Dolby Digital LFE, etc.), it will generate a low frequency signal for output to the subwoofer.

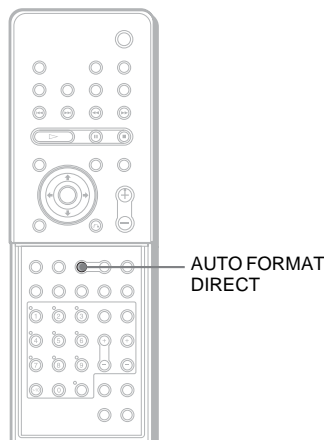

With cover opened.

Press AUTO FORMAT DIRECT repeatedly until "A.F.D. AUTO" appears in the front panel display.

Sound field	Display
AUTO FORMAT DIRECT	A.F.D. AUTO
AUTO	AUTO

Using only the front speaker and subwoofer (2 CHANNEL STEREO)

This mode outputs the sound from the front left and right speakers and subwoofer. Standard two channel (stereo) sources completely bypass the sound field processing. Multi channel surround formats are downmixed to two channels.

This allows you to play any source using only the front left and right speakers and subwoofer.

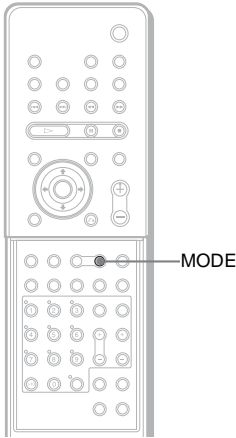

With cover opened.

Press MODE repeatedly until “2CH STEREO” appears in the front panel display.

Sound field	Display
2 CHANNEL STEREO	2CH STEREO

Selecting a sound field (AUTO FORMAT DIRECT button)

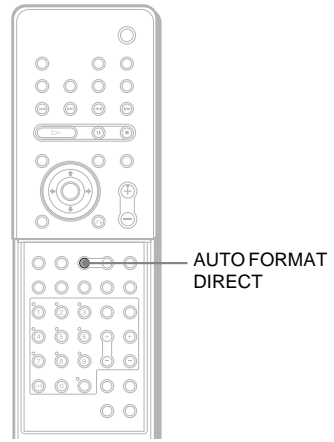

With cover opened.

Press AUTO FORMAT DIRECT repeatedly until the sound field you want appears in the front panel display.

Sound field	Display
AUTO FORMAT DIRECT PRO LOGIC	DOLBY PL
AUTO FORMAT DIRECT PRO LOGIC II MOVIE	PLII MOVIE
AUTO FORMAT DIRECT PRO LOGIC II MUSIC	PLII MUSIC
Neo:6 CINEMA	NEO:6 CIN
Neo:6 MUSIC	NEO:6 MUS

■ **AUTO FORMAT DIRECT PRO LOGIC**

Dolby Pro Logic produces five output channels from two-channel sources. This mode performs Pro Logic decoding to the input signal and output to front, center, and surround speakers. Meanwhile, the surround channel becomes monaural.

■ AUTO FORMAT DIRECT PRO LOGIC II MOVIE/MUSIC

Dolby Pro Logic II produces five full-bandwidth output channels from two-channel sources. This is done using an advanced, high-purity matrix surround decoder that extracts the spatial properties of the original recording without adding any new sounds or tonal colorations.

■ Neo:6 CINEMA

Performs the DTS Neo:6 Cinema mode decoding.

■ Neo:6 MUSIC

Performs the DTS Neo:6 Music mode decoding. This setting is ideal for standard stereo sources, such as CDs.

Notes

- When the input signal is a multi-channel source, PRO LOGIC, PRO LOGIC II MOVIE/MUSIC, and Neo:6 Cinema/Music are cancelled and the multi channel source is output directly.
- Neo:6 Cinema/Music mode decoding is not available for DTS 2channel signal.
- This system is not compatible with the DTS 96/24 decoding function. When you play the DTS 96/24 disc, the system plays it as a normal disc.

Selecting a sound field (MODE button)

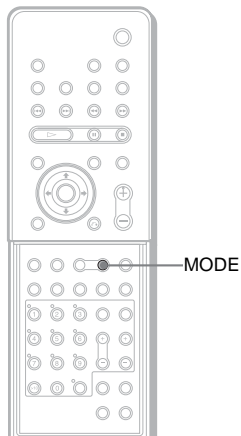

With cover opened.

Press MODE repeatedly until the sound field you want appears in the front panel display.

For movie

Sound field	Display
CINEMA STUDIO EX A	C. ST. EX A*
CINEMA STUDIO EX B	C. ST. EX B*
CINEMA STUDIO EX C	C. ST. EX C*

*Use DCS Technology

About DCS (Digital Cinema Sound)

In collaboration with Sony Pictures Entertainment, Sony measured the sound environment of their studios and integrated the data of the measurement and Sony's own DSP (Digital Signal Processor) technology to develop "Digital Cinema Sound." "Digital Cinema Sound" simulates in a home theater an ideal movie theater sound environment based on the preference of the movie director.

■ C. ST. EX A (Cinema Studio EX A)

Reproduces the sound characteristics of the Sony Pictures Entertainment "Cary Grant Theater" cinema production studio. This is a standard mode, great for watching most any type of movie.

■ C. ST. EX B (Cinema Studio EX B)

Reproduces the sound characteristics of the Sony Pictures Entertainment “Kim Novak Theater” cinema production studio. This mode is ideal for watching science-fiction or action movies with lots of sound effects.

■ C. ST. EX C (Cinema Studio EX C)

Reproduces the sound characteristics of the Sony Pictures Entertainment scoring stage. This mode is ideal for watching musicals or classic films where music is featured in the soundtrack.

About Cinema Studio EX

Cinema Studio EX is ideal for enjoying the movie software encoded with multi channel format, such as the Dolby Digital DVD. This mode reproduces the sound characteristics of Sony Pictures Entertainment’s studios. Cinema Studio EX consists of the following three elements.

- **Virtual Multi Dimension**
Creates 5 sets of virtual speakers surrounding the listener from a single pair of actual surround speakers.
- **Screen Depth Matching**
In a movie theater, sound seems to come from inside the image reflected on the movie screen. This element creates the same sensation in your listening room by shifting the sound of the front speakers “into” the screen.
- **Cinema Studio Reverberation**
Reproduces the reverberations peculiar to a movie theater. Cinema Studio EX is the integrated mode which operates these elements simultaneously.

Notes

- The virtual speaker effect may cause increased noise in the playback signal.
- When listening with sound fields that employ virtual speakers, you will not be able to hear any sound coming directly from the surround speakers.

For music or others

Sound field	Display
HALL	HALL
JAZZ CLUB	JAZZ CLUB
LIVE CONCERT	L. CONCERT
GAME	GAME
SPORTS	SPORTS
MONO MOVIE	MONO MOVIE

■ HALL (Hall)

Reproduces the acoustics of a rectangular concert hall.

■ JAZZ CLUB (Jazz club)

Reproduces the acoustics of a jazz club.

■ L. CONCERT (Live concert)

Reproduces the acoustics of a 300-seat live concert.

■ GAME (Game)

Obtains maximum audio impact from video game software.

■ SPORTS (Sports)

Simulates the arena or stadium sound.

■ MONO MOVIE (Mono movie)

Reproduces mono sound that is good for old movies.

When using headphones

Sound field	Display
HEADPHONE 2CH	HP 2CH
HEADPHONE THEATER	HP THEATER

■ HEADPHONE 2CH

This mode outputs the sound from the headphone L/R. Standard 2 channel (stereo) sources completely bypass the sound field processing. Multi channel surround formats are downmixed to two channels.

■ HEADPHONE THEATER

This mode outputs the sound as surround from headphone L/R.

To turn the surround effect off
Press AUTO FORMAT DIRECT repeatedly until “A.F.D. AUTO” appears in the front panel display.

When connecting the headphones to the PHONES jack

Press AUTO FORMAT DIRECT or MODE repeatedly until “HP 2CH” appears in the front panel display.

Notes



- This function is unavailable when playing Super Audio CDs and when the input stream is dts 2048 frame.
- When you play a Super Audio CD (Direct Stream Digital), the sound field changes to “AUTO FORMAT DIRECT AUTO” automatically.
- This system is not compatible with the DTS 96/24 decoding function. When you play the DTS 96/24 disc, the system plays it as a normal disc.

Tips

- When you want to output the TV sound or stereo sound of a 2 channel source from the 6 or 7 speakers, select any sound field other than “AUTO FORMAT DIRECT AUTO” or “2CH STEREO.”

- The system memorizes the last sound field selected for each function mode.

Whenever you select a function such as DVD or TUNER, the sound field that was last applied to function is automatically applied again. For example, if you listen to DVD with HALL as the sound field, then change to another function, and then return to DVD, HALL will be applied again. With the tuner, sound fields are memorized separately for all preset stations.

- You can identify the encoding format of program software by looking at its packaging.
 - Dolby Digital discs are labeled with the  logo.
 - DTS-ES encoded programs are marked with DTS-ES.
 - Dolby Surround encoded programs are labeled with the  logo.
 - DTS Digital Surround discs are marked with DTS.

Selecting the Surround Back Decoding Mode

DVD

This function lets you select the decoding mode for the surround back signals of the multi channel input stream.

By decoding the surround back signal of DVD software, etc., recorded in Dolby Digital EX, DTS-ES Matrix, DTS-ES Discrete 6.1 format, etc., you can enjoy the kind of surround sound originally intended for the film (page 94, 95).

Note

This function works only when you connect the surround back speaker to the system (page 16) and set [SURROUND BACK] to [YES] in the [SIZE] setting (page 83).

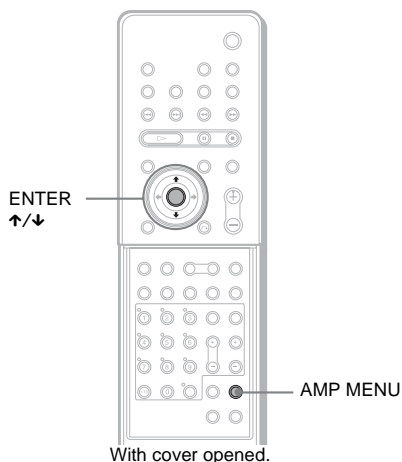

- 1 Press AMP MENU.
- 2 Press ↑/↓ repeatedly until “CUSTOMIZE” appears in the front panel display, then press ENTER.
- 3 Press ↑/↓ repeatedly until “SB DEC” appears in the front panel display, then press ENTER.

4 Press \uparrow/\downarrow to select the surround back mode you want according to the input stream, then press ENTER or AMP MENU.

The default setting is “SB MATRIX.”

When selecting “SB MATRIX”

Dolby Digital EX or DTS-ES is applied to decode the surround back signal regardless of the 6.1 channel decode flag^{a)} in the input stream. This decoder conforms to Dolby Digital EX or DTS-ES.

Input stream	Output channel	Applied surround back decoder
Dolby Digital 5.1	6.1	Matrix decoder conforms to Dolby Digital EX
DTS 5.1	6.1	DTS Matrix decoder
Dolby Digital EX ^{b)}	6.1	Matrix decoder conforms to Dolby Digital EX
DTS-ES Matrix 6.1 ^{c)}	6.1	DTS Matrix decoder
DTS-ES Discrete 6.1 ^{d)}	6.1	DTS Discrete decoder

When selecting “SB AUTO”

When you input stream contains the 6.1 channel decoding flag^{a)}, the appropriate decoder is applied to decode the surround back signal.

Input stream	Output channel	Applied surround back decoder
Dolby Digital 5.1	5.1	—
DTS 5.1	5.1	—
Dolby Digital EX ^{b)}	6.1	Matrix decoder conforms to Dolby Digital EX
DTS-ES Matrix 6.1 ^{c)}	6.1	DTS Matrix decoder
DTS-ES Discrete 6.1 ^{d)}	6.1	DTS Discrete decoder

When selecting “SB OFF”

Surround back decoding is not performed.

- a) 6.1 channel decode flag is information recorded in software like DVD.
- b) Dolby Digital DVD that includes a Surround EX flag. Check the Dolby Corporation web page help for information about Surround EX films.
- c) Software encoded with a flag to denote it has both Surround EX and 5.1 channel signals.
- d) Software encoded with both 5.1 channel signals and an extension stream designed for returning those signals to 6.1 discrete channels. Discrete 6.1 channel signals are DVD specific signals, not used in movie theaters.

Notes

- You can select the surround back decoding only when AUTO FORMAT DIRECT AUTO mode is selected (page 54). In other sound fields, this function is bypassed internally.
- Some discs have no Dolby Digital EX flag, even though their packaging may contain a Dolby Digital Surround EX logo. In this case, select “SB MATRIX.”

Using the Sound Effect

DVD

VIDEO
CD

SA-CD
CD

MP3

This system provides you with 2 types of sound effect, simply by pressing a button. Choose the sound to suit your needs.

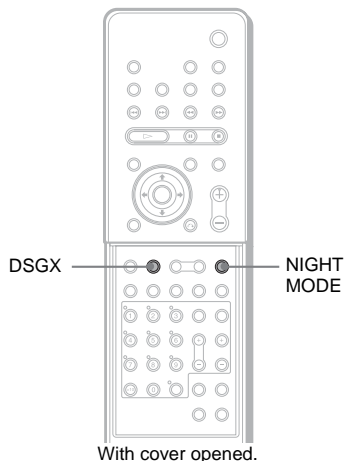

Press NIGHT MODE or DSGX on the remote.

The sound effect is activated.

■ NIGHT MODE

In this mode, you can enjoy sound effects or dialogue, as you would in a movie theater, even at low volume. It is useful for watching movies at night.

■ DSGX

With DSGX on, bass frequencies are effectively reinforced.

To turn off the sound effect

Press NIGHT MODE or DSGX again.

Notes

- The NIGHT MODE function is activated only when the input stream is Dolby Digital format.
- When you connect headphones to the system, the DSGX function does not work.
- These two types of sound effect cannot be activated at the same time.
- Depending on the input stream, the DSGX function may not be effective.

Using Various Additional Functions

Changing the Angles

DVD

If various angles (multi-angles) for a scene are recorded on a DVD, you can change the viewing angle.

For example, while playing a scene of a train in motion, you can display the view from either the front of the train, the left window of the train, or from the right window without having the train's movement interrupted.

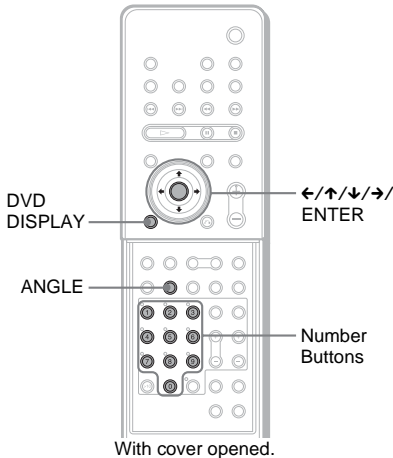

1 Press DVD DISPLAY during playback.

The Control Menu appears.

2 Press \uparrow/\downarrow to select (ANGLE).

The angle number appears.

The number in parentheses indicates the total number of angles. The [ANGLE] indicator lights up in green when angles are recorded on the disc.

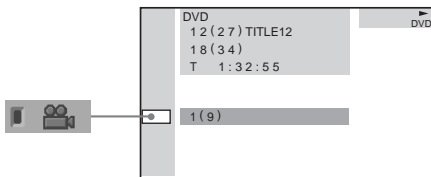

3 Press ENTER or \rightarrow .

The angle number changes to “-.”

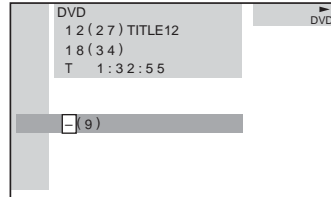

4 Select the angle number using the number buttons or \uparrow/\downarrow , then press ENTER.

The angle is changed to the selected angle.

To turn off the Control Menu

Press DVD DISPLAY repeatedly until the Control Menu is turned off.

Note

Depending on the DVD, you may not be able to change the angles, even if multi-angles are recorded on the DVD.

Tip

You can select the angle directly by pressing ANGLE. Each time you press the button, the angle changes.

Displaying Subtitles

DVD

If subtitles are recorded on a disc, you can turn the subtitles on or off while playing. If multilingual subtitles are recorded on the disc, you can change the subtitle language while playing, or turn the subtitles on or off whenever you want. You can select the language you want to practice, for example, turn on the subtitles for better understanding.

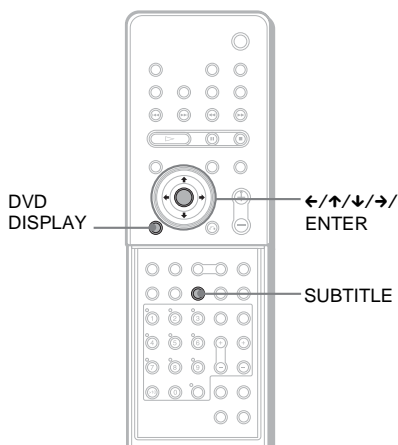

With cover opened.

1 Press DVD DISPLAY during playback.

The Control Menu appears.

2 Press ↑/↓ to select (SUBTITLE), then press ENTER or →.

The options for [SUBTITLE] appear.

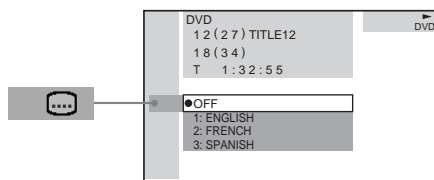

3 Press ↑/↓ to select the language.

Depending on the DVD, the choice of language varies.

When 4 digits are displayed, they indicate the language code. Refer to the language code list on page 103 to see which language the code represents.

4 Press ENTER.

To cancel the [SUBTITLE] setting
Select [OFF] in Step 3.

To turn off the Control Menu

Press DVD DISPLAY repeatedly until the Control Menu is turned off.

Note

Depending on the DVD, you may not be able to change the subtitles, even if multilingual subtitles are recorded on it.

Tip

You can select subtitles directly by pressing SUBTITLE. Each time you press the button, the language changes.

Locking Discs

(CUSTOM PARENTAL CONTROL, PARENTAL CONTROL)



You can set two kinds of playback restrictions for a disc.

- Custom Parental Control

You can set the playback restrictions so that the system will not play inappropriate discs.

- Parental Control

Playback of some DVDs can be limited according to a predetermined level, such as the age of the viewer.

The same password is used for both Parental Control and Custom Parental Control.

Custom Parental Control

You can set the same Custom Parental Control password for up to 25 discs. If you set a 26th disc, the playback restriction of the disc for which you first set the password is cancelled.

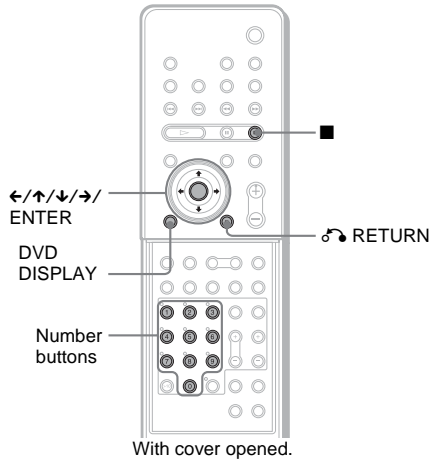

1 Insert the disc you want to lock.

If the disc is playing, press ■ to stop playback.

2 In stop mode, press DVD DISPLAY.

The Control Menu appears.

3 Press ↑/↓ to select (CUSTOM PARENTAL CONTROL), then press ENTER or →.

[CUSTOM PARENTAL CONTROL] is selected.

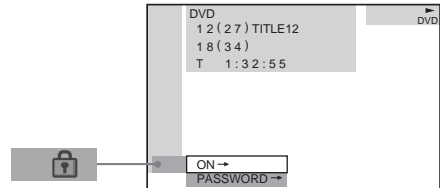

4 Press ↑/↓ to select [ON →], then press ENTER.

■ If you have not entered a password yet

The display for registering a new password appears.

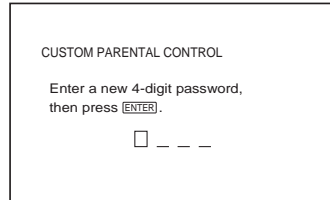

Enter a 4-digit password by using the number buttons, then press ENTER.

The display for confirming the password appears.

■ If you have already registered a password

The display for entering the password appears.

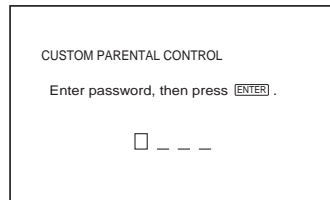

5 Enter your 4-digit password by using the number buttons, then press ENTER.

[Custom parental control is set.] appears and the screen returns to the Control Menu display.

If you make a mistake entering your password

Press **←** before you press ENTER and input the correct number.

If you make a mistake

Press **↶** RETURN, then start from Step 3 again.

To turn off the Control Menu

Press DVD DISPLAY repeatedly until the Control Menu is turned off.

To turn off the Custom Parental Control function

1 In Step 4, select [OFF →], then press ENTER.

2 Enter your 4-digit password using the number buttons, then press ENTER.

To change the password

1 In Step 4, press **↑/↓** to select [PASSWORD →], then press ENTER.

The display for entering the password appears.

2 Enter your 4-digit password using the number buttons, then press ENTER.

3 Enter a new 4-digit password using the number buttons, then press ENTER.

4 To confirm your password, re-enter it using the number buttons, then press ENTER.

Playing the disc for which Custom Parental Control is set

1 Insert the disc for which Custom Parental Control is set.

The [CUSTOM PARENTAL CONTROL] display appears.

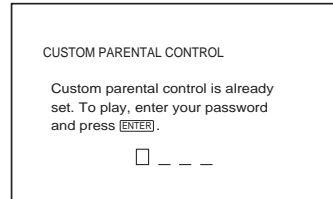

2 Enter your 4-digit password using the number buttons, then press ENTER.

The system is ready for playback.

Notes

- When you change the layer or area in a Super Audio CD which has Custom Parental Control set, the display for entering the password may appear.
- When you set the Custom Parental Control password for a Hybrid Super Audio CD, the Custom Parental Control setting only works for the current layer.

Tip

If you forget your password, enter the 6-digit number "199703" using the number buttons when the [CUSTOM PARENTAL CONTROL] display asks you for your password, then press ENTER. The display will ask you to enter a new 4-digit password.

Limiting playback for children (Parental Control) (DVD only)

Playback of some DVDs can be limited according to a predetermined level, such as the age of the viewer. The “Parental Control” function allows you to set a playback limitation level.

A scene that is limited is not played, or it is replaced by a different scene.

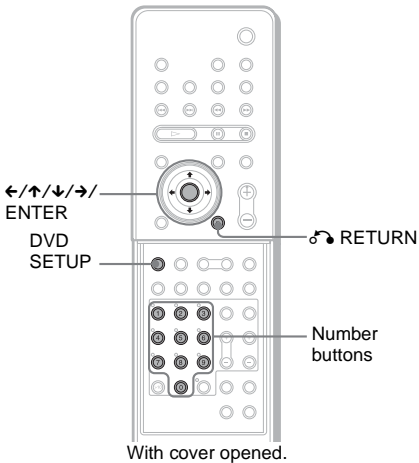

1 In stop mode, press DVD SETUP.

The Setup Display appears.

2 Press ↑/↓ to select [CUSTOM SETUP], then press ENTER or →.

[CUSTOM SETUP] is displayed.

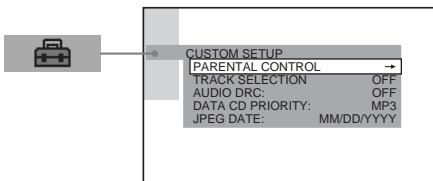

3 Press ↑/↓ to select [PARENTAL CONTROL →], then press ENTER or →.

■ If you have not entered a password

The display for registering a new password appears.

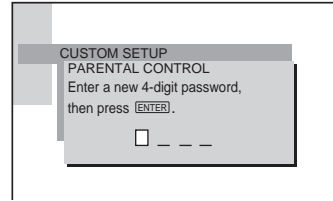

Enter a 4-digit password using the number buttons, then press ENTER.

The display for confirming the password appears.

■ When you have already registered a password

The display for entering the password appears.

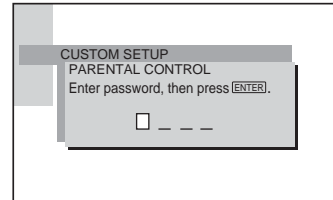

4 Enter your password using the number buttons, then press ENTER.

The display for setting the playback limitation level and changing the password appears.

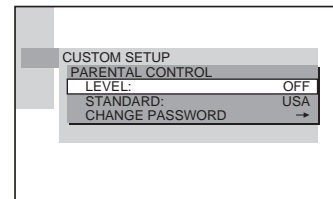

5 Press \uparrow/\downarrow to select [STANDARD], then press ENTER or \rightarrow .

The selection items for [STANDARD] are displayed.

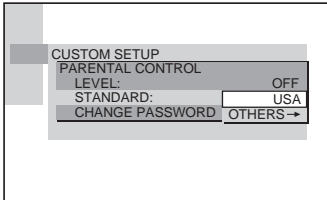

6 Press \uparrow/\downarrow to select a geographic area as the playback limitation level, then press ENTER.

The area is selected.

If you select [OTHERS \rightarrow], select and enter the standard code in the table on page 67 using the number buttons.

7 Press \uparrow/\downarrow to select [LEVEL], then press ENTER or \rightarrow .

The selection items for [LEVEL] are displayed.

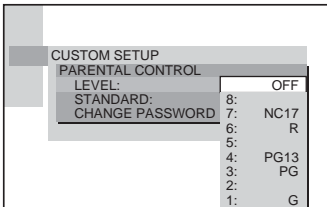

8 Select the level you want using \uparrow/\downarrow , then press ENTER.

The Parental Control setting is complete.

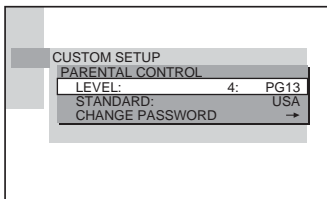

The lower the value, the more strict the limitation.

If you make a mistake

Press \leftarrow RETURN or \leftarrow to go back to the previous screen.

To turn off the Setup Display

Press DVD SETUP repeatedly until the Setup Display is turned off.

To turn off the Parental Control function and play the DVD after entering your password

Set [LEVEL] to [OFF] in Step 8.

To change the password

1 In Step 5, select [CHANGE PASSWORD \rightarrow] using \downarrow , then press ENTER or \rightarrow . The display for entering the password appears.

2 Follow Step 3 to enter a new password.

Playing the disc for which Parental Control is set

1 Insert the disc and press \triangleright .

The [PARENTAL CONTROL] display appears.

2 Enter your 4-digit password using the number buttons, then press ENTER.

The system starts playback.

Notes

- If you play a DVD which does not have the Parental Control function, playback cannot be limited on this system.
- Depending on the DVD, you may be asked to change the Parental Control level while playing the disc. In this case, enter your password, then change the level. If the Resume Play mode is cancelled, the level returns to the original level.

Tip

If you forget your password, remove the disc and repeat Step 1 to 3 of “Limiting playback for children.” When you are asked to enter your password, enter “199703” using the number buttons, then press ENTER. The display will ask you to enter a new 4-digit password. After you enter a new 4-digit password in Step 3, replace the disc in the system and press \triangleright . When the [PARENTAL CONTROL] display appears, enter your new password.

Area Code

Standard	Code number
Argentina	2044
Australia	2047
Austria	2046
Belgium	2057
Brazil	2070
Canada	2079
Chile	2090
China	2092
Denmark	2115
Finland	2165
France	2174
Germany	2109
Hong Kong	2219
India	2248
Indonesia	2238
Italy	2254
Japan	2276
Korea	2304
Malaysia	2363
Mexico	2362
Netherlands	2376
New Zealand	2390
Norway	2379
Pakistan	2427
Philippines	2424
Portugal	2436
Russia	2489
Singapore	2501
Spain	2149
Sweden	2499
Switzerland	2086
Taiwan	2543
Thailand	2528
United Kingdom	2184

Other Operations

Controlling TV with the Supplied Remote

By adjusting the remote signal, you can control your TV with the supplied remote.

Notes

- If you enter a new code number, the code number previously entered will be erased.
- When you replace the batteries of the remote, the code number may reset itself to the default (SONY) setting. Reset the appropriate code number.

Controlling TVs with the remote

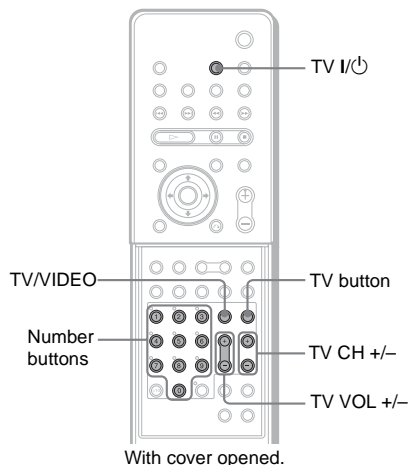

Press and hold TV I/O while entering your TV's manufacturer's code (see the table) using the number buttons. Then release TV I/O.

If you set successfully the manufacturer's code, the TV button flashes twice slowly. If the setting is unsuccessful, the TV button flashes five times quickly.

Code numbers of controllable TVs

If more than one code number is listed, try entering them one at a time until you find the one that works with your TV.

TV

Manufacturer	Code number
SONY	001
Admiral	012, 016, 039
AIWA	001, 007, 008
AKAI	002, 010, 027
AOC	002
Bell&Howell	016, 039
Bestar	027
Blaupunkt	052, 053
Blue sky	027
Brandt	045
Broksonic (Brocsonic)	002
Bush	006, 027
Clatronic	027
Croslex	034
CURTIS-MATHES	002, 046
DAEWOO	002, 003, 004, 005, 006, 027
Daytron	020
Deccacolour	037
DUAL	027
EMERSON	002, 020
Ferguson	035, 042, 045
First line	010, 027
FISHER	009, 010
FUJITSU	055
FUNAI	054
Fraba	027
General Electric	002, 012, 049
Goodmans	006, 027, 045
GRUNDIG	038, 052, 053
HITACHI	002, 013, 014, 015, 020, 021, 027
Inno-Hit	027
Irradio	027
ITT/NOKIA	025, 026
JC Penny	002, 012
JVC	018, 019
Kendo	027

Manufacturer	Code number
Kiton	027
KTV	002, 020
LG/Goldstar	002, 020, 027, 028, 038
LOEWE	027, 028, 038
LXI(Sears)	002, 009, 012, 034, 046
MAGNAVOX	002, 020, 027, 034
MARANTZ	022
Mark	027
Matsui	010, 052, 053
Medion	027
Mitsubishi/MGA	002, 021, 022
NEC	002, 020, 023, 024, 048
NEI	027
NOKIA	025, 026
Nokia Oceanic	026
Nordmende	035, 042
Okano	027
ORION	007
PANASONIC	049, 050, 051
Philco	002, 004, 015, 020, 034
PHILIPS	013, 027, 034
Phoenix	027
PIONEER	029, 030, 031, 046, 049
Portland	002
Provision	027
PYE	027
QUASAR	039, 049
Radio	027
RADIO SHACK	002, 012, 022
Radiola	034
RCA/PROSCAN	002, 012, 032, 033
SABA	035, 041, 042, 043, 045
SAMSUNG	002, 013, 020, 027, 028, 036, 037, 038
SANYO	009, 010, 011
Schneider	027
SCOTT	002
SHARP	020, 039, 040
SIEMENS	052
Signature	016, 039, 040
Sinudyne	027
Supertech	027
Supervision	027

Manufacturer	Code number
SYLVANIA	002, 034
TaTung	027
TEAC	027
Techimagen	027
TELEFUNKEN	035, 041, 042, 043, 044, 045
THOMSON	035, 041, 043, 045
Thorn	027
TOSHIBA	039, 046, 047, 048
Universum	027
Vestel	027
Videch	002, 015
W.W.House	027
WARDS	002, 020
Watson	027
ZENITH	016, 017

Controlling the TV

You can control your TV using the buttons below.

By pressing	You can
TV I/⏻	Turn the TV on or off.
TV/VIDEO	Switch the TV's input source between the TV and other input sources.
TV VOL +/-	Adjust the TV volume.
TV CH +/-	Select the TV channel.

Using the number buttons for controlling the TV

When you set the remote to the TV mode, you can use the number buttons for controlling the TV.

Press the TV button.

The TV button turns red and the remote is set to the TV mode. You can select the TV channels by using the number buttons.

>10 is for selecting the channel number greater than 10.

To cancel the TV mode, press the TV button again.

Notes

- Depending on the TV, you may not be able to control your TV or to use some of the buttons above.
- The TV button turns off when you do not operate the remote for 10 seconds.

Tip

Depending on the TV manufacture, the following method also works. Press >10, then the number. (For example, for channel 25, press >10, then 2 and 5.)

Using the SONY TV DIRECT Function

SONY TV DIRECT allows you to turn on your SONY TV and this system, change the system mode to "DVD," and then switch the TV's input source you set with one button push.

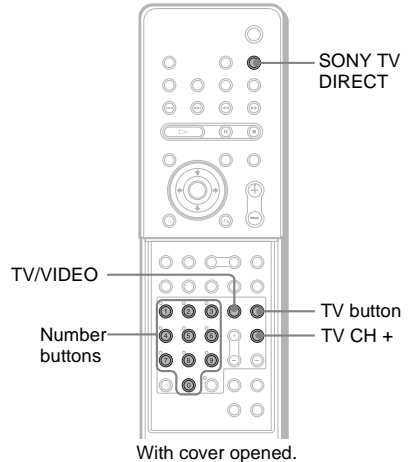

When you connect the  EURO AV OUPUT jack of the system to the EURO AV INPUT jack of your TV using the SCART (EURO AV) cord (not supplied), you do not need to perform the following preparation.

Preparation

Register the TV's input source connected to this system.

Press and hold TV/VIDEO while entering the code for the TV's input source to connect this system (see table below) using the number buttons.

TV's input source is selected.

If you successfully set the TV's input source code, the TV button flashes twice slowly. If the setting is unsuccessful, the TV button flashes five times quickly.

By pressing	Number	TV's input source
TV/VIDEO	0	No input source (Default)
	1	VIDEO1
	2	VIDEO2
	3	VIDEO3
	4	VIDEO4
	5	VIDEO5
	6	VIDEO6
	7*	COMPONENT1 INPUT
	8*	COMPONENT2 INPUT

* Except for North American models.

Operation

Point the remote to the direction of TV and this system, then press SONY TV DIRECT once.

While transmitting the code from the remote, the TV button flashes.

If this function does not work, change the transmit time. The transmit time varies depending on the TV.

To change the transmit time

Press and hold TV CH + while entering the code for transmit time (see table below) using the number buttons.

The transmit time from the remote is selected. If you successfully set the transmit time code, the TV button flashes twice slowly. If the setting is unsuccessful, the TV button flashes five times quickly.

By pressing	Number	Transmit time
TV CH+	1	0.5 (Default)
	2	1
	3	1.5
	4	2
	5	2.5
	6	3
	7	3.5
	8	4

Notes

- This function is only for SONY TV series.
- If distance between TV and this system is too far, this function may not work. Install the system near the TV.
- Keep the remote pointed in the direction of the TV and this system while the TV button is flashing.

Using the Video or Other Units

You can use VCRs or other units connected to the VIDEO or SAT jacks. Refer to the operation manual supplied with the unit for further information on the operation.

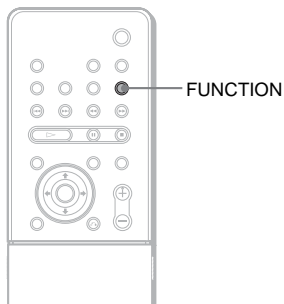

Press FUNCTION repeatedly until VIDEO or SAT that you connected the unit to appears in the front panel display.

Each time you press FUNCTION, the mode of the system changes in the following sequence.
FM → AM → VIDEO → SAT → TV* → DVD → FM...

* When selecting the TV, TV sound is output. When connecting to TV only using the SCART jack, no sound is output from TV.

Enjoying Multiplex Broadcast Sound (DUAL MONO)

You can enjoy multiplex broadcast sound when the system receive the AC-3 multiplex broadcast signal.

Note

To receive the AC-3 signal, you need to connect a digital satellite tuner to the system with an OPTICAL cable (page 22) and set the digital output mode of the digital satellite tuner to AAC.

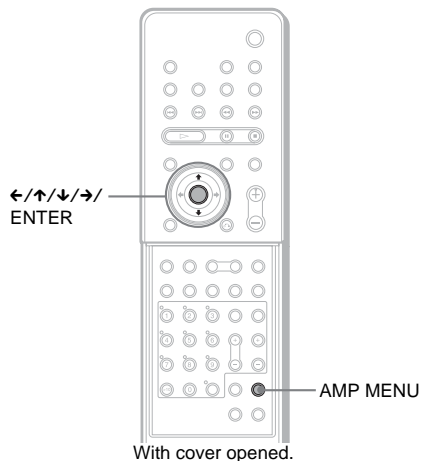

- 1 Press AMP MENU.**
- 2 Press ↓/↑ repeatedly until “CUSTOMIZE” appears in the front panel display, then press ENTER or →.**
The system enters the Customize Menu mode.
- 3 Press ↓/↑ repeatedly until “DUAL MONO” appears in the front panel display, then press ENTER or →.**
- 4 Press ↓/↑ to select the sound you want.**

■ MAIN

Main sound is output from the left and right speakers.

■ **SUB**

Sub sound is output from the left and right speakers.

■ **MAIN+SUB**

Main sound and Sub sound are output from the left and right speakers.

■ **MAIN/SUB**

Main sound is output from the left speaker and Sub sound is output from the right speaker.

5 Press AMP MENU.

Turns off the AMP menu.

Enjoying the Radio

Presetting Radio Stations

You can preset 20 FM stations, and 10 AM stations. Before tuning, make sure to turn down the volume to minimum.

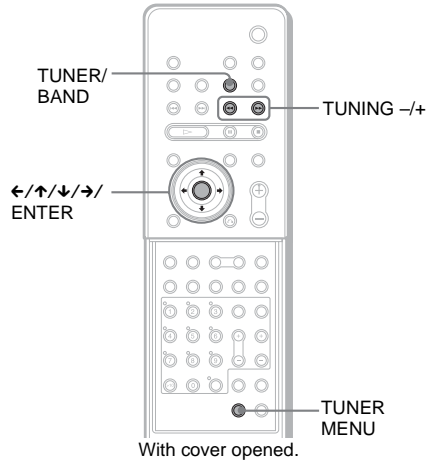

- 1 Press TUNER/BAND repeatedly until the band you want appears in the front panel display.**

Each time you press TUNER/BAND, the band toggles between AM and FM.

- 2 Press and hold TUNING + or – until scanning starts, then release.**

Scanning stops when the system tunes in a station. “TUNED” and “ST” (for stereo program) appear in the front panel display.



- 3 Press TUNER MENU.**

- 4 Press </>/M/</>/</> repeatedly until “MEMORY ?” appears in the front panel display.**

5 Press ENTER.

A preset number appears in the front panel display.



6 Press ←/→/↓/↑ to select/ the preset number you want.



7 Press ENTER.

The station is stored.



8 Repeat 1 to 7 to store other stations.

To change the preset number

Restart from step 1.

Listening to the Radio

Preset radio stations in the system's memory first (see "Presetting Radio Stations" on page 73).

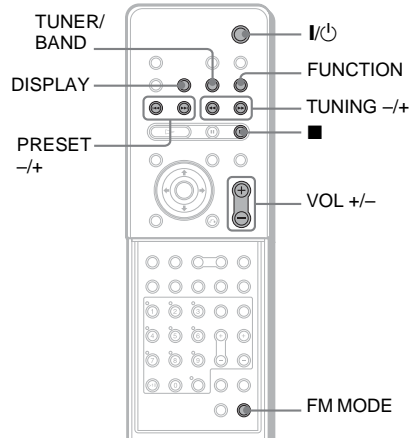

With cover opened.

1 Press FUNCTION repeatedly until "FM" or "AM" appears in the front panel display.

The last received station is tuned in.



2 Press PRESET + or - repeatedly to select the preset station you want.

Each time you press the button, the system tunes in one preset station.

Each time you press TUNER/BAND, the band toggles between AM and FM.

3 Adjust the volume by pressing VOL +/-.

To turn off the radio

Press I/⏻.

To listen to non-preset radio stations

Use manual or automatic tuning in Step 2.

For manual tuning, press TUNING + or – on the remote repeatedly.

For automatic tuning, press and hold TUNING + or – on the remote. Press ■ when you stop the automatic tuning.

Tips

- If an FM program is noisy, press FM MODE on the remote so that “MONO” appears in the front panel display. There will be no stereo effect, but the reception will improve. Press the button again to restore the stereo effect.
- To improve reception, reorient the supplied antennas (aerials).

To check the frequency or sound field

Press DISPLAY repeatedly.

Each time you press DISPLAY, the front panel display changes as follows:

index name of the station* → frequency → sound field → index name of the station...

* This is displayed if you have entered a name for a preset station (page 75).

Naming Preset Stations

You can enter a name of up to 8 characters for preset stations. These names (for example, “XYZ”) appear in the system’s front panel display when a station is selected.

Note that no more than one name can be entered for each preset station.

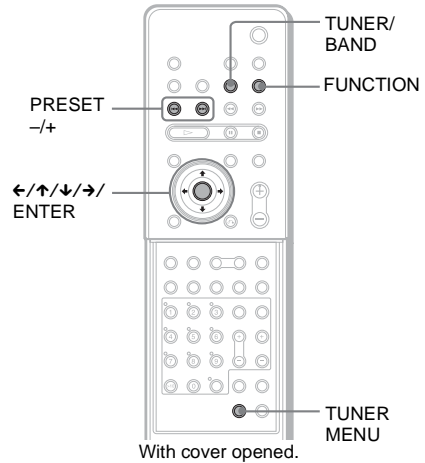

1 Press FUNCTION repeatedly until “FM” or “AM” appears in the front panel display.

Each time you press TUNER/BAND, the band toggles between AM and FM.

The last station you received is tuned in.

Each time you press FUNCTION, the mode of the system changes in the following sequence:

FM → AM → VIDEO → SAT → TV → DVD → FM...

2 Press PRESET+ or – repeatedly to select the preset station you want to create an index name for.

3 Press TUNER MENU.

4 Press ←/→ repeatedly until “NAME IN?” appears in the front panel display.

5 Press ENTER.

6 Create an index name by using the cursor buttons:

Press **↑/↓** to select a character, then press **→** to move the cursor to the next position.

If you make a mistake

Press **←/→** repeatedly until the character to be changed flashes, then press **↑/↓** to select the desired character. Capital letters, numbers, and other symbols can be input for a radio station name.

7 Press ENTER.

The station name is stored.

Using the Radio Data System (RDS)

What is the Radio Data System?

The Radio Data System (RDS) is a broadcasting service that allows radio stations to send additional information along with the regular program signal. This tuner offers convenient RDS features, such as station name display. RDS is available only for FM stations.*

Note

RDS may not work properly if the station you are tuned to is not transmitting the RDS signal properly, or if the signal strength is weak.

* Not all FM stations provide RDS service, nor do they provide the same type of services. If you are not familiar with the RDS system, check with your local radio stations for details on RDS services in your area.

Receiving RDS broadcasts

Simply select a station from the FM band.

When you tune in a station that provides RDS services, the station name* appears in the TUNER information.

* If an RDS broadcast is not received, the station name may not appear in the display.

Using the Sleep Timer

You can set the system to turn off at a preset time, so you can fall asleep listening to music. You can preset the time in 10 minutes decrements.

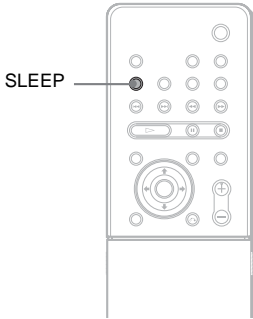

Press SLEEP.

Each time you press this button, the minutes display (the remaining time) changes as follows:

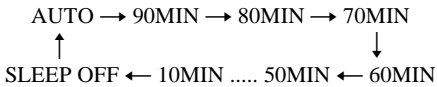

When you choose AUTO

The system turns off when the current disc finishes playback (up to 240 minutes). The system turns off if you manually stop playing a disc.

“AUTO” mode works only with functions such as DVD that is selected before setting to “AUTO.”

To check the remaining time

Press SLEEP once. You cannot check the remaining time if you select “AUTO.”

To change the remaining time

Press SLEEP repeatedly to select the desired time.

To cancel the Sleep Timer function

Press SLEEP repeatedly until “SLEEP OFF” appears in the front panel display.

Changing the Brightness of the Front Panel Display

You can change the brightness of the front panel display by two steps.

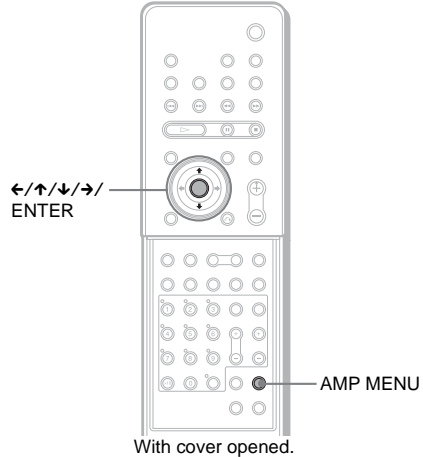

- 1 Press AMP MENU.**
- 2 Press ↓/↑ repeatedly until “CUSTOMIZE” appears in the front panel display, then press ENTER or →.**
The system enters the Customize Menu mode.
- 3 Press ↓/↑ repeatedly until “DIMMER” appears in the front panel display, then press ENTER or →.**
- 4 Press ↓/↑ to select the brightness of the front panel display.**
- 5 Press AMP MENU.**
Turns off the AMP menu.

Returning to the Default Settings

You can return the system parameters such as speaker settings and preset stations, to the default settings.

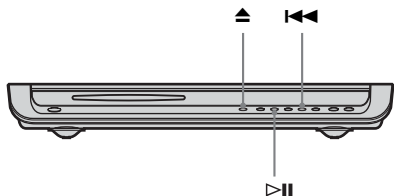

Press $\blacktriangleleft\blacktriangleleft$, $\triangleright\parallel$, or \blacktriangle , on the system at the same time.

“COLD RESET” appears in the front panel display and the default settings are returned.

Settings and Adjustments

Using the Setup Display



By using the Setup Display, you can make various adjustments to items, such as picture and sound. You can also set the subtitle language and the Setup Display, among other things. For details on each Setup Display item, see page 80-85. For an overall list of Setup Display items, see page 104.

How to use the Setup Display

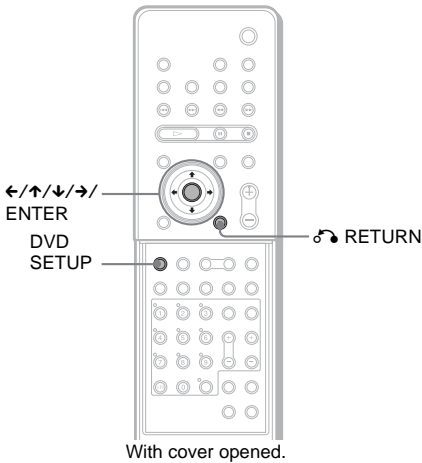

1 In stop mode, press DVD SETUP.

The Setup Display appears.

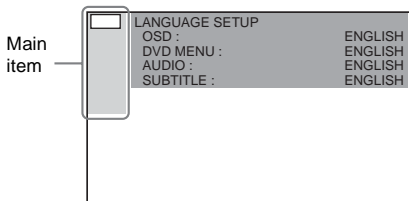

2 Press \uparrow/\downarrow to select the setup item from the displayed list: [LANGUAGE SETUP], [SCREEN SETUP], [CUSTOM SETUP], [SPEAKER SETUP], and [SETUP]. Then press ENTER or \rightarrow .

The selected Setup item appears.

Example: [SCREEN SETUP]

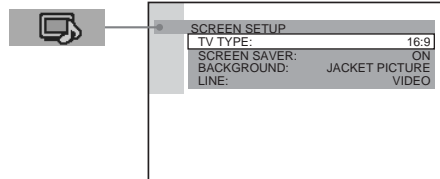

3 Select an item using \uparrow/\downarrow , then press ENTER or \rightarrow .

The options for the selected item appear.

Example: [TV TYPE]

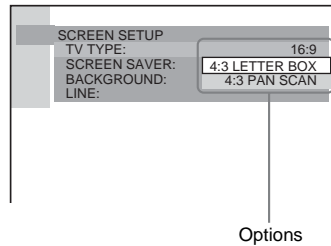

Press \leftarrow or RETURN to return to setup items.

4 Select a setting using \uparrow/\downarrow , then press ENTER.

The setting is selected and setup is complete.

Example: [4:3 PAN SCAN]

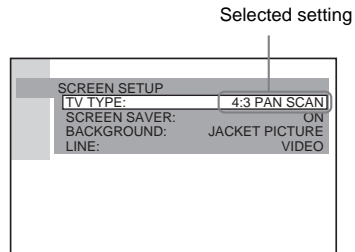

To turn off the Setup Display

Press DVD SETUP repeatedly until the Setup Display is turned off.

Setting the Display or Sound Track Language

[LANGUAGE SETUP]



[LANGUAGE SETUP] allows you to set various languages for the on-screen display or sound track.

Select [LANGUAGE SETUP] in the Setup Display. For details on using the display, see “Using the Setup Display” (page 79).

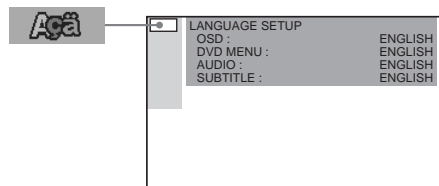

■ OSD (On-Screen Display)

Selects the display language on the screen. Select the language from the displayed list.

■ DVD MENU (DVD only)

Selects the desired language for the DVD menu. Select the language from the displayed list.

■ AUDIO (DVD only)

Selects the language of the sound track. Select the language from the displayed list.

■ SUBTITLE (DVD only)

Selects the language of the subtitle. Select the language from the displayed list.

Note

If you select a language that is not recorded on the DVD, one of the recorded languages will be automatically selected (except for [OSD]).

Tip

If you select [OTHERS →] in [DVD MENU], [AUDIO], or [SUBTITLE], select and enter the language code from the list using the number buttons (page 103).

After you have made a selection, the language code (4 digits) is displayed the next time you select [OTHERS →].

Settings for the Display

(SCREEN SETUP)



Choose settings according to the TV to be connected.

Select [SCREEN SETUP] in the Setup Display. For details on using the display, see “Using the Setup Display” (page 79).

The default settings are underlined.

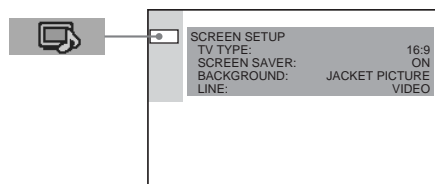

■ TV TYPE (DVD only)

Selects the aspect ratio of the connected TV (4:3 standard or wide).

16:9	Select this if you connect a wide-screen TV or a TV with a wide mode function.
4:3 LETTER BOX	Select this if you connect a 4:3 screen TV. Displays a wide picture with bands on the upper and lower portions of the screen.
4:3 PAN SCAN	Select this if you connect a 4:3 screen TV. Automatically displays the wide picture on the entire screen and cuts off the portions that do not fit.

16:9



4:3 LETTER BOX



4:3 PAN SCAN



Note

Depending on the DVD, [4:3 LETTER BOX] may be selected automatically instead of [4:3 PAN SCAN] or vice versa.

■ SCREEN SAVER

Turns the screen saver on and off so that the screen saver image appears when you leave the system in pause or stop mode for 15 minutes, or when you playback a CD, a Super Audio CD, an MP3, or JPEG file (except during the slide show) for more than 15 minutes. The screen saver will help prevent your display device from becoming damaged (afterimage). Press \triangleright to turn off the screen saver.

ON	Turns on the screen saver.
OFF	Turns off the screen saver.

■ BACKGROUND

Selects the background color or picture on the TV screen in stop mode or while playing a CD.

JACKET PICTURE	The jacket picture (still picture) appears in the background, but only if a jacket picture is already recorded on the disc (CD-EXTRA, etc.). If the disc does not contain a jacket picture, the [GRAPHICS 1] picture appears.
GRAPHICS 1-5	A preset picture stored in the system appears in the background.
BLUE	The background color is blue.
BLACK	The background color is black.

■ LINE

Selects the output method for video signals from the \hookrightarrow EURO AV OUTPUT (TO TV) jack on the rear panel of the system.

VIDEO	Outputs video signals.
RGB	Outputs RGB signals.

Note

If your TV does not accept RGB signals, no picture appears on the TV screen even if you select [RGB]. Refer to the instructions supplied with your TV.

Custom Settings

(CUSTOM SETUP)



Allows setting up Parental Control and other settings.

Select [CUSTOM SETUP] in the Setup Display. For details on using the display, see “Using the Setup Display” (page 79).

The default settings are underlined.

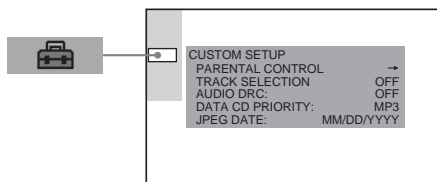

■ PARENTAL CONTROL → (DVD only)

Sets a password and playback limitation level for DVDs with playback limitation for children. For details, see “Limiting playback for children (Parental Control) (DVD only)” (page 65).

■ TRACK SELECTION (DVD only)

Gives the sound track having the highest number of channels priority when you play a DVD on which multiple audio formats (PCM, MPEG audio, DTS, or Dolby Digital format) are recorded.

<u>OFF</u>	No priority given.
<u>AUTO</u>	Priority given.

Notes

- When you set the item to [AUTO], the language may change. The [TRACK SELECTION] setting has higher priority than the [AUDIO] settings in [LANGUAGE SETUP] (page 80).
- If PCM, DTS, MPEG audio, and Dolby Digital sound tracks have the same number of channels, the system selects PCM, DTS, Dolby Digital, and MPEG audio sound tracks in this order.
- Depending on the DVD, the audio channel with priority may be predetermined. In this case, you cannot give priority to the DTS, Dolby Digital, or MPEG audio format by selecting [AUTO].

■ AUDIO DRC*

Narrows the DYNAMIC range of the sound track.

Useful for watching movies at low volume late at night.

* Dynamic Range Compression

<u>OFF</u>	No compression of DYNAMIC range.
<u>ON</u>	Reproduces the sound track with the kind of DYNAMIC range that the recording engineer intended.

Note

AUDIO DRC only applies to Dolby Digital sources.

■ DATA CD PRIORITY (MP3, JPEG only)

Set priority data you want to play, when you play a DATA CD (CD-ROM/CD-R/CD-RW) containing MP3 audio tracks and JPEG image files.

<u>MP3</u>	If an MP3 file exists on a disc, the system recognises the disc as an “MP3 Disc.” If only JPEG files exist on the disc, the system recognises the disc as a “JPEG Disc.”
------------	--------------------------------------------------------------------------------------------------------------------------------------------------------------------------

<u>JPEG</u>	If a JPEG file exists on the disc, the system recognises the disc as a “JPEG Disc.” If only MP3 files exist on the disc, the system recognises the disc as an “MP3 Disc.”
-------------	---------------------------------------------------------------------------------------------------------------------------------------------------------------------------

■ JPEG DATE

Change the date information order of a JPEG image in the Control Menu.

<u>MM/DD/YYYY</u>
<u>YYYY/MM/DD</u>
<u>DD/MM/YYYY</u>
<u>YYYY/DD/MM</u>

YYYY: Year

MM: Month

DD: Day

Settings for the Speakers

(SPEAKER SETUP)

To obtain the best possible surround sound, set for the size of the speakers you have connected and their distance from your listening position. Then use the test tone to adjust the level and the balance of the speakers to the same level.

Select [SPEAKER SETUP] in the Setup Display. For details, see “Using the Setup Display” (page 79).

The default settings are underlined.

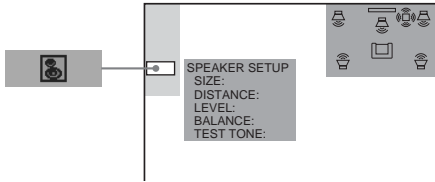

To return to the default setting when changing a setting

Select the item, then press CLEAR.

■ SIZE

If you do not connect center or surround speakers, or move the surround speakers, set the parameters for [CENTER] and [SURROUND] and specify the surround speaker position and height. Since the front speaker and subwoofer settings are fixed, you cannot change them. If you connect the surround back speaker, set [SURROUND BACK] to [YES].

Position diagram

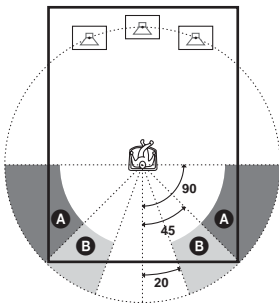

FRONT	<u>YES</u>
CENTER	<u>YES</u> : Normally select this. NONE: Select this if no center speaker is used.
SURROUND	BEHIND : Select this if surround speakers are located in section B . SIDE : Select this if surround speakers are located in section A . NONE: Select this if no surround speaker is used.
SURROUND BACK	<u>NONE</u> : Normally select this. YES: Select this if the surround back speaker is used.
SUBWOOFER	<u>YES</u>

Notes

- When you select an item, the sound cuts off for a moment.
- Depending on the settings of other speakers, subwoofer may be excessive.

■ DISTANCE

The default distance setting for the speakers in relation to the listening position is shown below. When you set the distance using the Quick Setup (page 30), the settings is automatically displayed.

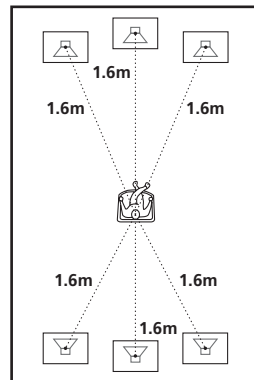

Be sure to change the value in the Setup Display when you move the speakers.

FRONT 1.6 m*	Front speaker distance from the listening position can be set in 0.2 meter increments from 1.0 to 7.0 meters.
CENTER 1.6 m* (appears when you set [CENTER] to [YES] in the [SIZE] setting.)	Center speaker distance can be moved up to 1.6 meters closer to the listening position from the front speaker distance, in 0.2 meter increments.
SURROUND 1.6 m* (appears except when you set [SURROUND] to [NONE] in the [SIZE] setting.)	Surround speaker distance can be moved up to 4.6 meters closer to the listening position from the front speaker distance, in 0.2 meter increments.
SURROUND BACK 1.6 m (appears when you set [SURROUND BACK] to [YES] in the [SIZE] setting.)	Surround back speaker distance can be moved up to 4.6 meters closer to the listening position from the front speaker distance, in 0.2 meter increments.

* When you perform the Quick Setup (page 30), the default settings are changed.

Notes

- When you set the distance, the sound cuts off for a moment.
- If all front and surround speakers are not placed at an equal distance from your listening position, set the distance according to the closest speaker.
- Do not place the surround speakers farther away from your listening position than the front speakers.
- Depending on the input stream, the [DISTANCE] setting may not be effective.

■ LEVEL

You can vary the level of each speaker as follows. Be sure to set [TEST TONE] to [ON] for easy adjustment.

CENTER 0 dB* (appears when you set [CENTER] to [YES] in the [SIZE] setting.)	Adjusts the level of the center speaker (–6 dB to +6 dB, 1 dB increments).
SURROUND LEFT 0 dB* SURROUND RIGHT 0 dB* (appears except when you set [SURROUND] to [NONE] in the [SIZE] setting.)	Adjusts the level of the surround speakers (–6 dB to +6 dB, 1 dB increments).
SURROUND BACK 0 dB (appears when you set [SURROUND BACK] to [YES] in the [SIZE] setting.)	Adjusts the level of the surround back speaker (–10 dB to +10 dB, 1 dB increments).
SUBWOOFER +4 dB*	Adjusts the level of the subwoofer (–6 dB to +6 dB, 1 dB increments).

* When you perform the Quick Setup (page 30), the default settings are changed.

■ BALANCE

You can vary the balance of the left and right speakers as follows. Be sure to set [TEST TONE] to [ON] for easy adjustment.

FRONT (CENTER)	Adjusts the balance between the front left and right speakers. The center position is shown as “---.” (You can adjust from the center 6 steps to left or right.)
-----------------------	---------------------------------------------------------------------------------------------------------------------------------------------------------------------

To adjust the volume of all the speakers at one time

Use the VOLUME control on the system, or press VOL +/-.

■ TEST TONE

The speakers will emit a test tone to adjust [LEVEL] and [BALANCE].

OFF	The test tone is not emitted from the speakers.
ON	The test tone is emitted from both left and right speakers simultaneously while adjusting balance. When you select one of the [SPEAKER SETUP] items, the test tone is emitted from each speaker in sequence.

Adjusting the speaker balance and level by using the test tone

- 1 Press DVD SETUP in stop mode.**
The Setup Display appears.
- 2 Press ↑/↓ repeatedly to select [SPEAKER SETUP], then press ENTER or →.**
- 3 Press ↑/↓ repeatedly to select [TEST TONE], then press ENTER or →.**
- 4 Press ↑/↓ repeatedly to select [ON], then press ENTER.**
You will hear the test tone from each speaker in sequence.
- 5 From your listening position, adjust the value of [BALANCE] and [LEVEL] using ←/↑/↓/→.**
When selecting [BALANCE], the test tone is emitted from both left and right speakers simultaneously.
When selecting [LEVEL], the test tone is emitted from only the speaker which you are adjusting.
- 6 Press ENTER when you have finished making adjustments.**
- 7 Press ↑/↓ repeatedly to select [TEST TONE], then press ENTER.**
- 8 Press ↑/↓ repeatedly to select [OFF], then press ENTER.**

Notes

- When you adjust the speaker settings, the sound cuts off for a moment.
- The surround back speaker level can be also adjusted on the amplifier that is connected to the surround back speaker.

Tip

To adjust the balance or the level without listening to the test tone, select [BALANCE] or [LEVEL] in step 3 and press ENTER. Then adjust the balance or level using ↑/↓ and press ENTER.

Setting the speakers by using the front panel display on the system

You can set the speakers by using the AMP menu that is displayed in the front panel display.

AMP menu list

SP SETUP

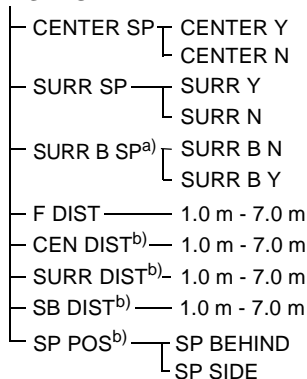

LEVEL



a) This setting appears when you set “SURR SP” to “SURR Y” in “SP SETUP.”

b) This setting appears when you set the corresponding speaker to “Y” in “SP SETUP.”

CUSTOMIZE

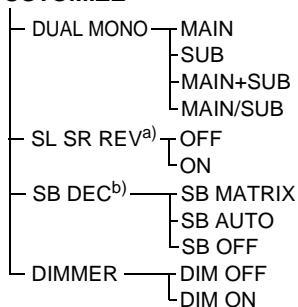

a) This setting appears when you set “SURR SP” to “SURR Y” in “SP SETUP.”

b) This setting appears when you set “SURR SP” to “SURR Y” and “SURR B SP” to “SURR B Y” in “SP SETUP.”

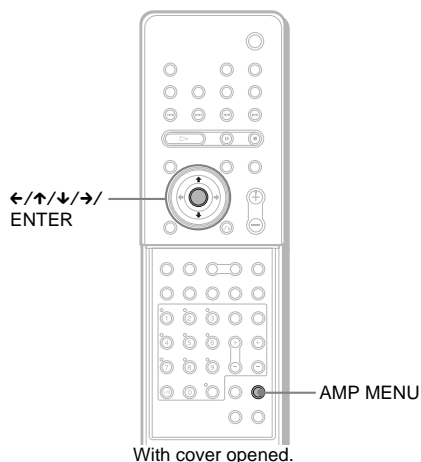

- 1 Press AMP MENU.**
- 2 Press ↑/↓ repeatedly until the item you want to set appears in the front panel display.**
 - **SP SETUP**
Sets the speaker size, distance, and place.
 - **LEVEL**
Sets the balance and level of the each speaker, and turns on/off the test tone.
- 3 Press ENTER or →.**
- 4 Press ↑/↓ to select the desired item, then press ENTER or →.**

To set the item, press **↑/↓**, then press **ENTER** or **AMP MENU**.

You can set the following items. The default settings are underlined.

■ SP SETUP

CENTER SP (center speaker)	<u>CENTER Y</u> : Select this if you use a center speaker. <u>CENTER N</u> : Select this if no center speaker is used.
SURR SP (surround speakers)	<u>SURR Y</u> : Select this if you use surround speakers. <u>SURR N</u> : Select this if no surround speaker is used.
SURR B SP^{a)} (surround back speaker)	<u>SURR B N</u> : Select this if no surround back speaker is used. <u>SURR B Y</u> : Select this if you use a surround back speaker.
F DIST (front distance) <u>1.6m^{b)}</u>	Front speaker distance from the listening position can be set in 0.2 meter increments from 1.0 to 7.0 meters.
CEN DIST^{c)} (center distance) <u>1.6m^{b)}</u>	Center speaker distance can be moved up to 1.6 meters closer to the listening position from the front speaker distance, in 0.2 meter increments.
SURR DIST^{c)} (surround distance) <u>1.6m^{b)}</u>	Surround speaker distance can be moved up to 4.6 meters closer to the listening position from the front speaker distance, in 0.2 meter increments.
SB DIST^{c)} (surround back distance) <u>1.6m^{b)}</u>	Surround back speaker distance can be moved up to 4.6 meters closer to the listening position from the front speaker distance, in 0.2 meter increments.
SP POS^{c)} (surround speakers position)	<u>SP BEHIND</u> : Select this if surround speakers are located in the back area of the listening position. <u>SP SIDE</u> : Select this if surround speakers are located in the side area of the listening position.

^{a)} This setting appears when you set “SURR SP” to “SURR Y” in “SP SETUP.”

- ^{b)} When you perform the Quick Setup (page 30), the default settings are changed.
^{c)} This setting appears when you set the corresponding speaker to “Y” in “SP SETUP” (page 87).

■ LEVEL

TEST TONE (test tone)	<u>T. TONE OFF</u> : The test tone is not emitted from the speakers. <u>T. TONE ON</u> : The test tone is emitted from both left and right speakers simultaneously while adjusting balance. When you select one of the “LEVEL” items, the test tone is emitted from each speaker in sequence.
F BALANCE (front balance) <u>0</u>	Adjusts the balance between the front left and right speakers. (You can adjust from the center 6 steps left (L6) or right (R6).)
CEN LEVEL^{b)} (center level) <u>0^{a)}</u>	Adjusts the level of the center speaker (–6 dB to +6 dB, 1 dB increments).
SL LEVEL^{b)} (surround left level) <u>0^{a)}</u>	Adjusts the left level of the surround speaker (–6 dB to +6 dB, 1 dB increments).
SR LEVEL^{b)} (surround right level) <u>0^{a)}</u>	Adjusts the right level of the surround speaker (–6 dB to +6 dB, 1 dB increments).
SB LEVEL^{b)} (surround back level) <u>0^{a)}</u>	Adjusts the level of the surround back speaker (–10 dB to +10 dB, 1 dB increments).
SW LEVEL (subwoofer level) <u>+4^{a)}</u>	Adjusts the level of the subwoofer (–6 dB to +6 dB, 1 dB increments).
AUDIO DRC (dynamic compression)	<u>DRC OFF</u> : No compression of DYNAMIC range. <u>DRC ON</u> : Reproduces the sound track with the kind of DYNAMIC range that the recording engineer intended.

- ^{a)} When you perform the Quick Setup (page 30), the default settings are changed.
^{b)} This setting appears when you set the corresponding speaker to “Y” in “SP SETUP” (page 87).

■ CUSTOMIZE

DUAL MONO (dual mono)	<u>MAIN</u>
	SUB
	MAIN+SUB
	MAIN/SUB
For details, see “Enjoying Multiplex Broadcast Sound (DUAL MONO)” on page 72.	
SL SR REV^{a)} (reverse the surround speaker position)	<u>OFF</u>
	ON
For details, see “When placing the surround speaker (L) in the (R) position” on page 24.	
SB DEC^{b)} (surround back decoding)	<u>SB MATRIX</u>
	SB AUTO
	SB OFF
	For details, see “Selecting the Surround Back Decoding Mode” on page 58.
DIMMER (dimmer)	<u>DIM OFF</u>
	DIM ON
For details, see “Changing the Brightness of the Front Panel Display” on page 77.	

a) This setting appears when you set “SURR SP” to “SURR Y” in “SP SETUP.”

b) This setting appears when you set “SURR SP” to “SURR Y” and “SURR B SP” to “SURR B Y” in “SP SETUP.”

Quick Setup and Resetting the System

(SETUP)

Select [SETUP] in the setup display.

For details, see “Using the Setup Display” (page 79).

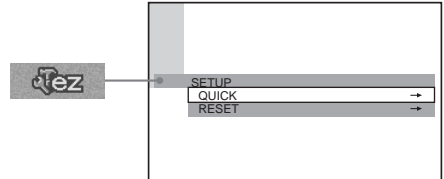

■ QUICK

Normally, when you turn the system on for the first time or after resetting the system, the guide message appears on the TV screen and you can perform the Quick Setup. If you cancelled the Quick Setup and you want to perform the Quick Setup again, operate on this screen.

See “How to use the Quick Setup” on page 30.

Note

After performing the Quick Setup, the settings of following items are changed.

- [OSD], [DVD MENU], and [SUBTITLE] in [LANGUAGE SETUP]
- [DISTANCE] and [LEVEL] in [SPEAKER SETUP]
- [TV TYPE] in [SCREEN SETUP]

■ RESET

You can reset the system.

After you select [RESET] and press ENTER, select [YES] to reset the settings (it takes a few seconds to complete). Select [NO] and press ENTER to cancel. Do not press I/O, when resetting the system.

Notes

- When you select [RESET], all the settings return to the default.
- When you turn the system on after resetting, the guide message appears on the TV screen. To perform the Quick Setup (page 30), press ENTER, to return to normal screen, press CLEAR.

Additional Information

Troubleshooting

If you experience any of the following difficulties while using the system, use this troubleshooting guide to help remedy the problem before requesting repairs. Should any problem persist, consult your nearest Sony dealer.

Power

The power is not turned on.

- Check that the AC power cord (mains lead) is connected securely.

The STANDBY indicator flashes.

Immediately unplug the power cord and check the following items.

- Are the + and – speaker cords short-circuited?
- Are you using only the specified speakers?
- Is anything blocking the ventilation holes on the top of the system?
- Is the subwoofer connected incorrectly?

After checking the above items and fixing any problems, connect the power cord again and turn on the system. If the indicator still flashes, or if the cause of the problem cannot be found even after checking all the above items, consult your nearest Sony dealer.

The POWER/ON LINE indicator does not turn on.

- The + and – speaker cords are short-circuited. In this case, disconnect the AC power cord (mains lead) of the surround speaker (L) from the wall outlet (mains), reconnect, and then turn the surround speaker (L) on.

Picture

There is no picture.

- The SCART (EURO AV) cord is not connected securely.
- The SCART (EURO AV) cord is damaged.
- The system is not connected to the correct Ⓢ EURO AV INPUT jack (page 21).
- The video input on the TV is not set so that you can view pictures from the system.
- Check the output method on your system (page 81).

Picture noise appears.

- The disc is dirty or flawed.

Even though you set the aspect ratio in [TV TYPE] of [SCREEN SETUP], the picture does not fill the screen.

- The aspect ratio on the disc is fixed.

Sound

There is no sound.

- The speaker cord is not connected securely.
- Press MUTING on the remote if “MUTING ON” is displayed in the front panel display.
- The system is in pause mode or in Slow-motion Play mode. Press ▷ to return to normal play mode.
- Fast forward or fast reverse is performed. Press ▷ to return to normal play mode.
- Check the speaker settings (pages 32, 83).

The left and right sounds are unbalanced or reversed.

- Check that the speakers and components are connected correctly and securely.
- Adjust the balance parameter in the [BALANCE] menu (page 85).
- Make sure the SL SR REV setting in the AMP menu is appropriate (page 24).

There is no sound from the subwoofer.

- Check the speaker connections and settings (pages 32, 83).
- Set the sound field to “AUTO FORMAT DIRECT AUTO” (page 54).

Severe hum or noise is heard.

- Check that the speakers and components are connected securely.
- Check that the connecting cords are away from a transformer or motor, and at least 3 meters away from your TV set or a fluorescent light.
- Move your TV away from the audio components.
- The plugs and jacks are dirty. Wipe them with a cloth slightly moistened with alcohol.
- Clean the disc.

The sound loses stereo effect when you play a VIDEO CD, a CD, or an MP3.

- Set [AUDIO] to [STEREO] in the Control Menu display (page 52).
- Make sure the system is connected appropriately.

The surround effect is difficult to hear when you are playing a Dolby Digital, DTS, or MPEG audio sound track.

- Make sure the sound field function is on (page 54).
- Check the speaker connections and settings (pages 32, 83).
- Depending on the DVD, the output signal may not be the entire 5.1 channel. It may be monaural or stereo even if the sound track is recorded in Dolby Digital or MPEG audio format.

The sound comes from the center speaker only.

- Depending on the disc, the sound may come from the center speaker only.

No sound is heard from the center speaker.

- Check the speaker connections and settings.
- Make sure the sound field function is on (page 54).
- Depending on the source, the effect of the center speaker may be less noticeable.

No sound or only a very low-level sound is heard from the surround speakers.

- Check the speaker connections and settings.
- Make sure the sound field function is on (page 54).
- Select a sound field containing the word "C. ST. EX" (page 56).
- Depending on the source, the effect of the surround speakers may be less noticeable.
- Wireless setting of the surround speaker is not correct (page 25).
- The plasma display may interfere with transmission, in which case, adjust the position of the IR transmitter and IR receiver of the surround speaker (L) (or IR receiver) (page 25).
- Do not install the surround speaker (L) (or IR receiver) in a place exposed to direct sunlight or strong light such as an incandescent lamp.
- Clean the surface of the IR transmitter and IR receiver of the surround speaker (L) (or IR receiver).

Operation

Radio stations cannot be tuned in.

- Check that the antennas (aerials) are connected securely. Adjust the antennas (aerials) or connect an external antenna (aerial) if necessary.
- The signal strength of the stations is too weak (when tuning in with automatic tuning). Use direct tuning.
- No stations have been preset or the preset stations have been cleared (when tuning by scanning preset stations). Preset the stations (page 73).
- Press DISPLAY so that the frequency appears in the display.

The remote does not function.

- There are obstacles between the remote and the system.
- The distance between the remote and the system is too far.
- The remote is not pointed at the remote sensor on the system.
- The batteries in the remote are weak.

The POWER/ON LINE indicator momentarily turns red.

- When playing an MP3 or DVD disc, or when changing a disc, the indicator momentarily turns red. This is not a malfunction.

The POWER/ON LINE indicator flashes in red.

- Move the wireless system away from any other nearby wireless system(s).
- Point the IR transmitter at the IR receiver of the surround speaker (L) (or IR receiver).

The disc does not play.

- There is no disc inserted.
- The disc is upside down.
Insert the disc with the playback side facing down on the disc tray.
- The disc is skewed in the system.
- The system cannot play CD-ROMs, etc. (page 7).
- The region code on the DVD does not match the system.
- Moisture has condensed inside the system.
Remove the disc and leave the system turned on for about half an hour (page 2).

The MP3 audio track cannot be played.

- The DATA CD is not recorded in an MP3 format that conforms to ISO9660 Level 1/ Level 2 or Joliet.
- The MP3 audio track does not have the extension “.MP3.”
- The data is not formatted in MP3 even though it has the extension “.MP3.”
- The system can only play MP3 (MPEG1 Audio Layer3) audio.
- Set [DATA CD PRIORITY] to [MP3] in the [CUSTOM SETUP] setting (page 82).
- Directory level is more than 8.
- The disc contains more than 99 albums (the maximum number of MP3 audio tracks that can be contained on an album is 250).

The title of the MP3 audio album or track is not correctly displayed.

- The system can only display alphabetical letters and numbers. Other characters are displayed as “ ”.

The display for entering the password does not appear for Super Audio CD, even though Custom Parental Control is set.

- Custom Parental Control is set for different layers of a Super Audio CD.

The JPEG image file cannot be played.

- The DATA CD is not recorded in a JPEG format that conforms to ISO9660 Level 1/ Level 2 or Joliet.
- The JPEG image file does not have the extension “.JPG” or “.JPEG.”
- The data is not formatted in JPEG even though it has the extension “.JPG” or “.JPEG.”
- Image length or width is more than 4720 dots.
- Set [DATA CD PRIORITY] to [JPEG] in the [CUSTOM SETUP] setting (page 82).
- Directory level is more than 8.
- You cannot play the Progressive JPEG files.
- A JPEG image file with a high width to length ratio cannot be played.
- The disc contains more than 99 albums (the maximum number of JPEG image files that can be contained on an album is 250).

The title of the JPEG album or file is not correctly displayed.

- The system can only display alphabetical letters and numbers. Other characters are displayed as “ ”.

A disc does not start playing from the beginning.

- Program Play, Shuffle Play, or Repeat Play has been selected (pages 41, 43, 44).
- Resume Play has been selected.
During stop, press ■ on the system or the remote and then start playback (page 35).
- The title, DVD or PBC menu automatically appears on the TV screen.

The system starts playing the disc automatically.

- The DVD features an auto playback function.

Playback stops automatically.

- Some discs may contain an auto pause signal. While playing such a disc, the system stops playback at the auto pause signal.

The system turns off during DVD playback.

- If approximately one hour passes with DVD playback paused or with the DVD top menu or a DVD menu displayed during DVD playback, the system automatically turns off.

You cannot perform some functions such as Stop, Search, Slow-motion Play, Repeat Play, Shuffle Play, or Program Play.

- Depending on the disc, you may not be able to perform some of the operations above. See the operating manual that came with the disc.

Messages do not appear on the screen in the language you want.

- In the Setup Display, select the desired language for the on-screen display in [OSD] under [LANGUAGE SETUP] (page 80).

The language for the sound track cannot be changed.

- Multilingual tracks are not recorded on the DVD being played.
- The DVD prohibits changing the language for the sound track.

The subtitle language cannot be changed.

- Multilingual subtitles are not recorded on the DVD being played.
- The DVD prohibits changing the subtitles.

The subtitle cannot be turned off.

- The DVD prohibits turning off subtitles.

The angles cannot be changed.

- Multi-angles are not recorded on the DVD being played (page 61).
- The DVD prohibits changing the angles.

A disc cannot be ejected and “LOCKED” appears in the front panel display.

- Contact your Sony dealer or local authorized Sony service facility.

“C-32” appears in the front panel display.

- Turn the power off and then on again by pressing **I/⏻** on the system.

“CANNOT LOCK” appears in the front panel display.

- Turn the power off and then on again by pressing **I/⏻** on the system, then perform “On moving the system” (page 3). If “CANNOT LOCK” still appears in the front panel display, contact your Sony dealer or local authorized Sony service facility.

The system does not work normally.

- Disconnect the AC power cord (mains lead) from the wall outlet (mains), then reconnect after several minutes.

Specifications

Amplifier section

Stereo mode (rated)	65 W + 65 W (4 ohms at 1 kHz, DIN)
Surround mode (reference)	Front: 114 W + 114 W (with SS-TS21)
music power output	Center*: 114 W (with SS-CT33) Surround*: 114 W + 114 W (with SA-TS22W, SS-TS21) Subwoofer*: 115 W × 2 (with SS-WS12)

* Depending on the sound field settings and the source, there may be no sound output.

Inputs	VIDEO/TV/SAT: Sensitivity: 250 mV/ 450 mV/450 mV Impedance: 50 kilohms
Output	SURROUND BACK Voltage: 2V Impedance: 1 kilohms
Phones	Accepts low-and high-impedance headphones.

Super Audio CD/DVD system

Laser	Semiconductor laser (Super Audio CD/DVD: λ = 650 nm) (CD: λ = 780 nm) Emission duration: continuous
Signal format system	PAL/NTSC
Frequency response (at 2 CH STEREO mode)	DVD (PCM): 2 Hz to 22 kHz (± 1.0 dB) CD: 2 Hz to 20 kHz (± 1.0 dB)
Harmonic distortion	Less than 0.03 %

Tuner section

System	PLL quartz-locked digital synthesizer system
FM tuner section	
Tuning range	87.5 – 108.0 MHz (50 kHz step)
Antenna (aerial)	FM wire antenna (aerial)
Antenna (aerial) terminals	75 ohms, unbalanced
Intermediate frequency	10.7 MHz
AM tuner section	
Tuning range	531 – 1,602 kHz (with the interval set at 9 kHz)
Antenna (aerial)	AM loop antenna (aerial)
Intermediate frequency	450 kHz

Video section

Outputs	Video: 1 V _{p-p} 75 ohms
---------	-----------------------------------

Speakers

Front/Surround (R)

Speaker system	Two-way Bass reflex
Speaker unit	70 mm dia. cone type, 25 mm dia. balance-dome-type tweeter
Rated impedance	4 ohms
Dimensions (approx.)	255 × 1112 × 255 mm (w/h/d)
Mass (approx.)	4.1 kg

Center

Speaker system	Two-way Bass reflex
Speaker unit	70 mm dia. cone type, 25 mm dia. balance-dome-type tweeter
Rated impedance	4 ohms
Dimensions (approx.)	356 × 92 × 76 mm (w/h/d)
Mass (approx.)	0.95 kg

Surround (L)

Speaker system	Two-way Bass reflex
Speaker unit	70 mm dia. cone type, 25 mm dia. balance-dome-type tweeter
Rated impedance	4 ohms
Dimensions (approx.)	255 × 1112 × 255 mm (w/h/d)
Mass (approx.)	5.0 kg

Subwoofer

Speaker system	Bass reflex
Speaker unit	160 mm dia. cone type × 2
Rated impedance	4 ohms
Dimensions (approx.)	201 × 368 × 448 mm (w/h/d)
Mass (approx.)	9.5 kg

General System

Power requirements	220 – 240 V AC, 50/60 Hz
Power consumption	90 W 0.3 W (at the Power Saving mode)
Dimensions (approx.)	430 × 60 × 385 mm (w/h/d) incl. projecting parts
Mass (approx.)	4.7 kg

Surround speaker (L)

Power requirements	220-240 V AC, 50/60 Hz
Power consumption	36 W (220-240 V AC)

Supplied accessories	See page 11.
----------------------	--------------

Design and specifications are subject to change without notice.

Glossary

Album

Section of a music piece or an image on a data CD containing MP3 audio tracks or JPEG files.

Chapter

Subdivision of a title on a DVD. A title is composed of several chapters.

Digital Cinema Sound (DCS)

This is the generic name of the surround sound produced by digital signal processing technology developed by Sony. Unlike previous surround sound fields mainly directed at the reproduction of music, Digital Cinema Sound is designed specifically for the enjoyment of movies.

Digital Infrared Audio Transmission

Recent times have been witness to the rapid spread of DVDs, Digital Broadcasting Satellite Receiver and other high-quality media. In order to ensure that the subtle nuances endowed by these high-quality media would be transmitted with no accompanying deterioration, Sony developed a technology called "Digital Infrared Audio Transmission" for the infrared transmission of digital audio signals using no compression, and it introduced it into the DAV-SR4W.

This technology transfers digital audio signals using no compression inside the subcarrier frequency band allocated by the IEC (International Electronic Committee) and JEITA (Japan Electronics and Information Technology Industries Association) for hi-fi audio transmission applications. (See Fig. 1)

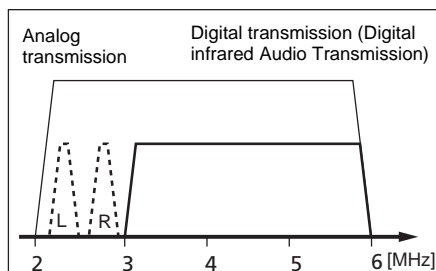

Fig. 1 Signal spectrum for digital infrared audio transmission

Dolby Digital

This movie theater sound format is more advanced than Dolby Surround Pro Logic. In this format, the surround speakers output stereo sound with an expanded frequency range, and a subwoofer channel for deep bass is independently provided. This format is also called "5.1," with the subwoofer channel designated as the 0.1 channel (since it functions only when a deep bass effect is needed). All six channels in this format are recorded separately for superior channel separation. Furthermore, since all the signals are processed digitally, less signal degradation occurs.

Dolby Digital EX

An enhanced compatible format of Dolby Digital 5.1, developed by Dolby Laboratories and Lucasfilm THX, which adds an extra surround back channel, and can be used for 6.1 (three surround speakers) channel playback, using matrix encoding.

Dolby Pro Logic II

Dolby Pro Logic II creates five full-bandwidth output channels from two-channel sources. This is done using an advanced, high-purity matrix surround decoder that extracts the spatial properties of the original recording without adding any new sounds or tonal colorations.

■ Movie mode

The Movie mode is for use with stereo television shows and all programs encoded in Dolby Surround. The result is enhanced sound field directionality that approaches the quality of discrete 5.1-channel sound.

■ Music mode

The Music mode is for use with any stereo music recordings, and provides a wide and deep sound space.

Dolby Surround Pro Logic

As one method of decoding Dolby Surround, Dolby Surround Pro Logic produces four channels from two-channel sound. Compared with the former Dolby Surround system, Dolby Surround Pro Logic reproduces left-to-right panning more naturally and localizes sounds more precisely. To take full advantage of Dolby Surround Pro Logic, you should have one pair of surround speakers and a center speaker. The surround speakers output monaural sound.

DTS

Digital audio compression technology developed by Digital Theater Systems, Inc. This technology conforms to 5.1-channel surround. This format comprises of stereo rear channels and a discrete subwoofer channel. DTS provides the same 5.1 discrete channels of high quality digital audio. The good channel separation is realized due to all channel data being recorded discretely and processed digitally.

DTS-ES

An enhanced compatible format of 5.1 channel, which adds an extra surround back channel. There are two formats: Discrete 6.1, which processes the surround back signal independently, and Matrix 6.1, which processes it along with the Surround (L/R) channels.

DVD

A disc that contains up to 8 hours of moving pictures even though its diameter is the same as a CD.

The data capacity of a single-layer and single-sided DVD, at 4.7 GB (Giga Byte), is 7 times that of a CD. Furthermore, the data capacity of a dual-layer and single-sided DVD is 8.5 GB, a single-layer and double-sided DVD 9.4 GB, and a dual-layer and double-sided DVD 17 GB. The picture data uses the MPEG 2 format, one of a worldwide standard of digital compression technology. The picture data is compressed to about 1/40 of its original size. DVD also uses variable rate coding technology that processes allocated data according to the status of the picture.

The audio data is recorded in Dolby Digital as well as in PCM, allowing you to enjoy more realistic audio presence.

Furthermore, various advanced functions such as the multi-angle, multilingual, and Parental Control functions are provided with the DVD.

File

Section of a picture on a data CD containing JPEG image files.

Film based software, Video based software

DVDs can be classified as Film based or Video based software. Film based DVDs contain the same images (24 frames per second) that are shown at movie theaters. Video based DVDs, such as television dramas or sit-coms, displays images at 30 frames (or 60 fields) per second.

Index (Super Audio CD, CD)/Video Index (VIDEO CD)

A number that divides a track into sections to easily locate the point you want on a VIDEO CD, Super Audio CD, or CD. Depending on the disc, no indexes may be recorded.

Multi-angle function

Various angles of a scene, or viewpoints of the video camera are recorded on some DVDs.

Multilingual function

Several languages for the sound or subtitles in a picture are recorded on some DVDs.

Neo:6

Developed by Digital Theater Systems, Inc., applies a conventional 2-channel or Dolby Digital source signal to a high-precision, digital matrix decoder to achieve 6.1 channel surround playback.

CINEMA mode allows for more separation of channels to enhance the 6.1 channel effect, and is best suited for movies.

MUSIC mode allows the front L and R channels to go unprocessed for optimum stereo, with the addition of the surround components adding a special quality to the sound.

Parental Control

A function of the DVD to limit playback of the disc by the age of the users according to the limitation level in each country. The limitation varies from disc to disc; when it is activated, playback is completely prohibited, violent scenes are skipped or replaced with other scenes and so on.

Playback Control (PBC)

Signals encoded on VIDEO CDs (Version 2.0) to control playback.

By using menu screens recorded on VIDEO CDs with PBC functions, you can enjoy playing simple interactive programs, programs with search functions, and so on.

Region Code

This system is used to protect copyrights. A region number is allocated on each DVD system or DVD disc according to the sales region. Each region code is shown on the system as well as on the disc packaging. The system can play the discs that match its region code. The system can also play discs with the “” mark. Even when the region code is not shown on the DVD, the region limit may still be activated.

Scene

On a VIDEO CD with PBC (playback control) functions, the menu screens, moving pictures and still pictures are divided into sections called “scenes.”

Super Audio CD

A Super Audio CD disc can reproduce sounds that are extremely faithful to the original sound by use of DSD (Direct Stream Digital) technology. This technology utilizes a sampling frequency of 2.8224 MHz, which is 64 times that of a conventional CD, and 1-bit quantization that enables the disc to hold 4 times the amount of information that a standard PCM format CD can hold. Super Audio CDs are divided into the following types.

- Super Audio CD (single layer disc)

This disc consists of a single HD layer*.

* High density signal layer for the Super Audio CD



- Super Audio CD (dual layer disc)
This disc consists of dual HD layers and is capable of extended play over long periods. Also, as the dual layer disc consists of dual HD layers on one side only, you do not have to turn the disc over during playback.

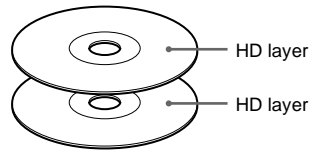

- Super Audio CD + CD (Hybrid disc)
This disc consists of an HD layer and a CD layer. Also, as the dual layers are on one side only, you do not have to turn the disc over during playback. You can play this CD layer using a conventional CD player.

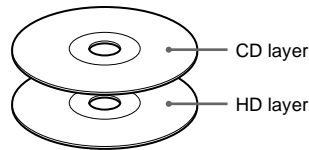

- 2 channel + Multi-channel Super Audio CD
This disc consists of a 2 channel playback area and a multi-channel playback area.

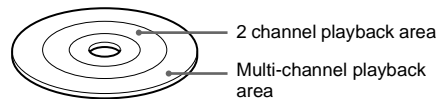

Title

The longest section of a picture or music feature on a DVD, movie, etc., in video software, or the entire album in audio software.

Track

Section of a picture or a music piece on a Super Audio CD, CD, VIDEO CD or MP3. An album is composed of several tracks (MP3 only).

VIDEO CD

A compact disc that contains moving pictures. The picture data uses the MPEG 1 format, one of a worldwide standard of digital compression technology. The picture data is compressed to about 1/140 of its original size. Consequently, a 12 cm VIDEO CD can contain up to 74 minutes of moving pictures.

VIDEO CDs also contain compact audio data. Sounds outside the range of human hearing are compressed while sounds we can hear are not compressed. VIDEO CDs can hold 6 times the audio information of conventional audio CDs. There are 2 versions of VIDEO CDs.

- Version 1.1: You can play only moving pictures and sounds.
- Version 2.0: You can play high-resolution still pictures and enjoy PBC functions.

This system conforms to both versions.

Index to Parts and Controls

For more information, refer to the pages indicated in parentheses.

Front Panel

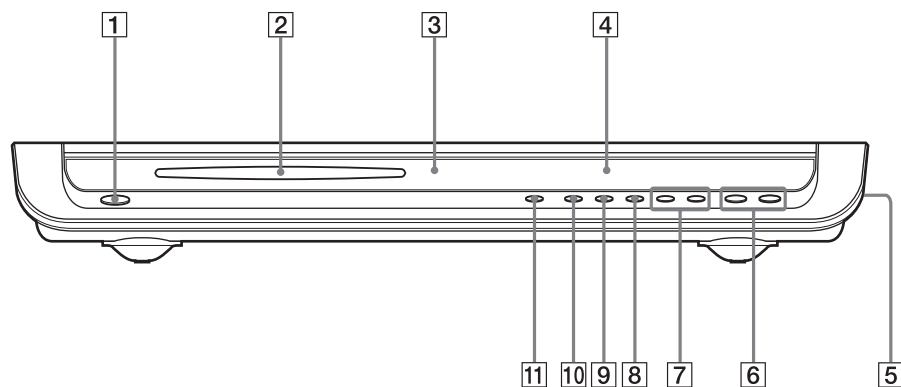

- 1** I/O (power) switch/STANDBY indicator (33)
- 2** Disc slot (33)
- 3** R (remote sensor) (11)
- 4** Front panel display (99)
- 5** PHONES (on the side of the system) jack (33)

- 6** VOLUME +/- (33, 85)
- 7** ◀▶ (34, 36)
- 8** ■ (stop) (34)
- 9** ▷|| (play/pause) (33)
- 10** FUNCTION (33, 72, 74)
- 11** ▲ (eject) (33)

Front Panel Display

When playing back a DVD

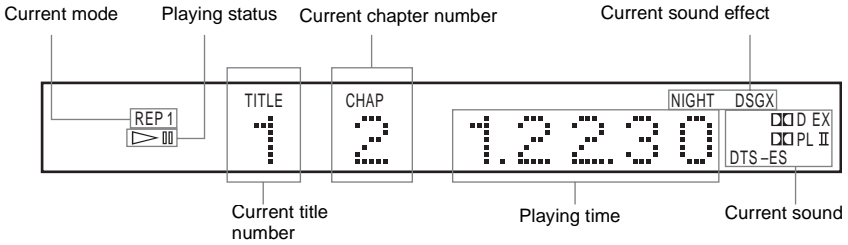

When playing back a Super Audio CD, CD, VIDEO CD (without PBC functions), or MP3

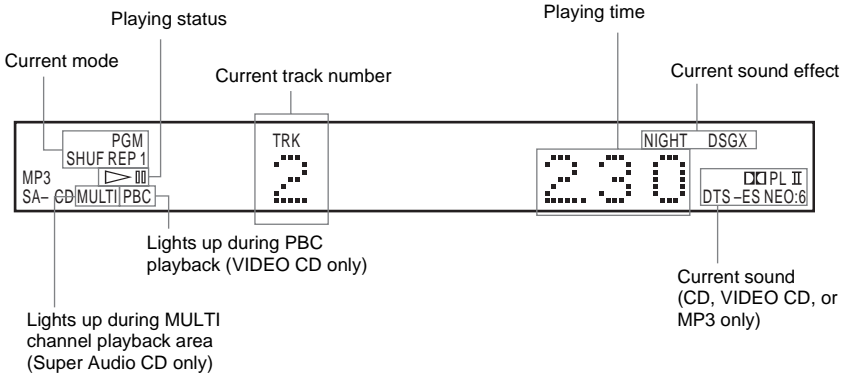

When listening to the radio

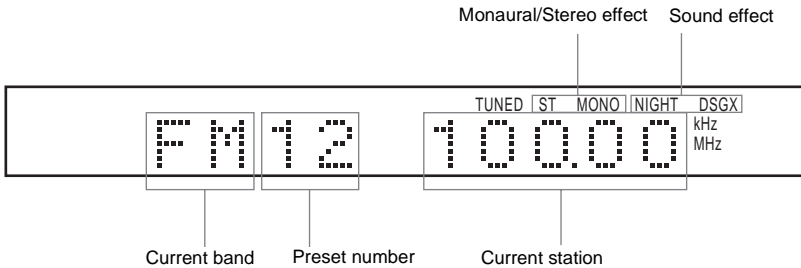

When playing back a JPEG file

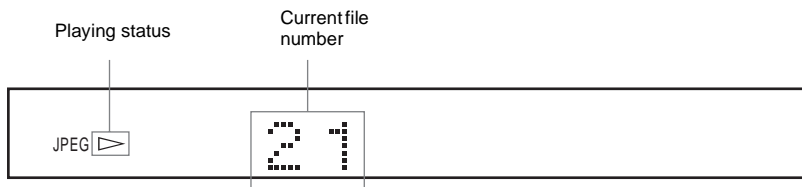

Rear Panel

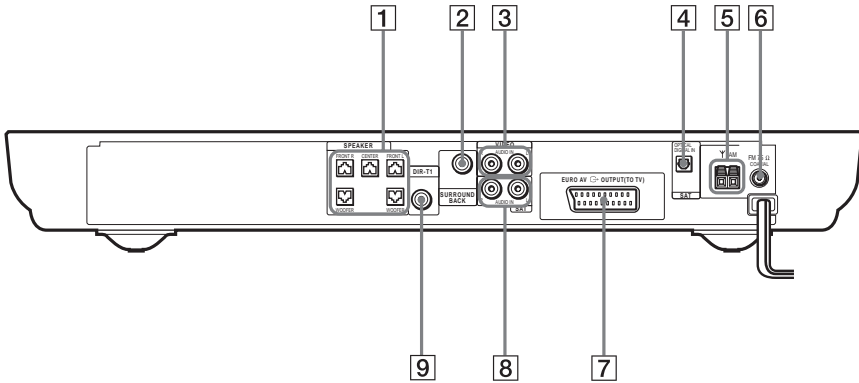

- | | | | |
|---|-----------------------------------------|---|------------------------------------------|
| 1 | SPEAKER jacks (14) | 6 | FM 75Ω COAXIAL jack (19) |
| 2 | SURROUND BACK jack (16) | 7 | EURO AV OUTPUT (TO TV) jacks (21) |
| 3 | VIDEO AUDIO IN (L/R) jacks (21) | 8 | SAT AUDIO IN (L/R) jacks (21) |
| 4 | SAT OPTICAL DIGITAL IN jack (22) | 9 | DIR-T1 jack (14) |
| 5 | AM terminals (19) | | |

Remote

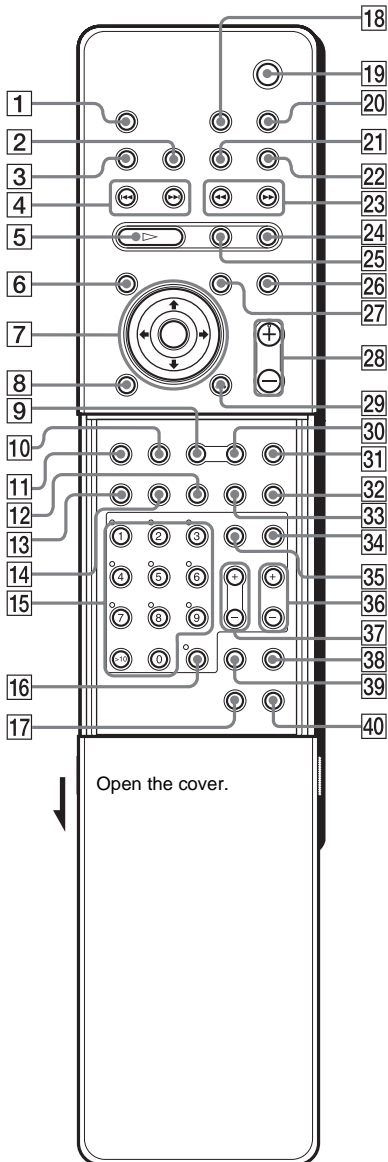

- 1 ▲ (eject) (33, 34)
- 2 DISPLAY (48, 50, 74)
- 3 SLEEP (77)
- 4 ◀◀/▶▶, PRESET -/+ (34, 36, 74, 75)
- 5 ▷ (play) (34, 35, 40, 41, 44, 45)
- 6 DVD TOP MENU/ALBUM- (36, 38, 39)
- 7 ◀/▶/◁/▷/ENTER (24, 30, 36, 36, 38, 39, 41, 41, 43, 44, 46, 52, 58, 61, 62, 63, 65, 73, 75, 77, 79, 86)
- 8 DVD DISPLAY (38, 39, 43, 44, 46, 50, 51, 52, 61, 62, 63)
- 9 AUTO FORMAT DIRECT (54, 55)
- 10 DSGX (60)
- 11 DVD SETUP (30, 65, 79)
- 12 SUBTITLE (62)
- 13 AUDIO (52)
- 14 ANGLE (61)
- 15 Number buttons (36, 36, 41, 46, 61, 63, 65, 68, 70)
- 16 ENTER
- 17 TUNER MENU (73, 75)
- 18 TV I/⏻ (on/standby) (68)
- 19 I/⏻ (standby) (30, 33, 73)
- 20 SONY TV DIRECT (70)
- 21 TUNER/BAND (73, 74, 75)
- 22 FUNCTION (33, 72, 74, 75)
- 23 ◀◀/▶▶/◁/▷ SLOW, TUNING -/+ (40, 45, 73, 74)
- 24 ■ (stop) (34, 35, 36, 63, 74)
- 25 || (pause) (34)
- 26 MUTING (34)
- 27 DVD MENU/ALBUM+ (36, 38, 39)
- 28 VOL +/- (34, 74)
- 29 ↶ RETURN (36, 38, 39, 41, 46, 63, 65, 79)
- 30 MODE (55, 56)
- 31 NIGHT MODE (60)
- 32 PLAY MODE (41, 43)
- 33 REPEAT (41, 44)
- 34 TV (68, 70)
- 35 TV/VIDEO (68, 70)
- 36 TV CH +/- (68, 70)
- 37 TV VOL +/- (68)
- 38 AMP MENU (24, 58, 77, 86)
- 39 CLEAR (30, 41, 46)
- 40 FM MODE (74)

Note

This remote control glows in the dark. However, before glowing, the remote must be exposed to light for awhile.

Language Code List

The language spellings conform to the ISO 639: 1988 (E/F) standard.

Code	Language	Code	Language	Code	Language
1027	Afar	1245	Inupiak	1489	Russian
1028	Abkhazian	1248	Indonesian	1491	Kinyarwanda
1032	Afrikaans	1253	Icelandic	1495	Sanskrit
1039	Amharic	1254	Italian	1498	Sindhi
1044	Arabic	1257	Hebrew	1501	Sangho
1045	Assamese	1261	Japanese	1502	Serbo-Croatian
1051	Aymara	1269	Yiddish	1503	Singhalese
1052	Azerbaijani	1283	Javanese	1505	Slovak
1053	Bashkir	1287	Georgian	1506	Slovenian
1057	Byelorussian	1297	Kazakh	1507	Samoan
1059	Bulgarian	1298	Greenlandic	1508	Shona
1060	Bihari	1299	Cambodian	1509	Somali
1061	Bislama	1300	Kannada	1511	Albanian
1066	Bengali; Bangla	1301	Korean	1512	Serbian
1067	Tibetan	1305	Kashmiri	1513	Siswati
1070	Breton	1307	Kurdish	1514	Sesotho
1079	Catalan	1311	Kirghiz	1515	Sundanese
1093	Corsican	1313	Latin	1516	Swedish
1097	Czech	1326	Lingala	1517	Swahili
1103	Welsh	1327	Laothian	1521	Tamil
1105	Danish	1332	Lithuanian	1525	Telugu
1109	German	1334	Latvian; Lettish	1527	Tajik
1130	Bhutani	1345	Malagasy	1528	Thai
1142	Greek	1347	Maori	1529	Tigrinya
1144	English	1349	Macedonian	1531	Turkmen
1145	Esperanto	1350	Malayalam	1532	Tagalog
1149	Spanish	1352	Mongolian	1534	Setswana
1150	Estonian	1353	Moldavian	1535	Tonga
1151	Basque	1356	Marathi	1538	Turkish
1157	Persian	1357	Malay	1539	Tsonga
1165	Finnish	1358	Maltese	1540	Tatar
1166	Fiji	1363	Burmese	1543	Twi
1171	Faroese	1365	Nauru	1557	Ukrainian
1174	French	1369	Nepali	1564	Urdu
1181	Frisian	1376	Dutch	1572	Uzbek
1183	Irish	1379	Norwegian	1581	Vietnamese
1186	Scots Gaelic	1393	Occitan	1587	Volapük
1194	Galician	1403	(Afan) Oromo	1613	Wolof
1196	Guarani	1408	Oriya	1632	Xhosa
1203	Gujarati	1417	Punjabi	1665	Yoruba
1209	Hausa	1428	Polish	1684	Chinese
1217	Hindi	1435	Pashto; Pushto	1697	Zulu
1226	Croatian	1436	Portuguese		
1229	Hungarian	1463	Quechua	1703	Not specified
1233	Armenian	1481	Rhaeto-Romance		
1235	Interlingua	1482	Kirundi		
1239	Interlingue	1483	Romanian		

DVD Setup Menu List

You can set the following items with the DVD Setup menu.

The order of the displayed items may be different from the actual display.

LANGUAGE SETUP

- OSD — (Selects the language you want to use from the displayed language list.)
- DVD MENU — (Selects the language you want to use from the displayed language list.)
- AUDIO — (Selects the language you want to use from the displayed language list.)
- SUBTITLE — (Selects the language you want to use from the displayed language list.)

SCREEN SETUP

- TV TYPE —
 - 16:9
 - 4:3 LETTER BOX
 - 4:3 PAN SCAN
- SCREEN SAVER —
 - ON
 - OFF
- BACKGROUND —
 - JACKET
 - PICTURE
 - GRAPHICS 1
 - GRAPHICS 2
 - GRAPHICS 3
 - GRAPHICS 4
 - GRAPHICS 5
 - BLUE
 - BLACK
- LINE —
 - VIDEO
 - RGB

CUSTOM SETUP

- PARENTAL CONTROL —
 - LEVEL —
 - 8.
 - 7. NC17
 - 6. R
 - 5.
 - 4. PG13
 - 3. PG
 - 2.
 - 1. G
 - STANDARD —
 - USA
 - OTHERS →
 - CHANGE PASSWORD
- TRACK SELECTION —
 - OFF
 - AUTO
- AUDIO DRC —
 - OFF
 - ON
- DATA CD PRIORITY —
 - MP3
 - JPEG
- JPEG DATE —
 - MM/DD/YYYY
 - YYYY/MM/DD
 - DD/MM/YYYY
 - YYYY/DD/MM

SPEAKER SETUP

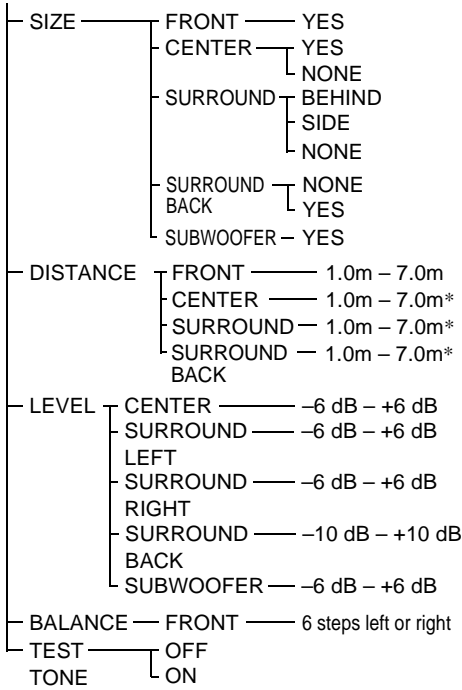

* The setting range changes depending on the front speaker setting (page 83).

SETUP

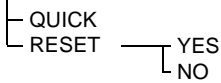

AMP Menu List

You can set the following items with AMP MENU on the remote.

SP SETUP

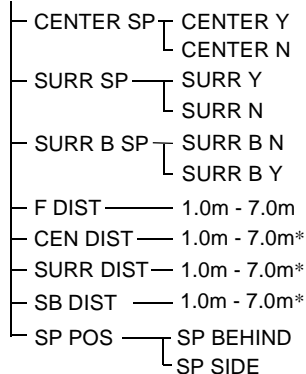

* The setting range changes depending on the front speaker setting (page 86).

CUSTOMIZE

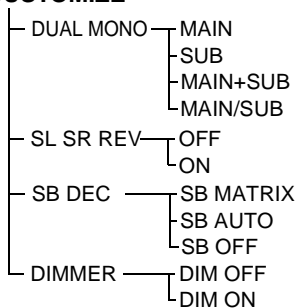

LEVEL

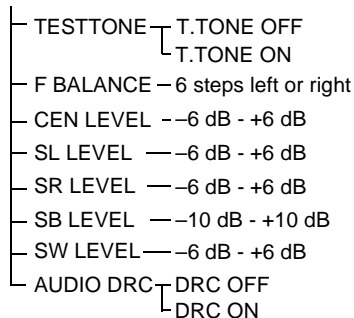

Index

Numerics

16:9 80
4:3 LETTER BOX 80
4:3 PAN SCAN 80

A

ALBUM 38, 46
Album 6, 94
ANGLE 61
Antenna (aerial) Hookups 19
AUDIO 52, 80
AUDIO DRC 82

B

BACKGROUND 81
BALANCE 85
Batteries 11

C

CHAPTER 47
Chapter 6, 94
Continuous play
 CD/VIDEO CD/Super Audio
 CD/DVD/MP3 33
Control Menu 9
CUSTOM PARENTAL
 CONTROL 63
CUSTOM SETUP 82

D

DATA CD PRIORITY 82
Digital Cinema Sound 94
Digital Infrared Audio
 Transmission 94
DIMMER 77
DISPLAY 48
DISTANCE 83
Dolby Digital 94
Dolby Digital EX 94
Dolby Pro Logic II 94
Dolby Surround Pro Logic 95
DSGX 60
DTS 95
DTS-ES 95
DUAL MONO 72
DVD 95
DVD MENU 80

F

Fast forward 45

Fast reverse 45
File 6, 95
Front Panel 98
Front panel display 99

H

Handling discs 8

I

INDEX 47
Index 6, 95

J

JPEG 39
JPEG DATE 82

L

LANGUAGE SETUP 80
LEVEL 84
LINE 81
Listening to the Radio 74

M

MP3 37
Multi-angle function 61, 95
Multilingual function 52, 95
MUTING 34

N

Neo:6 95
NIGHT MODE 60

O

On-screen display
 Control Menu display 9
OSD 80

P

PARENTAL CONTROL 65, 82,
 96
PBC Playback 36, 96
PLAY MODE 41, 43
Preset Station 73
Program Play 41

R

Radio 74
RDS 76
Rear Panel 101

Region Code 7, 96
Remote 68, 102
REPEAT 44
Resume Play 35

S

Scan 45
SCENE 9
Scene 6, 96
SCREEN SAVER 81
SCREEN SETUP 80
Setup Display 79
SHUFFLE 43
Shuffle Play 43
SIZE 83
SLEEP 77
Slide show 40
Slow-motion 45
Sound Field 54
SPEAKER SETUP 83
Speaker System Hookup 12
SUBTITLE 62, 80
Super Audio CD 96
Surround Back Decoding Mode
 58

T

TEST TONE 85
TIME SEARCH 46
TITLE 46
Title 6, 96
TRACK 46
Track 6, 38, 96
TRACK SELECTION 82
Troubleshooting 89
TV and Video Component
 Hookups 21
TV TYPE 80

U

Usable discs 6

V

VIDEO CD 97

W

Wireless system 18, 25

Quick Reference for Remote Commander

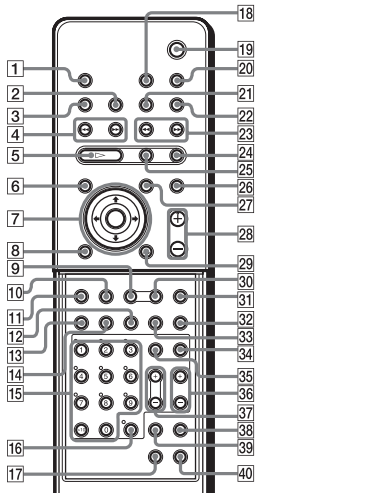

With cover opened.

Note

The remote control of the unit employs command signals in common with other Sony DVD products. Thus, depending on the button, other Sony DVD products may respond.

- 1** Ejects the disc.
- 2** Switches the item displayed on the front panel display.
- 3** Sets the system to turn off at a preset time.
- 4** **◀◀/▶▶**: Press to go to the next chapter or track or to go back to the previous chapter or track.
PRESET -/+: Scan all preset stations.
- 5** Plays a disc.
- 6** Displays the title menu on the TV screen.
MP3/JPEG: Selects albums.
- 7** Select and execute the items or settings.
- 8** Displays the Control Menu display on the TV screen to set or adjust the items.
- 9** Select the sound field.
- 10** Bass sound is effectively reinforced.
- 11** Displays the setup display on the TV screen to set or adjust the items.
- 12** Changes the subtitle.
- 13** Changes the sound.
- 14** Changes the angles when playing a DVD.
- 15** Select the items of settings. *TV: Select channel numbers.**
- 16** Executes the items or settings.
- 17** Press to store a preset station. Activates the name function.
- 18** Turns the TV on and off.

- 19** Turns on and off the power of the system.
- 20** Turns the SONY TV and the system on and changes the TV's input source.
- 21** Selects AM or FM band.
- 22** Selects the component you want to use.
- 23** **◀◀/▶▶** (SCAN): Locate a point while monitoring the picture while playing a disc.
◀/▶ SLOW: Play a disc in slow motion in the pause mode.
TUNING -/+ : Scan all available radio stations.
- 24** Stops playing a disc.
- 25** Pauses playing a disc.
- 26** Mutes the sound.
- 27** Displays the DVD menu on the TV screen.
MP3/JPEG: Selects albums.
- 28** Adjust the SYSTEM volume.
- 29** Press to return to the previously selected screen, etc.
- 30** Select the sound field.
- 31** Makes sound clear at low volume.
- 32** Selects program or shuffle play mode.
- 33** Displays the repeat status.
- 34** Sets the remote to TV mode.
Normal mode: tuns off.
TV mode: tuns in red.
- 35** Changes the input mode of the TV.
- 36** Select the TV Channel.
- 37** Adjust the TV volume.
- 38** Sets the speaker parameter and changes the brightness of the front panel display by two steps.
- 39** Press to cancel the programmed track, etc.
- 40** Switches monaural or stereo of FM stereo reception.

* Depending on the TV manufacture, the following method also works. Press >10, then the number. (For example, for channel 25, press >10, then 2 and 5.)