

IMPORTANT MANUAL Do Not Throw Away

WEED EATER

TRADEMARK ©

▲ DANGER: Read the Operator's Manual and Follow All Warnings and Safety Instructions. Failure To Do So Can Result in Serious Injury.

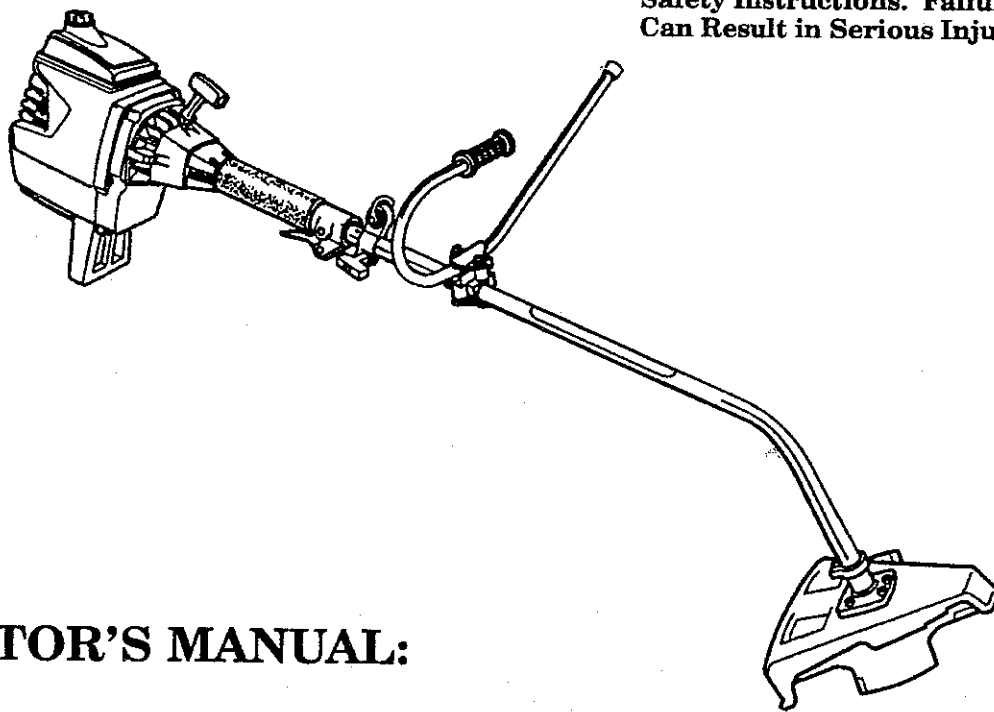

OPERATOR'S MANUAL:

MODEL:

XT™ 85T

GAS POWERED TRIMMER (18")

Always Wear Eye Protection

**CUSTOMER
ASSISTANCE**

1-800-554-6723

SEE BACK COVER FOR DETAILS!

TABLE OF CONTENTS

WARNINGS AND SAFETY INSTRUCTIONS 3	STARTING YOUR ENGINE 10
KNOW YOUR UNIT 5	USING YOUR TOOL AS A WEEDCUTTER 12
ASSEMBLY 6	USING YOUR TOOL AS A LINE TRIMMER 14
FUELING YOUR ENGINE 9	ACCESSORIES 18
	GENERAL MAINTENANCE 19

SPECIFICATIONS

ENGINE TYPE:	2-Cycle, Air Cooled
DISPLACEMENT:	30cc
ENGINE RPM:	Operating--7500 Idle--2600-3400
IGNITION:	Solid State
IGNITION TIMING:	Spark Advance - Nonadjustable
CARBURETOR:	Diaphragm All Position With Adjustable Fuel Mixture Jets
ENGINE "OFF":	Positive Switch
STARTER:	Auto Rewind
MUFFLER:	Temperature Limiting (not spark arresting)
CUTTING PATH:	18"
FUEL TANK:	500cc
SPARK PLUG:	Champion (CJ-14)
SPARK PLUG GAP:	.025"
MODULE AIR GAP:	.010" to .014"
LUBRICATION:	Gasoline/Oil Mixture - 40:1 (see "Fueling Your Engine")
CUTTING LINE:	.080" Diameter WEED LINE®
BLADE	4 point 8" Blade

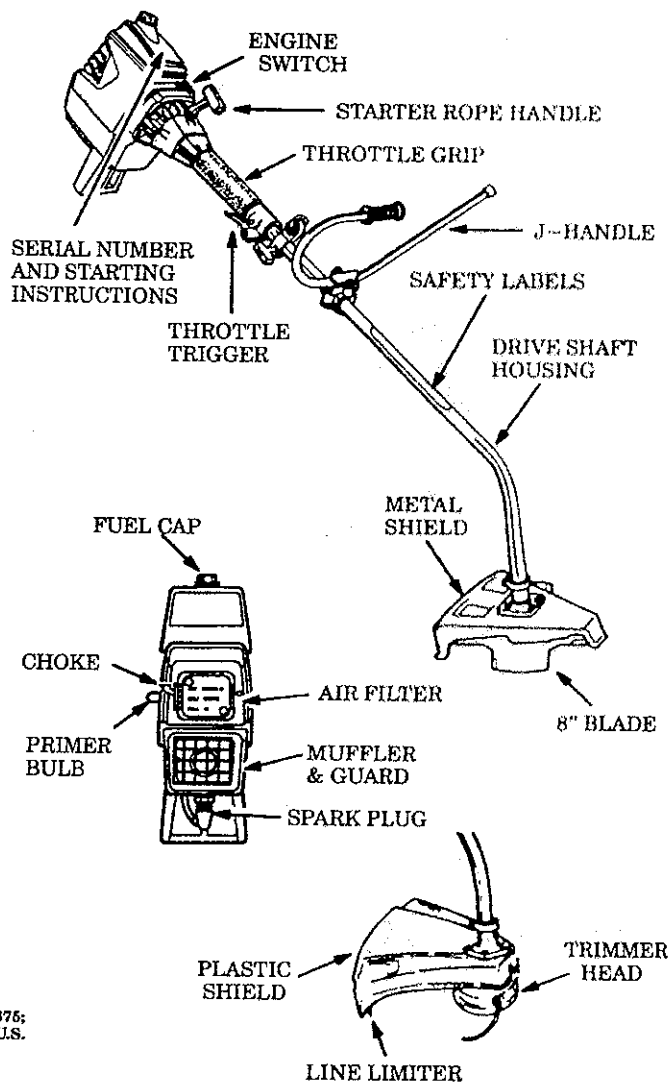

MANUFACTURED UNDER ONE OR MORE OF THE FOLLOWING U.S. PATENTS:
 4,035,912; 4,052,789; 4,161,820; 4,167,812; 4, 183,138; 4,189,833; 4,211,004; 4,286,875;
 4,362,074; 4,461,983; 4,798,185; 4,823,465; 4,841,928; 4,940,028; & D304,196. OTHER U.S.
 AND FOREIGN PATENTS PENDING.

SPECIAL NOTICE

For users on U.S. Forest Land and in some states, including California (Public Resources Codes 4442 and 4443), Idaho, Maine, Minnesota, New Jersey, Oregon, and Washington: Certain internal combustion engines operated on forest, brush, and/or grass-covered land in the above areas are required to be equipped with a spark arrestor, maintained in effective working order, or the engine must be constructed, equipped, and maintained for the prevention of fire. Check with your state or local authorities for regulations pertaining to these requirements. Failure to follow these requirements is a violation of the law. **This unit is not factory-equipped with a spark arrestor;** however, a spark arrestor is available as an optional part. If a spark arrestor is required in your area, contact your Authorized Service Dealer for the correct kit.

▲ WARNINGS AND SAFETY INSTRUCTIONS

(See Additional Safety Instructions throughout this Manual)

▲ DANGER – THIS POWER TOOL CAN BE DANGEROUS! This unit can cause serious injury including amputation or blindness to the operator and others. The warnings and safety instructions in this manual must be followed to provide reasonable safety and efficiency in using the unit. The operator is responsible for following the warnings and instructions in this manual and on the unit. Read the entire Operator's Manual before assembling and using the unit! Restrict the use of this unit to persons who read, understand, and follow the warnings and instructions in this manual and on the unit.



▲ DANGER
BLADE CAN THRUST VIOLENTLY AWAY FROM MATERIAL IT DOES NOT CUT.

- BLADE THRUST CAN CAUSE AMPUTATION OF ARMS OR LEGS.
- KEEP PEOPLE AND ANIMALS 30 FEET (10 METERS) AWAY.

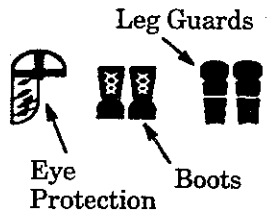
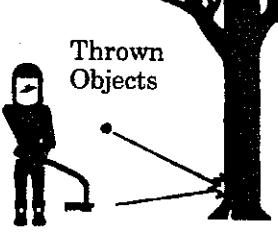
▲ WARNING
TRIMMER LINE CAN THROW OBJECTS VIOLENTLY.

- YOU CAN BE BLINDED OR INJURED.
- WEAR EYE AND LEG PROTECTION.

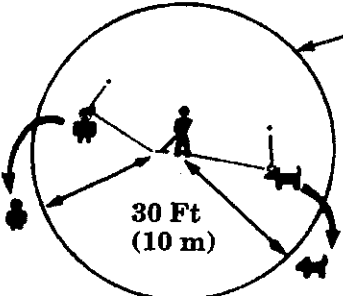

60 Foot (20 meter) Hazard Zone

30 Ft (10 m)

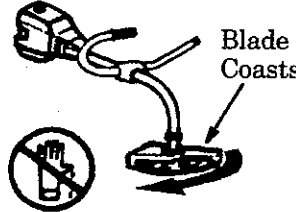
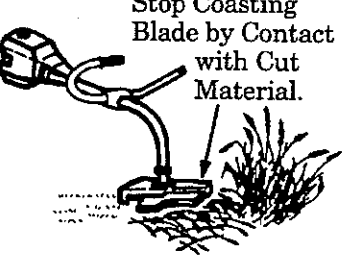

▲ WARNING
HAZARD ZONE FOR THROWN OBJECTS.

- BLADE/TRIMMER LINE CAN THROW OBJECTS VIOLENTLY.
- OTHERS CAN BE BLINDED OR INJURED.
- KEEP PEOPLE AND ANIMALS 30 FEET (10 METERS) AWAY.

▲ WARNING
BLADE COASTS AFTER THE THROTTLE IS RELEASED.

- THE BLADE CAN SERIOUSLY CUT YOU OR OTHERS.
- STOP THE BLADE WITH CUT MATERIAL.

▲ WARNING
READ OPERATOR'S MANUAL.

- FOLLOW ALL WARNINGS AND INSTRUCTIONS.
- FAILURE TO DO SO CAN RESULT IN SERIOUS INJURY.

WARNINGS AND SAFETY INSTRUCTIONS...(Continued)

▲ OPERATOR SAFETY

- Always wear safety eye protection.
- Always wear heavy, long pants, long sleeves, boots, and gloves. Wearing safety leg guards is recommended. Do not go barefoot or wear sandals, jewelry, short pants, short sleeves, loose clothing, or clothing with loosely hanging ties, straps, tassels, etc.; they can be caught in moving parts. Being fully covered will help protect you from pieces of toxic plants such as poison ivy thrown by blade or trimmer head which could be more of a hazard than touching the plant itself.
- Secure hair so it is above shoulder length.
- Do not operate unit when you are tired, ill, or under the influence of alcohol, drugs, or medication.
- Wear hearing protection if you use the unit for more than 1-1/2 hours per day.
- Never start or run the engine inside a closed room or building. Breathing exhaust fumes can kill.
- Keep handles free of oil and fuel.
- Always use the handlebar and a properly adjusted shoulder strap with a blade. See "Assembly."

▲ UNIT/MAINTENANCE SAFETY

- Look for and replace damaged or loose parts before each use. Look for and repair fuel leaks before use. Keep the unit in good working condition.
- Throw away blades that are bent, warped, cracked, broken, or damaged in any other way. Replace trimmer head parts that are cracked, chipped, broken, or damaged in any other way before using the unit.
- Maintain the unit according to recommended procedures. Keep the blade sharp. Keep the cutting line at the proper length.
- Use only .080" diameter WEED EATER® brand line. Never use wire, rope, string, etc.
- Install the required shield properly before using the unit. Use the metal shield for all weed blade use. Use the plastic shield for all line trimmer use.
- Use only specified blade or trimmer head; make sure it is properly installed and securely fastened.
- Never start engine with clutch shroud removed. The clutch can fly off and cause serious injury.
- Be sure blade or trimmer head stops turning when engine idles.
- Disconnect the spark plug before performing maintenance (except carburetor adjustments).
- Make carburetor adjustments with the lower end supported to prevent the blade or trimmer line from contacting any object. Hold the unit by hand; do not use the shoulder strap for support.
- Keep others away when making carburetor adjustments.
- Use only genuine WEED EATER accessories as recommended for this unit.

If situations occur which are not covered in this manual, use care and good judgment. If you need assistance, contact your Authorized Service Dealer or the CUSTOMER ASSISTANCE HOTLINE at 1-800-554-6723.

- Have all maintenance and service not explained in this manual performed by an Authorized Service Dealer.

▲ FUEL SAFETY

- Mix and pour fuel outdoors.
- Keep away from sparks or flames.
- Use a container approved for fuel.
- Do not smoke or allow smoking near fuel or the unit or while using the unit.
- Wipe up all fuel spills before starting engine.
- Move at least 10 feet (3 meters) away from fueling site before starting engine.
- Stop engine and allow unit to cool before removing fuel cap.
- Empty the fuel tank before storing the unit. Use up fuel left in the carburetor by starting the engine and letting it run until it stops.
- Store unit and fuel in an area where fuel vapors cannot reach sparks or open flames from water heaters, electric motors or switches, furnaces, etc.

▲ CUTTING SAFETY

- Inspect the area to be cut before each use. Remove objects (rocks, broken glass, nails, wire, string, etc.) which can be thrown or become entangled in the blade or trimmer head.
- Keep others including children, animals, bystanders, and helpers outside the 60 foot (20 meter) Hazard Zone. Stop the engine immediately if you are approached.
- Always keep engine on the right-hand side of your body.
- Hold the unit firmly with both hands.
- Keep firm footing and balance. Do not over-reach.
- Keep blade or trimmer head below waist level.
- Do not raise the engine above your waist.
- Keep all parts of your body away from blade, trimmer head, and muffler when engine is running.
- Cut from your right to your left.
- Use only for jobs explained in this manual.

▲ TRANSPORTING AND STORAGE

- Stop the unit before carrying.
- Keep the muffler away from your body.
- Allow engine to cool and secure unit before storing or transporting it in a vehicle.
- Empty the fuel tank before storing or transporting the unit. Use up fuel left in the carburetor by starting the engine and letting it run until it stops.
- Store unit and fuel in an area where fuel vapors cannot reach sparks or open flames from water heaters, electric motors or switches, furnaces, etc.
- Store unit so the blade or line limiter cannot accidentally cause injury. The unit can be hung by the bracket below engine or by tube.
- Store the unit out of reach of children.

SAFETY NOTICE

Exposure to vibrations through prolonged use of gasoline powered hand tools could cause blood vessel or nerve damage in the fingers, hands, and wrists of people prone to circulation disorders or abnormal swellings. Prolonged use in cold weather has been linked to blood vessel damage in otherwise healthy people. If symptoms occur such as numbness, pain, loss of strength, change in skin color or texture, or loss of feeling in the fingers, hands or wrists, discontinue the use of this tool and seek medical attention. An anti-vibration system does not guarantee the avoidance of these problems. Users who operate power tools on a continual and regular basis must monitor closely their physical condition and the condition of this tool.

KNOW YOUR UNIT

A. INTRODUCTION

Your Trimmer is a versatile product developed for large lawns and to make short work of a variety of lawn care tasks -- trimming, scalping, mowing, and sweeping.

Special Features Include:

- 18" Cutting Path
- TAP-N-GO® Cutting Head
- All-Position Carburetor
- 8 Inch, 4 Point Blade
- Shoulder Strap with Warning Decal
- Barrier Handlebar

B. UNPACKING INSTRUCTIONS

1. After removing the contents from the carton, check the parts against the list.
2. Examine the parts for damage. Do not use damaged parts.
3. *Notify your WEED EATER dealer immediately if a part is missing or damaged.*

NOTE: It is normal to hear the fuel filter rattle in an empty fuel tank.

C. CARTON CONTENTS

KEY NO.	QTY
• Engine/Drive Shaft/Bearing	
• Housing Assy. w/Safety Label	1
• Handlebar	1
• Plastic Shield - Trimmer Head	1
• Trimmer Head	1
• Metal Shield - Blade	1*
• Blade - 8 inch, 4 point	1*
• Shoulder Strap w/Warning	1
• Operator's Manual	1
• Loose Parts Bag	1

** LOOSE PARTS BAG CONTENTS:

• Mounting Block Cover -	
Handlebar	1
• Hex Wrench - 5/32"	1
• Hex Wrench - 3/16"	1
(The following hardware is illustrated below)	
A. Screw - Plastic Shield	4
B. Screw	6
C. Flat Washer - Blade	1*
D. Cupped Washer - Blade	1*
E. Flange Hex Nut - Blade	1*
F. Grass Washer - Trimmer Head	1
G. Retention Plate - Metal Shield	1

▲ WARNING

Parts marked with * are critical and must be supplied by Weed Eater. Failure to use the proper parts can cause the blade to fly off and seriously injure the operator or others.

D. HARDWARE USAGE

NOTE: This Hardware is packaged in the Plastic Bag. Refer to the Hardware reference letters below during assembly.

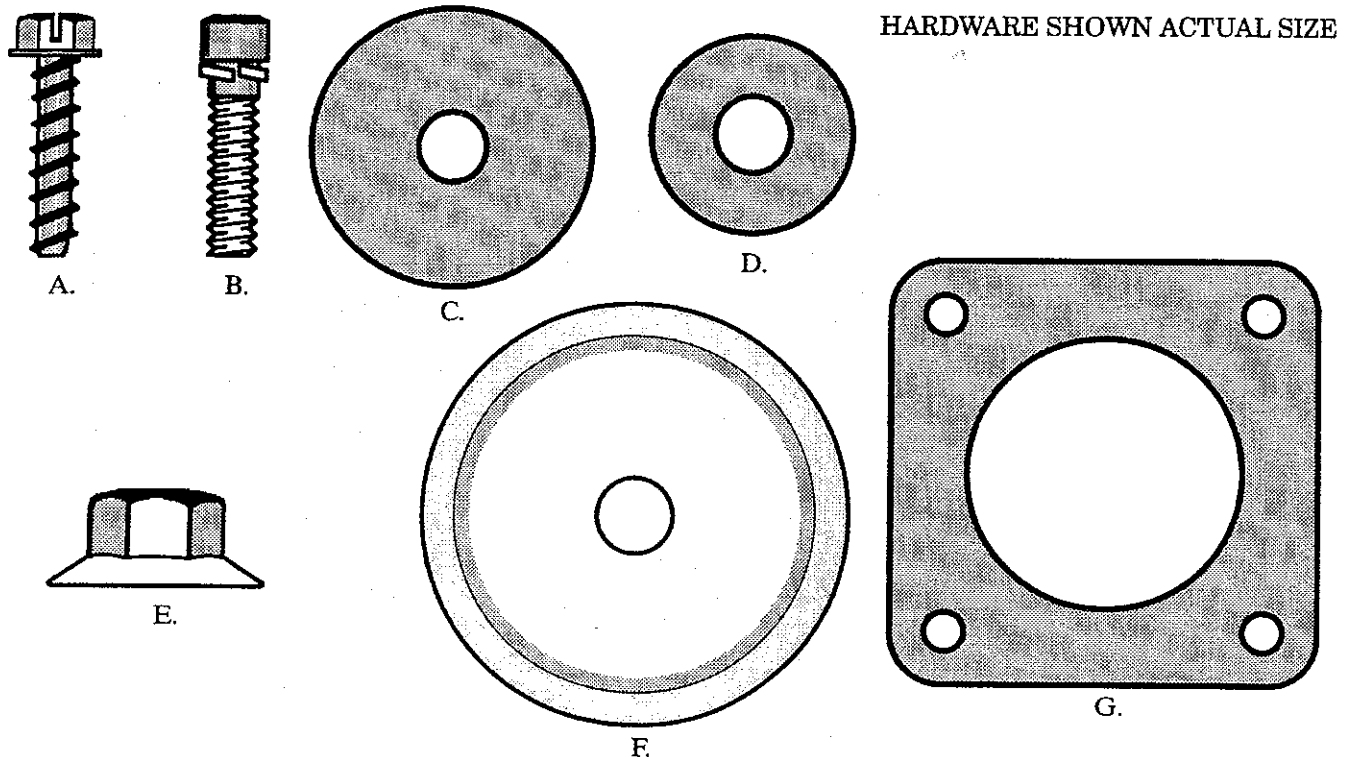

Figure 1

ASSEMBLY

(If tool is received assembled, repeat all steps in this section to be sure assembly is correct and is adjusted for the operator.)

A. PREPARATION

This Operator's Manual has been developed to help you assemble the tool and to provide its safe operation. It is important that you read the entire manual to become familiar with the tool *before* you begin assembly. If you have any questions or need further assistance, call our CUSTOMER ASSISTANCE HOTLINE at 1-800-554-6723.

1. Read your Operator's Manual

2. Tools you will need:

- Hex Wrench(s) provided with tool
- Adjustable Wrench
- Standard Screwdriver

B. FOR LINE TRIMMER USE

▲ WARNING

The plastic shield must be properly installed for all line trimmer usage. The plastic shield provides partial protection from the risk of thrown objects to the operator and others and is equipped with a line limiter which cuts excess line to the proper length.

▲ WARNING

Failure to install shield in the position shown in Figure 2 can result in serious injury to the operator. The length of the shield must be aligned with the length of the drive shaft housing. Direct the widest part of shield toward the engine.

NOTE: Remove the metal shield and blade before installing the plastic shield and trimmer head.

1. Place the shield under the bearing housing and align screw holes. Figure 2.

CAUTION: The line limiter (on the underside of the shield) is sharp and can cut you.

2. Insert screws "A." through the bearing housing into the shield. Figure 2.
3. Tighten the screws evenly and securely.
4. Remove the packing cover from the arbor shaft if so equipped.
5. Install grass washer "F." over the arbor shaft. Make sure the grass washer is against and curved over the dust cup. Figure 2.
6. Start threading the trimmer head onto the arbor shaft as shown in Figure 2.
7. Align the hole in the dust cup with the hole in the center front of the bearing housing by turning the dust cup. Then, insert the small hex wrench (provided) into the aligned holes to keep the arbor shaft from turning. Figure 2 (inset).

8. Tighten the trimmer head against the washer and dust cup while holding the hex wrench.
9. Remove the hex wrench.

NOTE: To remove the trimmer head, insert the hex wrench into the aligned holes in the dust cup and bearing housing. Unthread the trimmer head. Be sure to store grass washer "F.", plastic shield, 4 shield screws, and hardware with the trimmer head for future use.

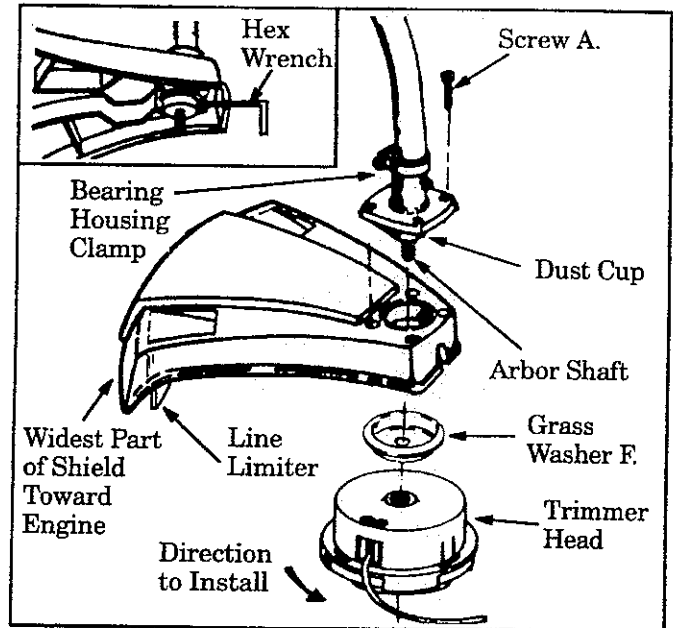

Figure 2

C. HANDLEBAR

▲ WARNING

The handlebar mounting block must be placed above the point of the arrow on the safety labels. The handlebar is a barrier to keep the blade away from the operator's feet.

1. Position the mounting block on the tube above the arrow on the safety labels. Figure 3.
2. Place one of the covers under the tube. Figure 3. Attach the cover to the mounting block with 2 screws "B."; finger tighten only.
3. Align the handlebar with the straight barrier portion to the left and the curved portion to the right as shown in Figure 3.
4. Position the short, straight section of the handlebar in the mounting block.
5. Place the other cover on top of the tube. Figure 3. Attach the cover to the mounting block with 2 screws "B."; finger tighten only.

▲ WARNING

The barrier portion of the handlebar must be installed as shown in Figure 3 to provide a barrier between operator and spinning blade.

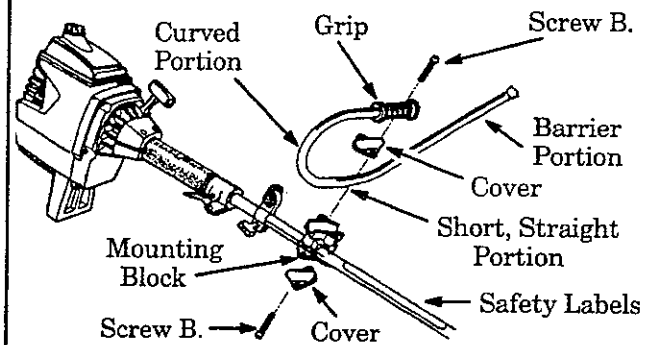

Figure 3

D. FOR BLADE USE

▲ DANGER

The metal shield and metal handlebar must be properly installed on the tool anytime the tool is used with the blade. The forward tip on the metal shield helps to reduce the occurrence of blade thrust which can cause serious injury such as amputation to the operator or bystanders.

▲ WARNING

Failure to install the shield in the position shown in Figures 4 and 5 can result in serious injury to the operator. The length of the shield must be aligned with the length of the drive shaft housing. Direct widest part of shield toward the engine.

NOTE: If your unit is equipped as a line trimmer, remove the plastic shield, grass washer, and trimmer head before installing the metal shield and blade. Be sure to store parts for future use.

1. Position retention plate "G." on the underside of the metal shield and align screw holes. Make sure flat side of plate is against the shield.
2. Hold retention plate "G." in position and place the metal shield under the bearing housing. Align screw holes. Figure 4.
3. Insert screws "B." (one at a time) through bearing housing, shield, and retention plate "G." Figure 4.
4. Tighten screws evenly & securely with hex wrench.
5. Remove packing cover from arbor shaft if so equipped.
6. Install the blade over arbor shaft, making sure the hole in the center of the blade is fitted around the raised center step on the dust cup. Figure 4.
7. Install washer "C.", cupped washer "D.", and nut "E." Figure 4. Be sure cupped washer "D." is installed as shown in the lower inset in Figure 4.
8. Align the hole in the dust cup with the hole in the side of the bearing housing by turning the dust cup. Figure 4 (upper inset).
9. Insert large hex wrench (provided) into the aligned holes to keep arbor shaft from turning. Figure 4.

10. Tighten nut "E." firmly with a wrench while holding hex wrench in position.
11. Remove the hex wrench.
12. Turn blade by hand. If the blade binds against the shield, the blade is not centered. Reinstall the blade.
13. Proceed to "Shoulder Strap" instructions.

NOTE: To remove the blade, insert the large hex wrench into aligned holes. Un-thread the hex flange nut and remove parts. Be sure to store the retention plate, hex flange nut, beveled washer, flat washer, shield screws, and metal shield with the blade for future use.

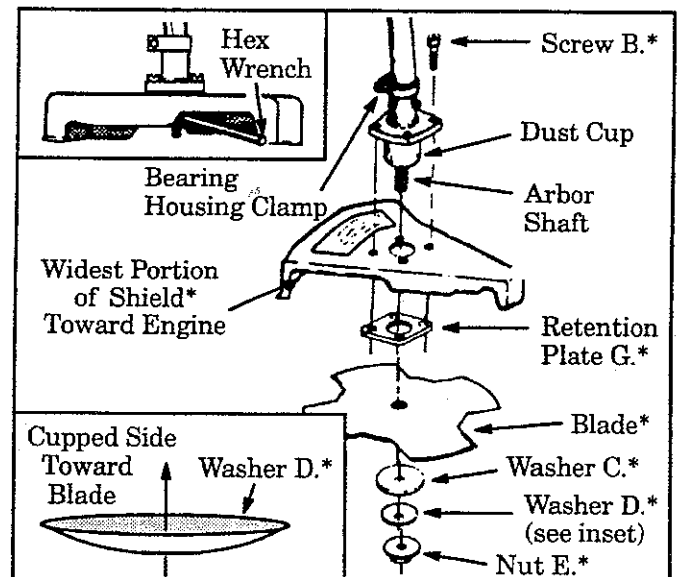

Figure 4

▲ WARNING

Parts noted with * are critical and must be supplied by Weed Eater. Failure to use proper parts can cause the blade to fly off and seriously hurt you or others.

E. SHOULDER STRAP

▲ WARNING

Proper shoulder strap and handlebar adjustments before starting the engine are required for safe and efficient use.

1. Try on shoulder strap and adjust for fit and balance before starting the engine and beginning a cutting operation.
2. Place shoulder strap on your left shoulder with the Danger Sign on your back and hook to the right side of your waist. Figure 5.

NOTE: A one-half twist is built in the shoulder strap to allow the strap to rest flat on the shoulder.

To make sure the strap rests flat on your body, place the double portion across your front and the single portion across your back.

3. Adjust the strap so that the hook will be about 10 inches below the waist when the hook is attached to the shoulder strap.
4. Fasten the shoulder strap hook to the clamp and lift the tool to the operating position. Figure 5.
5. Check for the following:
 - a. Left arm fully extended, hand holding handlebar grip.
 - b. Right hand holding the top handle, fingers on the throttle trigger.
 - c. Engine below waist level.
 - d. Shoulder strap pad centered on left shoulder.
 - e. Danger sign centered on your back.
 - f. Full weight of tool on left shoulder.
 - g. Without operator bending over, the blade or trimmer head is near and parallel to the ground and easily contacts material to be cut.
6. Modify these initial adjustments as necessary for comfort and control but do not locate the handlebar mounting block below the point of the arrow on the safety labels. Do not locate the shoulder strap clamp in any position other than between engine and handlebar mounting block.
7. Position the handlebar for height. See Figure 6.
8. Be sure the handlebar is installed correctly, then tighten each screw securely with the large hex wrench.

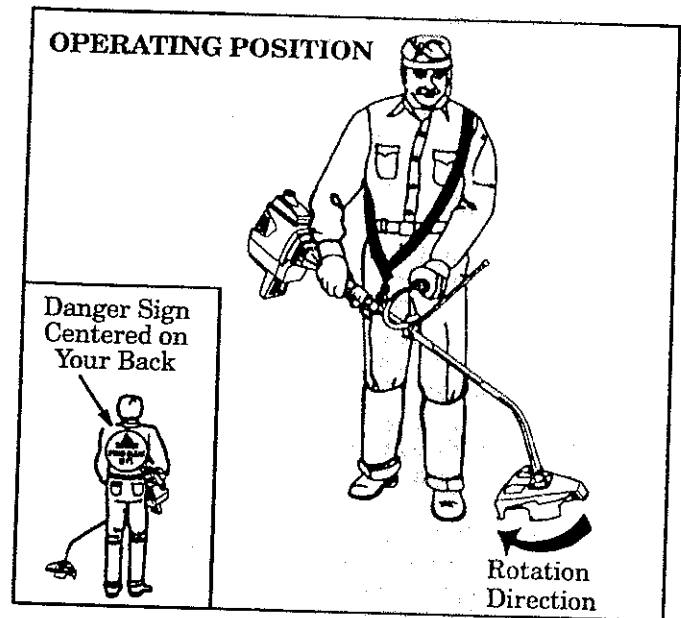

Figure 5

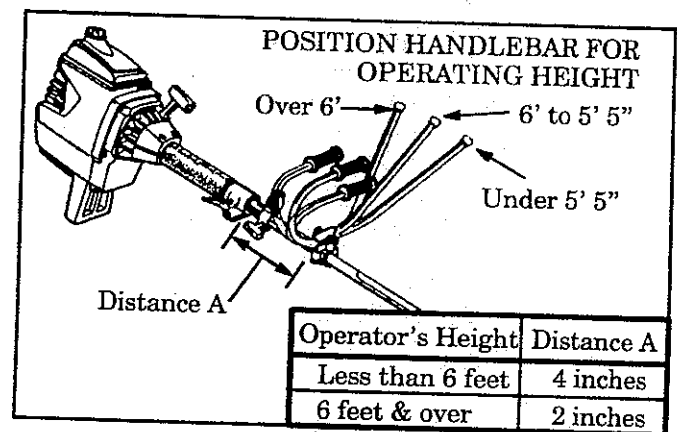

Figure 6

NOTES

FUELING YOUR ENGINE

FUEL SAFETY

- Be sure to read the fuel safety section on page 4 of this manual before you begin.
- If you do not understand the fuel safety section **DO NOT** attempt to fuel your unit; seek help from someone that does understand the fuel safety section or call our Customer Assistance Hotline at 1-800-554-6723.

FUEL MIXTURE

- Your unit is powered by a two-cycle engine that requires a fuel mixture of regular unleaded gasoline and a high quality engine oil specially made for 2-cycle, air cooled engines.
- Gasoline must be clean and not over two months old.

CAUTION: Too little oil or incorrect oil will cause the engine to overheat and seize.

- Always mix the fuel thoroughly in a container since gasoline and oil do not readily combine.

DO NOT USE:

- **AUTOMOTIVE OIL**
- **NMMA OIL** for boat engines

These oils do not have proper additives for 2-cycle, air-cooled engines and can cause engine damage.

USE THE FOLLOWING OIL:

- WEED EATER 40:1, 2-cycle engine oil

Paramount, Poulan, or Poulan Pro brand 40:1, 2-cycle engine oil is acceptable if mixed according to the instructions on the container.

40 PARTS GASOLINE TO 1 PART OIL=

1 gallon gasoline to 3.2 fl. oz. oil

2.5 gallon gasoline to 8.0 fl. oz. oil

HOW MUCH OIL TO USE:

WEED EATER 40:1, 2-cycle engine oil is sold in both 3.2 ounce and 8 ounce containers. When you buy the 3.2 ounce container, mix it with 1 gallon of regular unleaded gasoline. If you purchase the 8 ounce container, mix it with 2-1/2 gallons of regular unleaded gasoline. Both of the above mixtures will provide 40 parts gasoline to 1 part oil.

Paramount, Poulan, or Poulan Pro brand 40:1, 2-cycle engine oil is also sold in the same size containers and may be mixed in the same manner.

WHAT TO DO IF YOU USE ANOTHER BRAND OF OIL:

Not all air cooled, 2-cycle engine oils have the same qualities. If WEED EATER, Paramount, Poulan, or Poulan Pro brand 2-cycle engine oil is not available, use a high quality 2-cycle engine oil recommended for air cooled engines. Mix at a ratio of 40:1 by mixing 3.2 ounces oil with 1 gallon of gasoline. 40:1 must be listed as a suggested mix ratio.

HOW TO MIX FUEL AND FILL TANK

NOTE: Do not mix gasoline and oil directly in the fuel tank.

- Pour the proper measure of engine oil into an approved, marked fuel container. Then, fill the container with regular unleaded gasoline.

NOTE: If gasoline is already in the container, add the proper measure of 2-cycle engine oil. Then, close the container tightly and shake it momentarily.

- Slowly remove the fuel cap.
- Using a spout or funnel, fill the fuel tank with fuel mix.
- Reinstall the fuel cap securely.

STARTING YOUR ENGINE

(For location of controls, refer to "Specifications.")

BEFORE STARTING THE ENGINE:

- Fuel engine. Move 10 feet (3 meters) away from fueling site.

▲ WARNING

The trimmer head will turn when the engine starts.

- Rest engine and shield on ground, supporting trimmer head off ground.

NOTE: Remove and discard the plastic shipping guard on the primer bulb (if so equipped).

STARTING A COLD ENGINE OR WARM ENGINE AFTER RUNNING OUT OF FUEL:

- Make sure the switch is in the "On" position.
- Move the choke lever to the "Full Choke" position.
- Slowly press the primer bulb 6 times.
- Squeeze and hold the throttle trigger. *Keep the throttle trigger fully squeezed until the engine runs smoothly.*
- Pull starter rope sharply 5 times.

NOTE: The engine may sound as if it is trying to start before the 5th pull. If so, go to the next step immediately.

- Move the choke lever to the "Half Choke" position.
- Pull the starter rope sharply until the engine runs, but no more than 6 pulls.

NOTE: If the engine has not started after 6 pulls (at half choke), check to make sure the switch and the choke lever are in the proper positions. Then, move the choke lever to the "Full Choke" position and press the primer bulb 6 times; squeeze and hold the throttle trigger and pull the starter rope 2 more times. Move the choke lever to "Half Choke" and pull the starter rope until the engine runs, but no more than 6 more pulls.

NOTE: If the engine still has not started, it is probably flooded. Proceed to "Starting a Flooded Engine."

- Allow the engine to run 15 seconds, then move the choke lever to "Off Choke." Allow the unit to run for 30 more seconds at "Off Choke" before releasing the throttle trigger.

NOTE: If engine dies with the choke lever at the "Off Choke" position, move the choke lever to "Half Choke" and pull the rope until the engine runs.

- To stop the engine, move the switch to "Off."

▲ WARNING

Avoid any bodily contact with the muffler when starting a warm engine. A hot muffler can cause serious burns.

STARTING A WARM ENGINE THAT HAS NOT RUN OUT OF FUEL:

- Make sure the switch is in the "On" position.
- Move the choke lever to the "Half Choke" position.
- Squeeze and hold the throttle trigger. *Keep the throttle trigger fully squeezed until the engine runs smoothly.*
- Pull starter rope sharply until engine runs, but no more than 5 pulls.
- Allow the engine to run 15 seconds, then move the choke lever to "Off Choke."

NOTE: If engine has not started, pull starter rope 5 more pulls. If engine still does not run, it is probably flooded. Proceed to "Starting a Flooded Engine."

- To stop the engine, move switch to the "Off" position.

STARTING A FLOODED ENGINE:

Flooded engines can be started by placing the switch in the "On" position and the choke lever in the "Off Choke" position; then, pull the rope to clear the engine of excess fuel. This could require pulling the starter rope *many times* depending on how badly the unit is flooded.

If the unit still doesn't start, call the Customer Assistance Hotline at 1-800-554-6723.

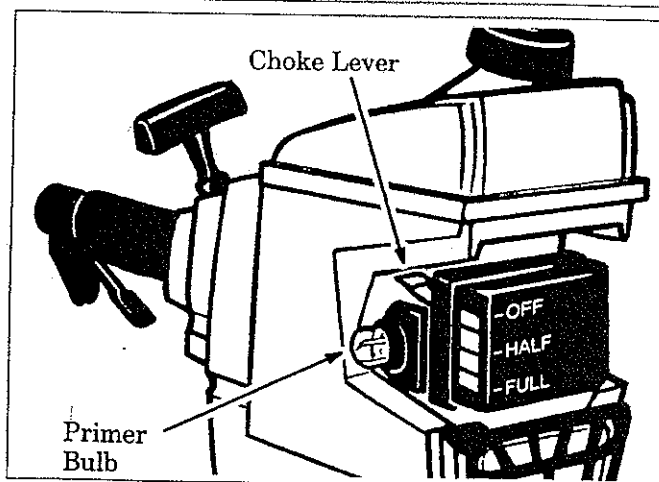
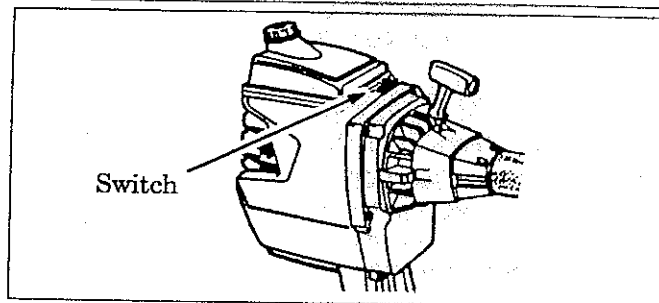
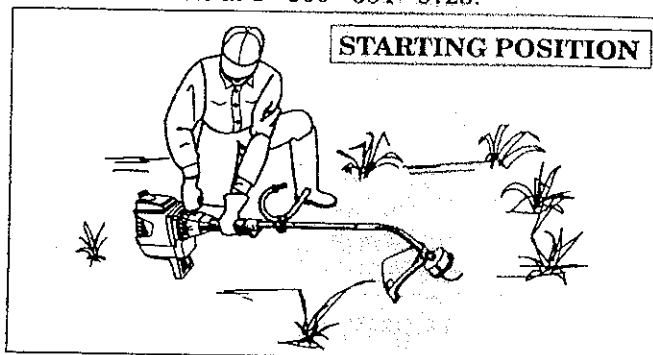

OPERATING INSTRUCTIONS

- **When using the blade,** bring the engine to full throttle before entering the material to be cut. The blade has maximum cutting power at full throttle and is less likely to bind, stall, or cause blade thrust, which can result in serious injury to the operator or others. Refer to "Guard Against Blade Thrust".
- **When using the trimmer head,** do not run the engine at a higher speed than necessary. The cutting line will cut efficiently when the engine is run at less than full throttle. At lower speeds, there is less engine noise and vibration. The cutting line will last longer and will be less likely to "weld" onto the spool.
- **If the blade or trimmer head does not turn when the engine is accelerated,** make sure the tube is properly seated in the engine shroud.
- **Always release throttle trigger and allow engine to return to idle speed when not cutting.**
- **The blade or trimmer head should not turn when the engine runs at idle speed.** If the blade or trimmer head on your unit turns when the engine is at idle speed, refer to "Trouble Shooting Chart."
- **To stop engine:**
 - Release the throttle trigger.
 - Move ignition switch to the "Off" position. Figure 8.
 - Stop the blade by allowing the "9 o'clock" position to contact cut material. Figure 10.

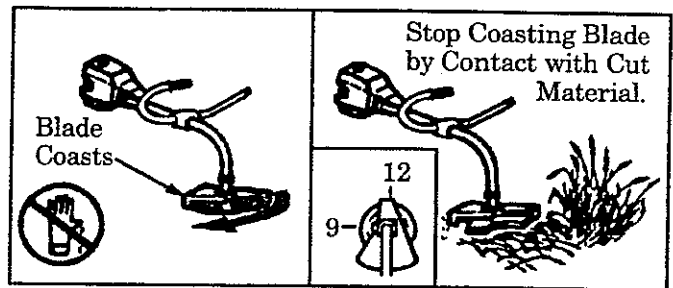

Figure 10

▲ WARNING

The blade continues to spin after the engine is turned off. The coasting blade can throw objects or seriously cut you if accidentally touched. Stop blade by contacting the left-hand side of the coasting blade with material already cut.

▲ WARNING

The operator or others must not try to clear away cut material with the engine running or the blade turning to avoid serious injury. Stop engine and blade before removing materials wrapped around blade.

NOTES

USING YOUR TOOL AS A WEEDCUTTER – w/BLADE

(The 4 point, 8 inch blade is designed to cut grass, weeds and woody brush up to 1/2 inch diameter.)

▲ DANGER – THIS POWER TOOL CAN BE DANGEROUS!

This tool can cause serious injury including amputation or blindness to the operator and others. The warnings and safety instructions in this manual must be followed to provide reasonable safety and efficiency in using this tool. The operator is responsible for following the warnings and instructions in this manual and on the tool. Read the entire Operator's Manual before using this tool! Restrict the use of this power tool to persons who read, understand and follow the warnings and instructions in this manual and on the tool.

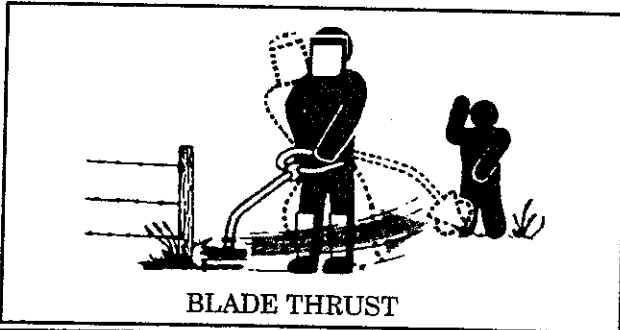

▲ **DANGER – BLADE THRUST** When the spinning blade contacts anything it does not cut, a dangerous reaction can occur causing the entire tool and operator to be thrust violently in any direction. This reaction is called Blade Thrust. As a result, the operator can lose control of the tool. Use handlebar, shoulder strap, and keep shield in place. Make sure others are at least 30 feet (10 meters) away. Keep blade sharp. Cut at full throttle and from your right to left. Keep hands, feet and tool in proper position; refer to "Guard Against Blade Thrust."

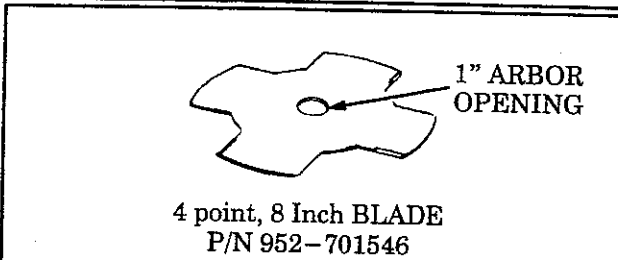

▲ DANGER – PROPER BLADE

Use only the 4 point, 8 inch blade and proper hardware. The use of any other parts can result in serious injury. Do not use any accessory or attachment other than those recommended by the manufacturer for use with this tool. Blades that are bent, warped, cracked, broken, or damaged can fly apart and cause serious injury. Do not use. Throw away.

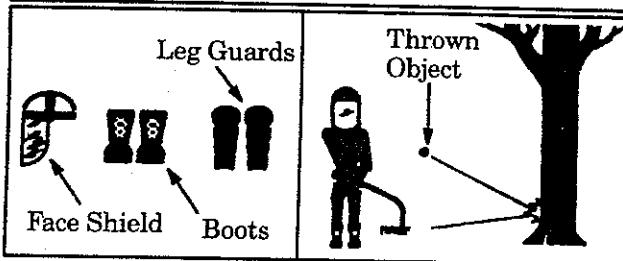

▲ WARNING – THROWS OBJECTS

The rapidly moving blade causes objects to be thrown violently. The shield will not provide complete protection to the operator or others. The operator must wear a safety face shield or goggles. Always wear safety leg guards and boots. Keep others at least 30 feet away.

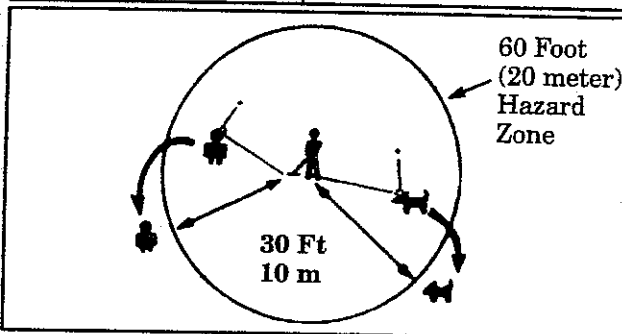

▲ WARNING – HAZARD ZONE

This tool will throw objects and cut. Keep others including children, animals, bystanders, and helpers at least 30 feet (10 meters) away from the operator and tool. Stop the engine and blade immediately if you are approached.

NOTE: In areas where other people and animals are present, such as near sidewalks, streets, houses, etc., it is strongly recommended that the operator use the buddy system; that is, have another person serve as a "look out," keeping himself and others at least 30 feet (10 meters) away from the operator.

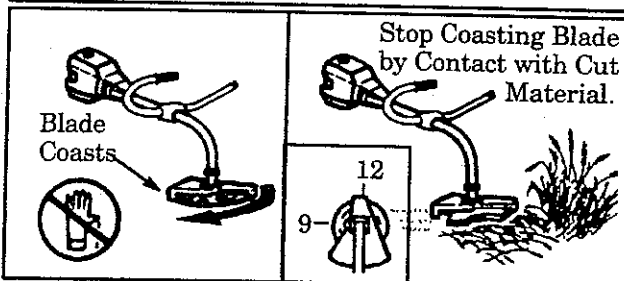

▲ WARNING – COASTING BLADE

The blade continues to spin after the engine is stopped or the throttle is released. The coasting blade can thrust, throw objects, or seriously cut you if accidentally touched. Stop blade by leaving it in contact with material already cut. Use the "9 o'clock" position as the point of contact.

A. BLADE SAFETY

1. OPERATOR SAFETY

- a. Always wear a safety face shield or goggles. See "Accessories."
- b. Always wear heavy, long pants, long sleeves, boots, gloves and safety leg guards. See "Accessories." Do not wear loose clothing, jewelry, short pants, short sleeves, sandals, or go barefoot. Secure hair so it is above shoulder length.
- c. Do not operate this tool when you are tired, ill or under the influence of alcohol, drugs or medication.
- d. Always use the handlebar and a properly adjusted shoulder strap. See "Assembly."
- e. Do not swing the tool with such force that you are in danger of losing your balance.
- f. Never start or run the engine inside a closed room or building. Breathing exhaust fumes can kill.
- g. Keep handles free of oil and fuel.

2. TOOL SAFETY

- a. Inspect the entire tool before each use. Replace damaged parts. Check for fuel leaks and make sure all fasteners are in place and securely fastened.
- b. Be sure the metal shield is properly attached. The metal shield *must* be installed for all blade usage.

- c. Make sure the blade is properly installed and securely fastened. Refer to "Assembly."
- d. Be sure the blade stops turning when the engine idles. See "Trouble Shooting Chart."
- e. Make carburetor adjustments with the lower end supported to prevent the blade from contacting any object. Hold tool by hand; do not use shoulder strap for support.
- f. Keep others away when making carburetor adjustments.

3. CUTTING SAFETY

- a. Inspect the area to be cut before each use. Remove objects (rocks, broken glass, nails, wire, string, etc.) which can be thrown or become entangled in the blade.
- b. Always keep the engine on the right side of your body. Hold the tool firmly with both hands.
- c. Keep firm footing and balance. Do not over-reach.
- d. Keep blade below waist level.
- e. Do not raise the engine above your waist. The blade can come dangerously close to your body.
- f. Cut at full throttle .
- g. Cut from your right to your left.
- h. Use only for jobs explained in this manual. Do not use the blade as an edger. The shield does not provide adequate protection.

B. GUARD AGAINST BLADE THRUST

- *Blade Thrust* is a reaction that only occurs when using a bladed tool. This reaction can cause serious injury such as amputation. Carefully study this section. It is important that you understand what causes *blade thrust*, how you can reduce the chance of its occurring, and how you can remain in control of the tool if *blade thrust* occurs.
- The forward tip on the shield helps to reduce the occurrence of *blade thrust* but cannot prevent the occurrence. The operator must follow the warnings and safety instructions in this section to lessen the chance of *blade thrust* occurring and to maintain control of the tool if the reaction does occur.

1. **WHAT CAUSES BLADE THRUST.** *Blade Thrust* can occur when the spinning blade contacts an object that it does not cut. This contact causes the blade to stop for an instant and then suddenly move or "thrust" away from the object that was hit. The "thrusting" reaction can be violent enough to cause the operator to be propelled in any direction and lose control of the tool. The uncontrolled tool can cause serious injury if the blade contacts the operator or others. Figure 11 .
2. **WHEN BLADE THRUST OCCURS.** *Blade thrust* can occur without warning if the blade snags, stalls, or binds. This is more likely to occur in areas where it is difficult to see the material being cut. By using the tool properly, the occurrence of *blade thrust* will be reduced and the operator will be less likely to lose control.

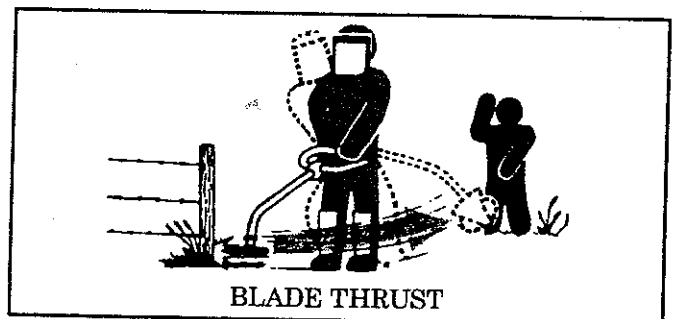

Figure 11

3. **REDUCE THE CHANCE OF BLADE THRUST**
 - a. Cut only grass, weeds and woody brush up to 1/2 inch diameter. Do not let the blade contact material it cannot cut such as stumps, rocks, fences, metal, etc., or clusters of hard, woody brush having a diameter greater than 1/2 inch.
 - b. Keep the blade sharp. A dull blade is more likely to snag.
 - c. Cut only a full throttle. The blade has maximum cutting power at full throttle and is less likely to bind or stall.
 - d. "Feed" the blade deliberately and not too rapidly. The blade can thrust away if it is fed too rapidly.
 - e. Cut only from your right to left. Swinging the tool in the same direction as the blade spins increases the cutting action.

4. MAINTAIN CONTROL

- a. Use the shoulder strap and keep a firm grip on the tool with both hands. A properly adjusted shoulder strap will support the weight of the tool, freeing your arms and hands to control and guide the cutting motion.
- b. Keep feet comfortably spread apart and braced for the possibility of a sudden, rapid thrust of the tool. Do not overreach. Keep firm footing and balance.
- c. Keep the blade below waist level. It will be easier to maintain control of the tool.
- d. Do not raise the engine above your waist as the blade can come dangerously close to your body.
- e. Do not swing the tool with such force that you are in danger of losing your balance.

C. CUTTING METHODS

1. Establish a rhythmic cutting procedure.
 - a. Plant feet firmly, comfortably apart.
 - b. Cut while swinging the upper part of your body from right to left.
 - c. Move forward to the next area to be cut after the return swing and plant feet once more.
2. Use the 8 o'clock to 10 o'clock position for cutting. Figure 12.
3. Stop the engine and blade, then unclip the shoulder strap from the tool before clearing cut material.
4. To reduce the chance of material wrapping around the blade, follow these steps:
 - a. Cut at full throttle.
 - b. Swing the tool into material to be cut from your right to left.
 - c. Avoid the material just cut as you make the return swing.

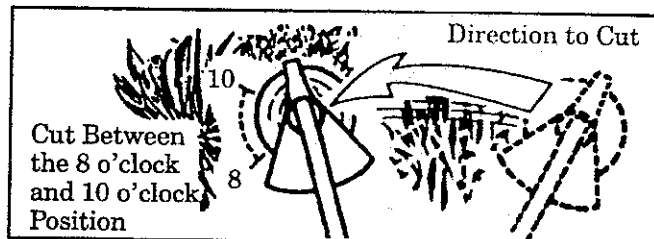
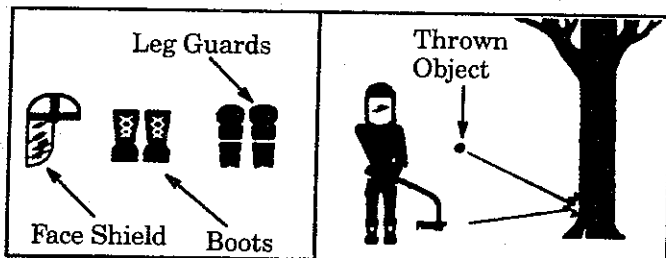

Figure 12

▲ WARNING

The operator or others must not try to clear away cut material with the engine running or the blade turning to avoid serious injury. Stop engine and blade before removing materials wrapped around blade.

USING YOUR TOOL AS A LINE TRIMMER



▲ WARNING - THROWS OBJECTS

The rapidly moving line causes objects to be thrown violently. The shield will not provide complete protection to the operator or others. The operator must wear a safety face shield or goggles. Always wear heavy, long pants and boots. Keep others at least 30 feet (10 meters) away.

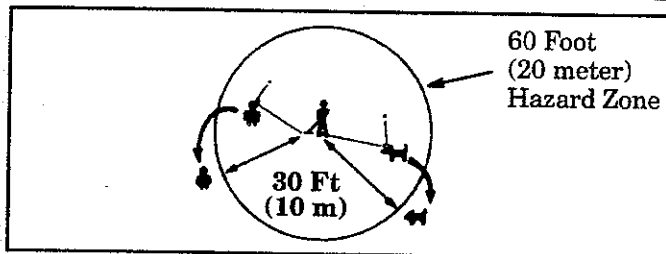

▲ WARNING - HAZARD ZONE

This tool will throw objects and cut. Keep others including children, animals, bystanders and helpers at least 30 feet (10 meters) away from the operator and tool. Stop the engine if you are approached.

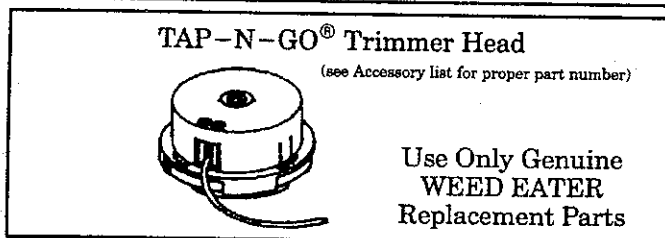

▲ WARNING - DAMAGED TRIMMER HEAD

Trimmer head parts that are chipped, cracked or damaged in any other way can fly apart and cause serious injury. Do not use. Replace damaged parts before using the tool.

A. TRIMMER SAFETY

1. OPERATOR SAFETY

- a. **Always wear eye protection** when operating, servicing, or performing maintenance on your unit. See "Accessories."
- b. **Always wear heavy, long pants, long sleeves, boots, and gloves.** See "Accessories." Do not go barefoot or wear sandals, jewelry, short pants, short sleeves, loose clothing, or clothing with loosely hanging ties, straps, or tassels; they can be caught in moving parts. Wearing safety leg guards is recommended. Secure hair so it is above shoulder length. Being fully covered will help protect you from pieces of toxic plants such as poison ivy thrown by trimmer head, which could be more of a hazard than touching the plant itself.
- c. **Do not operate this tool when you are tired, ill or under the influence of alcohol, drugs or medication.**
- d. **Do not swing the tool** with such force that you are in danger of losing your balance.
- e. **Never start or run the engine inside a closed room or building.** Breathing exhaust fumes can kill.
- f. **Keep handles free of oil and fuel.**

2. TOOL SAFETY

- a. **Inspect the entire tool before each use.** Replace damaged parts. Check for fuel leaks and make sure all fasteners are in place and securely fastened.
- b. **Use only .080" diameter WEED EATER brand Line.** Never use wire or rope, string, etc.
- c. **Be sure the plastic shield is properly at-**

tached. The plastic shield *must be* installed for all line trimmer usage.

- d. **Make sure the trimmer head is properly installed and securely fastened.** Refer to "Assembly."
- e. **Be the sure trimmer head stops turning when the engine idles.** See "Carburetor Adjustments."
- f. **Make carburetor adjustments with the lower end supported** to prevent the trimmer line from contacting any object. Hold tool by hand; do not use the shoulder strap for support.
- g. **Keep others away when making carburetor adjustments.**
- h. Use only genuine WEED EATER accessories or attachments as recommended.

3. CUTTING SAFETY

- a. **Inspect the area to be cut before each use.** Remove objects (rocks, broken glass, nails, wire, string, etc.) which can be thrown or become entangled in the trimmer head.
- b. **Always keep the engine on the right-hand side of your body.**
- c. **Hold the tool firmly with both hands.**
- d. **Keep firm footing and balance.** Do not over-reach.
- e. **Keep the trimmer head below waist level.**
- f. **Do not raise the engine above your waist.**
- g. **Keep all parts of your body away from the trimmer line and muffler when the engine is running.**
- h. **Use only for jobs explained in this manual.**

B. TRIMMER LINE ADVANCE

- **The trimmer line will advance approximately 2 inches each time the bottom of the trimmer head is tapped on the ground with the engine running at full throttle.**
- **The most efficient line length is the maximum length allowed by the line limiter.**
- **Always keep the shield in place when the tool is being operated. Figure 13 .**
- **To Advance Line:**
 1. Operate the engine at full throttle.
 2. Hold the trimmer head parallel to and above the grassy area.
 3. Tap the bottom of the trimmer head lightly on the ground one time. See Figure 13 . Approximately 2 inches of line will be advanced with each tap.

NOTE: Always tap trimmer head on a grassy area. Tapping on surfaces such as concrete or asphalt can cause excessive wear to the trimmer head.

NOTE: If the line is worn down to two inches or less, more than one tap will be required to obtain the most efficient line length.

▲ WARNING

Use only .080" diameter WEED EATER brand line. Other sizes of line will not advance properly. Do not use other materials such as wire, string, rope, etc. Wire can break off during cutting and become a dangerous missile that can possibly cause serious injury.

▲ WARNING

Use minimum speed and do not crowd the line when cutting around hard objects (rock, gravel, fence posts, etc), which can damage the trimmer head, become entangled in the line, or be thrown causing a serious hazard.

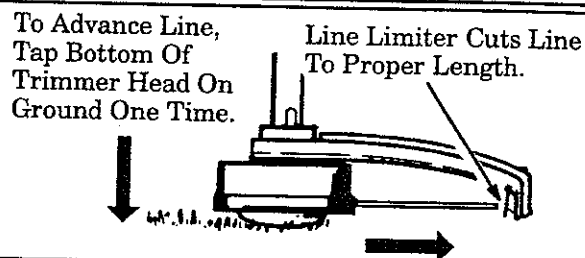

Figure 13

C. CUTTING METHODS

▲ WARNING

Use minimum speed and do not crowd the line when cutting around hard objects (rock, gravel, fence posts, etc), which can damage the trimmer head, become entangled in the line, or be thrown causing a serious hazard.

- **The tip of the line does the cutting.** You will achieve the best performance and minimum line wear by not crowding line into cutting area. The right and wrong ways are shown in Figure 14 .
- **The line will easily remove grass and weeds from around walls, fences, trees and flower beds, but it also can cut the tender bark of trees or shrubs and scar fences.** To help avoid damage especially to delicate vegetation or trees with tender bark, shorten line to 4–5 inches and use at less than full throttle.
- **For trimming or scalping,** use less than full throttle to increase line life and decrease head wear, especially:
 - during light duty cutting.
 - near objects around which the line can wrap such as small posts, trees or fence wire.
- **For mowing or sweeping,** use full throttle for a good clean job.

▲ WARNING

Always wear eye protection. Never lean over the trimmer head. Rocks or debris can ricochet or be thrown into eyes and face and cause blindness or other serious injury.

1. **TRIMMING – Figure 15 .** Hold the bottom of the trimmer head about 3 inches above the ground and at an angle. Allow only the tip of the line to make contact. Do not force the trimmer line into the work area.
2. **SCALPING – FIGURE 16 .** The scalping technique removes unwanted vegetation. Hold the bottom of the trimmer head about 3 inches above the ground and at an angle. Allow tip of line to strike ground around trees, posts, monuments, etc. *This technique increases line wear.*
3. **MOWING– Figure 17 .** Your trimmer is ideal for mowing in places conventional lawn mowers cannot reach. In the mowing position, keep the line parallel to the ground. Avoid pressing the head into the ground as this can scalp the ground and damage the unit.
4. **SWEEPING – Figure 18 .** The fanning action of the rotating line can be used for a quick and easy clean up. Keep the line parallel to and above the surfaces being swept and move the unit from side to side.

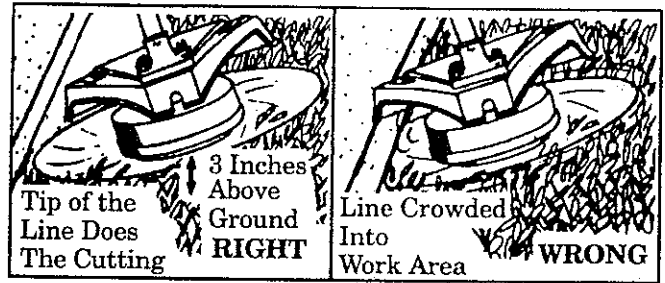

Figure 14

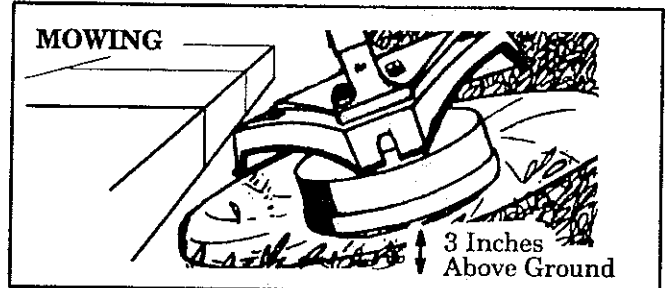

Figure 15

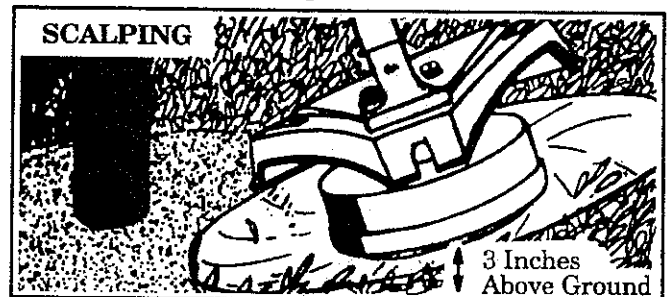

Figure 16

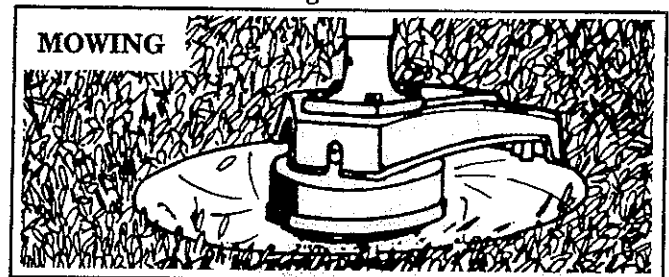

Figure 17

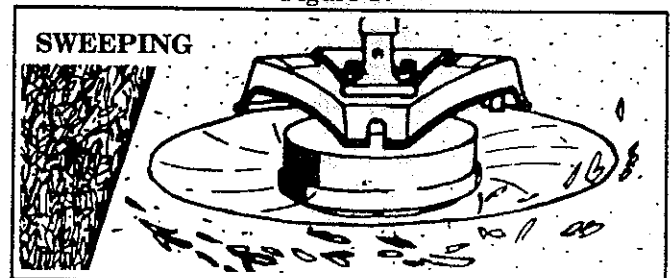

Figure 18

NOTES

D. LINE REPLACEMENT

- For proper line feed:
 - Use only genuine WEED EATER pre-wound spools and .080" diameter WEED EATER brand line. Use of other types of spools or lines can result in excessive breakage, line welding and improper line feed.
 - Pre-wound spools offer the most convenient method for replacing line as well as optimum performance.
- Always clean dirt and debris from spool and hub when performing any type maintenance.

1. Installing Spool with Line

- a. Hold the trimmer head as shown in Figure 19. Press the lock tab and turn the lock ring as shown in Figure 19.
- b. Remove the lock ring, tap button, and spool. Figure 20.
- c. Clean dirt and debris from all parts.
- d. Inspect all trimmer head parts for damage. Replace damaged parts.

▲ WARNING
 Trimmer head parts that are chipped, cracked, broken, or damaged in any other way can fly apart and cause serious injury. Do not use. Replace damaged parts before using the tool.

NOTE: The aluminum line saver (Figure 21) can become worn during use. After a groove is worn into the line saver, remove it from the trimmer head, turn it upside down, and reinstall it (with the spool removed) to provide a new wear surface.

▲ WARNING
 The line saver must be installed only from the inside of the trimmer head. If installed on the outside of the trimmer head, the line saver can fly off and become a dangerous missile.

- e. Insert the end of the line through the line saver. Figure 21. Place the spool in trimmer head. Press the spool down, then turn it enough to lock the lugs on the spool under the lugs on the drive gear. Figure 20.

NOTE: Make sure the line is not caught between the rim of spool and the wall of trimmer head.

- f. Replace the tap button. Align the lock ring over the catches on the hub; push the lock ring down on the hub and turn it clockwise until the catches lock into place. Figure 21.

▲ WARNING
 All catches must be fastened and the lock tab latched in the Lock Ring. If installed incorrectly, the Lock Ring can fly off and become a dangerous missile.

- g. Check to make sure the lock ring is properly fastened by trying to turn it counterclockwise and pulling on it. If it comes off, reinstall it properly.
- h. Pull on the line to change the spool from the locked position to the operating position.

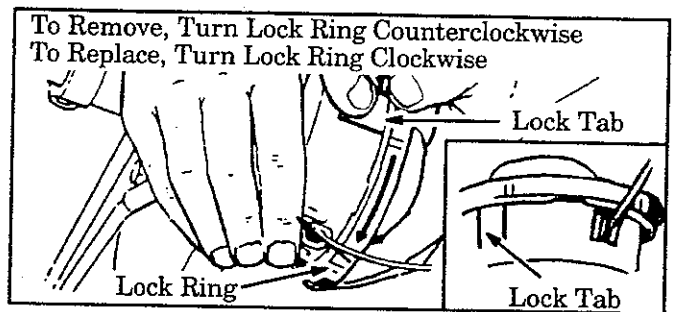

Figure 19

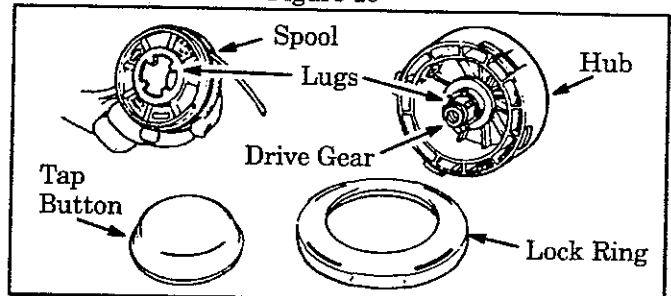

Figure 20

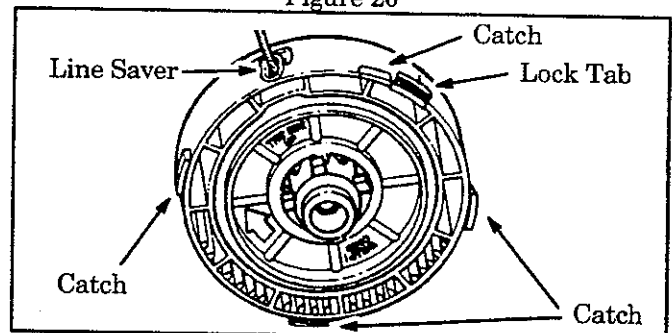

Figure 21

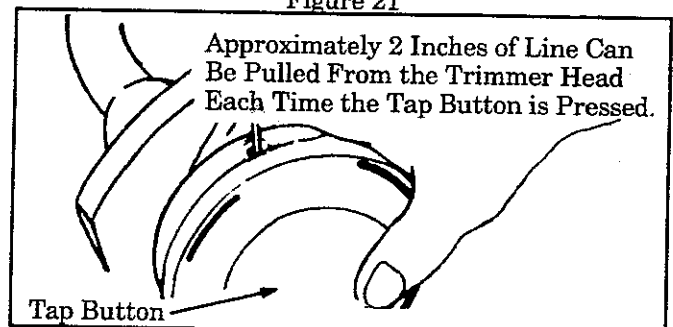

Figure 22

- i. Obtain the correct line length (4-6 inches) by pressing the tap button (Figure 22) and pulling on the line again.

NOTE: Each time the tap button is pressed, approximately 2 inches of line can be pulled from the trimmer head. Figure 22.

2. Spool Replacement

- a. Replace the spool when the square corners on the lugs are rounded off, reduced in size, or broken off. Figure 23.
- b. To replace the spool, follow the instructions in "Installing Spool with Line."

3. Installing Line on Spool

To replace the Line on existing Spool:

- Follow "Installing Spool w/Line," steps "a.-d." and remove any line remaining on the spool.
- Use a 40 foot length of .080" WEED EATER brand line.
- Insert 1/16" to 1/8" of the end of the line through the hole in the spool. Figure 24 . Allow no more than 1/8" line to extend inside the spool.
- Wrap the line onto the spool firmly and evenly in the direction shown by the arrow on the spool. Figure 24 .

NOTE: The line must be wrapped firmly and evenly for proper line feed.

- Follow "Installing Spool with Line," steps "e.-i."

If the line breaks off or backs up in the trimmer head, follow "Installing Spool w/Line," steps "a.-d." Pull slack in line until the line is tightly wound on the spool, leaving 4-6 inches of extended line. Continue with steps "e.-i."

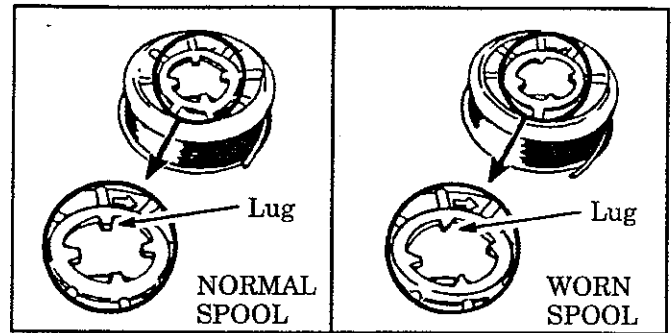

Figure 23

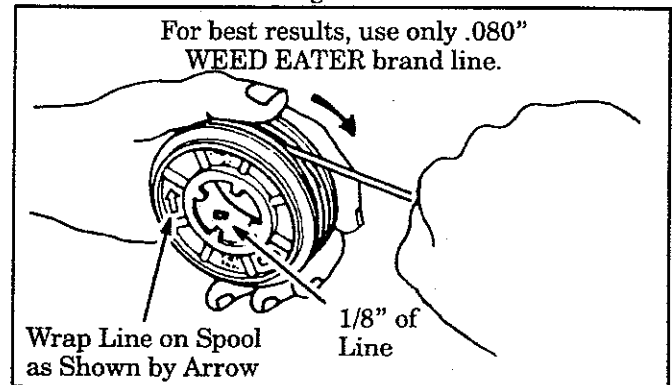

Figure 24

4. Trouble Shooting the Trimmer Head and Line

- **Does not advance or breaks while cutting:**
 - Improperly wound onto spool.
 - Line size incorrect.
 - Too little line outside head.
- **Pulls back into head:**
 - Too little line outside of head.
- **Welds onto spool:**
 - Line size incorrect.
 - Incorrect spool.
 - Crowding line against material being cut.
 - Cutting at higher speeds than necessary.

ACCESSORIES

ITEM	STOCK NO.
SAFETY FACE SHIELD	952-701601
SAFETY GLASSES	952-701645
SAFETY LEG GUARDS	952-701600
REPLACEMENT BLADE	952-701546
WEED EATER® 40:1 2-CYCLE ENGINE OIL	
--3.2 oz.	952-030133
--8 oz.	952-030128
--19.6 oz.	952-031138
FUEL CAP	952-701583
TAP-N-GO I TRIMMER HEAD	952-701574
SPOOL W/LINE	952-701523
WEED EATER NYLON CUTTING LINE (.080 Dia.)	
--80 Ft.	952-701534
--200 Ft.	952-701595
--400 Ft.	952-701590
FLEX SHAFT LUBE	952-701570
AIR FILTER	952-701614
SPARK PLUG	530-030077

GENERAL MAINTENANCE

A. MAINTENANCE SAFETY

1. Maintain the tool according to recommended procedures. Keep the cutting line at the proper length.
2. Never start the engine with the clutch shroud removed. The clutch can fly apart and cause serious injury.
3. Disconnect the spark plug before performing maintenance except for carburetor adjustments.
4. Make carburetor adjustments with the lower end supported to prevent trimmer line from contacting any object.
5. Keep others away when making carburetor adjustments.
6. Be sure trimmer head stops turning when engine idles. See "Carburetor Adjustments."
7. Replace trimmer head parts that are cracked, chipped, broken, or damaged in any other way before using the tool.
8. Use only .080" diameter WEED EATER brand line. Never use wire, rope, string, etc.
9. Use only genuine WEED EATER replacement parts as recommended.
10. Inspect the entire tool. Replace damaged parts. Check for fuel leaks and make sure all fasteners are in place and securely fastened.

B. AIR FILTER

NOTE: A dirty air filter decreases the life and performance of the engine and may increase fuel consumption and harmful emissions.

1. Clean the Air Filter:

- Always after 5 tanks of fuel or 5 hours of operation, whichever is less.
- More frequently, in dusty conditions.
 - a. Loosen the two screws on the air filter cover enough to remove the cover from engine.
 - b. Remove the air filter from the cover.
 - c. Wash filter in soap and water.
 - d. Squeeze filter dry and replace in cover.

CAUTION: Do not clean the air filter in gasoline or any other flammable solvent; doing so may create a fire hazard or produce harmful evaporative emissions.

- e. Reinstall the air filter cover, making sure the choke exit slot is placed over the choke lever. Figure 25.

CAUTION: Make sure the air filter is fitted into the corners of the cover to keep dust from entering the engine and causing engine damage.

NOTE: If replacing the air filter, see the Accessory List for proper part number.

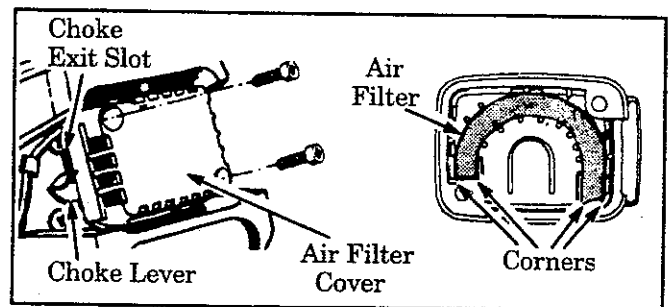

Figure 25

C. BLADE SHARPENING

▲ WARNING

Always stop the engine before sharpening a blade. The blade will continue to spin after the engine stops or after the throttle trigger has been released. Make sure the blade has stopped coasting and disconnect spark plug before performing work on blade.

1. The blade is reversible. When the cutting edge on one side becomes dull, turn the blade over. When both sides of cutting edges become dull, the blade may be resharpened.
2. Check blades for flatness periodically. Lay the blade on a flat surface and inspect the blade for flatness before sharpening. Throw away a blade that is not flat.
3. File or grind each edge in the same manner to maintain a balanced blade. Figure 26.

▲ WARNING

Always replace a blade that is bent, warped, cracked, broken, or damaged in any other way. Never attempt to straighten and re-use a damaged blade. Use only the specified replacement blade.

CAUTION: Wear protective gloves when handling or performing maintenance on the blade to help avoid injury.

▲ WARNING

To prevent the blade from cracking or flying apart after sharpening, do not file within 1/4 inch of the radii shown in Figure 26.

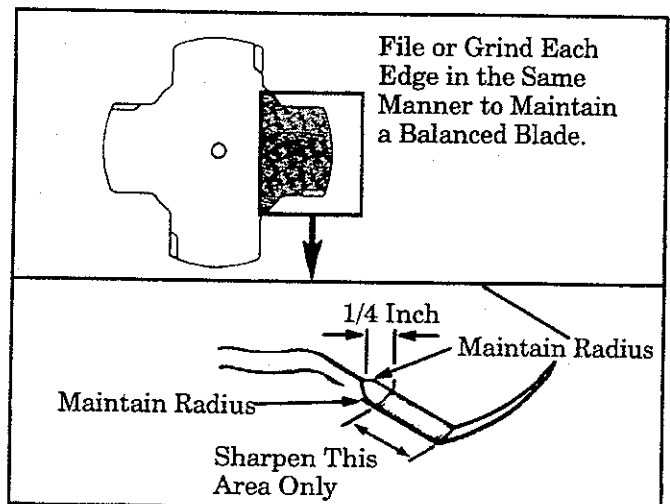

Figure 26

D. DRIVE SHAFT LUBRICATION

- Lubricate the drive shaft:
 - After each ten (10) hours of operation.
 - Before operating if the tool has been stored for 90 days or longer.

CAUTION: Lay drive shaft on a clean surface. Avoid laying the shaft on floor, ground or on any other surface that may have dirt or debris. Even after wiping shaft, grease residue can pick up dirt particles that can cause damage or premature failure.

CAUTION: Take care to avoid injury your hands and fingers with broken wires when checking for damage or wiping the drive shaft. A cloth will not prevent broken wires from puncturing or tearing your skin.

- Use following procedure:
 1. Remove the screw and nut from the throttle trigger housing. Figure 27.
 2. Hold throttle trigger away from the foam grip and remove the barrel end of the throttle cable from the throttle trigger. Figure 28.
 3. Carefully pull throttle cable out of foam grip.
 4. Loosen the nose cone screws and remove the tube from the engine.
 5. Remove drive shaft from the tube. Figure 29.
 6. Check the drive shaft for broken wires, twists or kinks, and replace if damage is found.
 7. Using a clean cloth, wipe the drive shaft thoroughly to remove any old grease. Figure 29.
 8. Apply a uniform coat of lube to the entire surface of the drive shaft.
 9. Inject the remaining contents of the container into the top of the tube.
 10. Replace drive shaft in the tube. Figure 29.

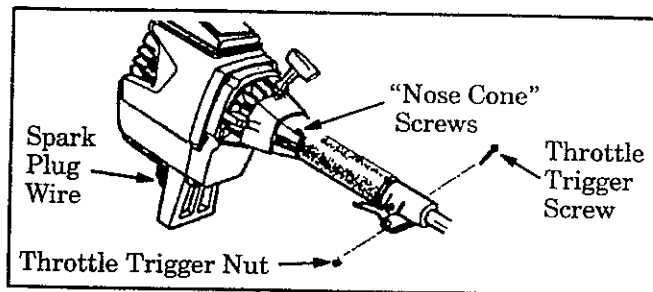

Figure 27

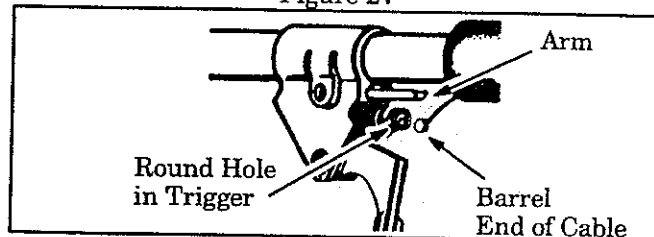

Figure 28

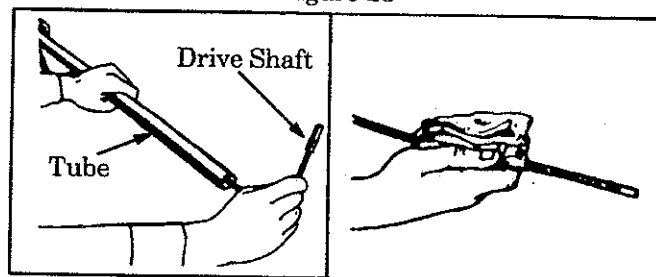

Figure 29

11. Reassemble the tube to the engine and the throttle cable to the throttle trigger housing. Tighten all screws securely.

- When ordering flex shaft lube, see the Accessory list for the proper part number.

E. CARBURETOR ADJUSTMENTS

YOUR WEED EATER PRODUCT HAS BEEN DESIGNED AND MANUFACTURED TO SPECIFICATIONS THAT REDUCE HARMFUL EMISSIONS. After your unit has been run for 5 hours, the engine has broken-in. To ensure that your unit is at peak performance and producing the least amount of harmful emissions *after* break-in, have your Authorized Service Dealer adjust your carburetor for optimum operating conditions.

NOTE: Properly adjusting the carburetor is a complicated task. Read all warnings and instructions thoroughly before starting adjustments. If you do not think that you completely understand all warnings and instructions, let your Authorized Service Dealer perform these adjustments.

▲ WARNING

Make carburetor adjustments with lower end supported to prevent the trimmer line from contacting any object. Hold tool with your hand; do not use optional shoulder strap for support.

▲ WARNING

Keep others away when making carburetor adjustments.

- Poor engine performance can be a result of other causes such as dirty air filter, carbon build-up on muffler outlets, etc. See "Trouble Shooting Chart" before proceeding with carburetor adjustments.
- For best results, it is recommended that you have an Authorized Service Dealer make all carburetor adjustments. Your dealer has the training, experience, and tools necessary to properly adjust your unit to meet our factory performance specifications. *This service is not covered by warranty.* If it becomes necessary for you to make carburetor adjustments yourself, follow the described procedures very carefully.

▲ WARNING

Serious injury to the operator and others can occur if the carburetor is not properly adjusted.

- Very small adjustments can affect engine performance. It is important to turn the screw a very small amount per adjustment and test performance before making further adjustments. Each adjustment should be no more than the width of the slot in the adjusting screw.
- This is a complicated task; it is important to follow steps in sequence as indicated.

1. TROUBLE SHOOTING SUGGESTIONS

- Engine will not continue to run at idle position. See "Idle Speed Adjustment" and "Low Speed Mixture Adjustment."
- Trimmer head continues to spin when the engine idles. See "Idle Speed Adjustment" and "Deceleration Check."
- Engine dies or hesitates when it should accelerate. See "Acceleration Check."

- Loss of cutting power which cannot be corrected by cleaning the air filter. See "High Speed Mixture Adjustment."
- Engine does not return to idle from full speed within 2 seconds. See "Deceleration Check."
- Engine will not run. See "Trouble Shooting Chart." Then, if carburetor requires adjustment, begin with "Basic Carburetor Settings."

▲ WARNING

The trimmer line will be spinning during most of this procedure. Wear your protective equipment and observe all safety instructions.

2. BASIC CARBURETOR SETTINGS

NOTE: In most cases, your engine can be made to run properly with minor carburetor adjustments. Refer to "Trouble Shooting Suggestions" in the left column for the condition you are experiencing and follow the instructions. The basic carburetor settings are provided below.

- a. Turn low speed mixture screw and high speed mixture screw (Figure 30) clockwise until they stop. *Do not turn screws until they are tight as damage to needle seats can occur.*
- b. Turn the low speed mixture and high speed mixture screws between three-quarters and one full turn counterclockwise.

3. ADJUSTING PROCEDURE

a. PREPARATION

1. Use a fresh fuel mix. See Fueling section.
2. Make sure the line extends to the length allowed by the line limiter to provide correct load on engine.
3. Start the engine. Cut grass for 3 minutes to warm engine. *The engine must be at operating temperature before carburetor adjustments can be performed correctly.*

b. IDLE SPEED ADJUSTMENT

1. Allow engine to idle.
2. Adjust idle speed screw (Figure 30) until the engine continues to run without stalling and without the trimmer head moving.
 - Turn screw clockwise to increase engine speed if the engine stalls or dies.
 - Turn screw counterclockwise to slow engine down and/or to keep trimmer head from turning.
3. Follow instructions in "Acceleration Check" and "Deceleration Check."
4. **No further adjustments are necessary if trimmer head does not turn at idle speed and performance is satisfactory.**

▲ WARNING

Recheck idle speed after each adjustment. The trimmer head must not turn at idle speed to avoid serious injury to the operator and others.

c. ACCELERATION CHECK

1. Allow engine to idle.
2. Squeeze trigger fully.
 - a.) **If performance is satisfactory**, proceed to "d. Deceleration Check."
 - b.) **If the engine does not accelerate smoothly**, turn the low speed mixture screw (Figure 30) counterclockwise a small amount (no more than the width of the slot in the adjusting screw).
3. Repeat step "2." until smooth acceleration is obtained.

NOTE: It may be necessary to repeat "Idle Speed Adjustment" through "Acceleration Check," to obtain correct adjustments.

4. Follow instructions in "Deceleration Check."

d. DECELERATION CHECK

1. Allow engine to idle, then squeeze throttle trigger fully.
2. Allow engine to run at full speed for about 1 second.
3. Release the throttle trigger to the idle position and listen to the deceleration of the engine. It must return to idle smoothly and within 1 to 2 seconds.
 - a.) **If performance is satisfactory**, proceed to step "4."
 - b.) **If the engine slowly or erratically returns to idle or idles erratically**, repeat "Idle Speed Adjustment" or continue through "Low Speed Mixture" and "High Speed Mixture Adjustments" to obtain proper deceleration.
4. Recheck idle speed.

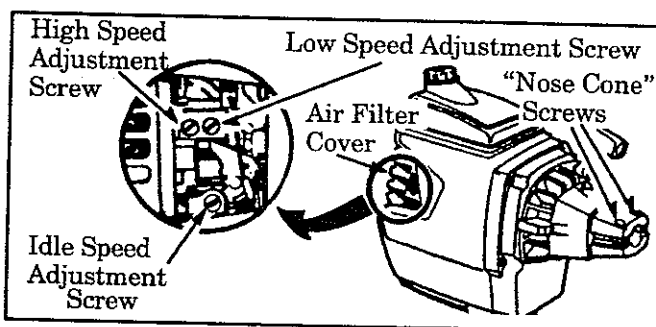

Figure 30

e. LOW SPEED MIXTURE ADJUSTMENT

1. Allow engine to idle.
2. Turn the low speed mixture screw (Figure 30) slowly clockwise until the speed starts to drop. Note this position.
3. Turn the low speed mixture screw counterclockwise until speed increases and then starts to drop again. Note this position.
4. Set the low speed mixture screw at the midpoint between the two positions.
5. Follow instructions in "Acceleration Check" and "Deceleration Check."

f. HIGH SPEED MIXTURE ADJUSTMENT

CAUTION: Do not operate engine at full throttle for prolonged periods while making high speed adjustments as damage to the engine can occur.

1. Support tube so trimmer line is off ground and will not make contact with any object.
2. Allow engine to idle, then squeeze throttle trigger fully.

NOTE: Perform steps "3." through "5." at full throttle.

3. Turn the high speed mixture screw (Figure 30) very slowly clockwise until engine speed is reduced.
4. Turn high speed mixture screw very slowly counterclockwise. Stop when the engine begins to run roughly.
5. Turn screw slowly the minimum amount clockwise until the engine runs smoothly.
6. Follow instructions in "Acceleration Check" and "Deceleration Check."

CAUTION: If the engine does not operate according to these instructions after repeating the adjusting steps, do not use the tool. Take it to your Authorized Service Dealer.

F. STARTER ROPE

- Replace a Starter Rope that breaks.

▲ DANGER

Never start engine with clutch shroud removed. The clutch will fly apart and cause serious injury.

▲ WARNING

Do not remove the pulley tab and screw or the pulley. The spring beneath the pulley is under tension and can fly out and cause serious injury. If any part of pulley housing assembly is damaged other than rope, do not use tool. Take it to your Service Dealer.

1. Disconnect spark plug wire. Figure 31.
2. Remove the screw and nut from the throttle trigger housing. Figure 31.
3. Hold throttle trigger away from foam grip and remove barrel end of throttle cable from trigger.
4. Carefully pull throttle cable out of foam grip.
5. Remove the four clutch shroud screws with the small hex wrench provided. Figure 31.
6. Separate clutch shroud from engine. Figure 31.

▲ DANGER

Use only a hand tool to remove the clutch. Do not use any type of motorized tool or strike the clutch in any way. Otherwise, the clutch will fly apart and cause serious injury.

7. Hold the "Flats" of the clutch with an adjustable wrench. Figure 32 (inset) and remove the nut counterclockwise with a 9/16" socket wrench.

NOTE: Clutch will slide off the crankshaft intact. Do not disassemble clutch.

8. Remove the cupped washer, clutch, and large flat washer as shown in Figure 32.
9. Remove pulley housing from engine. Figure 32.
10. Remove the rope retainer screw and remove any remaining rope. Figure 33.
11. Hold pulley housing as shown in Figure 34. Hand turn the pulley clockwise as far as it will go.
12. Turn the pulley counterclockwise until the pulley notch is aligned with the housing notch next to the pulley tab and screw. Figure 34.
13. Next, turn the pulley one complete turn counterclockwise until the notches are aligned again.
14. Insert hex wrench into hole formed by notches to hold pulley in position. Figure 34 (inset-right).
15. Use a 42" length of replacement rope.
16. Move away 10 feet (3 meters) from the fuel tank with the replacement rope. Use a match and melt both ends of the rope to prevent fraying.
17. Pull melted ends through a thick, clean rag while rope is still hot to obtain smooth, pointed ends.
18. Insert one end of the rope through the handle and secure with a knot. Leave a 3/16" pigtail behind the knot. Figure 34 (inset-left).
19. Insert the other end of the rope through the rope exit hole into the inside of the housing, into the pulley and up through the pulley hole. Figure 34.
20. Wrap the rope counterclockwise around the pulley ratchet and tuck loose end under the rope at the pulley hole. Figures 33 & 34. Leave a 1" tail laying flat on top of the pulley between the retainer rib and the retainer screw/post. Figure 34.
21. Reinstall the rope retainer screw into the screw post. Figure 33. Tighten until the washer is snug.

NOTE: Do not overtighten screw. Overtightening the screw can cause threads in screw post to strip out.

22. Hold the rope taut at the rope exit hole so the pulley will not move. Remove hex wrench.
23. Slowly feed rope into the pulley housing.
24. Make sure spacer is in place as shown in Figure 32. Reverse steps 1 through 10 to re-assemble.

CAUTION: When reinstalling the clutch, tighten the nut until the cupped washer is flattened against the clutch. Over or under tightening nut can cause engine damage.

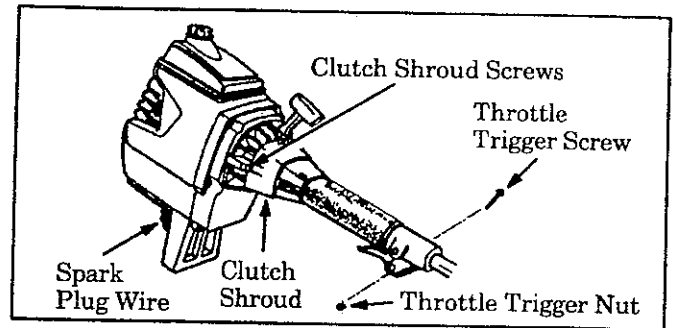

Figure 31

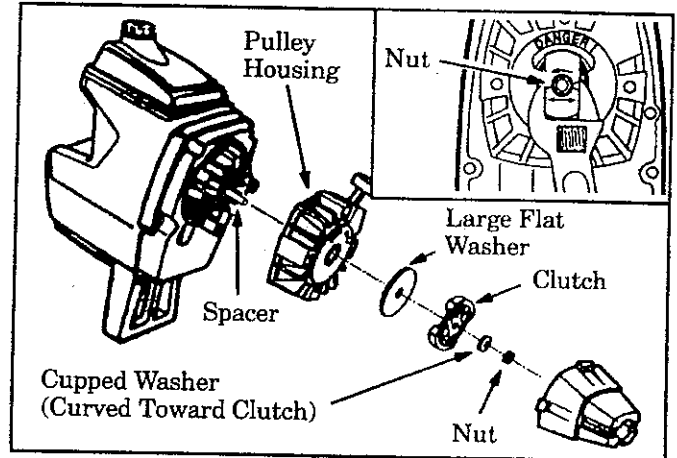

Figure 32

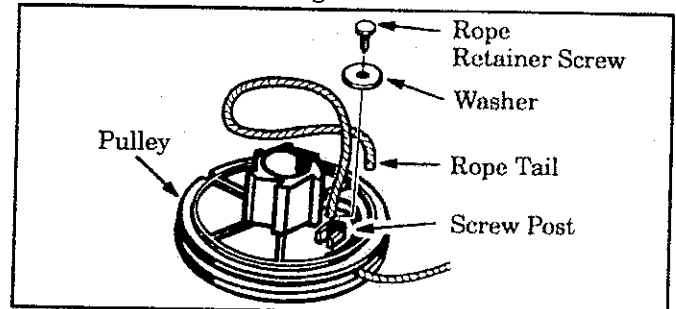

Figure 33

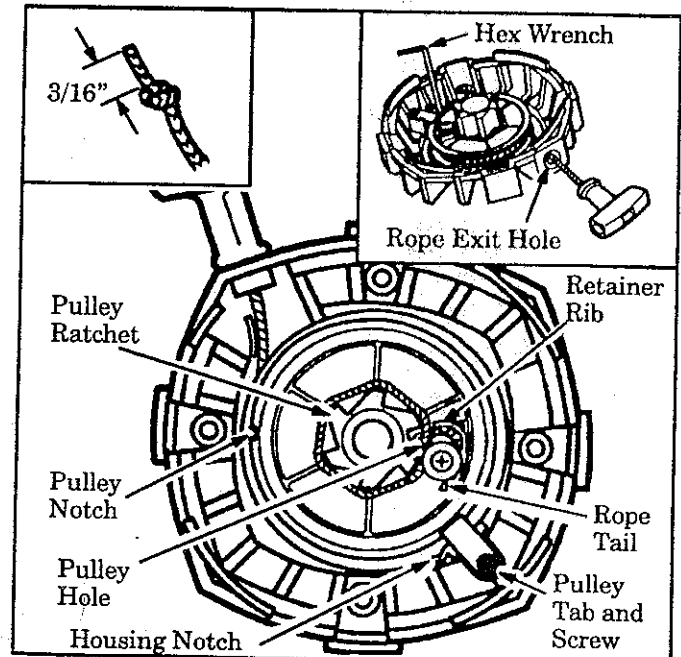

Figure 34

G. TROUBLE SHOOTING CHART

SYMPTOM	CAUSE	REMEDY
Engine will not start or will run only for a few seconds after starting.	<ol style="list-style-type: none"> 1. Fuel tank empty. 2. Engine flooded. 3. Spark plug not firing. 4. Fuel not reaching carburetor. 5. Carburetor requires adjustment. 6. None of the above. 	<ol style="list-style-type: none"> 1. Fill tank with correct fuel mixture 2. See "Starting Instructions." 3. Install new plug/check ignition system. 4. Clean fuel filter; inspect fuel line. 5. See "Carburetor Adjustments." 6. Contact your Service Dealer.
Engine will not idle properly.	<ol style="list-style-type: none"> 1. Idle speed set too fast or too slow. 2. Throttle trigger screw too tight. 3. None of the above. 	<ol style="list-style-type: none"> 1. See "Carburetor Adjustments." 2. See the "Throttle Cable" section. 3. Contact your Authorized Service Dealer.
Engine will not accelerate, lacks power, or dies under a load.	<ol style="list-style-type: none"> 1. Air filter dirty. 2. Spark plug fouled. 3. Carburetor requires adjustment. 4. Muffler outlets plugged. 5. None of the above. 	<ol style="list-style-type: none"> 1. Clean or replace air filter. 2. Clean or replace spark plug and re-gap. 3. See "Carburetor Adjustments." 4. Contact your Authorized Service Dealer. 5. Contact your Authorized Service Dealer.
Engine smokes excessively.	<ol style="list-style-type: none"> 1. Air filter dirty. 2. Fuel mixture incorrect. 3. Carburetor requires adjustment. 	<ol style="list-style-type: none"> 1. Clean or replace air filter. 2. Refuel with correct fuel mixture. 3. See "Carburetor Adjustments."
Engine runs hot.	<ol style="list-style-type: none"> 1. Fuel mixture incorrect. 2. Carburetor requires adjustment. 3. Spark plug incorrect. 4. None of the above. 	<ol style="list-style-type: none"> 1. See "Fueling Your Unit." 2. See "Carburetor Adjustments." 3. Replace with correct plug. 4. Contact your Authorized Service Dealer.
Cutting attachment turns at idle speed.	<ol style="list-style-type: none"> 1. Carburetor requires adjustment. 2. Throttle cable binding. 3. Clutch requires repair. 	<ol style="list-style-type: none"> 1. See "Carburetor Adjustments." 2. Contact your Authorized Service Dealer. 3. Contact your Authorized Service Dealer.
Cutting Head stops under a load or does not turn when engine is accelerated.	<ol style="list-style-type: none"> 1. Drive shaft not engaged. 2. Drive shaft broken. 3. Carburetor requires adjustments. 4. Clutch requires repair. 5. None of the above. 	<ol style="list-style-type: none"> 1. See "Assembly," "Tube." 2. Contact your Authorized Service Dealer. 3. See "Carburetor Adjustments." 4. Contact your Authorized Service Dealer. 5. Contact your Authorized Service Dealer.
Line does not advance or breaks while cutting.	<ol style="list-style-type: none"> 1. Line improperly routed in head. 2. Line improperly wound onto spool. 3. Line size incorrect. 4. Too little line outside head. 5. Dirt accumulated on cover cut-outs. 	<ol style="list-style-type: none"> 1. Remove cover. Check line routing. 2. Rewind line tightly and evenly. 3. Use only .080" WEED EATER brand line. 4. Remove cover. Pull 4" of line to outside. 5. Clean cover cut-outs.
Line welds on spool.	<ol style="list-style-type: none"> 1. Line size incorrect. 2. Incorrect spool. 3. Crowding line against material being cut. 4. Cutting at higher speed than necessary. 	<ol style="list-style-type: none"> 1. Use only .080" WEED EATER brand line. 2. Use proper spool. 3. Cut with tip of line. 4. Reduce cutting speed.
Line releases continuously.	<ol style="list-style-type: none"> 1. Line improperly routed in head. 2. Balance arm broken. 3. Line size incorrect. 	<ol style="list-style-type: none"> 1. Remove cover. Check line routing. 2. Replace head. 3. Use only .080" WEED EATER brand line.
Line usage is excessive.	<ol style="list-style-type: none"> 1. Line improperly routed in head. 2. Line size incorrect. 3. Cutting at high speed around hard objects. 4. Crowding line against material being cut. 	<ol style="list-style-type: none"> 1. Remove cover. Check line routing. 2. Use only .080" WEED EATER brand line. 3. Reduce speed around hard objects. 4. Cut with tip of line.
Line pulls back into head.	<ol style="list-style-type: none"> 1. Too little line outside of head. 	<ol style="list-style-type: none"> 1. Remove cover. Pull 4" of line to outside.

CUSTOMER ASSISTANCE ? call 1-800-554-6723

One of the most important priorities at POULAN/WEED EATER is customer satisfaction, especially *after* the sale. Your product has been expertly engineered and carefully manufactured to rigid quality standards to provide you with optimum performance and maximum operational lifetime. As with all mechanical products, however, making adjustments or replacing parts may be necessary during the life of your unit.

Because customer satisfaction is a major priority, POULAN/WEED EATER has established a special, toll free Customer Assistance Service to assist you with any after-the-sale needs. Whether you need a replacement part, an accessory, the name of your nearest sales or service dealer, or just need help in assembling your unit, our customer service representatives will be available to answer your questions.

When calling our Customer Assistance Service, please be prepared to give the description of the unit, the model number, serial number, and, if ordering parts, the part number or description of each part. Call 1-800-554-6723. Our representatives will be glad to help.

FOR SERVICE OR REPLACEMENT PARTS:

1. Consult your dealer/place of purchase.
2. Consult the yellow pages of your phone directory for the name of the nearest POULAN/WEED EATER Master Service Dealer (under "saws" for Chain Saws or under "lawnmowers" for Trimmers, Brushcutters, and Blowers).

NOTE: POULAN/WEED EATER Division provides parts and service through its authorized distributors and dealers; therefore, all requests for parts and service should be directed to your local dealer(s). The philosophy of POULAN/WEED EATER Division is to continually improve all of its products. If the operating characteristics or the appearance of your product differs from those described in this Operator's Manual, please contact your local POULAN/WEED EATER Dealer for updated information and assistance.

POULAN/WEED EATER
DIVISION OF WCI OUTDOOR PRODUCTS, INC.
Shreveport, Louisiana 71129 U.S.A.

©1994 Poulan/Weed Eater Division WCI Outdoor Products, Inc.