

BELKIN[®]



TuneCommand[™] for iPod[®]

Wirelessly control your tunes anywhere

EN

User Manual

F8Z024ea





Introduction

Designed to let you roam and play your tunes from virtually anywhere in your home, the TuneCommand for iPod from Belkin delivers the flexibility and convenience that iPod users desire. Using wireless radio frequency technology, TuneCommand works from up to 120 ft. / 37 m. away from your stereo. Please review this User Manual carefully so that you can be sure to get the most from your TuneCommand.



EN

What's in the Box

TuneCommand Receiver for iPod

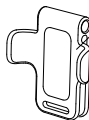
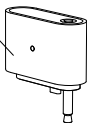

Multi-Clip



Surface-Mount Hook

TuneCommand Remote Transmitter

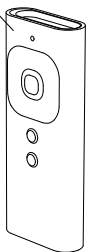

Battery (model CR 2032)



Lanyard Adjuster



Lanyard

Operating Instructions

STEP 1 - TuneCommand Receiver Setup

1. Power on your iPod. Then, plug the TuneCommand Receiver into the iPod device's remote/headphone connector (Fig. 1). The Receiver powers on automatically and its green light blinks three times.

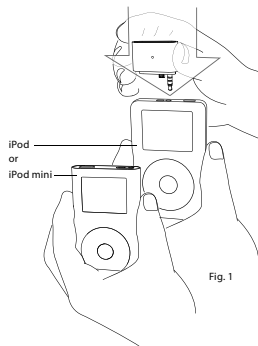
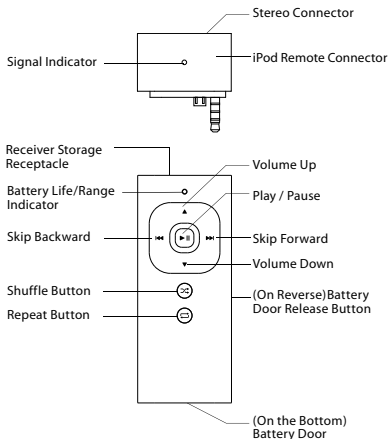

EN

Operating Instructions

STEP 2 - TuneCommand Remote Setup

1. Turn your Remote with the buttons facing down. Press the release button to open the battery tray, and gently pull it out of the housing until it stops (Fig. 2). Please do not force the battery tray completely out of the housing.
2. Insert the battery with the (+) side facing up (Fig. 3) and push the battery cover back into the Remote until the button snaps back into place.
3. Now press any of the Remote's buttons for the TuneCommand Remote and Receiver to pair up. The green lights on the Receiver and the Remote blink when the first button press command from the Remote reaches the Receiver correctly.

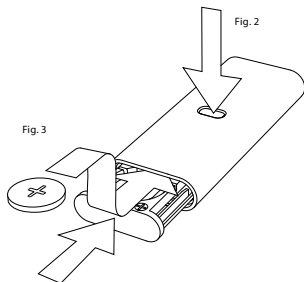



Operating Instructions

STEP 2 - TuneCommand Remote Setup

Use the stereo connector on top of the TuneCommand Receiver to connect your iPod to your stereo system. As an alternative, you can connect to your stereo system via the iPod device's docking cradle and its built-in line-out port.

You can now use your TuneCommand Remote handset to control the iPod device's play/pause, skip forward, skip backward, and volume up/down functions. In addition, you can conveniently control the shuffle and repeat functions, using the two small round buttons. Each press of a button advances the setting to the next stage. When used with the iPod photo, TuneCommand lets you scroll through your slideshows or presentations—wirelessly.

The shuffle key  advances the iPod device's shuffle settings as follows:
Shuffle off > Shuffle songs > Shuffle albums.

The repeat button  advances the iPod device's repeat settings like this:
Repeat off > Repeat one > Repeat all.

Follow the icons on the iPod device's screen to see the current settings, represented by small icons on the upper right, below the battery status indicator.

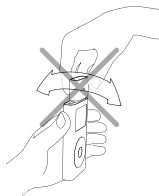
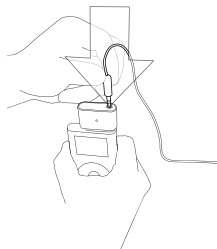

NOTE: To avoid damage to the Mounting Port, do not move the Receiver back and forth.

EN

Operating Instructions

LED Chart

Every time you push a button on the Remote, the green lights on the Remote and the Receiver blink, indicating that the signal has been received correctly.

If the Remote and the Receiver are too far apart to communicate, the light on the Remote blinks amber (after a short delay) instead of green when you press a button. The light on the Receiver will not blink.

The Remote's battery level is automatically checked after every button press. If the battery level is low, the Remote's red light will blink, following the green or amber blink. The low battery should be replaced soon. The TuneCommand will continue to function normally until the battery is exhausted.

Storage Option

The TuneCommand Remote features a convenient Mounting Port for storing the TuneCommand Receiver when not in use—ensuring you can always easily find it again.

Green Received the signal

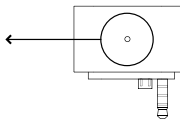

Green The receiver receives the signal

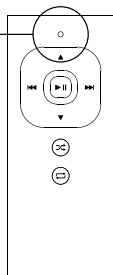

Amber Out of range

Red The battery life is running out



Operating Instructions

Using the Multi-Clip

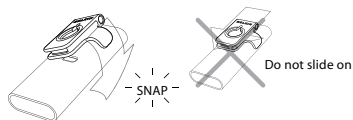

Snap the clip on the Transmitter



How to clip on the belt

Adhesive backing
attaches to
smooth surface

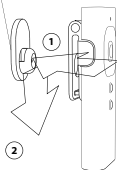

How to use with the surface-mount hook

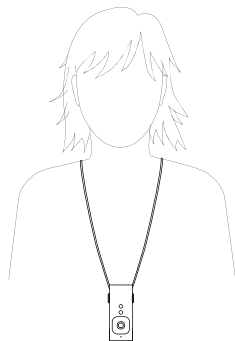

How to snap on the clip when using the lanyard (the clip is to be used upside down in this case)

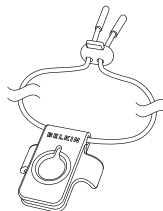

How to use the lanyard and lanyard adjuster

EN

Troubleshooting

Receiver is not powering on when plugged into the iPod.

Remove the Receiver and reinstall into the top of your iPod. Ensure your iPod is charged or connected to power, and turned on.

Remote handset is not powering on.

Ensure that the Remote battery is inserted correctly, with the (+) facing up, that the battery tray is fully pushed in, and the release button is snapped back into position.

After connecting the Receiver and Remote, there is no sound.

- Select a song on the iPod and press "PLAY".
- Make sure the audio cable is correctly plugged into the TuneCommand Receiver and the back of the stereo system (when using an audio cable).
- When connected to a stereo system, ensure the stereo system is set to the correct input channel.
- Make sure the iPod and stereo system are powered on.
- Repeat STEP 1 and STEP 2 of the setup section.

Specifications

Operating Range: Up to 120 ft. / 37 m.

Transmission Method: Radio frequency

Frequency: 2.44GHz

Remote Battery: CR2032 3V

Remote Dimensions: 2.75" x 1.25" x 0.5"

(not including belt clip; 0.75" max depth including belt clip)

Remote Weight (including battery): 0.8oz. (33.9g)

Receiver Dimensions: 1.57" x 1.49" x 0.54"

Receiver Weight: 0.37oz. (10.6g)

Clip/Surface Mount/Lanyard: 0.47oz. (13.2g)

EN



Information

Belkin Corporation Limited 3-Year Product Warranty

Belkin Corporation warrants this product against defects in materials and workmanship for three years. If a defect is discovered, Belkin will, at its option, repair or replace the product at no charge provided it is returned during the warranty period, with transportation charges prepaid, to the authorized Belkin dealer from whom you purchased the product. Proof of purchase may be required. This warranty does not apply if the product has been damaged by accident, abuse, misuse, or misapplication; if the product has been modified without the written permission of Belkin; or if any Belkin serial number has been removed or defaced.

THE WARRANTY AND REMEDIES SET FORTH ABOVE ARE EXCLUSIVE IN LIEU OF ALL OTHERS, WHETHER ORAL OR WRITTEN, EXPRESSED OR IMPLIED. BELKIN SPECIFICALLY DISCLAIMS ANY AND ALL IMPLIED WARRANTIES, INCLUDING, WITHOUT LIMITATION, WARRANTIES OF MERCHANTABILITY AND FITNESS FOR A PARTICULAR PURPOSE.



No Belkin dealer, agent, or employee is authorized to make any modification, extension, or addition to this warranty.



BELKIN IS NOT RESPONSIBLE FOR SPECIAL, INCIDENTAL, OR CONSEQUENTIAL DAMAGES RESULTING FROM ANY BREACH OF WARRANTY, OR ANY OTHER LEGAL THEORY, INCLUDING BUT NOT LIMITED TO, LOST PROFITS, DOWNTIME, GOODWILL, DAMAGE TO OR REPROGRAMMING OR REPRODUCING, ANY PROGRAM OR DATA STORED IN OR USED WITH BELKIN PRODUCTS.

Some states do not allow the exclusion or limitation of incidental or consequential damages or exclusion of implied warranties, so the above limitations or exclusions may not apply to you. This warranty gives you specific legal rights, and you may also have other rights that vary from state to state.



FCC Statement

NOTE: This equipment has been tested and found to comply with the limits for a Class B digital device, pursuant to part 15 of the FCC Rules. These limits are designed to provide reasonable protection against harmful interference in a residential installation. This equipment generates, uses, and can radiate radio frequency energy and, if not installed and used in accordance with the instructions, may cause harmful interference to radio communications. However, there is no guarantee that interference will not occur in a particular installation. If this equipment does cause harmful interference to radio or television reception, which can be determined by turning the equipment off and on, the user is encouraged to try to correct the interference by one of the following measures:

- Reorient or relocate the receiving antenna.
- Increase the separation between the equipment and receiver.
- Connect the equipment into an outlet on a circuit different from that which the receiver is connected.
- Consult the dealer or an experienced radio/TV technician for help.

CE FC  N10117

EN





BELKIN®

www.belkin.com

Belkin Ltd.
Express Business Park, Shipton Way
Rushden, NN10 6GL, United Kingdom
+44 (0) 1933 35 2000
+44 (0) 1933 31 2000 fax

Belkin B.V.
Boeing Avenue 333
1119 PH Schiphol-Rijk, The Netherlands
+31 (0) 20 654 7300
+31 (0) 20 654 7349 fax

Belkin GmbH
Hanebergstraße 2,
80637 Munich, Germany
+49 (0) 89 143405 0
+49 (0) 89 143405 100 fax

Belkin SAS
130 rue de Silly
92100 Boulogne-Billancourt, France
+33 (0) 1 41 03 14 40
+33 (0) 1 41 31 01 72 fax

Belkin Tech Support
Europe: 00 800 223 55 460

© 2005 Belkin Corporation. All rights reserved.
All trade names are registered trademarks of respective manufacturers listed.
iPod is a trademark of Apple Computer, Inc., registered in the U.S. and other countries.

F8Z024ea

P74852ea