

EN

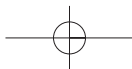

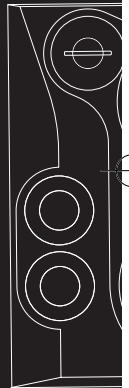

THOMSON multimedia
46/47 quai A. Le Gallo
92648 Boulogne Cedex
FRANCE
RCS nanterre
B 322 019 464
55678710
www.thomson-multimedia.com

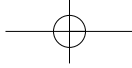

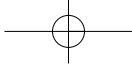

THOMSON

u
s
e
r
m
a
n
u
a
l

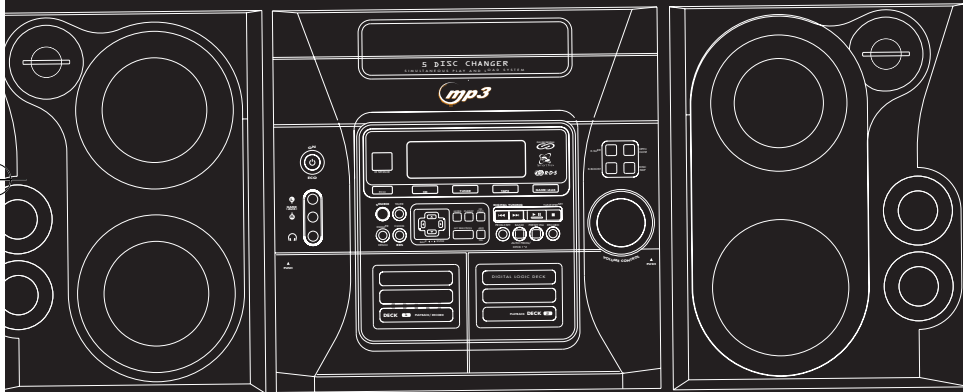

MS6000



Safety Information

EN

Thomson Information

CAUTION!

Invisible laser radiation when open. Avoid exposure to beam. Class 1 laser product. This system must be opened only by qualified technicians to prevent accidents caused by the laser beam.

LASER $\lambda = 780 \text{ nm}$, $P_{\text{max}} = 5 \text{ mW}$

Rating Information: At bottom/rear of the unit.
This unit comply with the existing requirements



In accordance with the rating plate of the unit, this unit complies with current standards concerning electrical safety and electromagnetic compatibility.



Please respect the environment Before throwing any batteries away, consult your distributor who may be able to take them back for specific recycling.



Have a Blast- Just Not in Your Eardrums
Make sure you turn down the volume on the unit before you put on headphones. Increase the volume to the desired level only after headphone are in place.

ADVARSEL!
USYNLIG LASERSTRÅLING VED ÅBNING NÅR SIKKERHEDSAFBRYDERE ER UDE AF FUNKTION. UNGDÅ UDSÆTTELSE FOR STRÅLING.
VORSICHT!
UNSICHTBARE LASERSTRALUNG WENN ABDECKUNG GEÖFFNET UND SICHERHEITSVERRIEGELUNG ÜBERBRÜCKT.
NICHT DEM LASERSTRAHL AUSSETZEN!

CAUTION – INVISIBLE LASER RADIATION
WHEN OPEN AND INTERLOCKS FAILED OR DEFEATED. AVOID EXPOSURE TO BEAM.
ATTENTION – RAYONNEMENT LASER INVISIBLE
DANGEREUX EN CAS D'OUVERTURE ET LORSQUE LA SECURITE EST NEUTRALISEE.
EXPOSITION DANGEREUSE AU FAISCEAU.



CLASS 1 LASER PRODUCT
LASER KLASSE 1
APPAREIL A LASER DE CLASSE 1
LUOKAN 1 LASERLAITE
KLASS 1 LASERAPPARAT

VARING-
OSYNLIG LASERSTRÅLING NÅR DENNA DEL ÅR ÖPPNAD OCH SPÄRRAN ÅR URKOPPLADE. BETRAKTA EJ STRÅLEN.
VARO!
AVATTAESSA JA SOIJALUKITUS OHITETTAESSA OLET ALTIINA NÄKYMÄTTÖMÄLLE.
LASERSÄTEILYLLE ÄLÄ KATSO SÄTEESEEN.

For UK Only

CONNECT THE MAIN LEAD INTO A MAINS POWER SOCKET

POWER SUPPLY **230V**. It must not be connected to D.C. mains.

Note; The mains lead of the set is fitted with a molded plug. If the mains socket are not compatible or if for any reason the plug is removed please follow the directions below. The molded plug cannot be rewired and if removed must be disposed of safely.

DO NOT under any circumstances plug the severed plug into any mains socket as this could result in electric shock.

Important: If the plug is removed, rewire the new plug as follow:

The wires in the mains plug are colored in accordance to the following code:

BLUE = NEUTRAL/BROWN = LIVE

If the colors of the wires in the mains lead of this apparatus may not correspond with the colored markings identifying the terminals in your plug, proceed as follows:

BLUE wire to the terminal coded N (Neutral) or colored black.

BROWN wire to the terminal coded L (Live) or colored red.

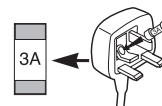

DO NOT make any connection to the terminal in the plug which is marked by the letter E or by the earth symbol or colored green or green and yellow.



A fused plug must be fitted with a 3A fuse approved by ASTA or BS1362 and fuse covers must be always be securely replaced. If you set does not work, the fuse may be blown.

Safety Information

EN

 <p>THE LIGHTNING FLASH AND ARROW-HEAD WITHIN THE TRIANGLE IS A WARNING SIGN ALERTING YOU OF "DANGEROUS VOLTAGE" INSIDE THE PRODUCT.</p>	<p>CAUTION RISK OF ELECTRIC SHOCK DO NOT OPEN</p> <p>CAUTION: TO REDUCE THE RISK OF ELECTRIC SHOCK, DO NOT REMOVE COVER (OR BACK). NO USER-SERVICEABLE PARTS INSIDE. REFER SERVICING TO QUALIFIED SERVICE PERSONNEL.</p>	 <p>THE EXCLAMATION POINT WITHIN THE TRIANGLE IS A WARNING SIGN ALERTING YOU OF IMPORTANT INSTRUCTIONS ACCOMPANYING THE PRODUCT.</p>
SEE MARKING ON BOTTOM / BACK OF PRODUCT		

WARNING: TO PREVENT FIRE OR ELECTRICAL SHOCK HAZARD, DO NOT EXPOSE THIS PRODUCT TO RAIN OR MOISTURE.

The Thomson Multimedia Pack

The Thomson Multimedia Pack is an offer that includes the MusicMatch jukebox Music Management software, to be installed on your PC.

Thanks to this software, you will enter the digital music world and benefit from numerous features :

- MusicMatch Jukebox allows to compress music files into mp3 & WMA* (Windows Media Audio) formats recorded from your audio CDs, and to keep them on your PC. You could also use other audio sources for your recordings (vynil, tape),
- It makes the search and download of internet music easier,
- It allows the management of your compressed music and the creation of your own playlists,
- The Jukebox is a true audio player installed on your PC,
- It gives access to thousands of net radios today available on the web.

You can listen and share the compressed music files played by MusicMatch jukebox directly on your Thomson audio system, and thus to enjoy the digital music with your system's rich features.

- Simply plug the 3.5mm PC-pin end of the cable into the speaker or headphone jack of your PC, and insert the twin RCA ends to the @/AUX connection of your Thomson audio system.
- Select the audio source on your system with the switch located on @ AUX.

You can download music files encoded in mp3 or WMA* from several internet sites.

Here a few sites to discover :

- www.real.com
- www.mp3.com
- www.mpeg.org
- www.windowsmedia.com

* Windows Media is a registered trademark of Microsoft Corporation.

Table of Contents

EN

Safety Information The Thomson Multimedia Pack

Getting Started

Unpacking the System	2
Back View	2
Installation	2

Controls & Indicators

Main Unit	3
Remote Control	4
Installing Batteries	5

Display5

Settings

Showing the Demonstration	6
Display Clock/Time	6
Setting the Clock	6
Setting the Timer	6
Activating the Timer	6
Adjusting the Display	7
Brightness	7
Sleep Mode	7

Sound Features

Using Preset Equalizer Curves	7
Creating a Custom Curve	7
Bass Boost	7
Muting Audio	7
X-Surround	7

CD and mp3 Playback

Notes on CD-R/RW Disc	8
Loading Discs	8
Play/Pause Playback	8
Play and Load Simultaneously	8
Stop Playback	8
Skipping Discs	8
Skipping Tracks	8
Searching Through a CD	8
Random Playback	8
Sampling Tracks	8
Repeat	8
CD Display	9
Setting Up a CD Program	9
Playing a Program List	9
Displaying the Program List	9
Deleting Program List	9
The MusicMatch Jukebox	10
File Navigation	10
mp3 format	11
Playing a mp3 disc	11
Track Information	11
Additional SmartTrax Features	12
Mode	13
Playlist	13
My Selection	13
Selecting Titles to be Placed into My Selection	13
View My Selection	13
Deleting Titles from My Selection	13
Delete All Titles from My Selection	13

Tuner

Selecting Tuner	14
Tuning to a Station	14
Using Presets	14
Auto Preset Program (for FM only)	14
Manually Setting Presets	14
Suppressing Stereo Signal	14
Tuning to an RDS Station	14
Displaying RDS Station Information	14
Searching by Program Type (PTY)	14

Tape Player

Playing a Tape	15
Continuous Play	15
Recording	15
From Tuner	15
From CD	15
Tape to Tape	15
From an Auxiliary Input	15

Troubleshooting Tips

.....	16
-------	----

Maintenance

Cleaning	17
CD Player	17
Tape Player	17
Handling CDs	17
Cleaning CDs	17
CD Lens Care	17

More Information18

Safety Precautions	18
Important Battery Information	18
Headset Safety	18
Don't Infringe	18
Technical Specification	18

Getting Started

Unpacking the system:

You should have the following:

- one main unit (with 2 main speakers);
- one remote control;
- one AM loop antenna;
- one FM antenna wire
- one user's guide;
- One Thomson Warranty Card

Back View

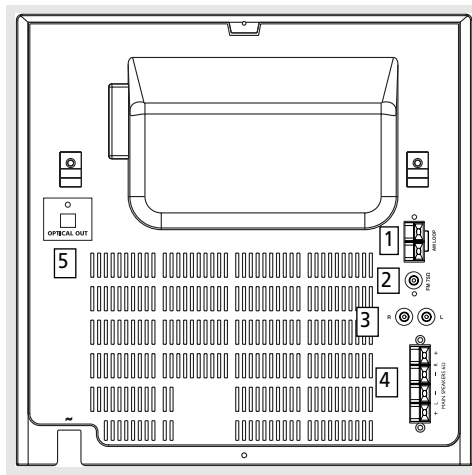

1. AM Loop Antenna Jacks
2. FM Antenna Connector
3. Aux out Connectors
4. Main Speaker Jacks
5. Optical Out Connector

Using the FM and AM Antennas

Before you use your audio system, you'll want to make sure both the FM and AM antennas are positioned properly. Connect the FM antenna to the FM connector on the back of the unit. Uncoil it, making sure it is fully extended. (you may even want to tape it to the wall behind the unit if possible. The higher the better.)

You'll also need to connect the AM antenna loop to the back of the unit if you listen to AM stations. Rotate the AM loop antenna for better reception.

Connecting the Speakers

Match the red wire (on the left speaker) to red terminal for the left speaker (L) on the back of the unit and the black wire (on the left speaker) to the black terminal for left speaker (L). Follow the same procedure to connect the right (R) speaker.

Antenna and Speaker Wire Connection

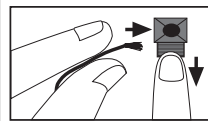

Push terminal tab down to insert wire.

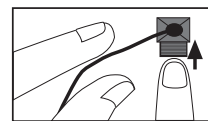

Release tab to lock wire in the terminal.

NOTE: Make sure the insulation is completely removed from the ends of the Antenna and speaker wires at all connection points.

Installation

To ensure sufficient ventilation, keep the spacings shown below free from other surfaces:

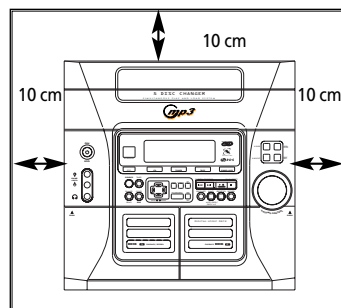

Front View

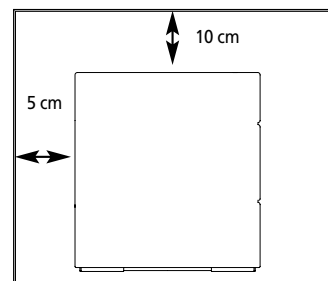

Side View

EN

Controls and Indicators

EN

Main Unit



ON/ECO — keep pressing briefly to enter ECO (power saving, without clock display) mode.

Tip: In **STANDBY** mode (press **ON/ECO** off), the system displays the time. Press **ON/ECO** to turn the system on in the previously used mode. Press **SOURCE** to select the corresponding mode. Look at the display icons to identify the current mode.

GAME •AUX - Jack for auxiliary connection.

PHONES — Jack for connecting headphones.

SOURCE — Selects CD player/ tuner/ tape player/ external source.

DIMMER / DEMO — Turns the feature demonstration on or off; adjusts display contrast.

TIMER — Enters timer setting mode; turns timer on/off.

CLOCK/RDS — Shows clock time and enters clock setting mode; shows RDS information in Tuner Mode (FM).

▲ **UP** - *mp3 Playback* - selects previous mp3 title.

▼ **DOWN** - *mp3 Playback* - selects next mp3 title.

◀ **BACK** - Goes up one folder from current folder.

▶ **ENTER** - enters current folder and show the first title from current folder.

MODE (For mp3 discs with SmartTrax) - selects between SmartTrax mode and normal mp3 mode.

PLAYLIST (For mp3 discs with SmartTrax) - access Playlist folders.

CD INFO - In mp3 mode - Toggles ID3 TAG. In CD mode - Selects the choice of displaying Track elapsed time, track remaining time, CD elapse time or CD remaining time.

In Tuner mode - toggles between FM stereo and mono sound.

MY SELECTION (For mp3 discs with SmartTrax) - access My Selection folder in mp3 mode if the SmartTrax feature is available.

ADD / DEL (For mp3 discs with SmartTrax) - Adds and deletes titles to/from My Selection.

DIGITAL TUNING (SKIP BACKWARD) — Decrements radio frequency, preset down, goes to the previous CD track or setting option; rewind tape or preset down.

option; rewind tape or preset down.

DIGITAL TUNING (SKIP FORWARD) — Increments radio frequency, preset up, goes to the next CD track or setting option; fast forward tape or preset up.

▶ **PLAY / PAUSE** — Plays or pauses CD and tape operation.

TUNE•PRESET — Stops CD track and tape operations, Sets tune or preset mode.

PROG•SET - Enters program mode for CD and Tuner; Applies new settings for Clock and Timer modes.

In Tape mode - resets tape counter.

BAND /AUTO PROG./DECK 1•2 — Changes among tuner bands; enters auto-preset program in FM mode; switches between deck 1 and 2 on cassette player.

PRESET EQ — selects among the different EQ modes.

RECORD - Starts tape recording.

X-SURR. — Turns X-Surround on or off.

B. BOOST — Turns bass boost on or off.

OPEN/CLOSE — Opens or closes the disc tray.

DISC SKIP — Skips to the next CD in the tray.

VOLUME — Increases/ decreases volume.

Controls and Indicators

Remote Control

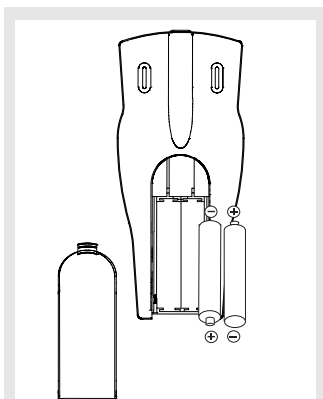
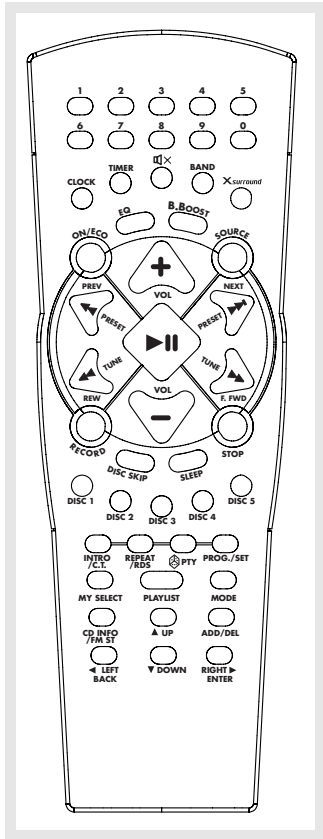

Battery Size:
"AAA" or "UM-4" or "R03"

- NUMERIC KEYS** - Accesses different tracks directly for normal audio CDs.
CLOCK - Enters clock setting mode.
TIMER - Enters timer setting mode; Activates and deactivates timer.
MUTE - mutes sound.
BAND - *In Tuner mode* - Selects radio band.
X SURROUND - Activates X Surround.
ON•ECO — keep pressing briefly STANDBY mode to enter ECO (power saving, without clock display) mode.
EQ - Selects among different equalizer preset (Flat, Rock, Pop, Jazz, Classic and Custom).
B. BOOST - Turns on/off enhancement of the bass sound.
SOURCE - Selects Tuner, Tape, CD or Aux.
VOL+ or VOL- — Increases/ decreases volume.
▶||PLAY/PAUSE — Plays and Pauses the CD or tape.
PRESET / PREV - *In programming mode* - Goes to the previous preset location; *In CD mode* - Goes to the previous CD track, searches backward through CD.
PRESET / NEXT - *In programming mode* - Goes to the next preset location; *In CD mode* - Goes to the next CD track, searches forward through CD.
TUNE / REW - *In Tuner mode* - Moves back in radio frequency. *In Tape mode* - rewinds tape.
TUNE / FWD - *In Tuner mode* - Moves forward in radio frequency. *In Tape mode* - fast forwards tape.
RECORD — Starts tape recording.
STOP — Stops CD and tape playback.
DISC SKIP — Skips to next CD.
SLEEP - selects the time interval in minutes before the unit turns off.
DISC 1, 2, 3, 4, 5 - Directly selects and plays disc.
INTRO•CT — Turns INTRO mode on or off to play the first 10 seconds of each track, shows RDS time.
REPEAT•RDS — Repeats a track, CD, or all CDs. When the radio is active, displays RDS information.
/PTY — Turns on/off random listening, selects search by program type in tune mode.
PROG./SET - Enters program mode for CD and Tuner; Applies new settings for Clock and Timer modes.
MY SELECT (*mp3 disc with SmartTrax only*) - Access My Selection folder in Smart Trax.
PLAYLIST (*mp3 disc with SmartTrax only*) - Activates playlist operation.
MODE (*mp3 disc with SmartTrax only*) - Selects between SmartTrax mode and normal mp3 mode.
CD INFO / FM ST - *In mp3 mode* - Toggles ID3 TAG
In CD mode - Selects the choice of displaying Track elapsed time, track remaining time, CD elapse time or CD remaining time.
In Tuner mode - Toggles between FM stereo and mono.
UP (*mp3 only*) - selects previous mp3 title.
DOWN (*mp3 only*) - selects next mp3 title.
ADD/DEL (*mp3 disc with SmartTrax only*) - Adds and deletes mp3 songs or folder to/from My Selection.
LEFT/BACK (*mp3 only*) - Goes up one folder from current folder.
RIGHT /ENTER (*mp3 only*) - enters current folder and show the first title from current folder.

EN

Controls and Indicators

EN

Installing Batteries

The remote control must be inserted with 2 "AAA" or "R3" or "UM 4" batteries prior to use. Follow the steps below to ensure correct installation.

1. Open the battery compartment door (located at the back of the remote control) by sliding the cover out.

2. Before inserting the batteries, observe the polarities (that is, + and -) of the battery then relate the polarities to the engraved diagram inside the battery compartment. Now insert the batteries.

3. After installation of the batteries, place the lid to cover the batteries. Lightly push it closed with a snap.

Display

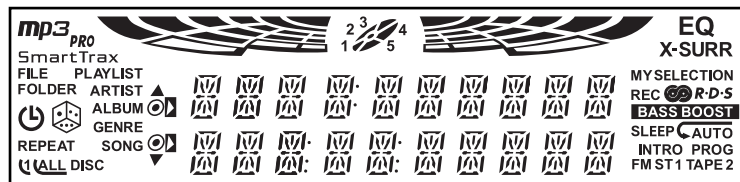

DISC 1, 2, 3, 4, 5 - The corresponding disc number is displayed to indicate which disc tray is loaded. The number will flash during playback to show which CD is currently playing.

mp3 / mp3 PRO / SmartTrax - Indicates the CD format.

FILE / FOLDER - Indicates the format of the current title for a mp3 CD.

PLAYLIST - On a SmartTrax CD, the icon indicates the current titles are from additional playlists on the CD.

ARTIST / ALBUM / GENRE / SONG - On a SmartTrax CD, these icons indicate the folder you are in after entering from the root directory.

- The timer is activated.

- Random playback feature is activated in CD mode.

REPEAT 1 / REPEAT ALL DISC / REPEAT 1 DISC - In CD mode, the corresponding icons are displayed to indicate the repeat option that is selected.

REPEAT 1 - repeat current track.

REPEAT ALL DISC - repeat all discs.

REPEAT 1 DISC - repeat current disc.

- When in SmartTrax CD mode, the icon indicates the title you are currently at is bookmarked into My Selection folder. If the icon appears in front of a folder, it indicates that certain titles in that folder is bookmarked into My Selection.

- When in SmartTrax CD mode, the icon indicates all the items in the current folder are selected into My Selection folder.

- When in mp3 CD mode, the arrow indicates your current position.

EQ - Indicates one of the preset equalizer is activated.

X-SURR - Indicates x-surround sound is activated.

MY SELECTION - On a SmartTrax CD, the icon indicates you are currently in My Selection folder.

REC - Indicates recording is activated in tape mode.

RDS - RDS signal detected in tuner mode.

BASS BOOST - Indicates Bass Boost is activated.

SLEEP - Indicates sleep is activated.

INTRO - Indicates the Intro feature is activated in CD playback mode.

PROG - In Tuner mode, the icon is displayed when in preset mode. In CD mode, the icon is displayed when playing a CD program.

FM ST - In Tuner mode, the icon indicates the radio station is playing with FM stereo sound.

TAPE 1 / TAPE 2 - Indicates the tape deck you are currently playing.

Settings

Showing the Demonstration

Magic demonstration is available in all modes except for when timer is on or sleep mode is activated. Press **DIMMER/DEMO** to turn on/off magic demonstration mode. The demonstration scrolls through all display operations.

Setting Clock / Timer

Setting the Clock

1. Press and hold **CLOCK/RDS** until the hour flashes on the display. **CLOCK SET** will show on the second row of the display to indicate you are currently in clock setting mode.

0:00
CLOCK SET

2. Press **DIGITAL TUNING** **◀◀** or **▶▶** on the main unit or **PRESET / PREV** **◀◀** or **PRESET / NEXT** **▶▶** on the remote control to select the hour.
3. Press **CLOCK/RDS** to shift to minute digits.
4. Follow step 2 to set the minute digits.
5. Press **PROG. SET** to confirm and save settings. Press **STOP** **■** to quit setting.

Note: When system is ON, you can press **CLOCK/RDS** to display the current time (**CURR TIME**) for about 2 seconds.

Setting the Timer

1. Press and hold **TIMER** until **ON 0:00** appears with the hour flashing (**ON** - timer on time). **ALARM SET** will show on the second row of the display to indicate you are currently in timer setting mode.

ON 0:00
ALARM SET

2. Press **DIGITAL TUNING** **◀◀** or **▶▶** on the main unit or **PRESET / PREV** **◀◀** or **PRESET / NEXT** **▶▶** on the remote control to select the hour.
3. Press **TIMER** to shift to minute digits.
4. Repeat step 2 to select minute digits.
5. Press **TIMER** to shift to timer off time setting.
6. **OF 0:00** (timer off time) will show on the display with hour flashing. Repeat steps 2 - 4 for timer off time setting.
7. Press **TIMER** to select source.
8. Press **DIGITAL TUNING** **◀◀** or **▶▶** on the main unit or **PRESET / PREV** **◀◀** or **PRESET / NEXT** **▶▶** on the remote control to select between **CD MODE / TUNER / TAPE / REC TU**.
8. Press **TIMER** to set volume.
9. Rotate the **VOLUME CONTROL** knob on the main unit or press **VOL +** or **VOL -** on the remote control to set desired volume level.
10. Press **PROG. SET** to confirm and save settings. Press **STOP** **■** to quit setting.

Activating the Timer

Press and release **TIMER** to activate and deactivate the timer. **Ⓞ** will lit when the alarm is active.

EN

Settings

EN

Adjusting the Display Brightness

1. Press and hold **DIMMER/DEMO** for more than 2 seconds.
2. The display will show the current dimmer level on the first row and **DIMMER SET** on the second row to indicate you are currently in dimmer setting mode.

LEVEL 1
DIMMER SET

While the dimmer level is displayed (e.g. LEVEL 1), press and release **DIMMER/DEMO** to select the desired display brightness level (DIMMER 1 - 3).

Note: Dimmer level can only be adjusted when the unit is in ON mode.

In Standby mode, the dimmer level remains at level 3, while in magic demo mode, the dimmer level will be at level 1.

Sleep Mode

You can select the time interval in minutes before the unit turns off automatically. Press **SLEEP** on the remote to select among 120, 90, 60, 45, 30, 15, 5 minutes and OFF. **SLEEP TIME** will show on the second row of the display when in sleep setting mode. (Remote Only)

OFF
SLEEP TIME

SLEEP will light if it is activated.

Sound Features

Using Preset Equalizer Curves

Press **PRESET EQ** on the main unit or **EQ** on the remote to toggle among FLAT, ROCK, POP, JAZZ, CLASSICAL & CUSTOM. The top row of the display will show the EQ option and the second row will show **EQ MODE** to indicate you are currently selecting EQ settings.

Creating a Custom Curve

1. Press **PRESET EQ** on the main unit or **EQ** on the remote control to select **CUSTOM** mode.
2. While **CUSTOM** is displayed, press **DIGITAL TUNING** **◀** or **▶** on the main unit or **TUNE / REW** **◀** or **TUNE / F FWD** **▶** on the remote control to cycle among displayed bass (**BAS** **00**) and treble (**TRE** **00**) range levels.
3. While **BAS**, or **TRE** is displayed, adjust **VOLUME CONTROL** to set the associated gain between -10 and +10.

BAS 00
EQ SET

Bass Boost

Press **BASS BOOST** on the main unit or **B. BOOST** on the remote control to turn on/off boosting the bass frequency.

Muting Audio

Press **MUTE** on the remote to cut the sound. (Remote Only)

X-Surround

Press **X-SURROUND** to enjoy enriched sound quality. This feature gives you:

1. Better width and depth for vocal and instrumental sound.
2. More powerful presence for studio recording.
3. Enhanced surround effects with greater flexibility in positioning speakers.

CD and mp3 Playback



This unit is compatible with CD-RW/ CD-R discs for playback.

Notes on CD-R/RW Disc:

- Do not affix any type of labels to either side (recordable or labeled side) of a CD-R/RW disc as this may result in the unit malfunctioning.
- To avoid damages to the CD-R/RW disc, do not open the disc compartment door while the unit is trying to read the table of contents.
- Do not load an unrecorded CD-R/RW disc into the unit. This may take a longer time to read the disc.
- **Playback capability for CD-RW discs may vary due to variations in the quality of the CD-RW disc and the recorder used to create the disc.**

Loading Discs

1. Press **SOURCE** repeatedly to select CD mode.
2. Press **OPEN/CLOSE** on the main unit to open the CD drawer.
3. Insert up to five discs with label face up. (Press **DISC SKIP** to rotate the disc carrier.)
4. Press **OPEN/CLOSE** again to close the drawer. Loaded disc position icon lights.

Note: Be sure to remove all discs from the disc compartment before moving or transporting the unit!

Play / Pause Playback

Press **PLAY/PAUSE** to begin CD playback on the selected CD.
Press **PLAY/PAUSE** during playback to pause.
Press again to resume playback.

Play and load simultaneously by:

1. Press **OPEN/CLOSE** to open the tray while a CD is playing.
2. Load/change discs for available trays by pressing **DISC SKIP**.
3. Press **OPEN/CLOSE** to close the tray.

Stop Playback

Press **STOP** to stop playback.

Skipping Discs

Press **DISC SKIP** to skip to the next disc.
Press **DISC 1**, **DISC 2**, **DISC 3**, **DISC 4** or **DISC 5** on the remote control to access disc directly.

Skipping Tracks

Press **SKIP BACKWARD** / **SKIP FORWARD** on the main unit or **PRESET / PREV** or **PRESET / NEXT** on the remote control to skip to the next or previous tracks.

Searching Through a CD

Press and hold **SKIP BACKWARD** / **SKIP FORWARD** on the main unit or **TUNE / REW** or **TUNE / F FWD** on the remote control to search through a CD while it is playing.

Random Playback

Press / **PTY** to turn on/off the playing of tracks in random order. (Remote Only)

Sampling Tracks

Press **INTRO/C.T.** to play the first 10 seconds of each track on the current disc, all discs in the tray, or turn **INTRO** mode off. (Remote Only)

Repeat

Press **REPEAT/RDS** to repeat the current track, current disc, all discs, or turn **REPEAT** mode off.

Note: You may also press **REPEAT** to select 1 disc or all discs before activating **INTRO** & **Random** functions.

EN

CD and mp3 Playback

EN

CD Display (For Audio CDs only)

Press **CD INFO** on the main unit or **CD INFO/ FM ST** on the remote control to select among different CD display options: Track remaining time, Track elapsed time, disc remaining time or disc elapsed time.

Setting Up a CD Program

(For Audio CDs only)

Note: The unit supports single CD programming only.

You can program the CD player to play up to any 32 tracks on the normal audio CDs in the tray.

1. While the CD player is stopped, press **PROG•SET** to enter program mode.
The system displays the next available program number: "-- P:01," with "--" flashing, prompts you for the first track in the program list.
2. Press **SKIP BACKWARD** ◀◀ / **SKIP FORWARD** ▶▶ to select a track.
3. Immediately press **PROG•SET** to assign the selected track to the program number. After 3 seconds, you are prompted for the next track in the program list.
(In CD program mode, PROG icon will be lit.)

Playing a Program List

While in PROGRAM mode, press **PLAY/PAUSE** ► II .

Displaying the Program List

1. While the CD player is stopped, press **PROG•SET** to enter PROGRAM mode.
2. Press **PROG•SET** repeatedly to list each track assignment in the program list.

Deleting Program List

While in program mode, press and hold **STOP** ■ for 3 seconds. The system displays the message CLEAR.

Tips:

- You can create a program of up to 32 tracks.

Caution: Do not push to force closing of the tray during CD playback or tray opening.

CD and mp3 Playback

The MusicMatch Jukebox

This music management software, to be installed on your PC, allows you to compress music files recorded from your audio CDs into mp3 format and stores them on your PC.

- It makes the search and download of Internet music easier,
- It allows for the management of compressed music and the creation of your own playlist,
- The Jukebox is a true audio player installed on your PC,
- It gives access to thousands of net radios available on the web today.

You can download music files encoded in mp3 from several Internet sites like www.mp3.com.

Note for playing mp3 Disc

- Use .mp3 as the extension when converting audio files into mp3 for saving onto CD-R(W) or CD-ROM, e.g. Rocky08.mp3. Do not use any other extension e.g. .doc, .pdf.
- Do not use the .mp3 extension for other text or non-audio data files as this may result in serious malfunction and harmful noise interference.
- For better quality in mp3 disc playback, the CD quality should be recorded 128kbps or above.
- For UDF format (e.g. disc by Direct CD), please enable CDRom access after burning the disc when using CDR.
- Disc data size > 650MB is not recommended.
- Playback capability for CD-RW discs may vary due to variations in the quality of the CD-RW disc and the recorder used to create the disc.
- For mixed mode discs, only one mode will be selected for playback depending on the recording format.
- To ensure good performance, wait until the disc changer completely reads the disc before proceeding.
- MP3 files in CD ROM EXTRA format disc cannot be recognized.

File Navigation

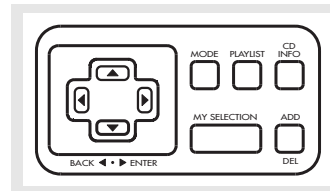

BACK / LEFT ◀ - Goes up one folder from current folder.

ENTER / RIGHT ▶ - Enters current folder and shows the first file/folder from current folder.

▲ **UP** - Selects previous file/folder.

▼ **DOWN** - Selects next file/folder.

MY SELECTION - For mp3 CDs with SmartTrax, access My Selection folder.

MODE - Selects between SmartTrax mode and normal mp3 mode.

PLAYLIST - For mp3 CDs with SmartTrax, accesses additional CD playlists.

Note: The unit can access a maximum of 8 playlists.

ADD/DEL - For mp3 CDs with SmartTrax, adds and remove songs from My Selection

CD DISP/FMST - Toggles ID3 TAG when playing mp3 music. Press to view among the following: File Name, Album, Artist, Genre, Year and Bit Rate.

Note: The display can show up to 10 characters per line at one time. If the item has more than 10 characters, it will scroll from left to right to show the entire item.

The number of characters available on the display varies among different items.

ITEM	MAXIMUM NUMBER OF CHARACTERS
Artist	16
Album	16
Song	16
Genre	12

EN

CD and mp3 Playback

EN

mp3 Format

When a mp3 audio disc is read, the mp3 icon will light on the display. The titles in the home directory will be displayed.

FOLDER will light on the display if the current title is a folder.

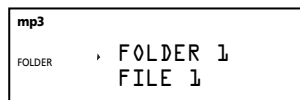

FILE will light if the current title is a file.

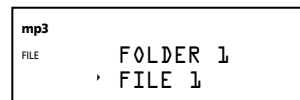

Note: The arrow cursor on the left side of the title indicates your current position.

SmartTrax

SmartTrax is a music management system that allows for the organization of mp3 or WMA files into 6 standardized categories. The categories include My Selection, Playlist, Artist, Album, Genre and Song. This systematic arrangement shortens the initiation time for mp3 discs. Navigation also becomes easier as files are placed into folders.

If the mp3 disc is formatted with the Smart Trax feature, the Smart Trax icon lights on the display. The items in the root directory consist of 4 categories: ARTIST, GENRE, ALBUM and SONG.



Note: SmartTrax CDs can only be created using the MusicMatch Jukebox software. Go to www.musicmatch.com for MusicMatch Jukebox details.

Playing a mp3 disc

1. Insert a mp3 CD into the CD tray, you will see the name of the first two folder (or root directory) displayed on the screen.
2. Press the **▲ UP** / **▼ DOWN** button to scroll up and down and select the title you want to access.
3. If the selected title is a folder, press **ENTER / RIGHT ►** to enter into the folder selected. Press **BACK / LEFT ◀** to return to the previous folder.
4. Once the title you want to play is selected, press **PLAY/PAUSE ►||** button to start playback.

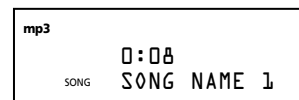

If a folder is selected for playback, all the songs in the folder will be played starting from the first title.

If a song is selected for playback, the selected song becomes the starting point. Playback continues until all songs after the selected one is played.

5. During playback, press **SKIP BACKWARD ◀◀** / **SKIP FORWARD ▶▶** on the main unit or **PRESET PREV ◀◀** / **PRESET NEXT ▶▶** on the remote control to skip songs within the same folder.
6. Press **Stop ■** to end playback and resume navigation.

Track Information

To view detailed information about the track being played, press **CD INFO** repeatedly during playback to view Title, Artist, Genre, Year and Bit rate.

The information will scroll along the display and the corresponding indicator will light on the left of the display.

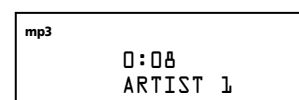

CD and mp3 Playback

EN

Additional SmartTrax Features

Navigating through SmartTrax CDs is similar to that of a normal mp3 CD. Additional features are available for Smart Trax CDs that make it more preferable.

For a SmartTrax CD, when you enter into one of the folders in the root directory, the corresponding icon lights on the left side of the title to show your location. For example, if you enter into the Artist category, the ARTIST icon will light.

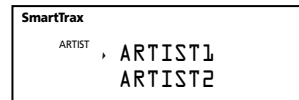

If you press **ENTER/RIGHT** ► to enter further into a folder where all the songs are listed, Song icon will light.

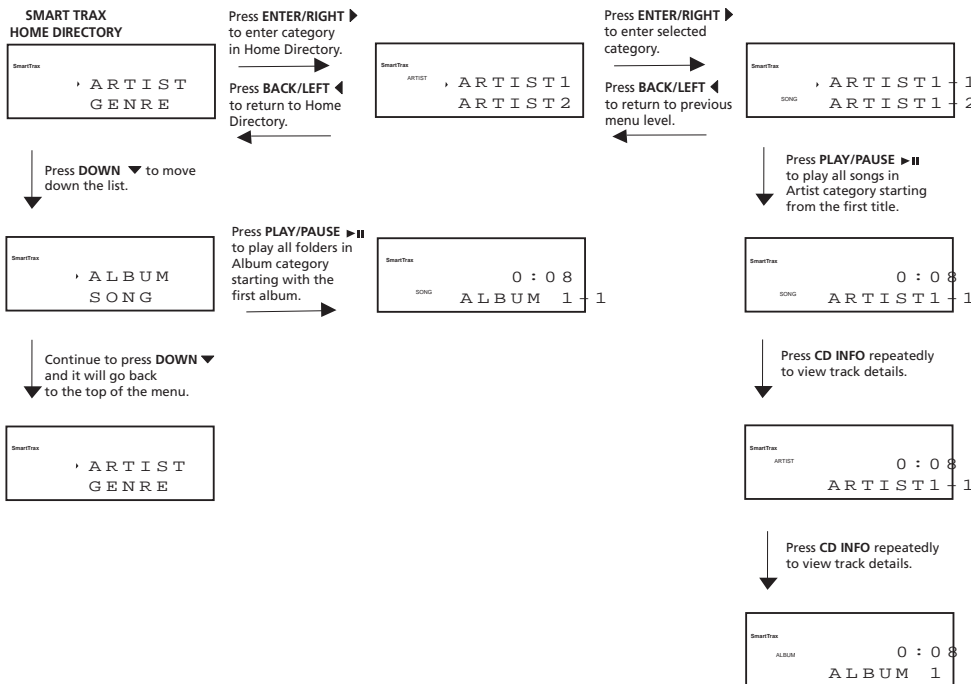
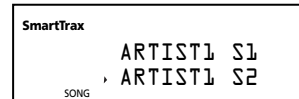

CD and mp3 Playback

EN Mode

With a SmartTrax CD, press **MODE** to select between SmartTrax mode and normal mp3 mode.

SmartTrax
MY SELECT
IS FULL

Playlist (For Smart Trax CDs only)

Press **PLAYLIST** to access additional playlists that are available on the CD.

My Selection (For Smart Trax CDs only)

Selected titles can be bookmarked and placed into My Selection folder.

Selecting Titles to be Placed into My Selection

1. Use the navigation buttons to select the title you want to place into My Selection.

SmartTrax
ARTIST 3
ARTIST 4

2. Press **ADD / DEL** to select the title. **ADD TO MY SELECT** will show on the display for a few seconds.

SmartTrax
ADD TO
MY SELECT

- icon will show on the left side of the title to indicate the item is selected. If this icon appears in front of a folder, it indicates certain items in the folder is selected.
- icon indicates that all items in the selected folder are selected.

SmartTrax
ARTIST 3
ARTIST 4

If My Selection playlist is full, the display will show **MY SELECT IS FULL** and no additional titles can be added until space becomes available. Refer to "Deleting Titles from My Selection" to delete titles.

View My Selection

Press the **MY SELECTION** button on the main unit or **MY SELECT** on the remote control to view items in My Selection folder.

All titles in My Selection folder are listed as songs.

If there are no songs in My Selection, the below screen is displayed.

SmartTrax
NO SONG
AVAILABLE

Deleting Titles from My Selection

1. View titles in My Selection folder.
2. Use the navigation buttons to select the title you want to delete from My Selection.
3. Press **ADD/DEL** to delete the title. The display will show as below.

SmartTrax
DELETE ONE
YES--ENTER

Press **ENTER/RIGHT** ► while the message is still on display to delete the title.

Delete All Titles from My Selection

1. View titles in My Selection folder.
2. Press and hold **ADD/DEL**. The display will show as below.

SmartTrax
DELETE ALL
YES--ENTER

Press **ENTER/RIGHT** ► while the message is still on display to confirm action.

Tuner

Selecting Tuner

1. Press **SOURCE** to select **TUNER**.
2. Press **BAND** to select between FM/MW/LW radio band.

Tip: Your audio system has 32 preset stations.

Tuning to a Station

Press **DIGITAL TUNING** **◀** or **▶** on the main unit or **TUNE REW** **◀** / **TUNE F FWD** **▶** on the remote control to select frequencies.

Using Presets

The tuner can be either TUNE or PRESET mode. When in PRESET mode, the PROG light is on.

- Press **TUNE/PRESET** on the main unit to toggle TUNE and PRESET mode.
- Press **DIGITAL TUNING** **◀** or **▶** on the main system or **PRESET PREV** **◀** or **PRESET NEXT** **▶** on the remote control to access the previous or next preset station. The display first shows the preset program number and after a few seconds, the frequency will be displayed. (FM/PR:01 is FM preset 1)

Auto Preset Programming (for FM only)

Press and hold **BAND/AUTO PROG./DECK1•2** button for 2 second to scan stations in the selected band. The stations will then be stored as preset channels. A maximum of 32 stations can be stored. Beware of your preset channels being erased accidentally because the scanning and storing process is automatic upon pressing the button.

You can stop the automatic scan by pressing any button, but the erased stations cannot be recovered.

Manually Setting Presets

1. Press **TUNE•PRESET** to enter TUNE mode.
2. Press **DIGITAL TUNING** **◀** or **▶** to access the desired frequency.
3. Press the **PROG•SET** button once.
4. The most recently accessed program location will be displayed.
5. If a different program location is preferred, press **DIGITAL TUNING** **◀** or **▶** to move to the desired preset number (1-32).

6. Press **PROG•SET** to store the selected frequency at that preset.

EN

Suppressing Stereo Signal

Press **CD INFO/ FM ST** on the remote control to toggle between FM mono and stereo for stereo FM stations.

Tuning to an RDS Station

Tip: RDS stations broadcast on FM only. When the tuner detects an RDS signal, the RDS icons turns on.

1. Press **TUNE•PRESET** to access preset station or press **DIGITAL TUNING** **◀** or **▶** to desired frequency.
2. If RDS station found, RDS lights on display with station name shown.

Displaying RDS Station Information

Press **CLOCK/RDS** on the main unit or **REPEAT/RDS** on the remote control to display the frequency, station name (PS), station type (PTY), clock time (CT), or radio text (RT). In CT mode, press **INTRO/CT** key to replace the displayed time by RDS station time. If clock time is not yet set, this information will be shown as clock time automatically.

Searching by Program Type (PTY) (Remote Only)

1. Press **◊** / **PTY** to enter PTY selection
2. Toggle **◊** / **PTY** to select a **PTY** mode.
3. Within 5 seconds, press **DIGITAL TUNING** **◀** or **▶** to search for a station broadcasting the selected type of program.

You can search for stations using one of the following program types:

RDS NEWS (news), AFFAIR (news and documentaries), INFO (weather, medical), SPORT (sports), EDUCAT (education), DRAMA (series and plays), CULTUR (religion), SCIENC (science and technology), VARIED (miscellaneous), POP M (pop music), ROCK M (rock music), MOR M (middle-of-the road music), LIGHTM (light music), CLASSI (classical music), OTHERM (unclassified music), ALARM (alarm).

Tape Player

Playing a Tape

Tip: You can play a tape from either deck.

1. Press **SOURCE** repeatedly to select **TAPE**.
2. Press the cassette door to open it.
3. Insert a tape into the door and push the door closed.
4. Press **BAND/AUTO PROG/DECK 1•2** to select deck 1 or 2.
5. Press **SKIP BACKWARD** ◀◀ / **SKIP FORWARD** ▶▶ to position the tape to the desired starting position.
6. Press **PLAY** ▶ **II** to begin playback.

Continuous Play

1. Press **PRESET/NEXT** ▶▶1 on the remote control to enable continuous play. "C" will appear before the counter.
2. Insert cassette tapes into deck 1 and 2.
3. Press **BAND/DECK 1/2** to select the deck to play first.
4. Press **PLAY** ▶ **II** to begin continuous playback.
5. Press **PRESET/PREV** I◀◀ to disable continuous play.

Tape Counter

You can keep track of tape position with the tape counter. Press **PROG•SET** to reset.

Recording

From Tuner

1. Insert a tape into deck 1.
2. Press **SOURCE** repeatedly to select **TUNER** and to access the desired radio band.
3. Tune to the station to be recorded.
4. Press **RECORD** to begin recording.
5. Press **STOP** ■ to end recording.

From CD

1. Insert a tape into deck 1.
2. Press **SOURCE** repeatedly to select **CD**.
3. Insert the disc(s) to be recorded.
4. Select the track, CD, or program to be recorded.
5. Press **RECORD** to begin recording.
6. **CD** begins to play.
7. Press **STOP** ■ to end recording.

Tape to Tape

Synchronize Recording

1. Insert the destination tape in deck 1.
2. Insert the source tape into deck 2.
3. Press **RECORD**. The playback and recording start simultaneously.

Normal Recording

1. Insert the destination tape in deck 1.
2. Insert the source tape into deck 2 and press **PLAY** ▶ **II**.
3. Press **RECORD** when ready to record.

From an Auxiliary Input

1. Insert the cassette in deck 1.
2. Press **SOURCE** repeatedly to select **AUX**.
3. Check that the auxiliary device has been connected correctly to the **GAME AUX** connector on the front of the audio system.
4. Start playback on the auxiliary device.
5. Press **RECORD** on deck 1 to begin recording.
6. Press **STOP** ■ to end recording.

Troubleshooting Tips

EN

Problem	Solution	Problem	Solution
<i>System will not turn on</i>	<ul style="list-style-type: none"> • Check power cord for a secure connection. • Unplug the unit for a moment, and then plug into power source again. • Check the outlet by plugging in another device. 	<i>CD button will not respond, or does not change discs when you press DISC SKIP</i>	<ul style="list-style-type: none"> • Switch to another function (TAPE, Tuner) and then back to CD.
<i>No sound</i>	<ul style="list-style-type: none"> • Increase the volume setting. • Check connection to speakers. • Check that you have selected the appropriate function: CD, TAPE, Tuner. • Make sure mute is off. • Make sure headphones are not plugged in. 	<i>MP3 disc does not play</i>	<ul style="list-style-type: none"> • Only finalized MP3 CDR/CDRW disc is accepted. MP3 format burnt by some software (such as DIRECT CD) may not run properly.
<i>Poor radio reception</i>	<ul style="list-style-type: none"> • Check antenna connection. • Move antenna. • Turn off nearby electrical appliances, such as hair dryer, vacuum cleaner, microwave, fluorescent lights. 	<i>Distorted or noisy tape recordings</i>	<ul style="list-style-type: none"> • Inspect the tape heads, clean it if necessary.
<i>CD does not play</i>	<ul style="list-style-type: none"> • Check that CD is in the tray. • Check that CD label is facing up. • Check that PAUSE mode is not on. • Check that CD function is selected. • Use CD lens cleaner. • Clean the disc. • Try another CD. 	<i>Remote control does not work</i>	<ul style="list-style-type: none"> • Check that the batteries are properly installed. • Replace weak batteries. • Check the system is plugged into power source. • Point the remote directly at the system's front panel. • Move closer to the system. • Remove any obstacles between the remote and the system.
<i>CD sound skips</i>	<ul style="list-style-type: none"> • Clean the disc. • Check disc for warping, scratches, or other damage. • Check if something is causing the system to vibrate. If so, move the system. • Make sure the speakers are at least 3 feet away or on a different surface from the main unit. 		

Maintenance

EN

Disconnect the audio system from the power source before performing any maintenance.

Cleaning

Clean the exterior of the system using a soft dust cloth.

CD Player

CAUTION! This system operates with a laser. It must be opened by only a qualified technician.

Tape Player

To prevent deterioration of sound quality, periodically open the door of each deck and clean the magnetic heads, pinch roller, and capstan with a cotton bud dipped in alcohol. Also, demagnetize the head by playing a demagnetizing cassette (available through an audio equipment store).

To protect recordings one or both sides of a tape, remove the corresponding tab. If you later want to record on the tape, affix a piece of adhesive tape over the hole.

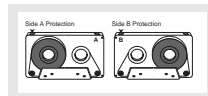

Quit Slacking - A little bit of slack in your tapes can cause scratches on the tape, or worse yet, the tape could break. If you notice some slack in the tape, use a pencil to tighten it up before you insert it.

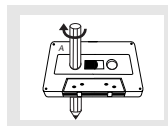

Handling CDs

- Do not touch the signal surfaces. Hold CDs by the edges, or by one edge and the hole. Do not affix labels or adhesive tapes to the label surfaces. Do not scratch or damage the label. CDs rotate at high speeds inside the player. Do not use damaged (cracked or warped) CDs

Cleaning CDs

- Dirty CDs can cause poor sound quality. Always keep CDs clean by wiping them gently with a soft cloth from the inner edge toward the outer perimeter.
- If a CD becomes dirty, wet a soft cloth in water, wring it out well, wipe the dirt away gently, and then remove any water drops with a dry cloth.
- Do not use record cleaning sprays or antistatic agents on CDs. Also, never clean CDs with benzene, thinner, or other volatile solvents which may cause damage to disc surface

CD Lens Care

When your CD lens gets dirty it can also cause the system to output poor sound quality. To clean the lens you will need to purchase a CD lens cleaner which can maintain the output sound quality of your system. For instructions on cleaning the CD lens, refer to the ones accompanying the lens cleaner.

Important Information

EN

Safety Precautions

- Never open the cabinet under any circumstances. Any repairs or internal adjustments should be made only by a trained technician.
- Never operate this product with the cabinet removed.
- Do not use your System immediately after transporting it from a cold place to a warm place, as condensation may cause the system to malfunction.
- Keep your unit away from humid areas and abnormally hot places.
- Do not touch the player with wet hands. If any liquid enters the player cabinet, take the player to a trained technician for inspection.
- This compact disc player uses a laser to read the music on the disc. The laser mechanism corresponds to the cartridge and stylus of a record player. Although this product incorporates a laser pick-up lens, it is completely safe when operated according to directions.
- Discs rotate at high speed inside the player. Do not use damaged, warped, or cracked discs.
- Do not touch the pick-up lens which is located inside the disc compartment. To keep dust from collecting on the pick-up lens, do not leave the compartment door open for an extended period of time. If the lens becomes dirty, clean it with a soft brush, or use an air blower brush designed for camera lenses.
- The apparatus shall not be exposed to dripping and splashing.

Important Battery Information

- Remove the batteries to avoid leakage if you do not use your remote control for more than one month.
- Discard leaky batteries immediately as leaking batteries may cause skin burns or other personal injuries. Dispose of batteries in the proper manner, according to provincial and local regulations.
- Any battery may leak electrolyte under the following circumstances:
 - if mixed with a different battery type,
 - if inserted incorrectly,
 - if all batteries are not replaced at the same time,
 - if disposed of in fire, or
 - if an attempt is made to charge a battery not intended to be recharged.

Headset Safety

- Do not play your headset at high volume. Hearing experts warn against extended high-volume play.
 - If you experience ringing in your ears, reduce volume or discontinue use.
 - You should use with extreme caution or temporarily discontinue use in potentially hazardous situations.
- Even if your headset is an open-air designed to let you to hear outside sounds, do not turn up the volume so high that you are unable to hear what is around you.

Don't Infringe

This product should only be used for the purposes for which it is sold, that is, entertainment, violating no copyright law. Any attempts to use this product for unintended purposes are unlawful and therefore not condoned by Thomson.

Technical Specification

Power supply: 230V-50Hz
 Dimensions (H x W x D mm):
 Unit size - 311 x 306 x 390
 Speaker - 311 x 240 x 197
 Tape deck: Response curve: 125Hz-8kHz (-5dB)
 CD player: Response curve (+/- 2dB): 60Hz to 5kHz
 Rating Plate: Look for it at the back of the set.

The descriptions and characteristics given in this document are given as a general indication and not as a guarantee. In order to provide the highest quality product possible, we reserve the right to make any improvement or modification without prior notice. The English version serves as the final reference on all products and operational details should any discrepancies arise in other languages.