



## Installation Manual

AH-45201

AH-45301

AH-45401

(Only for EIP-4500L)

AH-51401

(Only for EIP-5000L)

AH-45501

AH-45601

AH-45701

**WARNING:** This installation manual is for use by service personnel. Please be aware that the manufacturer cannot be responsible for breakage or damage incurred due to improper installation of this lens or use of the projector.

When replacing the lens, please have the lens replaced by the store of purchase or an EIKI Engineering certified service workshop. The inside of the projector contains high-voltage parts that can be extremely dangerous. Never attempt to replace the lens by yourself.

Always make sure to turn off the main power and unplug the power cord before replacing the lens.  
Be careful not to allow any screws to drop inside the projector while working. This can cause a fire, electrical shock or malfunction.

Do not attempt to replace the lens while the projector is suspended from the ceiling. The lens may fall out of the projector resulting in injury.

Before replacing the lens, return the lens shift to the position shown below. (The lens shift is adjusted to the position shown below when shipped from the factory.)

- V (vertical) shift: Uppermost position
- H (horizontal) shift: Middle position

When replacing the lens, use a commercially available screwdriver that satisfies all of the conditions indicated below.

- Type 2 Philips head screwdriver
- Length of protruding section: min. 180 mm (10")
- Magnetized

# 1 2

Loosen the lamp replacement screw (①) that fastens the lamp unit cover, and remove the lamp unit cover by sliding in the direction shown by the arrow (②).

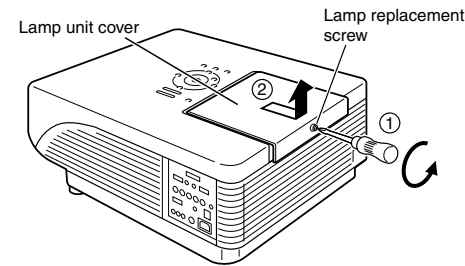

Remove the mounting screws of the top cover.

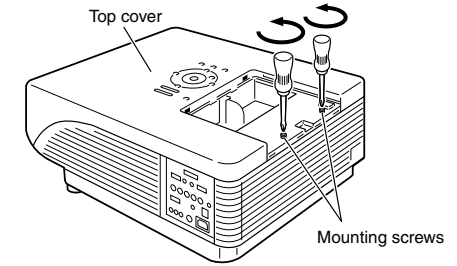

# 3 4 5 6

Unplug the cable connector (①) and remove the top cover (②).

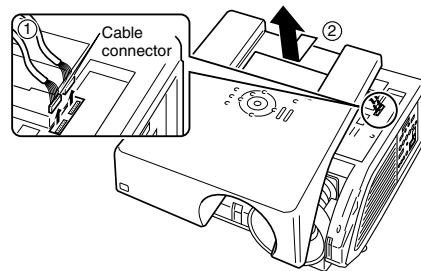

Release the tabs while pulling up on the lens cover, and then pull it out towards you.

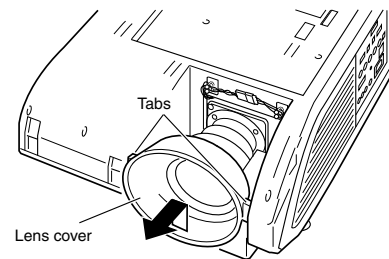

(When the lens being removed is the AH-45401 (EIP-4500 standard lens) or AH-51401 (EIP-5000 standard lens))  
Remove the lens ring by turning in the direction shown by the arrow.

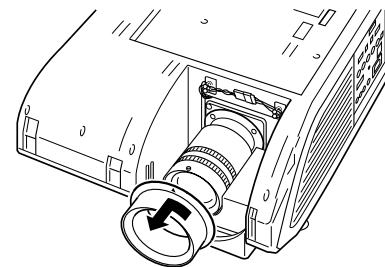

Unplug the cable connector.

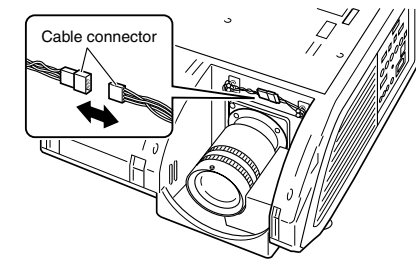



# 7

Remove the lens mounting screws.

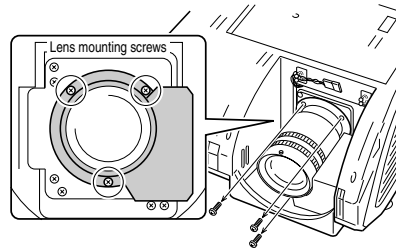

# 8

Pull out the lens towards you and then take out the lens (2) by rotating it 90 degrees (1) in the direction shown by the arrow.

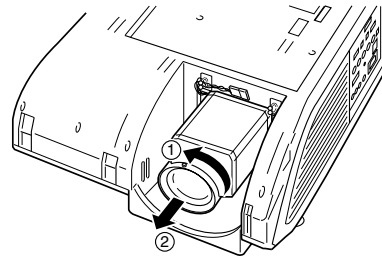

# 9

Remove the lens cap (on the back) from the replacement lens.

- This explanation uses the example of the AH-45201.

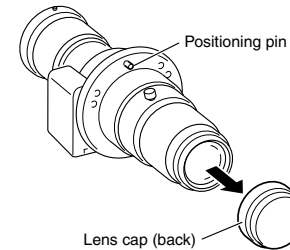

# 10

Insert the replacement lens into the lens mount with the motor section facing up.

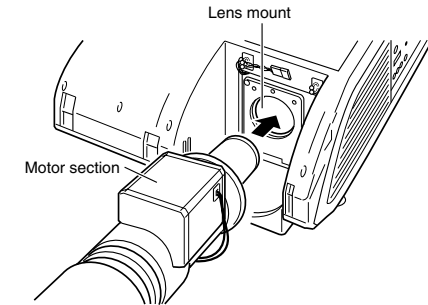

# 11

Rotate the replacement lens 90 degrees in the direction shown by the arrow (1), align the positioning pin with the guide hole, tighten the lens mounting screws (2) and then connect the cable connector (3).

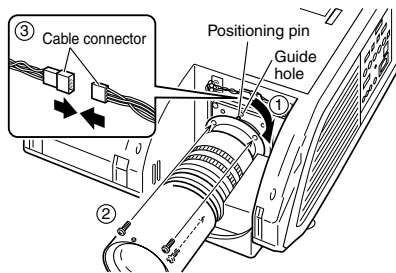

# 12

(When the lens being attached is the AH-45401 (EIP-4500 standard lens) or AH-51401 (EIP-5000 standard lens))

Attach the lens ring.

- Align the ▲ mark on the lens ring with the positioning pin on the lens (silver pin), insert the lens ring all the way to the back and then rotate in the direction of the arrow.

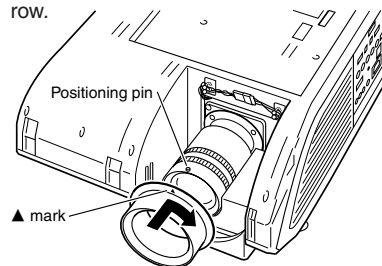

# 13

Attach the lens cover.

- Insert the lens cover while spreading apart the ring section (made of rubber), and then attach the tabs to the ribs.

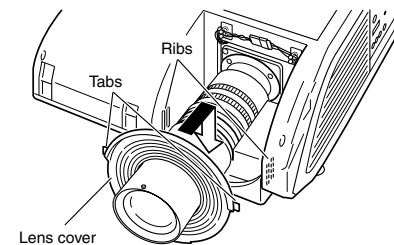

# 14

Connect the cable connector by following steps 1 through 3, and then attach the top cover and lamp unit cover.

- The power of the projector will not come on unless the lamp unit cover is securely attached.

Printed in China  
9NK5010060800  
07P03-CH-NM