

# Haier

**25F3A-T**  
**25T3A-T**  
**25F3A**  
**25T3A**

## **COLOUR TV RECEIVER**

---

## **OWNER'S MANUAL**

### **MAIN FUNCTIONS**

- Slide Curtain Power On/Off Display
- 218 Channels Preset
- Multiple Picture & Sound Modes
- On/Off Timer
- Child Lock
- Soft Change Channel Function
- Count Time
- Channels Appointment
- DVD Video Component Input Terminals

Please read this manual carefully before operating the unit, and keep it for future reference.

# CONTENTS

---

## Before Operation

Warning and Cautions	2
Installation	3
Antenna connection	3
Preparation for the remote control	3
Position of keys and plug-ins	4
Front panel	4
Back panel	4
Using the remote control	5

---

## Basic Operation

Power on and power off	6
Viewing TV programs	7
Viewing TV programs	7
Program scan and screen display	8
Tuning	9
Automatic search	9
Manual search	10
MFT	11
Skip	12
Adjusting the picture and the sound	13
Multiple picture modes	13
Multiple sound modes	14
S.C.C, count and mute	15
Setting the Timer	16
Timr off	17
Sleep timer and timer on	18
Channels appoinment	18
Setting the other function	19
Language and screen protection	19
Curtain function and calendar display	20
Channel exchange	21
Setting the lock	22
Changing your password	22
Setting the lock	23
Game	24
Game control buttons and method of playing the game	24

---

## Technical operation

Connecting Additional Equipments	25
Connecting additional equipment	25

---

## Others

Troubleshooting	26
Specifications	27

# Warning and Cautions

1. When you clean the TV set, please pull out the power plug from AC outlet. Don't clean the cabinet and the screen with benzene, petrol and other chemicals.



4. To prevent the TV set from firing and electric shock, don't expose the TV set to rain or moisture.

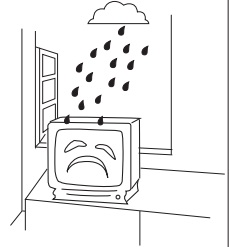

2. In order to prolong the using life of the TV set, please place it on a ventilated place.

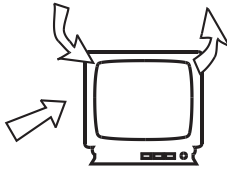

5. Don't open the back cover, otherwise it is possible to damage the components in the TV set and harm you.

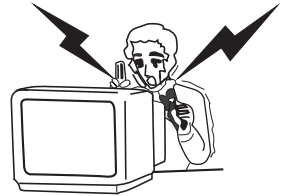

3. Don't place the TV set in the sunshine or near heat source.

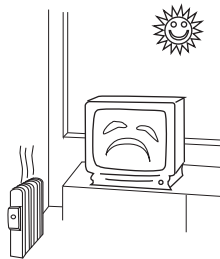

6. When the TV set isn't going to be used for long time or it is in thunder and lightening, please pull out the plug from AC outlet and the antenna plug from the cover of the TV set.

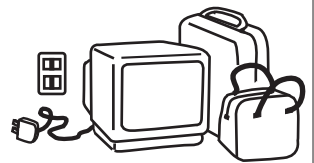

## Explanation on the display tube

In general, it is not needed to clean the tube surface. However, necessary, it's surface can be cleaned with a dry cotton cloth after cutting off the power. Don't use any cleanser. If using hard cloth, the tube surface will be damaged.

# Installation

## Antenna connection

Generally speaking, to enjoy a clearer picture, we recommend that you use a CATV system or an outdoor antenna. In different places, the suitable antenna type and position are different.

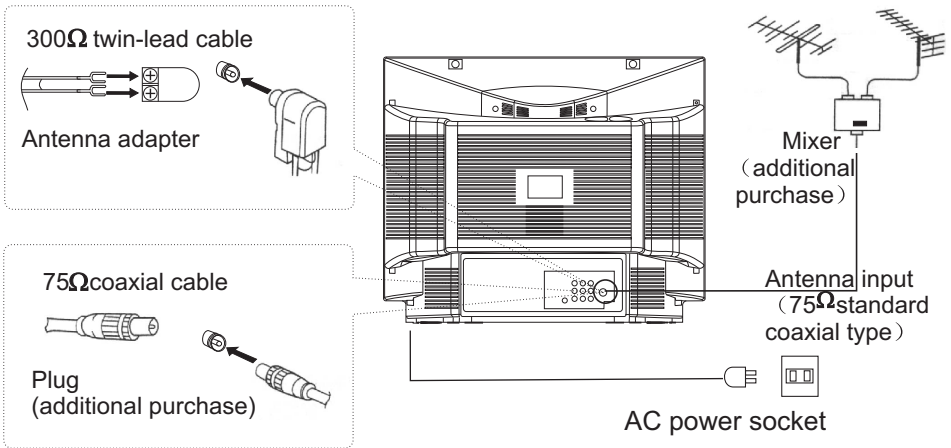

### Note:

- \* It is recommended that you'd better use 75 $\Omega$  coaxial cable to remove the disturbance caused by airwave.
- \* Don't bind antenna cable and electric wire together.

## Preparation for the remote control

### Battery installation

Remove the batteries cover.

Insert two size AA batteries matching the +/- polarities of the battery to the +/- marks inside the battery compartment.

### Tips for remote operation

The battery life should be about one year under normal use.

When the remote control will not be used for a long period of time or when the batteries are worn out, remove the batteries to prevent leakage.

Do not throw the batteries into a fire. Dispose of used batteries in the specified manner.

Do not drop, dampen or disassemble the remote control.

# Position of Keys and Plug-ins

## Front panel

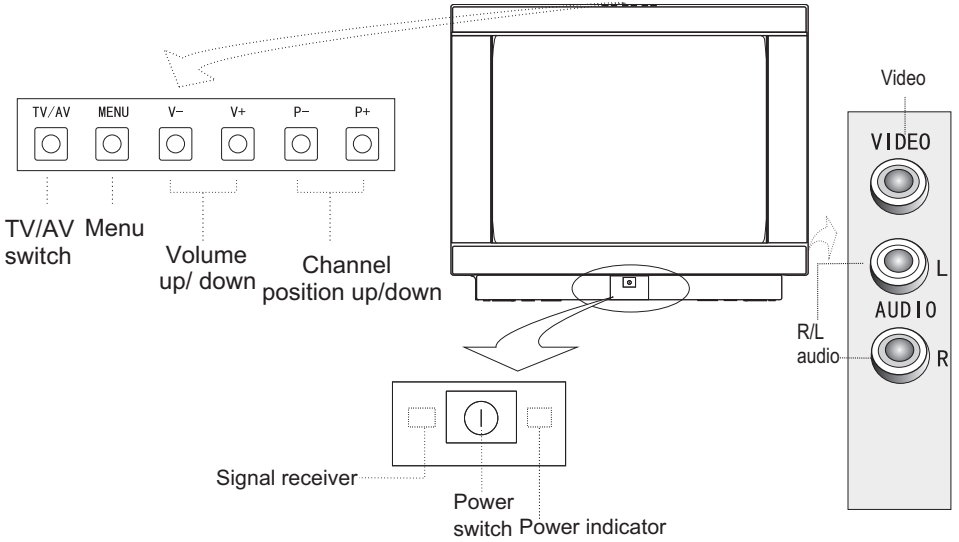

Please do not use the side and back AV terminals simultaneously

## Back panel

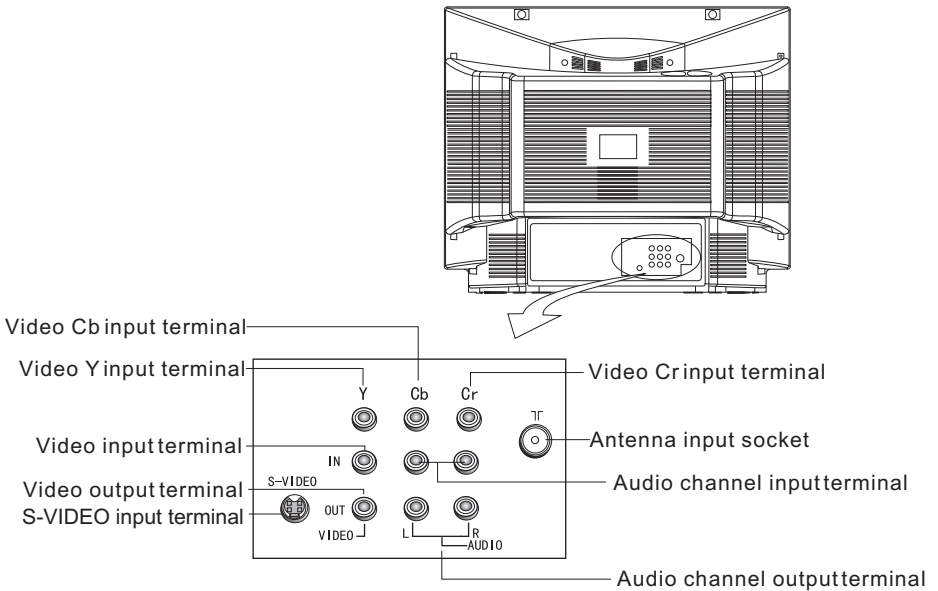

# Using the Remote Control

## Buttons and Descriptions

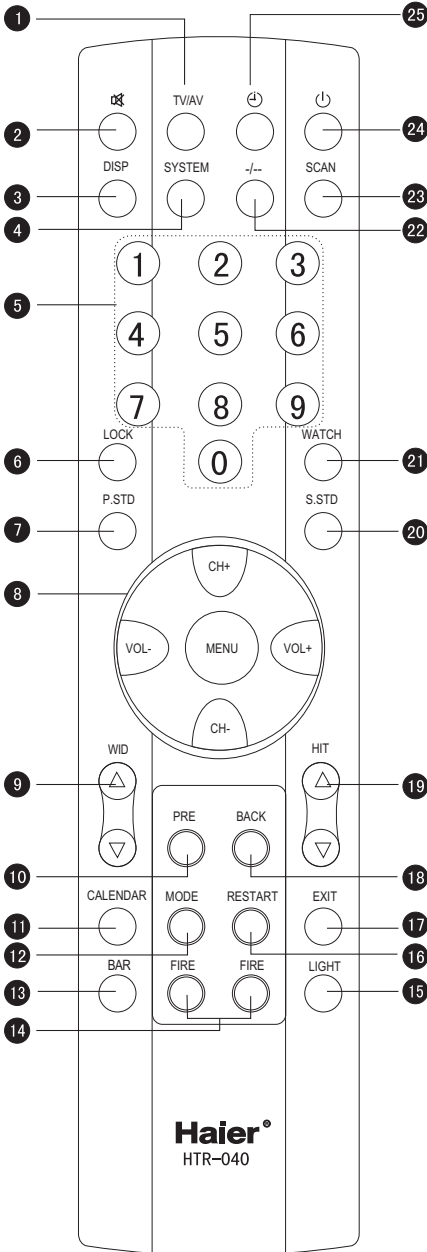

- 1 TV and AV Exchange Button  
To exchange between TV and other available video inputs
- 2 Mute Button  
Press to conceal the sound of programs.
- 3 Screen Display Button
- 4 System Adjust Button
- 5 Direct-digit Choosing Button  
Directly select channel numbers
- 6 Lock Setting button  
Used for setting lock for channel-searching, channel, AV and clock, etc.
- 7 Picture Mode Select Button  
There are DYNAMIC, STANDARD, MILD, MEMORY, PICTURE MUTE and COLOR MUTE six modes of picture.
- 8 Menu Select/Adjust Button  
Use this button to adjust the menu, the volume and the channels, as well as to control the game.
- 9 Chromatic Belt Length Adjust Button (not available)
- 10 Program Play-forward Button
- 11 Calendar
- 12 Game Background Select Button
- 13 BAR Button(not available)
- 14 Fire Button(can call the calendar)
- 15 Background Lamp Control Button (not available)
- 16 Restart Game Button
- 17 Game Exit Button
- 18 Program Play-backward Button
- 19 Chromatic Belt Width Adjust Button (not available)
- 20 Sound Mode Select Button  
There are high, normal and low three kinds of sound modes.
- 21 Stopwatch Button  
The stopwatch can work 1 hour without interruption and when you use this function, do not operate other function button as well.
- 22 Digit Select Button  
Change the channel position number between one digit, two-digits and three-digits.
- 23 Program Scan Button
- 24 DC Standby Button
- 25 Sleep Timer Button

# Power On and Power Off

- Below are methods on how to power on/off the TV set with the switch on the TV and on the remote control.

## Power on/off

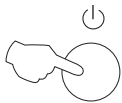
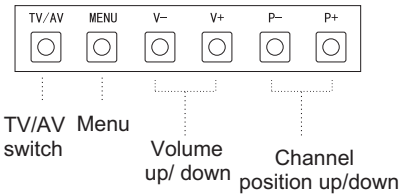
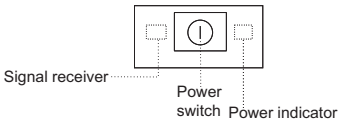

DC Standby Button

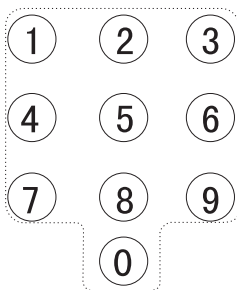

Direct-digit Choosing Button

## Connect/disconnect to the power

1. Connect the power supply wire, then press power switch button, the red power indicator will light, in several seconds the picture will appear on the screen.

2. If the TV is in the state of standby, press the  button on the remote control.

### NOTE

1. You can also press the 0-9 button to call off the standby status instead of pressing the DC Standby button. Press the digit button of the preset channel (limited to one digit), you can complete the selection of channel while you turn on the TV set( To operate the preset of TV channel, please see TUNING on page 9-12).

2. When you do not use the remote control, you can directly press the the button on the television to call off the standby status.

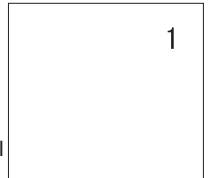

3. Press the  button on the remote control to get into the standby state.

4. Press the  button on the TV set to completely turn off the TV.

## Power supply auto-off function

When the B.B(black background) is set ON, and there is no signal , game screen protection works, and ,in15 minutes later, it will change into standby status.

# Viewing TV Programs

- The channels amount to 218(0-218).

## Viewing TV programs

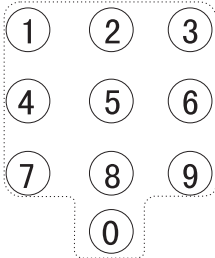

Direct-digit Choosing button

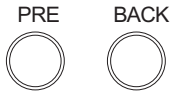

SYSTEM

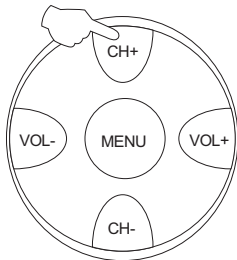

### How to select the TV program

1. Use the direct-digit choosing button
  - Press the button from 0-9 to select a one digit channel.
  - If you want to select a two-digits channel, press the Digit Select button and change it into two-digits mode, then press the number of the channel.
  - If you want to select a three-digits channel, press the Digit Select button and change it into three-digits mode, then press the number of the channel.
  - If the channel position number you select is larger than 218, the TV will use the first two number as the channel position.
2. Use CH+/- button
  - Press CH+ to increase the channel position number.
  - Press CH- to decrease the channel position number.
3. Use PRE button and BACK button
  - Press PRE button, you can go back to the channels you viewed (as many as four).
  - Then, press Back button, you can return to the channels you were watching just now (as many as four).
  - For example, if you have viewed channel 1,2,3,4,5,6 after the TV is powered on, and the channel you are watching now is number 7, then press PRE button, you can view channel 6,5,4,3, and you may press the Back button to return to channel 7.

### Choose the proper volume you like

Press VOL+/- button to adjust the volume.

- If the VOL STORE is set ON, the volume of the pre-fifty channel will be stored independently.
- Press VOL+ to increase the volume, press VOL- to decrease the volume.

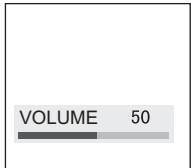

### If the color or sound of one channel is abnormal

It might be because the color or sound system has been set improperly. You may follow the instruction below to adjust it. Press SYSTEM button, and you can see the form.

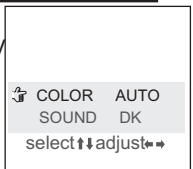

- If the color of the picture is abnormal Press CH+/- button, and move the indicator ( ) to COLOR, and press VOL+ button to select the proper color(AUTO,PAL, SECAM,NTSC4.43 and NTSC3.58 will appear alternately).

- If the sound is abnormal Press CH+/- button, and move the indicator ( ) to SOUND, and press VOL+/- button to select the proper sound (DK and BG will appear alternately).





# Viewing TV Programs (continued)

- Program scanning function is to let the television automatically scan all preconcerted channel program (about two seconds per channel).

## Program scan and screen display

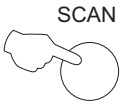

### Program scanning function

1. If you want to scan the programs and select your favorite channel, just press the SCAN button, then the television will start scanning from the present channel with a rate of two seconds per channel and until all the preconcerted programs have been displayed once, the TV set will return to the starting channel.

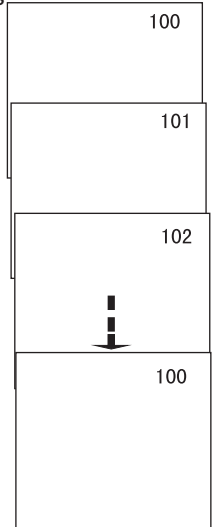

2. If you want to terminate this function during the scanning, press the SCAN button again, and the program will stay at the present channel.



### Screen display

Usually, when you press the DISP button, the channel number will appear on the top right corner of the screen and press it again, the screen's top left corner will display the present time (the adjustment of time please see Setting the Timer). If press it for a third time, the channel number and time will both disappear.

# Tuning

- There are three ways of searching: automatic search, manual search and MFT (manual fine tune).
- You may operate it either on the TV or on the remote control. Here is mainly about the remote control.

## Automatic search

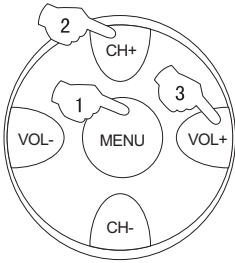

### Automatic search

1. Press MENU button, until TUNING appears on the screen.

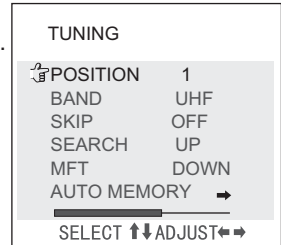

2. Press CH+/- button to move the indicator (↔) to AUTO MEMORY.

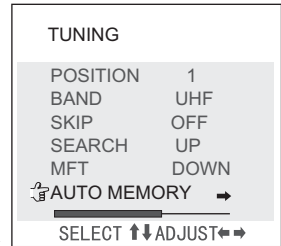

3. Press VOL+, then AUTO MEMORY mode will work.

The TV set will search automatically all available programs, after that, all available programs will be stored in turn and the TV set will return to the first channel.

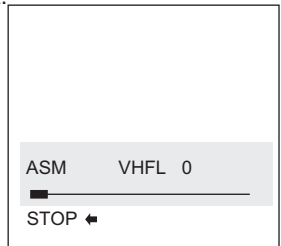

- If you want to stop the search, just press VOL- button.
- The order of the automatic search is due to the frequency of the program, generally speaking, it is used only at the first time you search the program, and once the order of the program has been confirmed, you don't have to use this function, otherwise the order of the program will be changed.

### After searching

- Press CH+/- button to check the channels.
- If the color or sound is abnormal in a certain channel, it may be the color or sound system has not been set properly, so you should adjust it to the proper system (Reference to page 7).

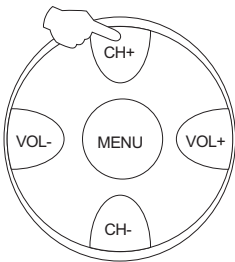

# Tuning(continued)

## Manual search

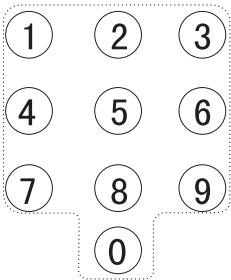
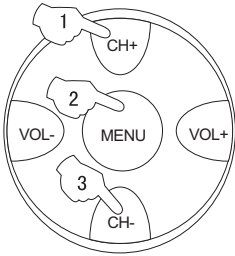

Direct-digit Choosing Button

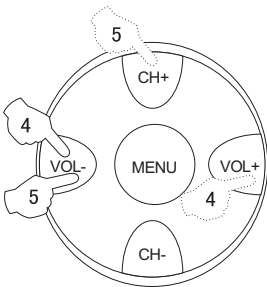

### Manual search

1. Press CH+/- button or the Direct-digit Choosing button to select a channel directly(take channel 1 for example).

2. Press MENU button, until TUNING appears on the screen.

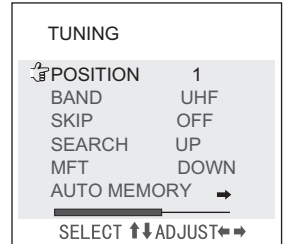

3. Press CH- button and move the indicator( ) to SEARCH.

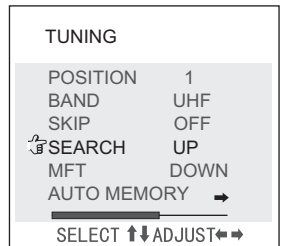

4. Press VOL+/- button to start searching.  
VOL- button is used to search the lower frequency channel.  
VOL+ button is used to search the higher frequency channel.  
Repeat the steps until you find the channel you need.

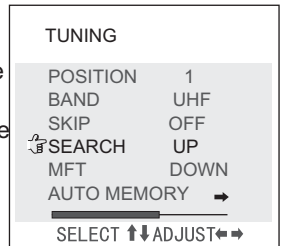

5. When you plan to store another new channel at a new place, use CH+/- button and move the indicator( ) to POSITON, then press VOL+/- button to select a channel number and press CH+/- button to move to SEARCH, then repeat the fourth step.

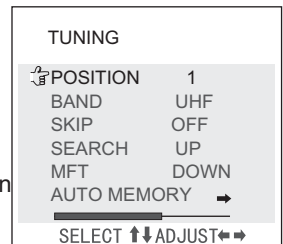

## MFT

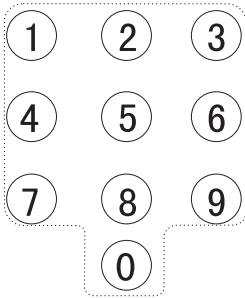
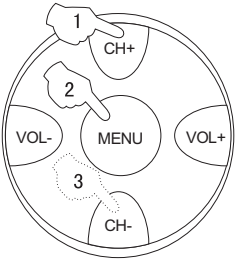

Direct-digit Choosing Button

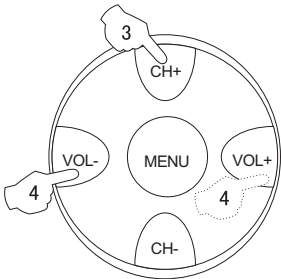

### MFT(manual fine tune)

When you can't get a satisfactory picture and audio effect, you can fine tune to obtain.

1. Press CH+/- button or the Direct-digit Choosing button to select a channel directly (take channel 1 for example).



2. Press MENU button, until TUNING appears on the screen.

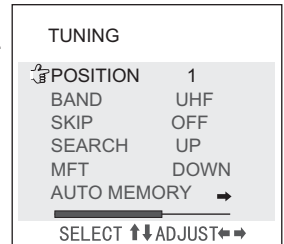

3. Press CH+/- button and move the indicator( $\frac{1}{2}$ ) to MFT.

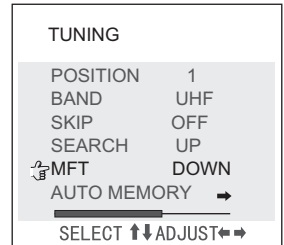

4. Press VOL+/- button repeatedly to fine tune, until the picture and the sound become satisfactory.

- VOL- button is used to search the lower frequency channel.
- VOL+ button is used to search the higher frequency channel.

# Tuning(continued)

## Skip

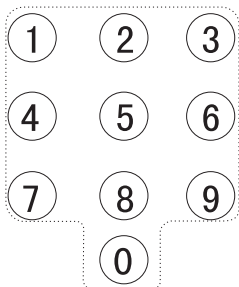

Direct-digit Choosing Button

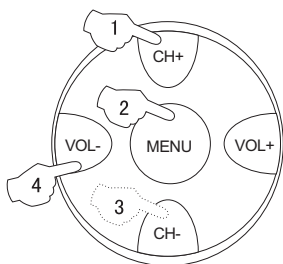

## Skip

After the programs are presetted, you can skip some programs so that to select your favorite channels only.

1. Press CH+/- button or Direct-digit Choosing button to select a channel directly (take channel 1 for example).

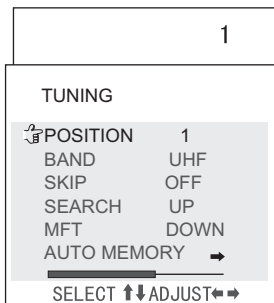

2. Press MENU button, until TUNING appears on the screen.

3. Press CH+/- button and move the indicator( ) to SKIP.

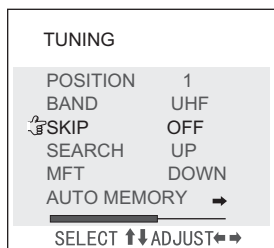

4. Press VOL+/- button to set it ON.

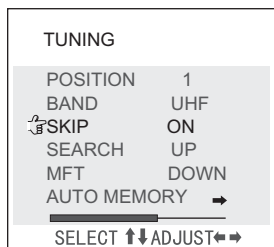

5. Press MENU button to close the menu. When you select channels with CH+/- button, this channel will be skipped. However, you can also use the Direct-digit Choosing button on the remote control to select this channel directly.

## If you want to recover the skipped channel

1. Use Direct-digit Choosing button to select the number of the channel to be recovered.
2. Do the above steps again.
3. Press VOL+/- button to set SKIP OFF.

# Adjusting the Picture and the Sound

## Multiple picture modes

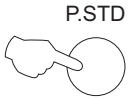

### How to select the picture mode

You may select the mode you want from the five preset modes and one individual mode.

Press the P. STD button to select a mode you like. DYNAMIC PICTURE, STANDARD PICTURE, MILD PICTURE, MEMORY, PICTURE MUTE and COLOR MUTE, totally six picture modes can be selected alternately.

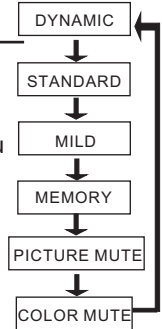

MODE	PICTURE QUALITY
DYNAMIC	BRIGHT COLOR
STANDARD	MEDIUM COLOR AND BRIGHTNESS
MILD	LOW COLOR AND BRIGHTNESS
MEMORY	SET BY YOURSELF
PICTURE MUTE	NO PICTURES
COLOR MUTE	BLACK AND WHITE

If the picture mode is set to PICTURE MUTE or COLOR MUTE, it will autorenew to MEMORY mode when you restart your TV set.

### Set the parameter of MEMORY

1. Press MENU button, until PICTURE appears on the screen.

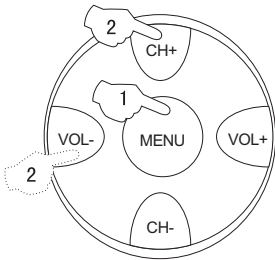

PICTURE	
CONTRAST	100
BRIGHT	50
COLOR	50
SHARP	50
B.B	ON
SELECT ↑↓ADJUST←→	

2. Press CH+/- button, move the indicator ( ) to the option you want to adjust, then press VOL+/- button to do the adjustment. Then the parameter will be automatically stored in MEMORY option.

OPTION	VOL+	VOL-
CONTRAST	STRONG	WEAK
BRIGHT	BRIGHT	DARK
COLOR	THICK	LIGHT
SHARP	SHARP	SOFT

# Adjusting the Picture and the Sound

(continued)

## Multiple Sound Modes



### How to select the sound mode

You can quickly select your most favored sound mode from the following three kinds of modes.

Press the S.STD button to select the sound quality that you want. NORMAL VOL, HIGH VOL and LOW VOL can be selected in turn (their parameter may be adjusted due to your need).

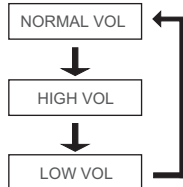

### Setting the sound

This function can let you regulate the volume to the preconcerted parameter quickly (such as the NORMAL VOL, HIGH VOL or LOW VOL).

1. Press MENU button, until FUNCTION 1 appears on the screen.

FUNCTION 1	
LANG.	ENGLISH
CURTAIN	III
LOW VOL	00
NORMAL VOL	00
HIGH VOL	00
VOL STORE	OFF
SELECT ↑↓ ADJUST ↔	

2. Press CH+/- button, move the indicator (the arrow) to the HIGH VOL, then press VOL+/- button to adjust the parameter you expect. With the same method, you can adjust the parameter of the NORMAL VOL or the LOW VOL.

FUNCTION 1	
LANG.	ENGLISH
CURTAIN	III
LOW VOL	00
NORMAL VOL	00
HIGH VOL	00
VOL STORE	OFF
SELECT ↑↓ ADJUST ↔	

- Suppose the LOW VOL is A, NORMAL VOL is B, HIGH VOL is C, then that will be:  
 $0 \leq A \leq B \leq C \leq 100$

- When adjusting the three modes, you should press them in proper order as HIGH VOL, NORMAL VOL, LOW VOL.

3. Press the S.STD button repeatedly to select the different sound setting modes.

### Volume store

When the VOL STORE (as above chart) is set ON, the sudden change of the volume can be avoided when you change the channel (only the pre-50 channels volume).

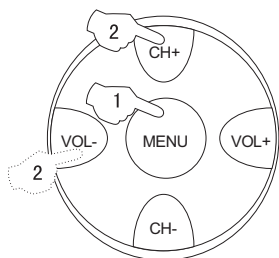

# Adjusting the Picture and the Sound

(continued)

## S.C.C, count and mute

### How to use the S.C.C(soft change channel)

- This TV set provides you with the function of S.C.C. When it is set "ON", the picture will fade in and fade out when the channel is changed.

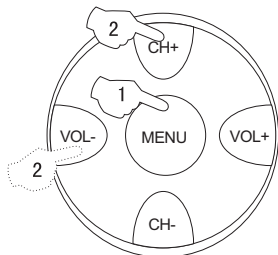

1. Press MENU button, until FUNCTION 2 appears on the screen.

FUNCTION 2	
SUBMARINE	→
POS.EX.	→
S.C.C	OFF
COUNT	0:00

SELECT ↑↓ ADJUST ←→

2. Press CH+/-button, move the indicator() to the S.C.C, then press VOL+/-button to set it ON or OFF.

### How to use the COUNT function

- This TV set provides you with the function of COUNT, if you want to know how long your TV set has been used, you can press MENU button, and find FUNCTION 2, then you can know the time the TV has been on(count from 0 after 100,000 hours).
- The time displayed is the total time when you watch the TV(time of standby status will not be included), the number cannot be altered through operating by the remote control or on the TV set.

### How to use the MUTE function

When you want to pay attention to the environment or answer a telephone, or to meet guests, using the mute function is very convenient.

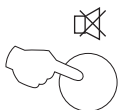

1. Press button, a sign will appear at the button left corner of the screen, and the sound of the TV set is cutoff.

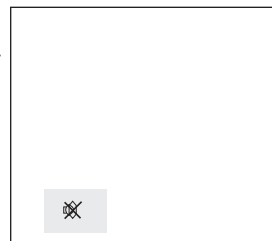

2. In order to recover the sound, press button again or press VOL+/-button.



# Setting the Timer

- This TV set provides you with three timer functions such as timer on, timer off and sleep off.

## Timer off

### Timer off

Using this function can turn the TV set automatically into standby status at the preconcerted time.

1. Press MENU button, until TIMER appears on the screen.

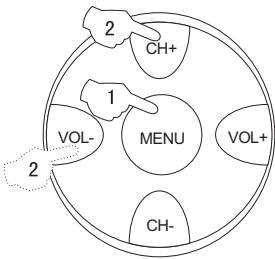

TIMER	
OFF TIMER	OFF
	19:00
ON TIMER	OFF
	22:00
POS	0
CLOCK	1:40
APPOINTMENT	→
SELECT	↑↓ADJUST←→

2. Press CH+/- button, move the indicator() to OFF TIMER, then press VOL+/- button to set it ONCE , EVERY, or OFF.

TIMER	
OFF TIMER	ONCE
	19:00
ON TIMER	OFF
	22:00
POS	0
CLOCK	1:40
APPOINTMENT	→
SELECT	↑↓ADJUST←→

3. Press CH- button, move the indicator() to the next row. Then, press VOL+/- button to set the time.

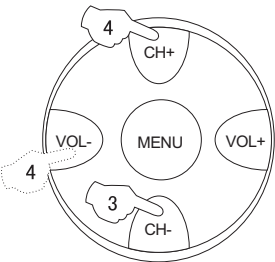

TIMER	
OFF TIMER	ONCE
	19:30
ON TIMER	OFF
	22:00
POS	0
CLOCK	1:40
APPOINTMENT	→
SELECT	↑↓ADJUST←→

4. Press CH+/- button, move the indicator() to CLOCK, press VOL+/- button, and you can set the time (It will be the standard of the clock of TIMER ON/OFF).

TIMER	
OFF TIMER	ONCE
	19:30
ON TIMER	OFF
	22:00
POS	0
CLOCK	1:40
APPOINTMENT	→
SELECT	↑↓ADJUST←→

# Setting the Timer (continued)

## Sleep timer and timer on

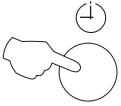

### Sleep timer

Using this function, the TV set can be changed into the standby status after a period of preset time from when this function is activated.

1. The utmost time for this function is 120 minutes, and the time interval is 10 minutes. There are totally 12 kinds of off-time.

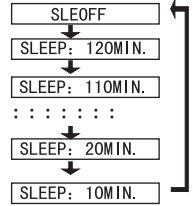

2. Press the button repeatedly, the screen will show in turn as the right form.

### Timer on

When this function is used, the TV set can automatically turn the power on at the preset time in the standby status and display the preset program.

1. Press MENU button, until TIMER appears on the screen.

2. Press CH+/- button, move the indicator() to the ON TIMER, then press VOL+/- button to set it ONCE , EVERY or OFF.

TIMER	
OFF TIMER	EVERY 19:00
ON TIMER	EVERY 22:00
POS	0
CLOCK	1:40
APPOINTMENT	→
SELECT	↑↓ADJUST←→

3. Press CH- button, move the indicator() to the below. Then, press VOL+/- button to set the time.

4. Press CH+/- button, move the indicator() to POS 0, press VOL+/- button to set the channel with which the TV is turned on (take 5 for example).

TIMER	
OFF TIMER	EVERY 19:00
ON TIMER	EVERY 22:00
POS	5
CLOCK	1:40
APPOINTMENT	→
SELECT	↑↓ADJUST←→

5. Press CH+/- button, move the indicator() to CLOCK, press VOL+/- button, and you can set the time (same as TIMER OFF and it will be the standard of the clock of TIMER ON/OFF).

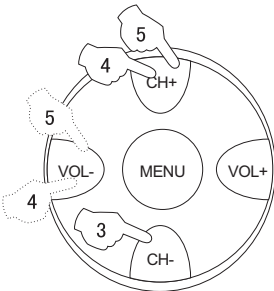
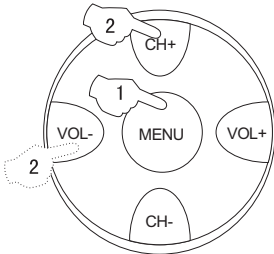

# Setting the Timer (continued)

- The channels appointment function can help you conveniently preset as many as six programs at a time. At the preset time, the TV set will automatically change to the preconcerted channel. If two or more programs are set in a same time, the last channel number will be selected.

## Channels appointment

### Channels appointment

1. Press MENU button, until TIMER appears on the screen.

2. Press CH+/- button, move the indicator (⏰) to CLOCK, press VOL+/- button, and you can set the time (same as TIMER OFF and it will be the standard of the clock of APPOINTMENT).

3. Press CH+/- button, move the indicator (⏰) to APPOINTMENT, then press VOL+ button to enter the sub-menu.

4. Press VOL+/- button to set the channel number you want (e.g. 100).

5. Press CH- button to enter the TIME item. Press VOL+/- button to set the time.

- Repeatedly press VOL+/- button, the time changes with a rate of one minute;
- Press the button without releasing, the time changes with a rate of ten minutes.

6. Press the CH- button, and follow the instructions of step 4 and 5, you can do the setting of the next channel.

7. Press DISP button to exit the TIMER menu.

- At the preset time, the TV set will automatically change to the preconcerted channel;
- This function is available only when the TV set is on, and it cannot be used in the status of standby or power off.

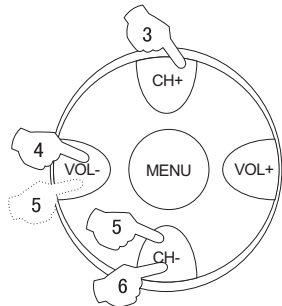
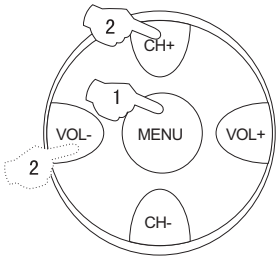

TIMER	
OFF TIMER	EVERY 19:00
ON TIMER	EVERY 22:00
POS	0
⏰ CLOCK	1:40
APPOINTMENT	→
SELECT	↑↓ADJUST←→

APPOINTMENT	
POS	TIME
⏰100	OFF
000	OFF
000	OFF
000	OFF
000	OFF
000	OFF

APPOINTMENT	
POS	TIME
⏰100	OFF
000	OFF
000	OFF
000	OFF
000	OFF
000	OFF

APPOINTMENT	
POS	TIME
⏰100	12:58
000	OFF
000	OFF
000	OFF
000	OFF
000	OFF



# Setting the other Function(continued)

## Curtain function and calendar display

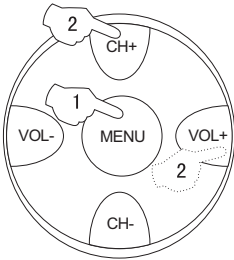

### How to use the Curtain function

- This TV set provides three types of Curtain function for you to select.





1. Press the MENU button, until the FUNCTION 1 appears on the screen.

2. Press CH+/-, and move the indicator(  ) to CURTAIN, then press VOL+ to select from I, II and III.

I: curtain

II : fade in and fade out

III: mixed I and II

FUNCTION 1	
LANG.	ENGLISH
 CURTAIN	III
LOW VOL	00
NORMAL VOL	00
HIGH VOL	00
VOL STORE	OFF
SELECT   ADJUST  	

### How to use the CALENDAR function

- This TV set has been designed to store the calendar from the year 1901 to 2050.

#### CALENDAR

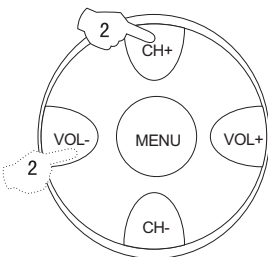

1. Press the CALENDAR button and then the calendar will appear on the screen(Press the CALENDAR button again to conceal the display).

OCT 2002						
SU	MO	TU	WE	TH	FR	SA
		1	2	3	4	5
6	7	8	9	10	11	12
13	14	15	16	17	18	19
20	21	22	23	24	25	26
27	28	29	30	31		
YEAR   MONTH  						

2. Press CH+/- button to adjust the YEAR, press VOL+/- button to adjust the MONTH.

# Setting the other Function(continued)

- The function of channel exchange will enable you to exchange any two programs and you can conveniently adjust the order of the programs due to your own need.

## Channel exchange

### Channel Exchange

(for example, to change between channel1 and 9 )

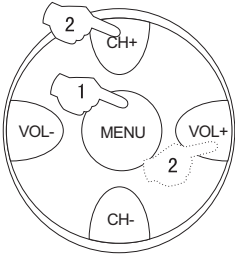

1. Press MENU button, until FUNCTION 2 appears on the screen.

FUNCTION 2		
	SUBMARINE	→
	POS.EX.	→
	S.C.C	OFF
	COUNT	0:00
SELECT ↑↓ADJUST←→		

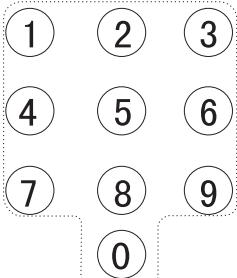

Direct-digit Choosing Button

2. Press CH+/- button, move the indicator() to POS.EX., Then press VOL+ button to enter the sub-menu.

- The number shown in EX.POS1 and EX.POS2 is the number of the present channel.

	POS.EX.	
	EX.POS1	1
	EX.POS2	1
	EXCHANGE	?
	RETURN	→

3. Press CH+/- button, move the indicator() to EX.POS2, then press VOL+ button to set the channel number to 9.

	POS.EX.	
	EX.POS1	1
	EX.POS2	9
	EXCHANGE	?
	RETURN	→

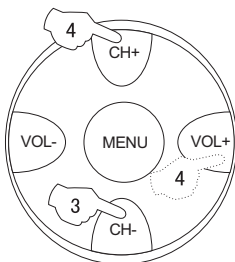

4. Press CH+/- button, move the indicator() to EXCHANGE, then press VOL+ button to confirm. Then the programs of the two channel will be exchanged.

		9
--	--	---

# Setting the Lock

- This TV set provides you with the LOCK function, you can choose it due to your need to protect your TV set.

## Changing your password

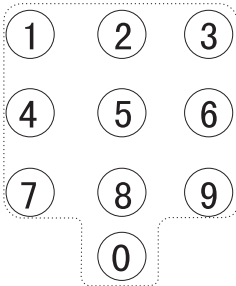
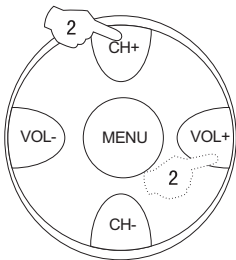
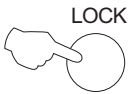

Direct-digit Choosing Button

### Changing your password

This TV set can set a four digit password, the original one is 0000, if you want to reset it, please follow the instructions below.

1. Press LOCK button, the screen will show as the form on the right.

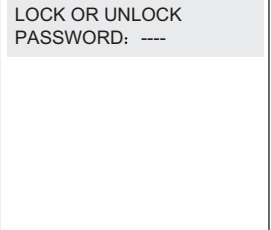

2. Press the 0 button four times and enter the menu of LOCK setting. Press CH+/- button and move the indicator (the arrow) to CHANGE PASS., and press VOL+ button to enter the sub-menu of change password.

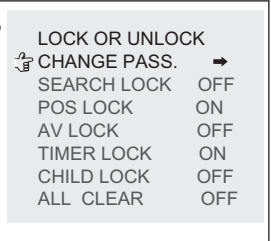

3. Press the Direct-digit Choosing button and input a four-digits password.

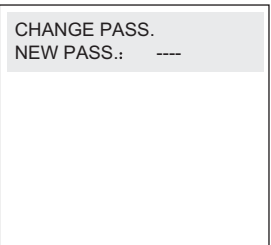

4. After inputting the new password, return to the original status as shown on the right form, then, you can input the new password to enter the menu of LOCK setting.

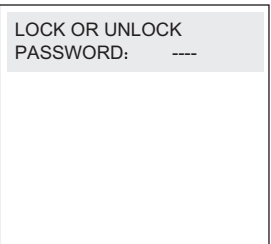

# Setting the Lock(continued)

## Setting the Lock

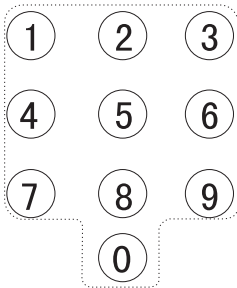
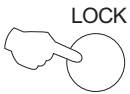

Direct-digit Choosing Button

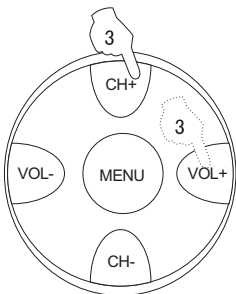

### Setting the Lock

There are SEARCH LOCK, POS LOCK, AV LOCK, TIMER LOCK and CHILD LOCK five lock setting, you can set it due to your need.

1. Press the LOCK button, the screen will show as the form on the right.

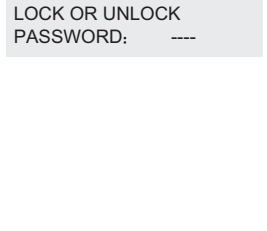

2. Press the Direct-digit Choosing button 0 for four times( or input the password you set), and enter the menu of LOCK.

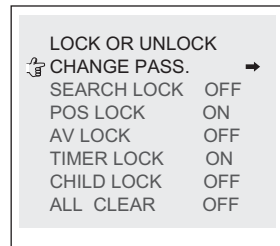

3. Press CH+/- button, move the indicator(  ) to SEARCH LOCK, then press VOL+ button to set it ON or OFF.

### Note:

1. When the CHANNEL or AV LOCK is set ON, the channel or av cannot be used, hence the screen will change into black and indicate that it has been locked. The TV set will be in the state of mute.
2. When the CHILD LOCK is set ON, if the buttons on the TV are pressed, it will indicate that the TV set is in the status of CHILD LOCK, and the buttons won't work.
3. When the SEARCH LOCK or the TIMER LOCK is set ON, if you want to enter the TUNING or TIMER menu, you will have to type the password.



# Game

- This TV set provides you with the SUBMARINE game, after entering the game, except the buttons that are appointed in the game( for example, the game button, VOL+/-and CH+/-, etc.)and the DC Standby button, the other buttons cannot be used.

## Game control buttons and method of playing the game

### Game control buttons

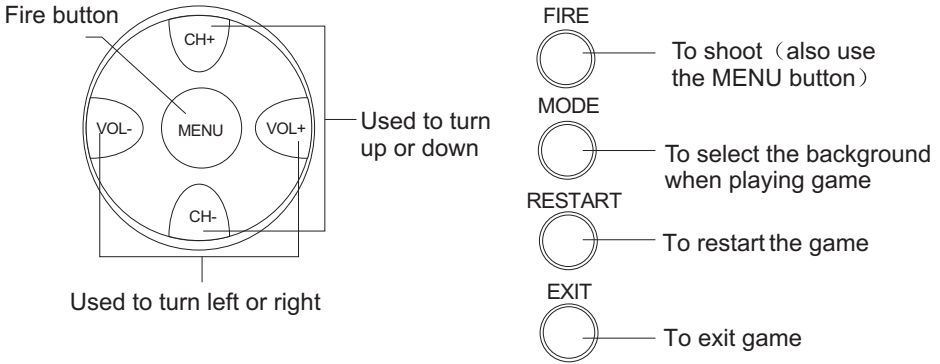

### Method of playing the game

1. Press MENU button until FUNCTION2 appears on the screen. Press the CH+/- buttons to select the SUBMARINE item. Then press VOL+ button to start the game.

2. On the screen, the submarine figures in yellow are operated by you. Press CH+/- and VOL+/- buttons to move the submarine up, down, left or right to change the position and avoid the attacks from submarines (in blue, green and purple) of enemy. Press MENU or FIRE button on the remote control to fire. You will get a mark of 100 when you destroy an enemy submarine or a shell. Specially, when you shoot down a red submarine appears on the top row, you will get a mark of 1000! Scores will be filed if the submarine of enemy is destroyed.

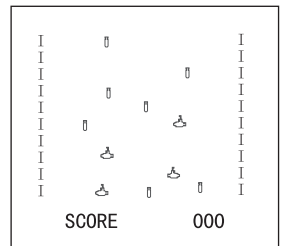

3. You can press the RESTART button to restart the game when it is GAME OVER or during the process of the game.

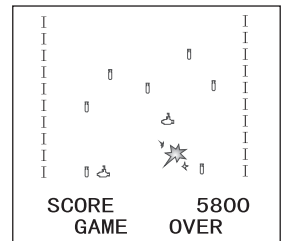

# Connecting Additional Equipments

- You can connect the DVD, VCR and stereo system to the AV output to enjoy a higher quality of picture and sound effect.

## Signal flow

- Ⓜ White (Audio left channel)
- Ⓡ Red (Cr and audio right channel)
- Ⓟ Blue (Cb)
- Ⓞ Green (Y)
- Ⓨ Yellow (Video)

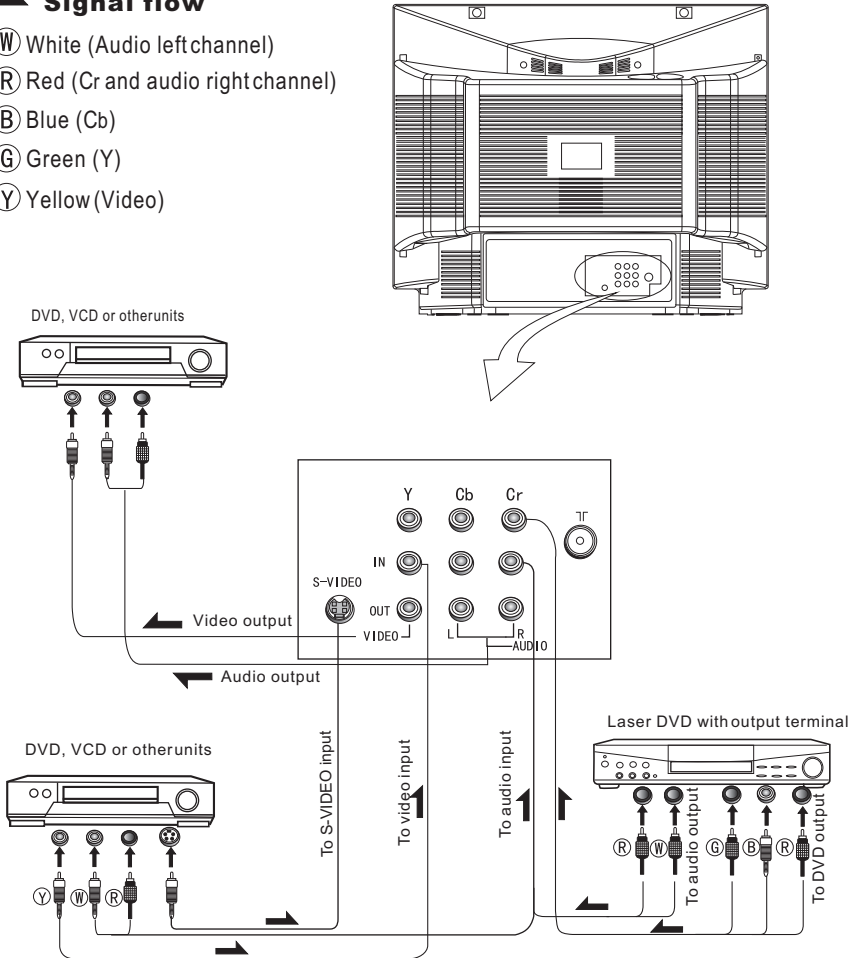

# Troubleshooting

- Before calling service personnel, please check the following chart for a possible cause to the trouble you are experiencing.

Symptom	Check these things
TV is not turned on	<ul style="list-style-type: none"> <li>• Be sure the power cord is plugged in.</li> </ul>
Good picture, no sound	<ul style="list-style-type: none"> <li>• The MUTE function may be used.</li> <li>• Adjust the volume of the TV set.</li> </ul>
Poor color / tint, good sound	<ul style="list-style-type: none"> <li>• The contrast, color and tint may be incorrectly adjusted.</li> <li>• If you change the direction of the TV while the TV is on, the picture may suffer from color shading. If so, turn off the TV and allow about 30 minutes to cool, then turn on the TV again.</li> </ul>
Spots appear on the screen	<ul style="list-style-type: none"> <li>• The broadcast signal may be jammed by other electrical sources such as cars, motorcycles, electric trains, high tension lines, neon signs, hair dryers.</li> </ul>
Lines appear on the screen	<ul style="list-style-type: none"> <li>• The broadcast signal may be jammed by other TV receivers, personal computers, and TV games, as well as interference from radio stations.</li> </ul>
Double images or ghosts	<ul style="list-style-type: none"> <li>• Interference may be due to broadcast waves reflected from mountains or buildings.</li> <li>• Check if the direction of the antenna is changed.</li> </ul>
Snowy picture or black screen	<ul style="list-style-type: none"> <li>• The antenna may be disconnected or falling out.</li> <li>• Check if the direction of the antenna is changed.</li> </ul>
Remote control does not work	<ul style="list-style-type: none"> <li>• The batteries in the remote control may be exhausted.</li> <li>• The batteries may be improperly installed.</li> <li>• Check if there are obstacles between the remote control and the remote (infrared ray) receiver.</li> <li>• Check if there is strong light interference around the remote (infrared) receiver.</li> <li>• Check if the main power is ON.</li> </ul>

## The following conditions are not troubles

Clacking noise inside the receiver	<ul style="list-style-type: none"> <li>• It may result from the expansion of the shell caused by a temperature change. This will not affect the picture and sound quality.</li> </ul>
Uneven colour in a certain portion of the screen	<ul style="list-style-type: none"> <li>• If the picture is too bright, this may occur according to the nature of the pictures. Reduce the contrast, it may resume to normal.</li> </ul>

### CAUTION

In case of problems, have your TV serviced by qualified personnel. Never attempt to service the set yourself since opening the cabinet may expose you to dangerous voltage or other hazards.

## Specifications

- The specifications offered you here are only for reference and, with the improvement of the products ,there may be some different between the description and the practicality.

### Specifications

Model	25T3A / 25F3A / 25T3A-T / 25F3A-T
Colour system	PAL、SECAM、AV NTSC3.58、NTSC4.43
Sound system	BG、DK
Picture tube	25"colour picture tube(the viewable dimension is 59cm)
Sound output power	3W
Power requirements	160V-250V~ 50/60Hz
Power consumption	≤ 120W
Dimension	645 (Width) x532 (Depth) x540 (Height) (mm)
Accessories	Remote control X1 Owner's manual X2 Battery(AA) X2

### NOTE

Design and specifications are subject to change without notice.  
The dimension in this manual is a approximation.

# Haier