

# iLuv™

## Portable Multimedia Tablet Style DVD Player with 8.4" Active-Matrix TFT LCD Screen



**Instruction Manual**

**Model: i1155**





**Please read this manual carefully before operating and  
save it for future reference.**

**Have a question? Please visit [www.i-Luv.com](http://www.i-Luv.com)**



**USER SAFETY GUIDE**

**IMPORTANT SAFETY PRECAUTIONS**

	<div style="background-color: #cccccc; padding: 5px; display: inline-block;"><b>CAUTION</b></div> <b>RISK OF ELECTRIC SHOCK</b> <b>DO NOT OPEN</b>	
	<p>The lightning flash with an arrowhead symbol within an equilateral triangle is intended to alert the user of the presence of un-insulated “dangerous voltage” within the unit’s cabinet that may be of sufficient magnitude to constitute a risk of electric shock.</p>	
	<p>The exclamation point within an equilateral triangle is intended to alert the user of the presence of important operating, maintenance and servicing instruction in the manual accompanying the unit.</p>	

**WARNING:** To prevent fire or shock hazard, do not expose this appliance to rain or moisture.

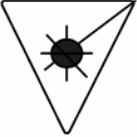
	<p><b>CLEANING</b>                  Always disconnect unit from power supply before attempting to clean it. Use soft cloth moistened with soapy water, and wipe gently. Do not use solvents or abrasive materials.</p>	
<div style="border: 1px solid black; padding: 5px; margin-bottom: 10px;">                     CLASS 1 LASER PRODUCT                      LUOKAN 1 LASERLAITE                      KLASS 1 LASERAPPARAT                 </div> 	<p><b>LASER SAFETY</b>                  This unit uses laser technology. Only a qualified professional should remove the cover or attempt to service this device, due to possible eye injury.</p> <p><b>CAUTION – CLASS 1 LASER PRODUCT</b>                  Use of controls adjustments and/or performance of procedure other than specified herein may result in hazardous radiation exposure.</p> <p><b>DANGER</b>                  Invisible laser radiation when open and interlock failed or defeated. Avoid direct exposure to beam. <b>CAUTION: HAZAROUS LASER RADIATION WHEN OPEN AND INTERLOCK DEFEATED.</b></p>	

## USER SAFETY GUIDE

### IMPORTANT SAFETY PRECAUTIONS



#### INSTRUCTIONS ON ENVIRONMENT PROTECTION

Do not dispose of this product in the usual household garbage at the end of its life cycle; bring it to a collection point for the recycling of electrical and electronic appliances. This symbol on the product means the instructions for use or the packing will inform about the methods for disposal. The materials are recyclable as mentioned in its marking. By recycling, material recycling, or other forms of re-utilization of old appliances, you make an important contribution to protect the environment. Please inquire at your local community administration for the authorized disposal location.

### IMPORTANT SAFETY WARNINGS

1. Before using the player, please ensure that your local AC voltage is suitable for this unit.
2. To prevent fire or electric shock, do not expose the unit to water, rain, or moisture.
3. Never attempt to open the cabinet. Dangerous high voltages are present in the unit.
4. Always refer servicing to a qualified technician.

### IMPORTANT SAFETY INSTRUCTIONS

1. **READ INSTRUCTIONS** – All the safety and operating instructions should be read before the appliance is operated.
2. **RETAIN INSTRUCTIONS** – The safety and operating instructions should be retained in a secure place for future reference.
3. **HEED WARNINGS** – All warnings on the appliance and in the operating instructions should be observed.
4. **FOLLOW INSTRUCTIONS** – All operating and use instructions should be followed.
5. **WATER AND MOISTURE** – The appliance should not be used near water. For example: near a bathtub, kitchen sink, laundry tub, and/or swimming pool.
6. **VENTILATION** – The appliance should be situated so that its location and position does not interfere with its proper ventilation. For example, the appliance should not be situated on a bed, sofa, rug or similar surface that may block the ventilation openings; or, be placed in a built-in installation, such as a bookcase or cabinet that may impede the flow of air through the ventilation openings.
7. **HEAT** – The appliance should be situated away from heat sources such as radiators, heat registers, stoves, or other appliances (including amplifiers) that produce heat.
8. **POWER SOURCES** – The appliance should be connected to a power supply only of the type described in the operating instructions or as marked on the appliance itself.
9. **POWER CORD PROTECTION** – Power supply cords should be routed so that they are not likely to be walked on or obstructed by items placed on or against them. Pay particular attention to cords at plugs, convenience receptacles, and the point at which they connect to the appliance.
10. **CLEANING** – The appliance should only be cleaned with a dry cloth.

#### FCC NOTICE (USA)

This device complies with Part 15 of the FCC Rules. Operation is subject to the condition that this device does not cause harmful interference.

**Note: Changes or modifications not expressly approved by the party responsible for compliance could void the user's authority to operate the equipment.**

## USER SAFETY GUIDE

### IMPORTANT SAFETY INSTRUCTIONS – CONTINUED

11. **NONUSE PERIODS** – When the appliance is to be left unused for an extended period of time, unplug from outlet.
12. **OBJECT and LIQUID ENTRY** – Care should be taken so that objects do not fall and liquids are not spilled into the device's openings.
13. **DAMAGE REQUIRING SERVICE** – The appliance should be serviced by qualified service professional when:
  - a. The power supply cord or plug has been damaged.
  - b. Objects have fallen into, or liquid has been spilled into the appliance's apertures.
  - c. The appliance has been exposed to rain.
  - d. The appliance has been dropped and suffered damage.
  - e. The appliance does not appear to operate normally, or exhibits a change in performance.
14. **SERVICING** – The user should not attempt to service the appliance beyond what is described in the user's operating instructions. All other servicing should be referred to qualified service professional.
15. **BATTERY USAGE** – To prevent battery leakage, which may result in bodily injury, property damage or damage to the unit, follow these instructions:
  - a. Install all batteries correctly according to the polarity (+ -) as marked on the unit.
  - b. Do not mix old and new batteries, carbon and alkaline, etc.
  - c. Remove batteries from the unit when the device will not be used for an extended period of time.
16. **LEAD AND MERCURY** – This product may contain lead and/or mercury. Disposal of these materials may be regulated by your local authorities due to environmental considerations. For more detailed disposal or recycling information, please contact your local authorities or the EIA (Electronic Industries Alliance) – <http://www.eiae.org>

#### IC NOTICE (Canada)

Since digital circuitry may cause interference to other radio or television tuners nearby, switch this unit off when not in use or move it away from the affected radio/television tuner.

**Note:** This digital apparatus does not exceed the Class B limits for radio noise emissions from digital apparatus as set out in the Radio Interference Regulations of Industry Canada. These limits are designed to provide reasonable protection against harmful interference in a residential installation. This equipment generates, uses, and can radiate radio frequency energy and, if not installed in accordance with these instructions, may cause harmful interference to radio communications. However, there is no guarantee that interference will not occur in a particular installation. If this equipment does cause harmful interference to radio or television operation (which can be determined by turning the equipment off), the user is encouraged to try to correct the interference by one of more of the following measures:

- Reorient or relocate the receiving antenna.
- Increase the separation between the equipment and receiver.
- Connect the equipment into an outlet on a circuit different from that to which the receiver is connected.

Consult the dealer or an experienced radio/TV technician for help.

## TABLE OF CONTENTS

### GETTING STARTED

Compatibility .....	8
MP3 Information.....	8
General features .....	9
Location of controls on the remote control .....	10
Location of controls on the main unit .....	11
How to make your player stand .....	12
First time use of remote control .....	12
Remote control battery installation .....	12
Using the AC adapter .....	12
Using the cigarette lighter (car) adapter .....	12
Charging your DVD player .....	13
Low battery indication .....	13
Charging your iPod .....	13
Connecting headphones .....	14
Connecting the DVD player to a TV set by AV cable .....	14
Connecting the DVD player to a TV set by S-Video cable .....	14

### BASIC OPERATION

Watching your iPod videos on the 8.4" LCD screen .....	15
Watching your iPod videos on your TV .....	16
Viewing your iPod photos on the 8.4" LCD screen.....	17
Viewing your iPod photos on your TV.....	17
Playing a DVD / VCD / Audio CD / MP3 CD .....	17
Playing an MP3 CD .....	18
Playing a JPEG CD .....	19

### OPERATIONAL FEATURES

Panel key lock .....	20
Display Feature .....	20
Invalid icon .....	20
LCD screen function .....	20
Title feature.....	20
DVD menu feature .....	20
Audio feature .....	20
Subtitle feature .....	21
Mute function.....	21

# TABLE OF CONTENTS

## OPERATIONAL FEATURES – CONTINUED

- Volume function..... 21
- Zoom function ..... 21
- Random function ..... 21
- Skip and search functions ..... 21
- Title / chapter search function ..... 21
- Title / time search function ..... 22
- Programmed playback ..... 22
- Repeat function ..... 22
- A-B repeat function ..... 23
- Multi-Angle viewing..... 23

## SETUP INSTRUCTIONS

- System setup..... 24
- Language setup..... 24
- Video setup..... 25
- Speaker setup ..... 25
- LCD Setting ..... 25

## CARE AND MAINTENANCE GUIDE

- Compact disc care..... 26
- Cleaning the unit ..... 26

## TROUBLESHOOTING GUIDE

- Q & A about the product..... 27

## SPECIFICATIONS

- Technical Information..... 29

**This product incorporates copyright protection technology that is protected by method claims of certain U.S. patents and other intellectual property rights owned by Macrovision Corporation and other rights owners. Use of this copyright protection technology must be authorized by Macrovision Corporation, and is intended for home and other limited viewing uses only, unless otherwise authorized by the Macrovision Corporation. Reverse engineering or disassembly is prohibited.**





**Apparatus claims of US Patent Nos. 4,631.603; 4,819.098; 5,315.448 and 6,516.132; licensed for limited viewing uses only.**





## GETTING STARTED

### COMPATIBILITY

	<p><b>AUDIO AND VIDEO</b></p>	<ol style="list-style-type: none"> <li>1. Disc Size: 12cm / 8cm</li> <li>2. Disc Type: DVD             <ol style="list-style-type: none"> <li>a. Single side, single layer</li> <li>b. Single side, double layer</li> <li>c. PAL / NTSC</li> </ol> </li> </ol>
	<p><b>AUDIO AND VIDEO</b></p>	<ol style="list-style-type: none"> <li>1. Disc Size: 12cm / 8cm</li> <li>2. Disc Type: SVCD / VCD</li> <li>3. Playback time 74 min./ 24 min. max</li> </ol>
	<p><b>AUDIO CD</b></p>	<ol style="list-style-type: none"> <li>1. Disc Size: 12cm / 8cm</li> <li>2. Disc Type: CD</li> </ol>
	<p><b>MP3 CD</b></p>	<ol style="list-style-type: none"> <li>1. Disc Size: 12cm / 8cm</li> <li>2. Disc Type: CD</li> <li>3. File Format: MP3 (MPEG 1 Audio Layer 3)</li> <li>4. Bit Rate: 32Kbps ~ 320Kbps</li> </ol>
	<p><b>DIGITAL MEDIA PLAYER</b></p>	<ol style="list-style-type: none"> <li>1. Made for iPod with video, third generation iPod nano, iPod classic only.</li> <li>2. iPod is a trademark of Apple Computer, Inc.</li> </ol>

### DISC ERROR

This DVD player has built-in error compensation circuits to correct minor defects in a disc. There are limits, however, to the amount of correction available. In some cases, the DVD player may skip some tracks, or parts of tracks, on a disc during disc play. This problem may be caused by defects (such as scratches) on the disc being played which are too large for the error compensation circuits to handle. If you encounter this problem, try a new disc before having this unit serviced. If the DVD player operates normally, the skipping problem is probably due to a defective disc.

**Note:** Only the above types of discs can be played on this unit. Some CD-R, CD-RW discs cannot be played depending on the condition of the disc.

### MP3 (MPEG 1 Audio Layer 3)

MP3, technically referred to as MPEG 1 Audio Layer 3, is a popular digital audio encoding and lossy compression format. This format was developed to reduce the amount of data (or audio information) required to represent audio, yet still reproduce audio in the same manner as the original uncompressed audio for most listeners.

## GETTING STARTED

Thank you for purchasing the i1155. Unpack the unit and make sure all the accessories are put aside so they will not be lost. We recommend that you retain the original carton and packaging materials for future use, should you transport or ship the unit in the future.

### **Portable Multimedia Tablet Style DVD Player with 8.4" Active-Matrix TFT LCD Screen**

#### **Features for Your iPod**

- Play video content of your iPod on the 8.4" widescreen TFT LCD
- Capable of outputting your favorite videos on your iPod to your TV
- Charge your iPod via i1155 using AC adapter or car adapter
- Integrated dock for your iPod with video (30GB, 60GB, 80GB), iPod classic (80GB, 160GB)
- Optional dock for your iPod nano 3<sup>rd</sup> Generation. (Sold separately)

#### **Features for DVD Player**

- Play DVD videos on the 8.4" widescreen TFT LCD
- Watch your favorite videos on your TV through S-Video or AV output
- Enhanced user interface with detailed controls
- Convenient OSD (On-Screen Display)
- Multiple subtitle, angle, and audio functions
- Fast motion playback and zoom operation
- Supports 3-way power sources
  - AC adapter
  - Car adapter
  - Built-in Li-Polymer rechargeable battery
- Playable Media: DVD / VCD / Audio CD / MP3 CD

#### **What's included?**

- 8.4" DVD player
- Remote control (battery included)
- AC adapter
- Car adapter
- AV cable (3.5 mm-to-RCA)
- Instruction manual
- Warranty card

\* The included power adapters must be connected to the main unit in order to charge your iPod.

## GETTING STARTED

### Location of Controls on the Remote Control

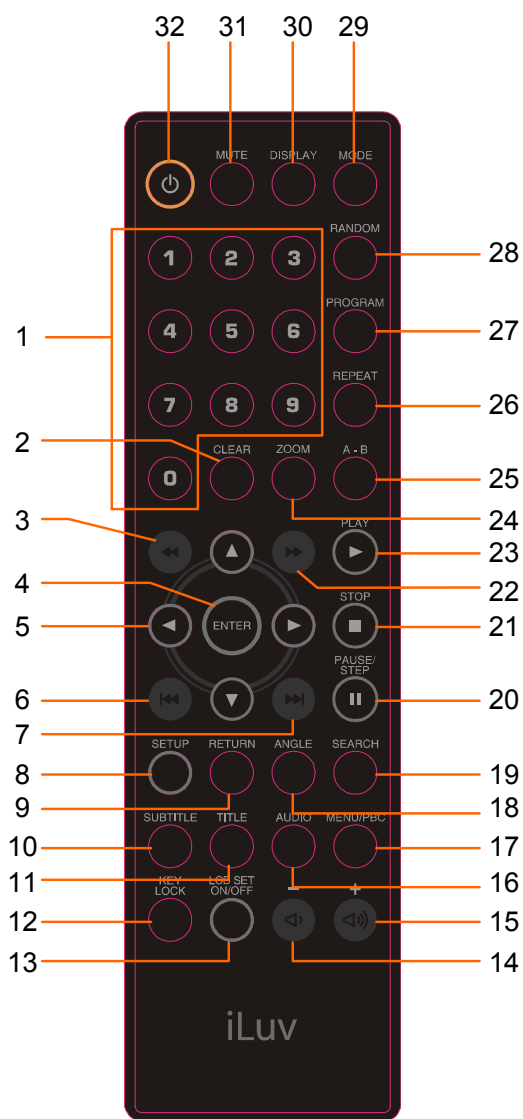

1. NUMBER 0 TO 9 BUTTONS
2. CLEAR BUTTON
3. SEARCH REVERSE BUTTON
4. ENTER BUTTON
5. NAVIGATION (◀ / ▶ / ▲ / ▼) BUTTON
6. SKIP REVERSE BUTTON
7. SKIP FORWARD BUTTON
8. SETUP BUTTON
9. RETURN BUTTON
10. SUBTITLE BUTTON
11. TITLE BUTTON
12. KEY LOCK BUTTON
13. LCD SET ON/OFF BUTTON
14. VOLUME DOWN BUTTON
15. VOLUME UP BUTTON
16. AUDIO BUTTON
17. MENU/PBC BUTTON
18. ANGLE BUTTON
19. SEARCH BUTTON
20. PAUSE / STEP BUTTON
21. STOP BUTTON
22. SEARCH FORWARD BUTTON
23. PLAY BUTTON
24. ZOOM BUTTON
25. A-B BUTTON
26. REPEAT BUTTON
27. PROGRAM BUTTON
28. RANDOM BUTTON
29. MODE BUTTON
30. DISPLAY BUTTON
31. MUTE BUTTON
32. STANDBY ON / OFF BUTTON

#### IMPORTANT NOTE

The included remote control can control your iPod.

**Point the remote control unit no more than 6m from the remote sensor and within about 30° of the front of the unit.**

## GETTING STARTED

### Location of Controls on the Main Unit

#### Right View

1. Mode/Key Lock Button
2. Volume Up Button
3. Volume Down Button
4. Phones Jacks
5. S-Video Jack (black)
6. Video Jack (yellow)
7. Audio Jack (white)

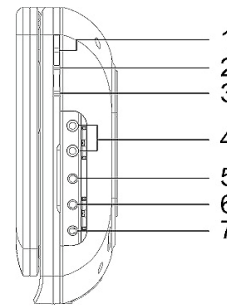

#### Front View

8. Power On/Off Switch
9. 8.4" TFT LCD Screen
10. iPod Dock Compartment
11. Navigation Up Control
12. Menu Control
13. Navigation / Skip Forward Control
14. Navigation Down Control
15. Play / Pause Control
16. Navigation / Skip Reverse Control
17. Setup Control
18. Disc / Dock Cover
19. Disc Mode Indicator
20. iPod Mode Indicator
21. Battery Indicator
22. Remote Control Sensor
23. Open Button

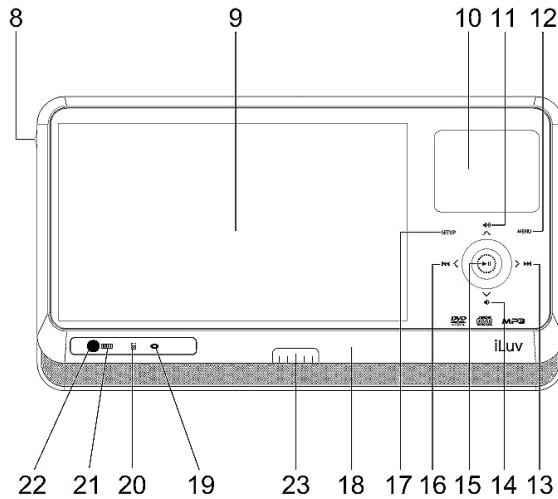

#### Back View

24. DC IN Jack
25. Holds for Desktop Stand
26. Desktop Stand

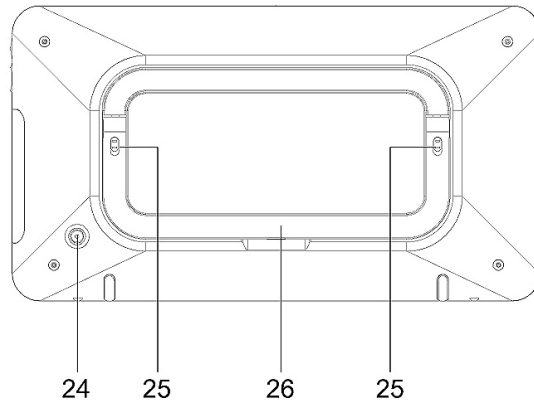

## GETTING STARTED

### How to Make Your Player Stand

Follow the illustrations below 4 step to make your player stand.

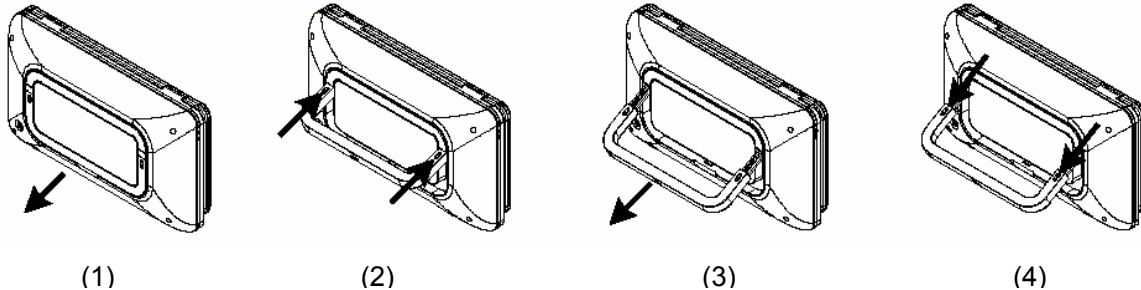

### First Time Use of Remote Control

The battery is pre-installed in the remote control with an insulation plate. Before operating the remote control, please pull out the insulation plate from the battery compartment.

### Remote Control Battery Installation

If the remote control does not work or the signal gets weaker, the battery might weak. In that case, please replace the battery.

1. Pull out battery holder as shown at right.
2. Place one battery (CR 2025) as shown at right. Match the polarity (+/-) of battery with the marks inside the unit.
3. Insert battery holder into its compartment as shown at right.

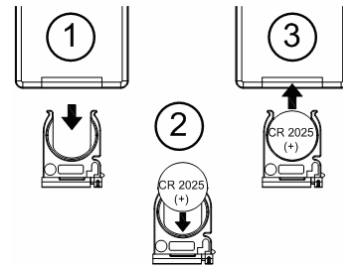

**Note:** Do not attempt to recharge, short-circuit, disassemble, heat, or throw batteries into a fire.

### Using the AC Adapter

1. Insert the DC plug at the end of the adapter cord into the **DC IN** jack on the back of the player.
2. Plug the other end into an AC wall outlet.

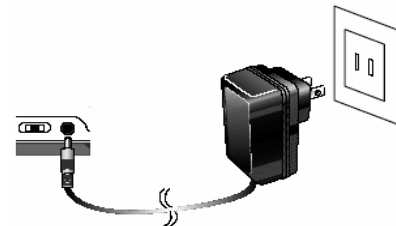

**Note:** Use ONLY the supplied AC adapter. Use with other AC adapters could cause damage. Remove both the DC plug and AC plug to disconnect the AC adapter when not necessary.

### Using the Cigarette Lighter (Car) Adapter

Plug the small end of the cigarette lighter (car) adapter into the **DC IN** jack and plug the other end into the cigarette lighter socket.



## GETTING STARTED

### Charging Your DVD Player

Before using this unit with the built-in Li-Polymer rechargeable battery, please **FULLY CHARGE THE BATTERY** first. If this is not done, discharging time will be short. The battery operate normally at maximum capacity after 4~5 times of charging and discharging. After a period of storage or non-usage for an extended period of time, please fully charge the battery again before using it. The battery is fully charged for approximately 2.5-3 hours after the AC adapter is connected.

1. Connect to the AC adapter according to the instructions in the section **Using the AC Adapter**.
2. Once the AC adapter is connected, the battery recharge will start. While the battery is charging, the **BATTERY** indicator on the front will light **RED**. When charging is complete, the **BATTERY** indicator will light **GREEN**.
3. Disconnect the AC adapter plugs from both the player and the AC outlet when charging is complete or not necessary.

**Note:** The built-in battery can be charged in both the power-on and power-off modes, in power-on mode, the charge time will be longer than power-off mode.

### Low Battery Indication

When using the rechargeable battery to play, the charge will eventually weaken. When the battery close to exhausted, the **BATTERY** indicator will begin to flash in red. To recharge the battery, refer to the instructions in the section **Charging Your DVD Player** above.

### Charging Your iPod

1. Insert your iPod into the dock carefully and close the dock cover.
2. Connect the supplied AC adapter to the unit. It will automatically charge your iPod.
3. Disconnect the AC adapter when not necessary.

## GETTING STARTED

### Connecting Headphones (not included)

Use 3.5 mm stereo headphones with this product.

**Warning:** Hearing experts have found that using headphones at high volume over an extended time may cause damage to or loss of hearing.

### Connecting the DVD Player to a TV Set by AV Cable

Use the AV cable (3.5 mm to RCA) to connect the DVD player to a TV set and amplifier. The yellow plug is used for Video.

The white plug and red plug are for Audio.

### Connecting the DVD Player to a TV Set by S-Video Cable (not included)

Use the S-Video cable (3.5 mm to DIN) to connect the DVD player to the TV set.

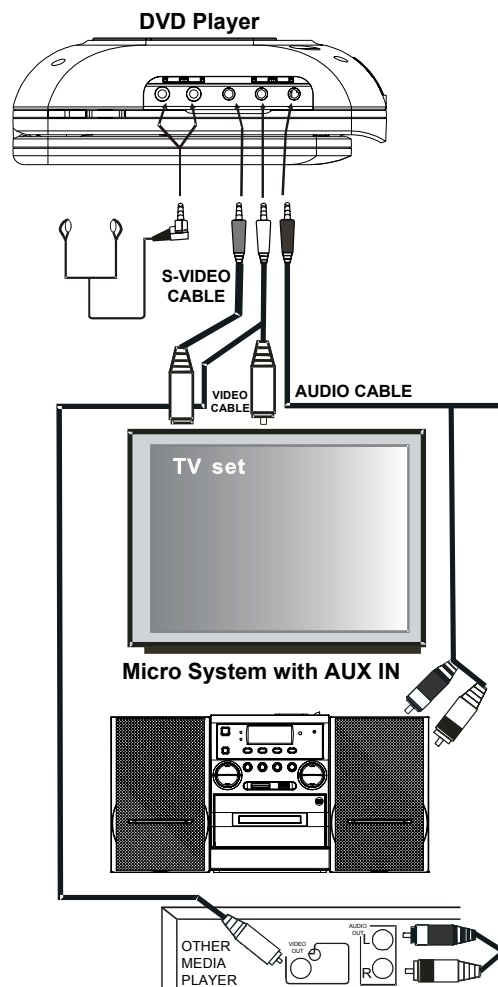

## BASIC OPERATION

### Watching Your iPod Videos on the 8.4" LCD Screen

To power the unit on, slide the **POWER** switch on the left side of the unit to the **ON** position.. To see your favorite iPod videos on the 8.4" LCD screen, follow the instructions below:

1. Before setting, insert your iPod into the dock carefully and close the dock cover.
2. Connect the AC adapter to the main unit and slide the **POWER** button on the left side of the main unit to the **ON** position.

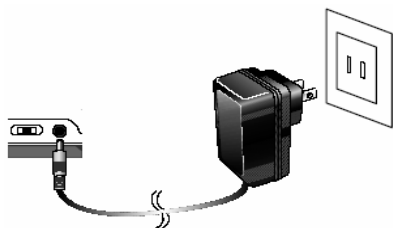

3. Press the **DVD/iPod** button to select iPod mode on right of the main unit.

4. On the menu screen of your iPod, select the "**Videos**" option.

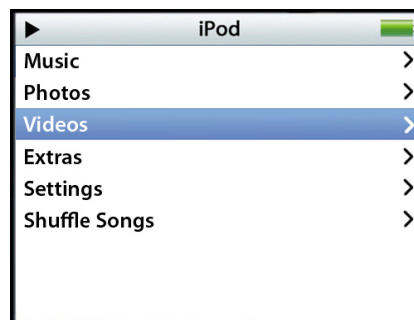

5. On the next menu screen, select the "**Video Settings**" option.

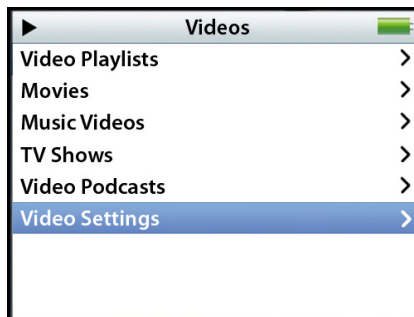

6. On the next menu screen, select the "**TV Out**" option and set it on.

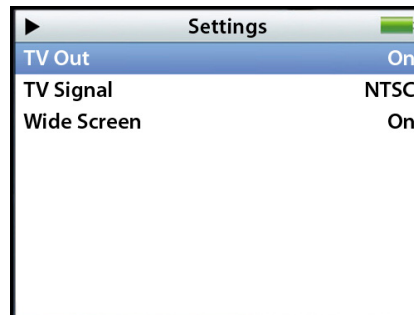



## BASIC OPERATION

### Watching Your iPod Videos on the 8.4" LCD Screen – Continued

7. Navigate the menu screen of your iPod to your favorite video by touching the MENU key and UP, DOWN keys, touch the SETUP key to select.
8. Play the video file and watch it on the 8.4" LCD screen. Use the iPod to open and control your desired songs, photos, and video files. The i1155 will then respond to the given command. Please note that i1155 and remote control can control your pod.

### Watching Your iPod Videos on Your TV

You can also watch your iPod videos on your TV through the AV output. To do so, follow the instructions below.

1. Connect the 3.5 mm plugs (mono for video and stereo for audio) of the supplied AV cable to the audio and video jacks located at the right of the i1155.
2. Connect the RCA plugs (yellow, white, red) of the AV cable to the audio and video input jacks on your TV. The yellow RCA plug is used for the video connection, and the white and red RCA plugs are used for the audio output.
3. Turn on your TV set and change it to the AV mode. Please refer to the user manual of your TV.
4. Follow the instructions in the section "**Watching Your iPod Videos on the 8.4" LCD Screen**" to play your iPod videos. Please note that the video quality displayed on your TV depends on the resolution of your video file. If your TV screen is bigger, you will see more image distortion.

## BASIC OPERATION

### Viewing Your iPod Photos on the 8.4" LCD Screen

To view your favorite iPod photos as a slideshow on the 8.4" LCD screen, follow the instructions below:

1. On the menu screen of your iPod, select the **"Photos"** option
2. On the next menu screen, select the **"Slideshow Settings"** option.
3. On the next menu screen, select the **"TV Out"** option and set it on.
4. Press the **MENU** button to return to the previous menu, and select the **"Photo Library"** option.
5. Press the **SETUP** key once. The picture will show on the LCD screen of your iPod. Press the **SETUP** touch key again to start slide show.

### Viewing Your iPod Photos on Your TV

You can also view your favorite iPod photos as a slideshow on your TV through the AV output.

To do so, follow the instructions below:

1. Follow instructions 1 to 3 in the section called **"Watching Your iPod Videos on Your TV."**
2. Follow the instructions in the section **"Viewing Your iPod Photos on the 8.4" LCD Screen"** to play your iPod photos as a slideshow. Please note that the photo quality displayed on your TV depends on the resolution of your photo file. If your TV screen is bigger, you may see more image distortion.

### Playing a DVD / VCD / Audio CD / MP3 CD

1. To power the unit on, slide the **POWER** switch to **ON** at the left of the main unit.
  - a. To select the type of power source, refer to the portion of the manual entitled, **GETTING STARTED.**

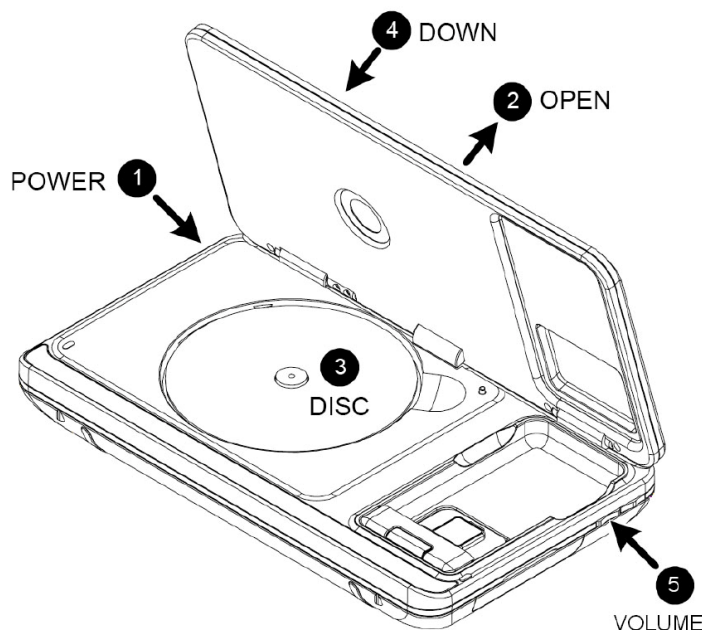

## BASIC OPERATION

### Playing a DVD / VCD / Audio CD / MP3 CD – Continued

2. Push the OPEN BUTTON to right side and catch the disc/dock cover hem to open the cover.
3. Place the disc with the label side facing up into the disc compartment. Hold the disc without touching either of its surfaces while placing it into the disc compartment.
4. Push the cover down to close and secure. The disc will start playback automatically.
  - a. If playing a DVD, the **MENU** options will appear on the LCD screen, depending on the DVD. Use the **NAVIGATION** (◀ / ▶ / ▲ / ▼) controls to select the **PLAY** option. Touch the **PLAY/PAUSE** control to play the disc.
  - b. If playing a VCD or Audio CD, the video or audio track will play automatically. If not, touch the **PLAY/PAUSE** (▶||) control to start playing.
  - c. For an MP3 disc, the disc reading time may be longer due to the large number of songs compiled onto one disc. Select a specific song and touch **PLAY/PAUSE** (▶||) control to play.
5. Adjust the volume to a comfortable sound level by pressing **VOLUME** controls.
6. Press the **STOP** (■) button once on remote control while playing a DVD and the indication **PRE STOP** will appear on the screen. The player then memorizes the point where you stopped. Touch the **PLAY/PAUSE** (▶||) control again to resume playing the movie from where it was stopped.
7. Touch and hold the **PREV** (||◀) or **NEXT** (▶||) key for 3 seconds to skip to previous or next track/chapter.
8. Press the **STOP** (■) button twice on remote control while playing a movie to completely stop playback.

### Playing an MP3 CD

To power the unit on, slide the **POWER** switch to on at the left of the main unit.

1. Loading a disc. The unit will load the disc and automatically display the contents of the disc on the screen while playing the first MP3 file. The files will then be played back one by one.
2. Touch the **NAVIGATION** controls (◀ / ▶) to select MP3 or PICTURE file.
3. Touch the **NAVIGATION** (◀ / ▶ / ▲ / ▼) controls to view and select the desired audio files.
4. Touch the **PLAY/PAUSE** control to confirm.
5. You can touch the **PAUSE** (||) control to interrupt playback, and touch the **PLAY** (▶) control to resume playback.

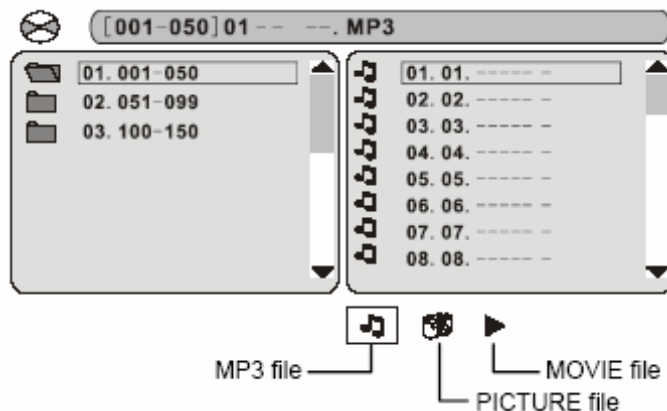

## BASIC OPERATION

### Playing a JPEG CD

Please note that graphic files must be saved in JPEG format (file extension .jpg). Otherwise, they will not be recognized. When a CD with JPEG files is inserted, a screen appears showing the folders and files contained on the CD.

1. Use the **NAVIGATION** (▲ / ▼) controls to select the desired folder and touch the **ENTER** control to see the files in the folder.
2. Use the **NAVIGATION** (▲ / ▼) controls to select the desired file. The selected picture will be shown as a thumbnail picture on the left frame. Touch the **PLAY** (▶) control to display the picture. It will also start a slide show of the pictures automatically until all pictures on the CD have been displayed one time.
3. Touch the **PAUSE** (||) control to hold the current picture on the screen. To continue the slide show, touch the **PLAY** (▶) control again.
4. Use the **SKIP** (◀/▶) buttons to move to the previous or next picture.
5. Press the **STOP** (■) button on remote control to stop the slide show and return to the menu folder.
6. Pressing the **REPEAT** button twice will display the current image constantly on the screen.
7. Press the **REPEAT** button again to repeat all pictures on current directory.
8. Press the **REPEAT** button again to repeat all pictures on the disc.
9. Press the **REPEAT** button again to cancel the repeat mode.

**Note:** When selecting the **REPEAT ONE** mode in the slide show, the selected picture will be displayed constantly. In this case, the **SKIP** (◀/▶) buttons will not advance to the next picture or return to the previous one. To skip to the next or previous picture, disable the **REPEAT ONE** mode.

## OPERATIONAL FEATURES

### Panel Key Lock

Press the **KEY LOCK** button on the remote control, or press and hold the **KEY LOCK** button on right side of the unit for three (3) seconds. The indication **KEY LOCK ON** will appear on the screen. This means that the function keys on the main unit and remote control are now disabled. To make all buttons function again, press the **KEY LOCK** button on the remote control, or press and hold the **KEY LOCK** button on right side of the unit for three (3) seconds again.

### Display Feature

Press the **DISPLAY** button to show the elapsed and remaining time of the playing disc. Each time the **DISPLAY** button is pressed, the displayed time mode will change on the screen as follows:

1. DVD: Chapter Elapsed ⇒ Disc Information ⇒ Chapter Remain ⇒ Title Elapsed ⇒ Title Remain ⇒ Display Off
2. VCD: Track Elapsed ⇒ Track Remain ⇒ Total Elapsed ⇒ Total Remain ⇒ Display Off
3. MP3 CD: Track Elapsed ⇒ Track Remain ⇒ Display Off

### Invalid Icon

The **INVALID KEY** indication will appear on the LCD screen if the corresponding function cannot be performed either on the inserted disc or in the selected mode. Please note that some functions depend on the disc type and the media on the disc.

### Title Feature

Press the **TITLE** button to make the title menu on the disc appear on the screen. Use the **NAVIGATION** (◀ / ▶ / ▲ / ▼) buttons to select the desired option and press the **ENTER** button to confirm. Some discs may not support this feature.

### Menu/PBC Feature

When playing a DVD, press the **MENU/PBC** button to go to the main menu of the disc. Use the **NAVIGATION** (◀ / ▶ / ▲ / ▼) buttons to select the desired option on the main menu and press **ENTER** to confirm. Some discs may not support this function.

When playing a VCD, press the **MENU/PBC** button to activate the PBC feature. When playing a VCD with PBC function, you can enjoy the interactive features of VCD. By turning on this function, desired tracks can be selected by pressing the **NUMERIC** buttons. This feature is enabled only when a VCD 2.0 disc supports the PBC feature. After selecting a track, press the **ENTER** button to play.

### Audio Feature

The **AUDIO** button will allow you to change the audio language from the one selected as the primary language on the disc if the disc supports this option. Also press the **AUDIO** button to cycle through the audio modes while playing a VCD. The audio modes vary depending on the disc inserted but include **STEREO**, **MONO L**, **MONO R**, etc.

## OPERATIONAL FEATURES

### Subtitle Feature

Press the **SUBTITLE** button to select a subtitle language. To turn off the subtitles, press the **SUBTITLE** button repeatedly. Some discs may not support this feature.

### Mute Function

Press the **MUTE** button once to mute the sound. The indication **MUTE** will appear on the LCD screen. Press the **MUTE** button again to restore the sound.

### Volume Function

During disc playback, press the **VOLUME (+/-)** button on the unit or the **VOLUME UP/DOWN** button on the remote control to adjust the sound level.

### Zoom Function

This player can magnify a picture. Press the **ZOOM** button to zoom in on the screen in the normal, slow, or still play mode. Pictures can be zoomed by **x2**, **x3**, **x4**. Use the **NAVIGATION** (**◀ / ▶ / ▲ / ▼**) buttons to select the desired part of the zoomed picture.

### Random Function

Press the **RANDOM** button to play all tracks in random order. The indication **RANDOM** will appear on the LCD screen. Once all tracks have been played randomly, the unit will enter the **STOP** mode. To cancel the random function, press the **RANDOM** button a second time. The indication **RANDOM: [OFF]** will appear on the LCD screen.

**Note:** DVDs will not support random play function.

### Skip and Search Functions

1. **SKIP REVERSE** (**⏮**) and **SKIP FORWARD** (**⏭**) buttons: Use these buttons to go to the previous or next chapter on a DVD (or track on a CD).
2. **SEARCH REVERSE** (**⏪**) and **SEARCH FORWARD** (**⏩**) buttons: These buttons allow searching chapters or tracks forward or backward with a speed of up to 16 times faster than normal. Each press of the search buttons will change the speed as follows: **x2** ⇌ **x4** ⇌ **x8** ⇌ **x16**. Press the **PLAY** (**▶**) button to resume normal playback.

### Title / Chapter Search Function

Use this feature to go directly to a specific title and/or chapter.

1. While in the **PLAY** mode, press the **SEARCH** button.
2. Press the **NAVIGATION** (**◀ / ▶**) buttons to select **TITLE**.
3. Use the **NUMERIC** buttons to enter the desired number.
4. Press the **NAVIGATION** (**◀ / ▶**) buttons to select **CHAPTER**.
5. Use the **NUMERIC** buttons to input the desired chapter number.
6. Press the **ENTER** button to play.

## OPERATIONAL FEATURES

### Title / Time Search Function

Use this feature to go directly to a specific title and/or time.

1. While in the **PLAY** mode, press the **SEARCH** button.
2. Press the **NAVIGATION** (◀ / ▶) buttons to select **TITLE**.
3. Use the **NUMERIC** buttons to enter the desired number.
4. Press the **NAVIGATION** (◀ / ▶) buttons to select **TIME**.
5. Use the **NUMERIC** buttons to select the desired time.
6. Press the **ENTER** button to play.

**Note:** If the search function is attempted during playback, you can only go to a specific chapter or time. You cannot change the title number. If a time exceeding the time limit of the DVD is entered, the indication, **INVALID KEY** will appear on the LCD screen. When playing a VCD, the numeric buttons can only be used to select the desired track or time in the search mode.

### Programmed Playback

This unit has programmable memory allowing 16 tracks (or chapters) on any disc to be programmed for playback in any desired order. Certain tracks (or chapters) can also be programmed to play more than once (This feature is not available on MP3 CDs). To perform programmed playback:

1. Press the **PROGRAM** button. The program window will appear on the screen.
2. Press the **NUMERIC** buttons and enter two numbers for each track: one for title; another for chapter. Upon entering two numbers, use the **NAVIGATION** (▼) button to move to the next program track (or chapter).
3. Repeat step 2 until all titles and chapters have been programmed (up to 16). A title or chapter can be repeated more than once if desired.
4. Use the **NAVIGATION** (◀ / ▶ / ▲ / ▼) buttons to select the **PLAY** option, and then press the **ENTER** button to begin the programmed play.
5. To cancel the program function, press the **STOP** (■) button twice.

### Repeat Function

1. DVD
  - a. While in the **PLAY** mode, press the **REPEAT** button twice and the indication **REP:[CHAPTER]** will appear briefly on the LCD screen. The current chapter will now play repeatedly.
  - b. While in the **PLAY** mode, press the **REPEAT** button again and the indication **REP:[TITLE]** will appear briefly on the LCD screen. The current title will now play repeatedly.
  - c. Press the **REPEAT** button again and the indication **REP:[REP ALL]** will appear briefly on the LCD screen and the entire disc will repeat continuously until the **STOP** button is pressed.
  - d. Press the **REPEAT** button once more to cancel the **REPEAT** function.

## OPERATIONAL FEATURES

### Repeat Function-continued

2. Audio CD / VCD
  - a. To repeat a track, select the track as described in the Skip and Search section and press the **REPEAT** button twice. The indication **REP:[REP 1]** will appear on the LCD screen. The selected track will play repeatedly until the **STOP** button is pressed.
  - b. To repeat all tracks on an Audio CD or VCD, press the **REPEAT** button again. The indication **REP:[REP ALL]** will appear on the LCD screen. All tracks will now play repeatedly until the **STOP** button is pressed.
  - c. To cancel repeat play, press the **REPEAT** button until the indication **REP:[OFF]** appears on the LCD screen.

### A-B Repeat Function

This player can play a specific section of a track or chapter repeatedly.

1. While in the **PLAY** mode, press the **A-B** button to choose the starting point of the desired section.
2. Press the **A-B** button again to choose the end of the desired section. The player will now play the selected section continuously.
3. To cancel the **A-B REPEAT** mode, press the **A-B** button again until the indication disappears from the screen.

### Multi-Angle Viewing

Some DVDs contain scenes which have been filmed from several camera angles. This function depends on the particular DVD. When playing a DVD with multiple angle scenes available:

1. Press the **ANGLE** button. If a different angle is available, the camera icon  will appear on the screen.
2. Press the **ANGLE** button again to see the scene from a different camera angle. Each press of the **ANGLE** button will display a different angle.



## SETUP INSTRUCTIONS

### System Setup

1. Press the **SETUP** button in the Stop mode.
2. Use the **NAVIGATION** (▲ / ▼) buttons to select the option (TV SYSTEM, SCREEN SAVER, TV TYPE, DEFAULT) and press the **ENTER** button.
3. Use the **NAVIGATION** (▲ / ▼) buttons to adjust and press the **ENTER** button. The screen will change to your suggested setting.
4. Repeat steps 2 and 3 above to choose another option.
5. To reset all the settings to factory default settings, select the option “**DEFAULT**”.
6. To exit the **SETUP MENU** and return to a normal screen, select **EXIT SETUP** and confirm or press the **SETUP** button again.

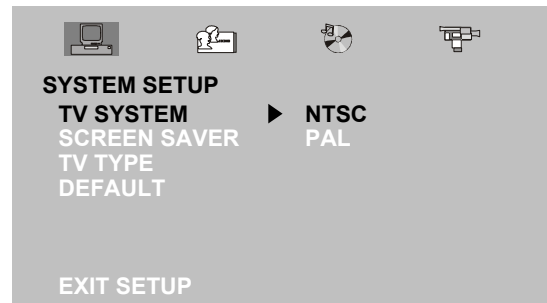

### Helpful Tips on Choosing the Aspect Ratio

1. About 4:3 PS
  - a. When wide-screen video is played, this mode crops the right and left sides off the image in order that it can be viewed on a conventional screen.
  - b. Some wide-screen DVDs do not permit Pan Scan and playback is automatically in letterbox mode (black bands on top and bottom).
2. About 4:3 LB
  - a. When wide-screen video is played in this mode on a conventional screen, black bands appear at the top and bottom of the screen.
3. About 16:9
  - a. This is the correct mode for playing wide-screen videos on a wide screen.
4. The visible picture size is preset on the DVD. Therefore the playback picture of some DVDs may not conform to the picture size you select.
5. When DVDs recorded in the 4:3 aspect ratio are played, the picture will always appear in 4:3 regardless of the TV shape setting.

### Language Setup

1. Press the **SETUP** button in the Stop mode.
2. Use the **NAVIGATION** (►) button to select **LANGUAGE SETUP**. Use the **NAVIGATION** (▲ / ▼) buttons to select a language and press the **ENTER** button.

**Note:** OSD default setting for various regions:

USA, United Kingdom, Applicable Asian

countries (English), Germany (German), Spain (Spanish), France (French), Italy (Italian).

3. Use the **NAVIGATION** (▲ / ▼) buttons to adjust and press the **ENTER** button. The screen will change to your selected language immediately.
4. To exit the **SETUP MENU** and return to a normal screen, select **EXIT SETUP** and confirm or press the **SETUP** button again.

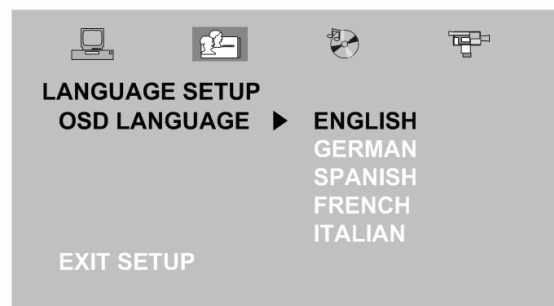

## SETUP INSTRUCTIONS

### Video Setup

1. Press the **SETUP** button in the Stop mode.
2. Use the **NAVIGATION** (▶) button to select **VIDEO SETUP**. Use the **NAVIGATION** (▲ / ▼) button to select the option (BRI, CONTRAST, HUE, SATURATION, SHARPNESS) and press the **ENTER** button.
3. Use the **NAVIGATION** (▲ / ▼) buttons to adjust and press the **ENTER** button. The screen will change to your selected setting.
4. Repeat steps 2 and 3 above to choose another option.
5. To exit the **SETUP MENU** and return to a normal screen, select **EXIT SETUP** and confirm or press the **SETUP** button again.

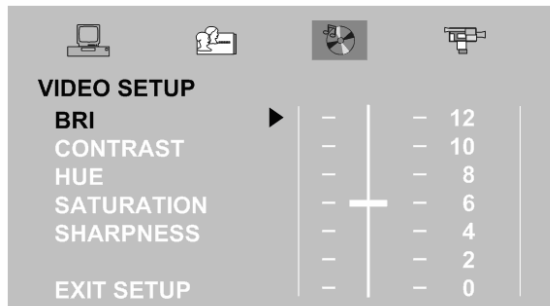

### Speaker Setup

1. Press the **SETUP** button in the stop mode.
2. Use the **NAVIGATION** (▶) button to select **SPEAKER SETUP**. Use the **NAVIGATION** (▲ / ▼) button to select **DOWNMIX**.
3. Use the **NAVIGATION** (▲ / ▼) buttons to select either MONO (**LT/RT**) or **STEREO**.
4. To exit the **SETUP MENU** and return to a normal screen, select **EXIT SETUP** and confirm or press the **SETUP** button again.

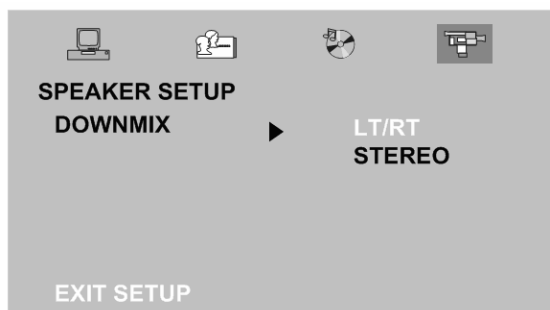

### LCD Setting

1. Press the **LCD SET** button of remote control to select Brightness, Color, Contrast and TV Type.
2. Press the **VOLUME +/-** buttons of remote control to change the settings of brightness, color, and contrast.
3. For TV TYPE, press the **VOLUME -** button to select 4:3, press the **VOLUME +** button to select 16:9.
4. Press and hold **LCD SET** button for 3 seconds to turn off or turn on the LCD display.

## CARE AND MAINTENANCE GUIDE

### Compact Disc Care

- Treat the disc carefully. Handle it only by its edges, never allowing your fingers to come in contact with the shiny, unprinted side of the disc.
- Do not attach adhesive tape, stickers, etc. to the disc label.
- Clean disc periodically with soft, lint-free, dry cloth. Never use detergents or adhesive cleaners to clean a disc. If necessary, use a CD cleaning kit.
- If disc skips or gets stuck on a certain section in playback, it may be dirty or damaged (scratched).
- When cleaning a disc, wipe in straight lines from the center of the disc to the edge. Never wipe in circular patterns.
- To remove a disc from its case, press down on the center of the case, lifting the disc out and holding it carefully by the edges.
- Fingerprints and dust should be carefully wiped from the disc's recorded surface with a soft cloth. Unlike conventional records, CDs have no grooves to collect dust and microscopic debris. Gently wiping with a soft cloth should remove most particles.



### Cleaning the Unit

- To prevent fire or shock hazard, disconnect the unit from the AC power source when cleaning.
- The finish on the unit may be cleaned with a dust cloth and cared for much like other furniture. Use caution, however, when cleaning and wiping plastic parts.
- If the cabinets become dusty, wipe with a soft dry dust cloth. Do not use wax or polish sprays on the cabinets.
- If the front panel becomes dirty or smudged with fingerprints, it may be cleaned with a soft cloth, slightly dampened with a mild soap and water solution. Never use abrasive cloths or polishes as these will damage the finish of the unit.

**Caution:** Never allow water or other liquids to get inside the unit while cleaning.

## TROUBLESHOOTING GUIDE

### No Power

- Insert the AC power plug securely into the wall power outlet

### iPod videos not displayed on the 8.4" LCD screen.

- Check the TV settings of your iPod. The **TV OUT** option of your iPod must be set to **ON**. Refer to the section **Watching Your iPod Videos on the 8.4" LCD Screen** in this manual for related instructions.
- Your iPod is not in the play mode. Play the video on your iPod.

### iPod isn't recharged.

- Check whether the AC adapter is connected. In order to charge your iPod, the AC adapter must be connected to the DVD player.
- Check whether your iPod is properly installed in the dock.

### Play does not begin even after the PLAY (▶) button is pressed or it starts to play and stops immediately

- Condensation may have formed. Allow 1 to 2 hours for the player to dry out.
- The disc may be incompatible with this unit. This player can only play DVD, VCD and CD formats.
- The disc may be dirty and require cleaning.
- The disc may be improperly loaded. Be certain it has been loaded with the label side up.

### No picture on the LCD screen

- Ensure that the disc or iPod mode is properly set.
- Ensure that the iPod is properly connected.

### No sound or distorted sound

- Ensure that the disc or iPod mode is properly set.
- Ensure that the iPod is properly connected.
- Ensure that the input settings for the iPod are properly set.

### Picture is distorted during the rapid advance or rapid reverse

- The picture will be somewhat distorted at times. This is normal.

### No rapid advance (or rapid reverse) playback

- Some discs may have sections which prohibit the rapid advance (or rapid reverse).

### Remote Control Does Not Work

- Ensure that the batteries are installed with the correct polarities (+ and -).
- The batteries may be exhausted. Replace them with new ones.
- Point the remote control unit at the remote control sensor and attempt operation.
- Operate the remote control at a distance of less than 6m from the remote control sensor.
- Remove the obstacles between the remote control unit and remote control sensor.

## TROUBLESHOOTING GUIDE

### **No 4:3 (16:9) picture display**

- Choose the correct **TV TYPE** option in the video setup page.
- If you watch 4:3 format content, you need to set the LCD display to 4:3 correspondingly (see page 25 “LCD setting” section.)

### **No key operation (with the main unit and/or the remote control unit) works**

- Press the **POWER** button on the remote control to set the player to the standby mode and then switch back on.
- Slide the power switch to the **OFF** position, then set back to **ON** position.
- Key lock function is activated, press the **KEY LOCK** button of remote control, or press and hold the **KEY LOCK** button of the unit for 3 seconds to release the key lock function.

### **No PBC play**

- This function works only for Video CDs with playback control.

### **Audio and/or subtitle language are not shown on the disc or not in the setup menu.**

- If the audio and/or subtitle language does not exist on the language selected in the setup menu, it will not be seen or heard.

### **No subtitles**

- Subtitles are not available on all discs.
- Subtitles are cleared from the TV monitor. Perform the steps in the subtitle setup instruction to display the subtitles.

### **Alternative audio (or subtitle) language fails to be selected.**

- An alternative language will not be selected with discs featuring only one language.

### **The movie angle cannot be changed.**

- This function is contingent on software availability. Even if a disc has a number of angles recorded, these angles may be recorded for specific scenes only.

## SPECIFICATIONS

- Power Requirements
  - Main Unit: DC IN 10V – 16V, Max 2A (Center Positive)
  - Built-in Rechargeable Battery: DC 7.4V, 3000mAh
  - AC Adapter (Center Positive)
    - Input: AC 100V – 240V, 60Hz/50Hz
    - Output: DC 12V, 2A
  - Car Adapter (Center Positive)
    - Input: DC 12V
    - Output: DC 12V, 2A
    - Fuse: 3A
  - Remote control Battery: 3V (CR2025, ECR2025 or DL2025)
- Power Consumption: 25W max.
- Signal System: NTSC / PAL
- Operating Temperature Range: 5°C to 35°C (41°F to 95°F)
- Operating Humidity Range: 5% to 90% (no condensation)
- Battery Charging Time: Approximately 2.5 - 3 hours
- Battery Life (Fully charged): 3 hours
- Types of Discs Played
  - DVD-VIDEO Disc
    - 12 cm single-sided, single layer
    - 12 cm single-sided, dual layer
    - 12 cm double-sided, single layer
    - 8 cm single-sided, single layer
    - 8 cm single-sided, dual layer
  - Compact Disc
    - 12 cm disc
    - 8 cm disc
- Video Output Level: 1Vpp
- Audio Output Level: 1Vrms (1 kHz, 0dB)
- Frequency Responses
  - DVD (Linear Audio)
    - 20Hz-20kHz (48kHz Sampling)
    - 20Hz-20kHz (96kHz Sampling)
  - CD Audio
    - 20Hz-20kHz
- S/N Ratio: 70dB
- Wow and flutter: below measurable level
- Pickup
  - Wave length: 655 nm
  - Laser power: CLASS 1

\* Specifications are subject to change without prior notice.



**iLuv™**

**Visit our website at [www.i-Luv.com](http://www.i-Luv.com)**

iLuv is a trademark of jWIN Electronics Corp., and all rights for use of this trademark are reserved and protected by law. All logos and brands are the property of their respective owners. Features and specifications are subject to change without prior notification. iPod is a trademark of Apple Computer, Inc. iPod is not included with this unit.

©2007 jWIN Electronics Corp., All rights reserved. No portion of this printed material or product enclosed herewith including design, shape, and graphics may be reproduced or transmitted in any form without the expressed written consent of jWIN Electronics Corp., by any means electronic or mechanical including photocopying, recording, or use of an information storage retrieval system. Any unauthorized distribution or reproduction of this printed material, or any portion thereof, will be prosecuted to the fullest possible extent of the law.

Printed in China