

JET
Power Chairs

JET
Power Chairs

JET
Power Chairs

JET
Power Chairs

JET
Power Chairs

JET
Power Chairs

JET
Power Chairs

JET
Power Chairs

JET
Power Chairs

JET 10

Owner's Manual

ATTENTION:
Please read the content
of your owner's manual
before operating your
power chair.



Stylish Design and Premium Performance[®]

Pride
Mobility Products Corp.

Exeter, PA
St. Catharines, ON

1-800-800-8586

www.pridemobility.com

SAFETY GUIDELINES

Please read and follow all instructions in this owner's manual before attempting to operate your power chair for the first time. If there is anything in this manual you do not understand, or if you require additional assistance for set-up, contact your authorized Pride provider.

Using your Pride product safely depends upon your diligence in following the warnings, cautions, and instructions in this owner's manual. Using your Pride product safely also depends upon your own good judgement and/or common sense, as well as that of your provider, caregiver, and/or healthcare professional. Pride is not responsible for injuries and/or damage resulting from any person's failure to follow the warnings, cautions, and instructions in this owner's manual. Pride is not responsible for injuries and/or damage resulting from any person's failure to exercise good judgement and/or common sense.

The symbols below are used throughout this owner's manual to identify warnings and cautions. It is very important for you to read and understand them completely.



WARNING! Failure to heed the warnings in this owner's manual may result in personal injury.



CAUTION! Failure to heed the cautions in this owner's manual may result in damage to your power chair.

CONTENTS

I. INTRODUCTION	4
II. SAFETY	6
III. EMI/RFI	14
IV. YOUR JET 10	16
V. ASSEMBLY	20
VI. COMFORT ADJUSTMENTS	22
VII. DISASSEMBLY	26
VIII. OPERATION	27
IX. BATTERIES AND CHARGING	29
X. CARE AND MAINTENANCE	34
XI. OPTIONS AND ACCESSORIES	40
XII. WARRANTY	41

I. INTRODUCTION

INTRODUCTION

Welcome to Pride Mobility Products Corporation (Pride). Congratulations on the purchase of your new Pride Power Chair. The Pride Power Chair design combines the most advanced state-of-the-art components with modern, attractive styling. We are certain that the design features and trouble-free operation of your new power chair will add convenience to your daily living.

At Pride, your safety is important to us. Please read and follow all of the instructions in this manual before you attempt to operate your power chair for the first time. These instructions were produced for your benefit. Your understanding of these instructions is essential for the safe operation of your new power chair.

Pride is not liable for damage to property or personal injury arising out of unsafe use of a power chair. Pride is also not liable for any property damage or personal injury arising out of the failure of any person and/or user to following the instructions and recommendations set forth in this manual or any other instructions or recommendations contained in other power chair related literature issued by Pride or contained on the power chair itself.

This owner's manual is compiled from the latest specifications and product information available at the time of publication. We reserve the right to make changes as they become necessary. Any changes to our products may cause slight variations between the illustrations and explanations in this manual and the product you have purchased.

If you experience any problems with your power chair that you are unable to solve, or if you do not feel capable of safely following any of the instructions and/or recommendations as contained in this manual, please contact your authorized Pride provider for assistance.

Once you understand how to operate and take care of your power chair, we are certain that it will give you years of trouble-free service and enjoyment.

Information Exchange

We want to hear your questions, comments, and suggestions about this manual. We would also like to hear about the safety and reliability of your new power chair, and about the service you received from your authorized Pride provider.

Please notify us of any change of address, so we can keep you apprised of important information about safety, new products, and new options that can increase your ability to use and enjoy your power chair. Please feel free to contact us at the address below:

Pride Mobility Products Corporation
Attn: Customer Care Department
182 Susquehanna Avenue
Exeter, PA 18643-2694
customer care@pridemobility.com
800-424-8205

I . I N T R O D U C T I O N

Pride Owners Club

As an owner of a Pride product, you are invited to register your product's warranty and enroll in the Pride Owners Club. You may do so by filling out and returning your enclosed registration card or by visiting Pride's web site at www.pridemobility.com. As a registered member, each time you visit our site, you will have access to the most interactive and honest educational venue available today for people with mobility needs, their families, and friends.

From our home page, select "Owners Club" to enter a page dedicated to current and potential Pride product owners. You will gain access to interviews, stories, recreation ideas, daily living tips, product and funding information, and interactive message boards. These message boards invited you to communicate with other Pride customers as well as Pride representatives who are available to assist you with any questions or concerns you may have.

My Authorized Pride Provider Is:

Name: _____

Address: _____

Phone Number: _____

Purchase Date: _____

NOTE: If you ever lose or misplace your product registration card or your copy of this manual, contact us and we will be glad to send you a new one immediately.

II. SAFETY

SAFETY



WARNING! Do not operate your new power chair for the first time without completely reading and understanding this owner's manual.

Your power chair is a state-of-the-art life-enhancement device designed to increase mobility. Pride provides an extensive variety of products to best fit the individual needs of the power chair user. Please be aware that the final selection and purchasing decision regarding the type of power chair to be used is the responsibility of the power chair user, who is capable of making such a decision, and his/her healthcare professional (i.e., medical doctor, physical therapist, etc.).

The contents of this manual are based on the expectation that a mobility device expert has properly fitted the power chair to the user and has assisted the prescribing healthcare professional and/or the authorized Pride provider in the instruction process for the use of the product.

There are certain situations, including some medical conditions, where the power chair user will need to practice operating the power chair in the presence of a trained attendant. A trained attendant can be defined as a family member or care professional specially trained in assisting a power chair user in various daily living activities.

As you begin using your power chair during daily activities, you will probably encounter situations in which you will need some practice. Simply take your time and you will soon be in full and confident control as you maneuver through doorways, on and off of elevators, up and down ramps, and over moderate terrain.

Below are some precautions, tips, and other safety considerations that will help the user become accustomed to operating the power chair safely.

Modifications

Pride has designed and engineered your power chair to provide maximum mobility and utility. A wide range of accessories is available from your authorized Pride provider to further customize your power chair to better suit your needs and/or preferences. However, under no circumstances should you modify, add, remove, or disable any feature, part, or function of your power chair.



WARNING! Do not modify your power chair in any way not authorized by Pride. Unauthorized modifications may result in personal injury and/or damage to your power chair.

Pre-Ride Safety Check

Get to know the feel of your power chair and its capabilities. Pride recommends that you perform a safety check before each use to make sure your power chair operates smoothly and safely. See X. "Care and Maintenance."

Perform the following inspections prior to using your power chair:

- Check for proper tire inflation. Maintain **30-35 psi** in each tire (if equipped with pneumatic tires).
- Check all electrical connections. Make sure they are tight and not corroded.
- Check all controller connections to the electronics tray. Make sure they are secured properly.

II. SAFETY

- Check the brakes. See X. “Care and Maintenance.”
- Check battery charge. See IX. “Batteries and Charging.”

NOTE: If you discover a problem, contact your authorized Pride provider for assistance.

Weight Limitations

Your power chair is rated for a maximum weight capacity. Please refer to the specifications table for this limit.



WARNING! Exceeding the weight capacity voids your warranty and may result in personal injury and/or damage to your power chair. Pride will not be held responsible for injuries and/or property damage resulting from failure to observe weight limitations.

WARNING! Do not carry passengers on your power chair. Carrying passengers on your power chair may result in personal injury and/or property damage.

Tire Inflation

If your power chair is equipped with pneumatic tires, you should check or have the air pressure checked at least once a week. Proper inflation pressures will prolong the life of your tires and help ensure the smooth operation of your power chair.



WARNING! It is important that 30-35 psi tire pressure be maintained in pneumatic tires at all times. Do not underinflate or overinflate your tires. Low pressure may result in loss of control, and overinflated tires may burst. Failure to maintain 30-35 psi tire pressure in pneumatic tires at all times may result in tire and/or wheel failure, causing serious personal injury and/or damage to your power chair.

WARNING! Inflate your power chair drive tires from a regulated air source with an available pressure gauge. Inflating your tires from an unregulated air source could overinflate them, resulting in a burst tire and/or personal injury.

Incline Information

More and more buildings have ramps with specified degrees of inclination, designed for easy and safe access. Some ramps may have turning switchbacks (180-degree turns) that require you to have good cornering skills on your power chair.

- Proceed with extreme caution as you approach the downgrade of a ramp or other incline.
- Take wide swings with your power chair’s front wheels around any tight corners. If you do that, the power chair’s rear wheels will follow a wide arc, not cut the corner short, and not bump into or get hung up on any railing corners.
- When driving down a ramp, keep the power chair’s speed adjustment set to the slowest speed setting to ensure a safely controlled descent. See VIII. “Operation.”
- Avoid sudden stops and starts.

When climbing an incline, try to keep your power chair moving. If you must stop, start up again slowly and then accelerate cautiously. When driving down an incline, set your power chair to the slowest setting and drive in the forward direction only. If your power chair starts to move down the incline faster than you anticipated or desired, allow it to come to a complete stop by releasing the joystick, then push the joystick forward slightly to ensure a safely controlled descent.

II. SAFETY

WARNING! When climbing an incline, do not zigzag or drive at an angle up the face of the incline. Drive your power chair straight up the incline. This greatly reduces the possibility of a tip or a fall. Always exercise extreme caution when negotiating an incline.

WARNING! You should not travel up or down a potentially hazardous incline (i.e., areas covered with snow, ice, cut grass, or wet leaves).



WARNING! When on any sort of an incline or decline, never place the power chair in freewheel mode while seated on it or standing next to it. Doing so may result in personal injury and/or damage to your power chair.

WARNING! Never travel down an incline backwards. This may result in personal injury.

WARNING! Even though your power chair is capable of climbing slopes greater than those illustrated in figures 1 and 2, do not, under any circumstances, exceed the incline guidelines or any other specifications presented in this manual. Doing so could cause instability in your power chair, resulting in personal injury and/or damage to your power chair.

In compliance with the Americans with Disabilities Act of 1990, all handicap public access ramps are required to have a maximum slope of 5°. Therefore, Pride recommends that the maximum slope of an incline you attempt to safely ascend or descend on your power chair does not exceed 5°. See figure 1.

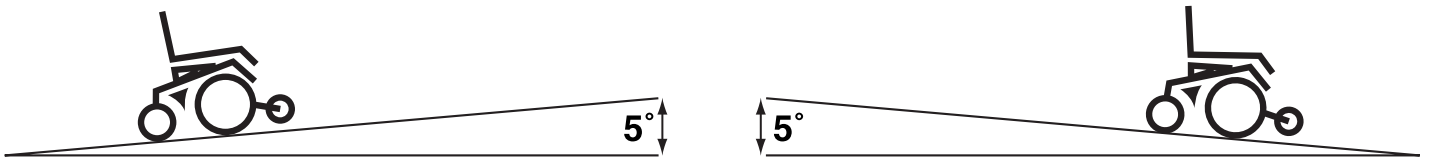

Figure 1. Maximum Safe Angle (Ascending and Descending)



WARNING! Any attempt to climb or descend a slope steeper than 5° may put your power chair in an unstable position and cause it to flip, resulting in personal injury.

Braking Information

Your power chair is equipped with two powerful brake systems:

1. Regenerative — uses electricity to rapidly slow the vehicle when the joystick returns to the center/stop position.
2. Disc Park Brake — activates mechanically after regenerative braking slows the vehicle to near stop, or when power is removed from the system for any reason.

Cornering Information

While your power chair is equipped with rear caster wheels in back and anti-tip wheels in front, excessively high cornering speeds can still create the possibility of tipping. Factors which affect the possibility of tipping include, but are not limited to: cornering speed, steering angle (how sharply you are turning), uneven road surfaces, inclined road surfaces, riding from an area of low traction to an area of high traction (such as passing from a grassy area to a paved area — especially at high speed while turning), and abrupt directional changes. High cornering speeds are not recommended. If you feel that you may tip over in a corner, reduce your speed and steering angle (i.e., lessen the sharpness of the turn) to prevent your power chair from tipping.

II. SAFETY



WARNING! When cornering sharply, reduce your speed. This greatly reduces the possibility of a tip or fall. To avoid personal injury and/or property damage, always exercise common sense when cornering.

Outdoor Driving Surfaces

Your power chair is designed to provide optimum stability under normal driving conditions—dry, level surfaces composed of concrete, blacktop, or asphalt. However, Pride recognizes that there will be times when you will encounter other surface types. For this reason, your power chair is designed to perform admirably on packed soil, grass, and gravel. Feel free to use your power chair safely on lawns and in park areas.

- Reduce your power chair's speed when driving on uneven terrain and/or soft surfaces.
- Avoid tall grass that can entangle the running gear.
- Avoid loosely packed gravel and sand.
- If you feel unsure about a driving surface, avoid that surface.

Freewheel Mode

Your power chair is equipped with a manual freewheel lever to allow for manual maneuverability by a trained attendant. For more information about how to place your power chair into and out of freewheel mode, see IV. "Your Jet 10."



WARNING! Do not use your power chair in freewheel mode without an attendant present. Personal injury may result.

WARNING! Do not attempt to personally place your power chair in freewheel mode while seated on it. Personal injury may result. Ask an attendant for assistance if necessary.

WARNING! Do not place your power chair in freewheel mode while on an incline. The chair could roll uncontrollably on its own, causing personal injury.

Stationary Obstacles (Steps, Curbs, etc.)

Proceed with extreme caution when driving near raised surfaces, unprotected ledges and/or drop-offs (curbs, porches, stairs, etc.). The correct method for approaching a curb is illustrated in figure 2.



WARNING! Do not attempt to have your power chair climb or descend an obstacle that is higher than two inches unless you have the assistance of an attendant.

WARNING! Do not attempt to have your power chair proceed backward down any step, curb, or other obstacle. This may cause the power chair to tip and cause personal injury.

Public Streets and Roadways



WARNING! You should not operate your power chair on public streets and roadways. Be aware that it may be difficult for traffic to see you when you are seated on your power chair. Obey all local pedestrian traffic rules. Wait until your path is clear of traffic, and then proceed with extreme caution.

II. SAFETY

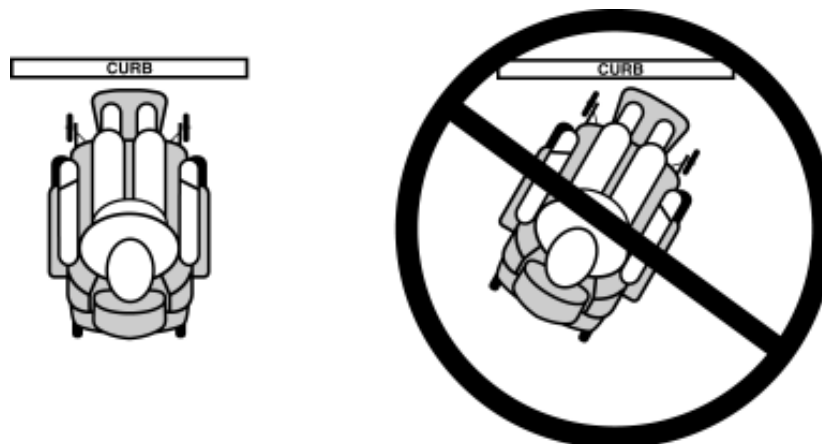

Figure 2. Curb Approach (Correct and Incorrect)

Stairs and Escalators

Power chairs are not designed to travel up or down stairs or escalators. Always use an elevator.



WARNING! Never use your power chair to negotiate steps or escalators. You may cause injury to yourself and to others and/or damage your power chair.

Doors

- Determine if the door opens toward or away from you.
- Drive your power chair gently and slowly forward to push the door open. Or drive your power chair gently and slowly backward to pull the door open.

Elevators

Modern elevators have a door edge safety mechanism that, when pushed, reopens the elevator door(s).

- If you are in the doorway of an elevator when the door(s) begin to close, push on the rubber door edge or allow the rubber door edge to contact the power chair and the door will reopen.
- Use care that pocketbooks, packages, or power chair accessories do not become caught in elevator doors.

EMI & RFI

Laboratory tests performed by the Food and Drug Administration (FDA) have shown that radio waves can cause unintended motion of electric mobility vehicles. Radio waves are a form of electromagnetic energy (EM). When EM adversely affects the operation of an electronic device, it is called Electromagnetic Interference (EMI) or Radio Frequency Interference (RFI). For more information, see III. “EMI/RFI.”

Lift/Elevation Products

If you will be traveling with your power chair, you may find it necessary to use a lift/elevation product to aid in transportation. Pride recommends that you closely review the instructions, specifications, and safety information set forth by the manufacturer of the lift/elevation product before using that product.

II. SAFETY

Motor Vehicle Transport

Currently, there are no standards approved for tie-down systems in a moving vehicle of any type to transport a person while seated in a power chair.

Transfers

Transferring onto and off of your power chair requires a good sense of balance. Always have an attendant or healthcare professional present while learning to properly transfer yourself.

To eliminate the possibility of injury, Pride recommends that you or a trained attendant perform the following tasks before attempting a transfer:

- Turn the power off. See VIII. “Operation.”
- Ensure your power chair is not in freewheel mode. See IV. “Your Jet 10.”
- Turn both caster wheels toward the transfer destination to improve power chair stability during transfer.
- Make sure both armrests are flipped up or removed from your power chair.
- Flip the footrest up, or move the leg rests aside; this will help to keep your feet from getting caught on the footrest or the leg rests during the transfer.
- Reduce the distance between your power chair and the object you are transferring onto.

WARNING! Before transferring, position yourself as far back as possible in the power chair seat to prevent the power chair from tipping forward during transfer and causing injury.



WARNING! Avoid using your armrests for weight bearing purposes. Such use may cause the power chair to tip and cause personal injury.

WARNING! Avoid putting all of your weight on the footrest. Such use may cause the power chair to tip and cause personal injury.

Positioning Belts

Your authorized Pride provider, therapist(s), and other healthcare professionals are responsible for determining your requirement for a positioning belt in order to operate your power chair safely.

WARNING! If you require a positioning belt to safely operate your power chair, make sure it is fastened securely. Serious personal injury may result if you fall from the power chair.



WARNING! The positioning belt is not designed for use as a seat belt in a motor vehicle. Nor is your power chair suitable for use as a seat in any vehicle. Anyone traveling in a vehicle should be properly belted into seats approved by the vehicle manufacturer.

WARNING! Do not sit on your power chair while it is in a moving vehicle. Personal injury and/or property damage may result.

WARNING! Always be sure your power chair and its batteries are properly secured when it is being transported. Failure to do so may result in personal injury and/or damage to your power chair.

II. SAFETY

Inclement Weather Precautions



WARNING! Pride recommends that you do not operate your power chair in icy or slippery conditions or on salted surfaces (i.e., walks or roads). Such use may adversely affect the performance and safety of your power chair, resulting in an accident and personal injury.

WARNING! Do not expose your power chair to any type of moisture at any time (rain, snow, mist, or wash). Such exposure can damage your power chair. Never operate your power chair if it has been exposed to moisture until it has dried thoroughly.

Reaching and Bending

Never reach, lean, or bend while driving your power chair. If it is absolutely necessary to reach, lean, or bend while seated on your power chair, it is important to maintain a stable center of gravity and keep the power chair from tipping. Pride recommends that the power chair user determine his/her personal limitations and practice bending and reaching in the presence of a qualified healthcare professional.



WARNING! Do not bend, lean, or reach for objects if you have to pick them up from the floor by reaching down between your knees. Movements such as these may change your center of gravity and the weight distribution of the power chair. This may cause your power chair to tip, possibly resulting in personal injury. Keep your hands away from the tires when driving.

Batteries

In addition to following the warnings below, be sure to comply with all other battery handling information. For more information about your power chair's batteries, see IX. "Batteries and Charging."



WARNING! Power chair batteries are heavy. See specifications table. If you are unable to lift that much weight, be sure to get help. Lifting beyond your capacity can result in personal injury.

WARNING! Battery posts, terminals, and related accessories contain lead and lead compounds. Wash hands after handling.

WARNING! Always protect the batteries from freezing and never charge a frozen battery. Charging a frozen battery may result in personal injury and/or damage to the battery.

Preventing Unintended movement



WARNING! If you anticipate being seated in a stationary position for an extended period of time, turn off the power. This will prevent unexpected motion from inadvertent joystick contact. This will also eliminate the possibility of unintended chair movement from electromagnetic (EM) sources. Failure to do so may result in personal injury.

Prescription Drugs/Physical Limitations

Users must exercise care and common sense when operating a power chair. This includes awareness of safety issues when taking prescribed or over-the-counter drugs or when the user has specific physical limitations.

II. SAFETY



WARNING! Consult your physician if you are taking prescribed or over-the-counter medication or if you have certain physical limitations. Some medications and limitations may impair your ability to operate your power chair in a safe manner.

Alcohol

The power chair user must exercise care and common sense when operating his/her power chair. This includes awareness of safety issues while under the influence of alcohol.



WARNING! Do not operate your power chair while you are under the influence of alcohol, as this may impair your ability to operate your power chair in a safe manner.

Removable Parts



WARNING! Do not attempt to lift or move a power chair by any of its removable parts. Personal injury and/or damage to the power chair may result.

III. EMI / RFI

EMI/RFI WARNINGS

Laboratory tests performed by the Food and Drug Administration (FDA) have shown that radio waves can cause unintended motion of electric mobility vehicles. Radio waves are a form of electromagnetic energy (EM). When this energy unintentionally affects the operation of an electronic device, it is called *Electromagnetic Interference (EMI)* or *Radio Frequency Interference (RFI)*.



WARNING! Radio waves may interfere with the control of power chairs.

FREQUENTLY ASKED QUESTIONS (FAQS)

The following FAQs summarize what you should know about EMI/RFI. Use this information to minimize the risk that EMI/RFI may affect your power chair.

Where do radio waves come from?

Radio waves are emitted from the antennas of cellular phones, mobile two-way radios, walkie-talkies, radio stations, TV stations, amateur radio (HAM) transmitters, wireless computer links, microwave sources, and paging transmitters. Radio waves are a form of electromagnetic energy (EM). EM is more intense closer to transmitting antennas, which are sources of emission. The greater the transmission strength, the greater the concern to electric mobility vehicle users.

If my power chair is affected by EMI/RFI, what kind of motion should I expect?

This is hard to predict. The effect may depend on a number of factors including:

- Strength of the radio waves
- Construction of the electric mobility vehicle
- Position of the power chair (whether it is on level ground or on a slope)
- Whether or not the electric mobility vehicle is in motion

Electric mobility vehicle motion caused by EMI/RFI can be erratic. The vehicle may move by itself or come to a sudden stop. Furthermore, it is possible for EMI/RFI to unexpectedly release the brakes on an electric mobility vehicle. Some intense sources of EMI/RFI can even damage the control system of an electric mobility vehicle.

Is there any way to know for sure whether radio waves are responsible for the unintended motion of my power chair?

Unfortunately, interference from radio wave sources may be difficult to recognize, because the signals from these sources are invisible and may be intermittent. However, the FDA recommends that you report all incidents of unintended motion or brake release to the electric mobility vehicle manufacturer and, if possible, note whether there was a radio wave source nearby at the time of the incident.

Has anyone been hurt from erratic, unintended motion of electric mobility vehicles?

The FDA has reports of injuries that may have resulted from the uncontrolled motion of electric mobility vehicles. However, it is unclear how many of these incidents were actually caused by radio wave interference.

III. EMI/RFI

Are all electric mobility vehicles susceptible to EMI/RFI?

Each make and model differs in its ability to resist EMI/RFI. Each electric mobility vehicle has a particular level of immunity to EMI/RFI. This immunity is measured in volts per meter (V/m). A higher immunity level offers greater protection. In other words, a power chair with a high immunity level is less likely to be affected by a strong radio source than one with a low immunity level.

What is the FDA doing about the problem?

The FDA has written to electric mobility vehicle manufacturers and requested that they test their new products to be sure that they provide a reasonable degree of immunity against EMI/RFI. The letter states that electric mobility vehicles should have an immunity level of at least 20 V/m. This provides a reasonable degree of protection against the common sources of EMI/RFI.

The FDA has also requested or recommended that:

- Electric mobility vehicle manufacturers clearly label new products with their immunity level, or state that the immunity level is not known.
- The labeling or informational material supplied with new electric mobility vehicles must explain what the immunity level means and warn users about the possibility of EMI/RFI and how to avoid it.
- Electric mobility vehicle manufacturers undertake an educational program to inform users and their caregivers about the problems associated with EMI/RFI and about the actions they can take to minimize the risk of EMI/RFI.
- While there is no exact way to tell if your electric mobility vehicle is totally safe from EMI/RFI, an immunity level of 20 V/m is generally achievable and useful. Your Jet 10 has been tested and passed at an immunity level of 20 V/m.

What can I do to find out if my power chair is likely to be affected by EMI/RFI?

If you have owned your power chair for a long time and have not experienced unintended motion, it is unlikely that you will have problems in the future. However, it is always possible that problems could arise if your power chair is close to a source of radio waves. Therefore, it is very important to be alert to this possibility. Your power chair meets or exceeds an immunity level of at least 20 V/m.

What can I do to reduce the risk that my power chair could be affected by EMI/RFI?

Here are some precautions you can take:

- Do not turn on or use hand-held personal communications devices, such as citizens band (CB) radios and cellular phones, while the power chair is on.
- Be aware of nearby transmitters such as radio or TV stations and hand-held or mobile two-way radios, and try not to come close to them. For example, if you are in a power chair with an immunity level of 20 V/m, you should remain at least three feet from a hand-held two-way radio and ten feet from a mobile two-way radio.
- Be aware that adding accessories and/or components or modifying the power chair may make it more susceptible to interference from radio wave sources.

What should I do if my power chair moves unexpectedly?

If unintended motion or brake release occurs, turn the power chair off as soon as it is safe to do so. Call Pride at 800-424-8205 to report the incident.

IV. YOUR JET 10

Your Jet 10 has two main assemblies: the seat and the power base. See figures 3 and 4. Typically, the seating assembly includes the armrests, seatback, and a joystick/controller. Your Jet 10 seat may also have some optional accessories attached to it, such as a basket, a cane/crutch holder, or a cup holder. See XI. “Options and Accessories.”

The power base assembly is the heart of your Jet 10. The power base assembly includes two drive wheels, two anti-tip wheels, two rear caster wheels, a body shroud, and footrest.

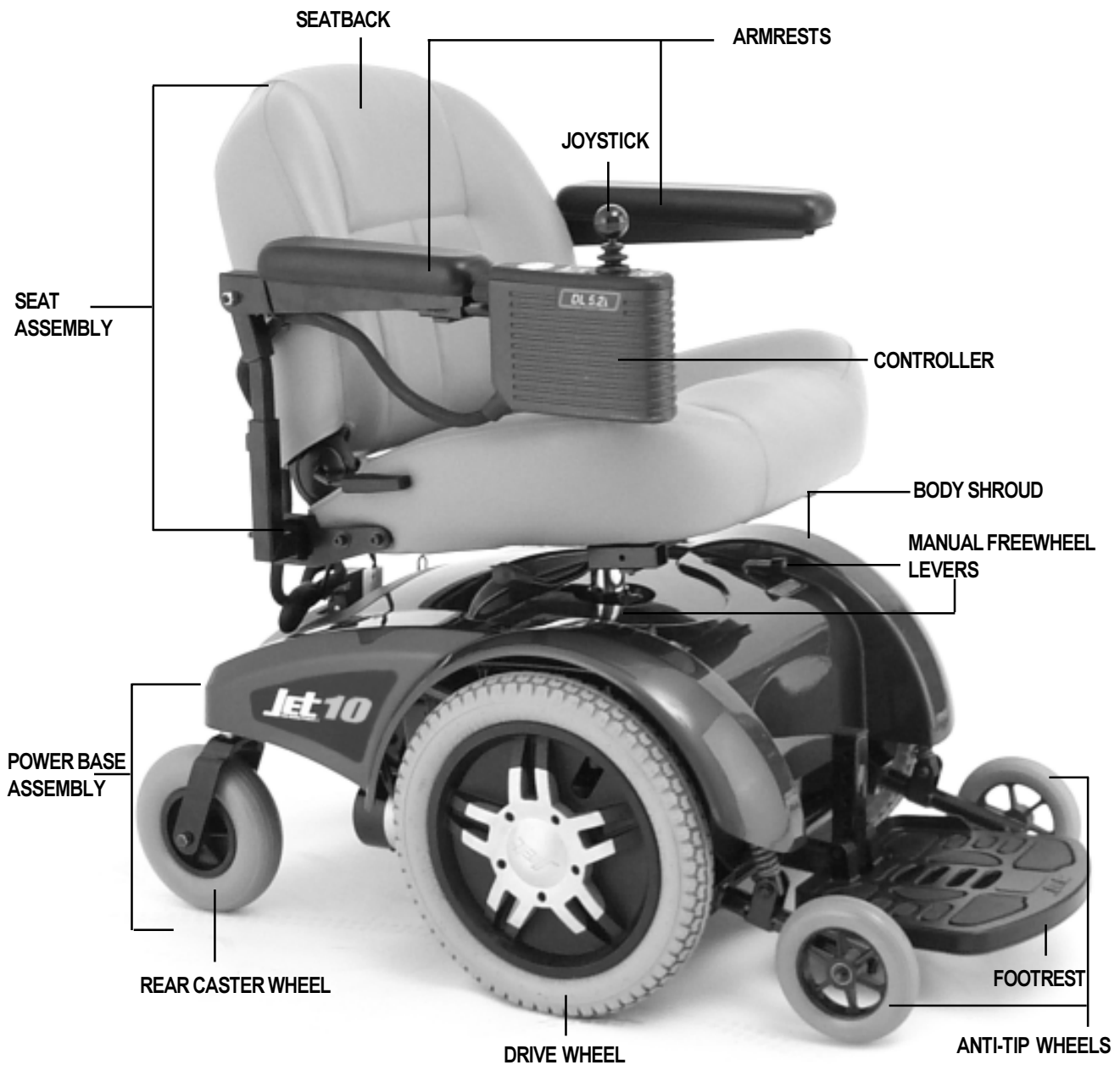

Figure 3. Your Jet 10

IV. YOUR JET 10

Specifications	
Suspension:	Limited
Drive Wheels:	14 in. solid tires
Caster Wheels:	8 in. solid, rear articulating
Anti-tip Wheels:	6 in. solid, front mounted
Max. Speed:	Up to 4.5 mph
Brakes:	“Intelligent Braking,” electronic regenerative, disc park brake
Ground Clearance:	3.0 in.
Turning Radius:	19.5 in.
Overall Size:	Length: 38 in. Width: 23 in.
Seating Options:	Medium-back (standard) High-back with headrest
Drivetrain:	Two motor, mid-wheel
Batteries:	NF-22 batteries
Range:	Up to 25 miles
Battery Charger:	4-amp onboard
	4-amp off-board
Electronics:	50-amp Dynamic DL Controller (non programmable)
Weight Capacity:	250 lbs.
Jet 10 Weights:	Base: 96 lbs. Seat: 36.5 lbs. Batteries: 38 lbs.
Warranty:	Five-year limited warranty on frame One-year warranty on electronics One-year warranty on drive motors

IV. YOUR JET 10

ELECTRICAL CONNECTORS AND COMPONENTS

The electrical connectors and components are located on the back of your Jet 10. See figure 4.

- **Battery charger AC power cord receptacle:** This is where your battery charger power cord plugs in. The battery charger power cord is not attached to the unit at all times. For more information, see IX. “Batteries and Charging.”
- **Ammeter:** The ammeter displays the charger’s current output in amps. For more information, see VIII. “Operation.”
- **9-pin Controller Connector:** This is where the joystick connects to the motors, batteries, and brakes.
- **Charger Connector:** This is where the charger connects to the controller.
- **Main Circuit Breaker:** The main circuit breaker is a safety feature built into your Jet 10. When the batteries and the motors are heavily strained (e.g., from excessive loads), the main circuit breaker will trip to prevent damage to the motors and the electronics. If the circuit trips, allow your Jet 10 to “rest” for approximately one minute. Then, push in the circuit breaker button, turn on the controller power, and continue normal operation. If the main circuit breaker continues to trip repeatedly, contact your authorized Pride provider.

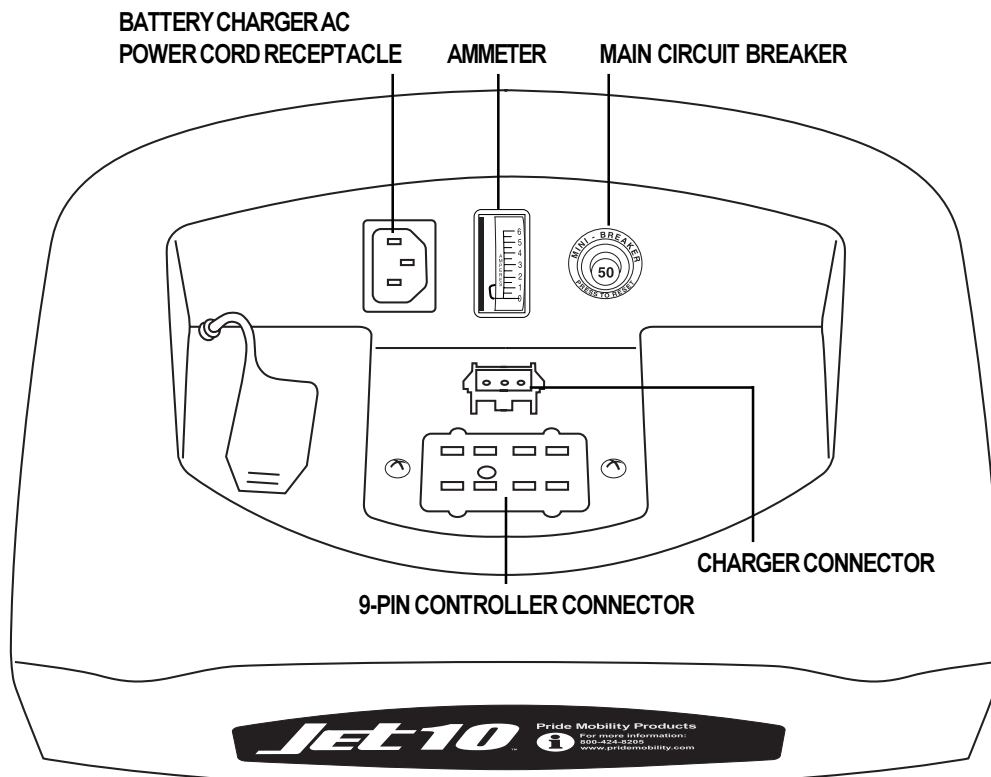

Figure 4. Utility Tray

IV. YOUR JET 10

MANUAL FREEWHEEL LEVERS

For your convenience, your Jet 10 is equipped with two manual freewheel levers. See figures 5 and 6. These levers allow you to disengage the drive motors and maneuver the chair manually.



WARNING! Do not use your power chair while the drive motors are disengaged unless you are in the presence of an attendant! Do not disengage the drive motors when your Jet 10 is on an incline. The chair could roll down on its own, causing injury.

To engage or disengage the freewheel feature:

1. Turn the manual freewheel levers inward to disengage the drive motors. See figure 5.
2. Turn the manual freewheel levers outward, to engage the drive motors. See figure 6.

If a lever is difficult to move in either direction, rock your Jet 10 back and forth slightly. The lever should then move to the desired position.



CAUTION! It is important to remember that when your Jet 10 is in freewheel mode, the braking system is disengaged.



Figure 5. Drive Disengaged



Figure 6. Drive Engaged

V. ASSEMBLY

To reduce the possibility of shipping damage, your Jet 10's seat is removed from the power base. The joystick may also have been removed from the armrest. The following is a set of instructions to help you quickly and easily prepare your Jet 10 for immediate use.

SEAT INSTALLATION



CAUTION! Do not pick up the seat frame by the armrests. They are free to pivot, and you may lose control of the seat if they do so, resulting in personal injury or damage to the chair.

To install the seat:

1. Set the seat on the seat tower. See figures 7 and 8.
2. Push the seat down until the latch engages.
3. Plug in the charger connector and the 9-pin controller connector into the power base. See figures 9 and 10. The charger connector is coded with colored dots. The dots are positioned so that the flat side of the male connector aligns with the flat side of the female connector while making the connection.



WARNING! Failure to properly align the connectors can result in damage to the controller, the charger, and the connectors.

JOYSTICK INSTALLATION

Your Jet 10 is equipped with a Dynamic DL joystick controller. It may have been shipped without the joystick installed in the armrest.

To install the joystick controller:

1. Use a 3/16-in. hex key to loosen the setscrew. See figure 11.
2. Slide the joystick mounting arm into or out of the armrest bracket to the desired position.
3. Retighten the setscrew by turning it clockwise.



CAUTION! Do not place the controller cable so that it can be pinched in the seat frame or the power base frame.



Figure 7. Seat Tower



Figure 8. Seat Installation



Figure 9. Charger Connector

V. ASSEMBLY



Figure 10. 9-pin Controller Connector



Figure 11. Joystick And Bracket

VI. COMFORT ADJUSTMENTS

After you have become familiar with your Jet 10's operation, you may find the need to adjust the seat. There are some adjustments you can make to increase your comfort such as seat height, armrest width, height and angle, footrest height and angle, and joystick position.



WARNING! If your power chair was configured at your authorized Pride provider, please consult your healthcare professional before changing the seat position or making any other adjustment. Some adjustments may degrade your Jet 10's performance and safety by changing its center of gravity.

SEAT HEIGHT

You can change the seat height manually.

To change the seat height:

1. Remove the seat. See VII. "Disassembly."
2. Use a 7/16-in. socket or wrench to remove the nut and bolt from the seat post. See figure 12.
3. Raise or lower the seat post to the desired position.
4. Install the nut and bolt into the seat post.
5. Install the seat.

ARMREST WIDTH

To change the armrest width:

1. Locate the two setscrews on the armrest receiver bracket. See figure 13.
2. Loosen the setscrews, slide the armrests in or out for the desired width.
3. Tighten the setscrews.

NUT AND BOLT



Figure 12. Seat Post Nut And Bolt

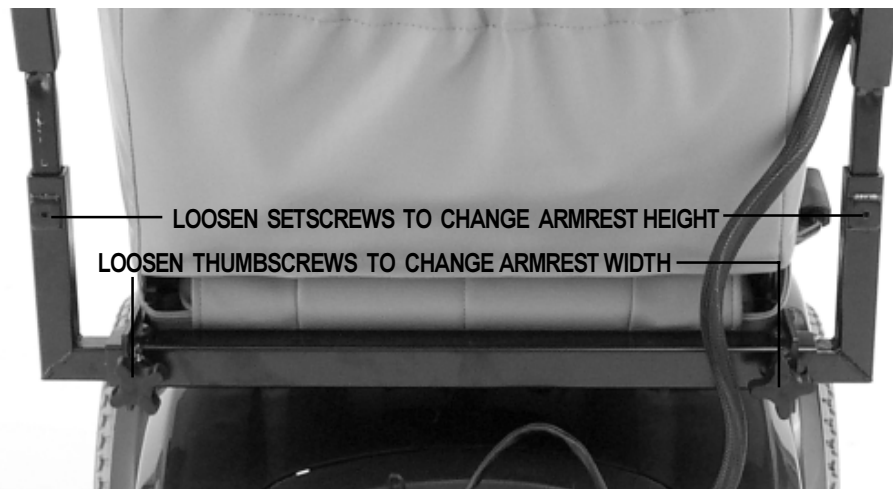

Figure 13. Armrest Width and Height

VI. COMFORT ADJUSTMENTS

ARMREST ANGLE

You can adjust the armrest angle to fit your specific needs. See figure 14.

To change the armrest angle:

1. Lift the armrest straight up so that it is perpendicular to the floor.
2. Use a 1/2-in. wrench to loosen the jam nut. See figure 14.
3. Use a 1/2-in. wrench to loosen the adjusting screw.
4. Turn the screw clockwise to lower the front of the armrest, or turn the screw counterclockwise to raise the front of the armrest.
5. Lock the adjusting screw into place by tightening the jam nut.

ARMREST HEIGHT (OPTIONAL)

Your Jet 10 may be equipped with height-adjustable armrests.

To change the armrest height:

1. Locate the two setscrews under the rear of the armrests. See figure 13.
2. Use a 5/32-in. hex key to loosen the screws, then slide the armrests in or out for the desired width.
3. Tighten the setscrews.

JOYSTICK EXTENSION

The joystick control can easily slide out away from the armrest, or in toward the armrest. See figure 15.

To extend the joystick:

1. Use a 5 mm hex key to loosen the setscrew.
2. Slide the joystick mounting bracket into or out of the armrest to the desired position.
3. Tighten the setscrew by turning the hex key clockwise.

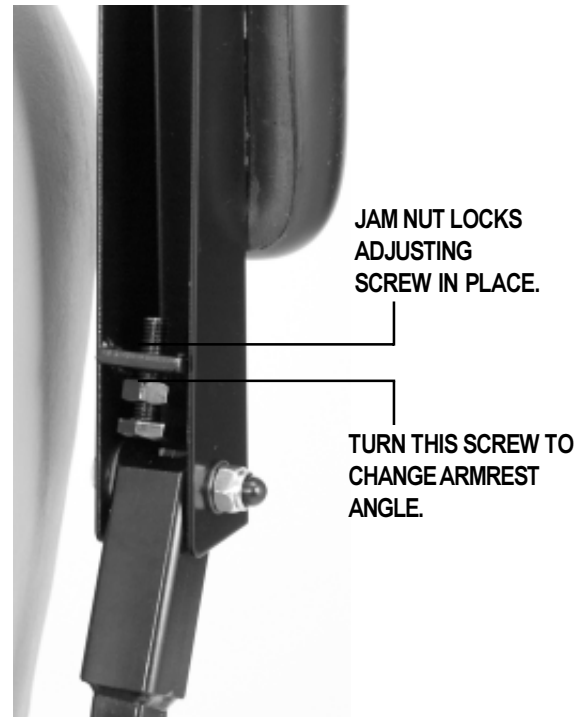

JAM NUT LOCKS
ADJUSTING
SCREW IN PLACE.

TURN THIS SCREW TO
CHANGE ARMREST
ANGLE.

Figure 14. Armrest Angle Adjustment

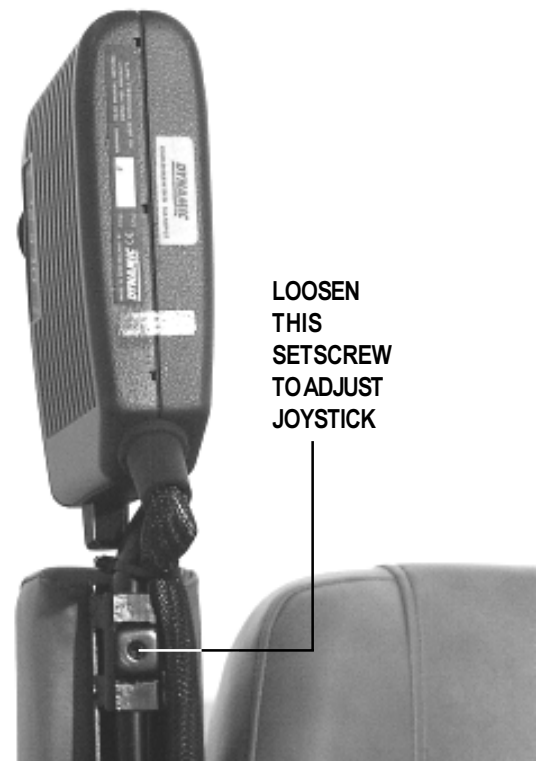

LOOSEN
THIS
SETSCREW
TO ADJUST
JOYSTICK

Figure 15. Joystick Extension

VI. COMFORT ADJUSTMENTS

FOOTREST HEIGHT

The footrest height is easily adjusted to one of six different heights in one-inch increments.

To raise or lower the footrest:

1. Use a 5/16-in. hex key and a 7/16-in. wrench to remove the nut and bolt as shown in figure 16.
2. Raise or lower the footrest to the desired height.
3. Reinstall the nut and bolt into the footrest and tighten.

FOOTREST ANGLE

You can adjust the angle of the footrest with a 7/32-in. hex key. See figure 17.

To adjust the footrest angle:

1. Loosen the jam nut.
2. Turn the setscrew clockwise to lower the front of the footrest.
3. Turn the setscrew counterclockwise to raise the front of the footrest.
4. Tighten the jam nut.

SWING-AWAY FOOTRESTS OPTION

Swing-away footrests (SFRs) are an option. They enable you to move the leg rest to the side before getting off your Jet 10.

To move the SFRs:

1. Push in the SFR release lever. See figure 18.
2. Move the SFRs aside.

ELEVATING LEG RESTS OPTION

Elevating leg rests (ELRs) offer an infinite range of adjustment for the leg angle and a footrest adjustment range of 12-19 in.

To adjust the ELR angle:

1. Press the release lever. See figure 19.
2. Move the leg rest to the desired angle.



Figure 16. Footrest Height



Figure 17. Footrest Angle

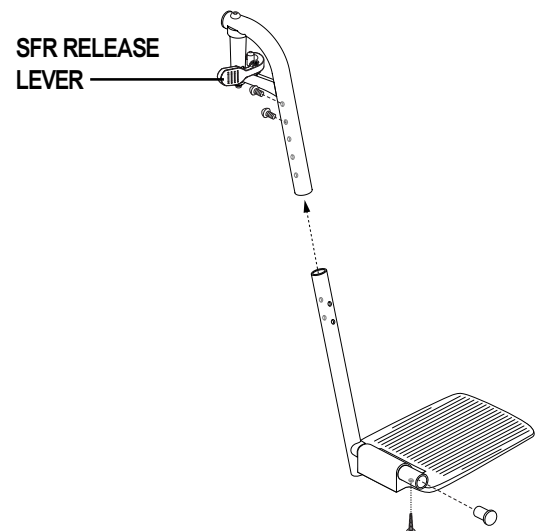

Figure 18. Swing-away Footrests

VI. COMFORT ADJUSTMENTS

To adjust the ELR length:

1. Remove the two leg rest adjustment screws from the side of each leg rest extension. See figure 20.
2. Loosen the bolt on the side of each leg rest extension.
3. Slide the leg rest in or out to the desired length.
4. Tighten the bolt and reinstall the two screws on each leg rest extension.

ANTI-TIP WHEELS

The anti-tip wheels are designed to give your Jet 10 increased stability on rough surfaces. The anti-tip wheels are preset at the factory to a height of 1/2 in. off the ground. This setting is for smooth surfaces or for indoor use only. If you plan on using your Jet 10 on rough surfaces, it may be necessary to adjust the anti-tip wheels to better suit your needs.

The anti-tip wheels may need adjustment if either of the following occur:

- When coming to a stop, your Jet 10 tips forward excessively.
- The anti-tip wheels constantly rub the ground.

WARNING! Consult your authorized Pride provider before attempting to change the anti-tip wheel height! Changing the anti-tip wheel height affects handling under deceleration!



WARNING! The higher you raise the anti-tip wheels, the more you increase your power chair's tendency to tilt forward when coming to a stop. You can compensate for this by having your authorized Pride provider make a small adjustment to the pre-programmed deceleration setting in the controller or by moving the seat assembly further to the rear of your power chair.

Required Tool: 13 mm wrench

NOTE: Each drive tire must have at least 30 lbs. of air pressure in order for the anti-tip wheels to be properly adjusted.

To adjust the anti-tip wheels:

1. Remove the seat and body shroud.
2. Adjust the 13 mm anti-tip adjustment nut so that the anti-tip wheel is 1/2 to 1 inch off the ground. Turn the nut clockwise to raise the anti-tip wheel and counter-clockwise to lower the anti-tip wheel. See figure 21.

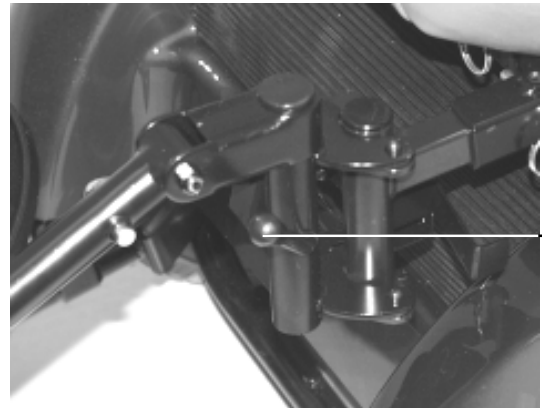

Figure 19. Elevating Leg Rests
RELEASE LEVER

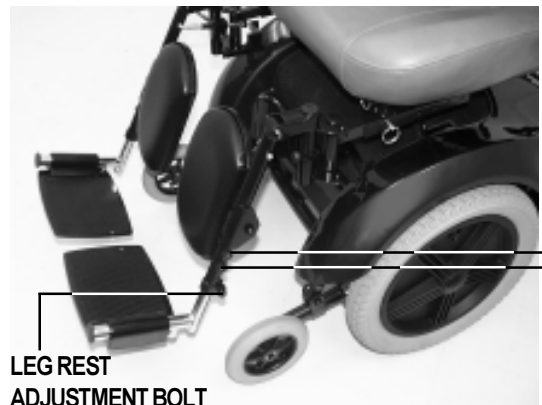

Figure 20. Elevating Leg Rests
LEG REST ADJUSTMENT BOLT
LEG REST ADJUSTMENT SCREWS



Figure 21. Anti-tip Adjustment

VII. DISASSEMBLY

SEAT REMOVAL

You may wish to remove the seat for transportation. See figure 22.

To remove the seat:

1. Turn the power off.
2. Make sure your Jet 10 is not in freewheel mode.
3. Unplug the controller harnesses behind the seat.
4. Push the lever located underneath the seat toward the front of the seat. If the joystick controller is on the right, swivel the seat clockwise and then pull the seat upward. If the joystick controller is on the left, swivel the seat counterclockwise and then pull the seat upward.



Figure 22. Removing The Seat

BODY SHROUD REMOVAL

The body shroud is a one-piece, molded plastic body that covers the power base frame. It helps protect the Jet 10 components from the environment. You must remove the body shroud in order to change the batteries and check the cable connections.

To remove the body shroud:

1. Turn the power off.
2. Make sure your Jet 10 is not in freewheel mode. See IV. “Your Jet 10.”
3. Unplug the 9-pin controller harness and the charger harness.
4. Remove the seat.
5. Remove the two screws that fasten the body shroud to the frame. Lift the body shroud straight up. The body shroud should lift up easily.



WARNING! Your power chair batteries are heavy. Refer to the specifications table for specific weights. Lifting weight above your capacity could result in injury.

BATTERY REMOVAL

To remove the batteries:

1. Turn the power off.
2. Disconnect the 9-pin controller harness and the charger harness.
3. Remove the seat
4. Lift off the body shroud.
5. Remove the battery post caps (both red and black).
6. Unscrew the wing nuts on (+) red battery terminals, one at a time.
7. Remove the (+) red battery cables from the battery posts; be sure to secure them away from the batteries.
8. Loosen the wing nuts on (-) black battery terminals.
9. Remove the (-) black cables and secure them away from the batteries.

VIII. OPERATION

DYNAMIC DL CONTROLLER

The Dynamic DL controller has a speed and response adjustment knob that combines both speed and response functions. See figure 23. When you increase the speed, you decrease the sensitivity. When you decrease the speed, you increase the sensitivity.

NOTE: We recommend that you turn the speed and response adjustment knob completely counterclockwise (to the slowest setting) the first few times you operate your Jet 10. This will allow you to become familiar with your new power chair.

To operate your Jet 10:

1. Turn it on (push the on/off button). The battery condition meter will light, indicating the present charge of your battery.
2. Push the joystick in the direction you wish to move. The further you push the joystick from the center (neutral) position, the faster your Jet 10 will move.

WARNING! If your power chair begins to move in an unexpected manner, immediately release the joystick. Unless the joystick is damaged, this action should stop your power chair.



WARNING! Unless faced with an emergency, do not use the on/off key to stop the chair. This will cause the power chair to stop abruptly.

WARNING! Always turn the power off when you are stationary to prevent unexpected movement.

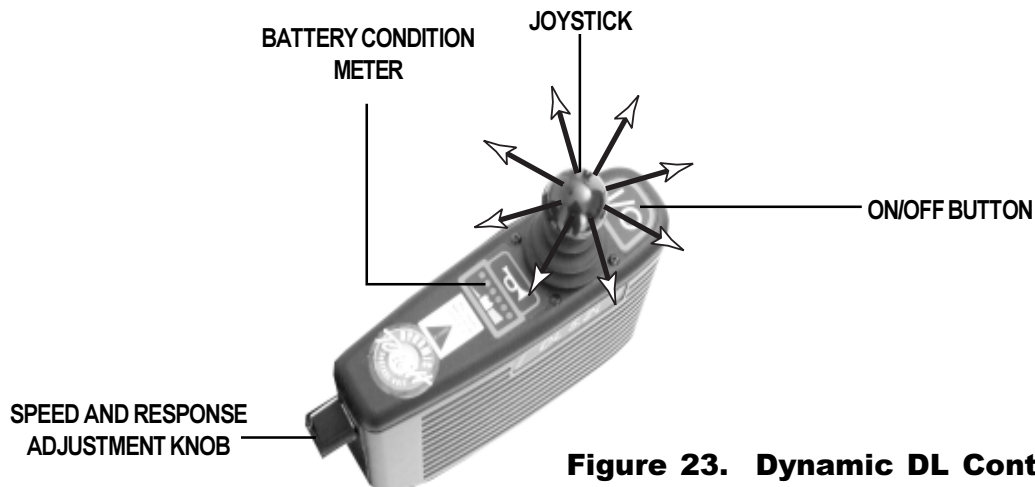

Figure 23. Dynamic DL Controller

Battery Condition Meter

The battery condition meter is located immediately behind the joystick. This enables you to monitor battery charge. The battery condition meter indicates the approximate amount of battery charge left. See figure 23.

- Red, yellow, and green LEDs indicate that the batteries are fully charged.
- Red and yellow LEDs indicate that you should charge the batteries if possible.
- Red LEDs indicate that you should charge the batteries as soon as possible, because low battery voltage may cause your Jet 10 to become inoperative.

VIII. OPERATION

Trouble Codes

In addition to indicating the current state of battery charge, the battery condition meter can also indicate possible problems with your Jet 10. If the battery condition meter is flashing rapidly, the controller may be indicating a fault. The following is a list of the possible errors signified by the rapidly flashing meter.

Flash Code Sequence	Diagnosis	Solution
•—•—•—	Low battery voltage fault	Check batteries/battery wiring.
••—••—•—	High battery voltage fault	Check batteries.
•••—••—	Left motor (or connection) fault	Check left motor wiring.
••••—•••—	Right motor (or connection) fault	Check right motor wiring.
•••••—••••—	Left or right park brake (or connection) fault	Check motor/brake wiring.
••••••—•••••—	Controller fault	See your authorized Pride provider.
•••••••—••••••—	Motor stalled or joystick out of neutral time out	Reset the power on/off button.

The symbol “•” means all 6 LEDs flash on for a period of 0.2 seconds and off for 0.8 seconds.

The symbol “—” means all 6 LEDs are off for a period of two seconds before flashing sequence repeats.

NOTE: You must turn the controller off and then on again to reset the controller, even if the source of the fault is removed/corrected.

In the event of a fault, the flashing battery condition meter displays diagnostic indications. Faults are encoded as follows: one (for a low battery voltage fault) to seven (for a motor stalled or joystick out of neutral time out fault) and are displayed by all LEDs flashing the number of times prescribed by the fault code. The flash sequence (one to seven) is followed by a long off period (2 seconds). If more than one fault exists, then the fault having the highest priority is indicated. The controller must be turned off and then on again even if the source of the fault is removed. If you cannot resolve the problem, contact your authorized Pride provider.

Thermal Rollback

The Jet 10 controller is equipped with a thermal rollback circuit. This circuit monitors the temperature of the motors and the controller. In the event that the motors or the controller become excessively hot (above 122° F), the controller reduces the motor voltage. For every degree above 122° F, the controller reduces the voltage by 5 volts. This reduces your Jet 10's speed and allows the electrical components to cool down. When the temperature returns to a safe level, your Jet 10 resumes its normal speed capability.

IX. BATTERIES AND CHARGING

BATTERIES

Your Jet 10 uses two long-lasting, 12-volt, deep-cycle batteries. These batteries are sealed and maintenance free. Since they are sealed, there is no need to check the electrolyte (fluid) level. Deep-cycle batteries are designed to handle a longer and deeper discharge. Though they are similar in appearance to automotive batteries, they are not interchangeable. Automotive batteries are not designed to handle a long, deep discharge, and also are unsafe for use in power chairs.



WARNING! Battery posts, terminals, and related accessories contain lead and lead compounds. Wash hands after handling.

WARNING! Always protect batteries from freezing temperatures and never attempt to charge a frozen battery. This damages the battery and may cause personal injury. Attempting to charge a battery in freezing conditions does not prevent a battery from freezing.

CHARGING THE BATTERIES

The onboard battery charger is essential in providing long life for your Jet 10 batteries. See figure 24. This charger is designed to optimize your Jet 10's performance by charging the batteries safely, quickly, and easily. The charging system consists of the charger, the charger fuse, and the ammeter. The ammeter is located on the outside of the power base for easy viewing. See figure 4. The charger has an in-line fuse that protects the ammeter. The ammeter indicates the rate of charge necessary to fully recharge the batteries. It is also a good indication of whether or not the charger is working. The ammeter and the charger are only functional when the charger power cord is plugged into a wall outlet.



WARNING! Never use an extension cord to plug in your battery charger. Plug the charger directly into a properly wired standard wall outlet.

WARNING! You must recharge your power chair's batteries with the supplied onboard or the supplied off-board charging system. Do not use an automotive-type battery charger.

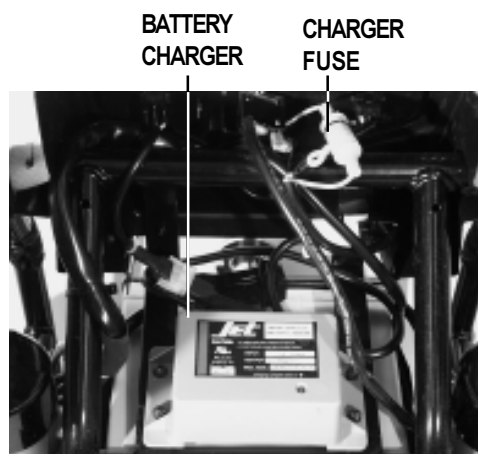

Figure 24. Onboard Battery Charger

IX. BATTERIES AND CHARGING

To charge the batteries using the onboard charger:

1. Position the rear of your Jet 10 close to a standard wall outlet.
2. Be certain the controller power is turned off and the manual freewheel levers are in the engaged position. See IV. "Your Jet 10."
3. Remove the battery charger cord from the back pouch of your Jet 10 and plug it into the battery charger AC power cord receptacle located on the power base. See figure 4.
4. Extend the charger power cord and plug it into the wall outlet. The Jet 10 incorporates an inhibit function that disables the power chair when the charger is plugged into a wall outlet.
5. The ammeter indicates how much charge is needed to fully charge the batteries. Wait about a minute for the charger to warm up. The ammeter may move as high as 5.5 amps, then gradually move back down to zero amps as the batteries charge.
6. We recommend you charge the batteries for 8 to 14 hours. As the batteries charge, the ammeter needle slowly drops to zero. When the batteries are fully charged, the needle vibrates on or about the zero mark on the ammeter scale.
7. When your Jet 10's batteries are fully charged, you can unplug the power cord from the wall outlet, wind it up using the hook and loop strap, and place the cord back into the Jet 10's back pouch.

OFF-BOARD CHARGER

If your Jet 10 is equipped with an off-board charger, follow these instructions.

1. Position your Jet 10 next to a standard wall outlet.
2. Be certain the controller power is turned off.
3. Remove the run plug (located where the charger harness would normally plug into the power base). See figure 4. This activates the inhibit function.
4. Plug the 3-pin extension cable from the charger into the connector where the run plug was removed.
5. Plug the charger into the wall outlet.
6. The ammeter indicates how much charge is needed to fully charge the batteries. Wait about a minute for the charger to come up to normal operating temperature. The ammeter should move to 5 amps, then gradually move back down to 0 amps. As the batteries are charged, the ammeter needle will slowly drop to zero. When the batteries are fully charged, the needle vibrates on or about 0 amps. We recommend you charge the batteries for 8 to 14 hours.
7. When your Jet 10's batteries are fully charged, disconnect the charger cord from the wall outlet and the charger from the power base.
8. Reconnect the run plug into its connector.

NOTE: If the run plug is not reconnected, your Jet 10 will not run.

BATTERY BREAK-IN

To break in new batteries for maximum efficiency:

1. Fully recharge any new battery prior to its initial use. This brings the battery up to about 90% of its peak performance level.
2. Operate your Jet 10 throughout the house and yard. Move slowly at first, and don't stray too far until you become accustomed to the controls and break in the batteries.

IX. BATTERIES AND CHARGING

3. Give the batteries another full charge of 8 to 14 hours and operate your Jet 10 again. The batteries will now perform at over 90% of their potential.
4. After four or five charging cycles, the batteries will top off at 100% charge and last for an extended period.

BATTERIES AND CHARGING—FREQUENTLY ASKED QUESTIONS (FAQS)

How does the charger work?

The battery charger takes the standard wall outlet voltage of 120 VAC (alternating current) and converts it to 24 VDC (direct current). The Jet 10 batteries use direct current to run your power chair. When the battery voltage is low, the charger works harder to charge the battery. This is why the charging ammeter initially reads five or more amps. As the battery voltage approaches full charge, the charger doesn't work as hard to complete the charging cycle. This explains why the charging ammeter drops as it approaches a full charge. When the battery is fully charged, the amperage from the charger is nearly at zero. This is how the charger maintains a charge but does not overcharge the battery.

Can I use a different battery charger?

You should use the charger supplied with the Jet 10. It is the safest, most efficient tool to charge the batteries. We do not recommend using other types of chargers (e.g., an automotive battery charger). Your Jet 10's charger will not operate after the batteries have been discharged to nearly zero voltage. If this happens, call your authorized Pride provider for assistance.

How often must I charge the batteries?

Many factors come into play when deciding how often to charge the batteries. You may use your Jet 10 all day on a daily basis or you may not use it for weeks at a time.

- **DAILY USE**

If you use your Jet 10 on a daily basis, charge the batteries as soon as you are finished using your power chair. Your Jet 10 will be ready each morning to give you a full day's service. It is recommended that you charge the batteries 8 to 14 hours after daily use. Do not charge the batteries for more than 24 hours at a charging cycle.

- **INFREQUENT USE**

If you use your Jet 10 infrequently (once a week or less), you should charge the batteries at least once per week for 12 to 14 hours.

NOTE: Keep your batteries fully charged and avoid deeply discharging them. Do not charge the batteries for more than 24 hours at a charging cycle.

How can I get maximum range or distance per charge?

Rarely do you have an ideal driving situation, such as smooth, flat, hard terrain with no hills or curves. More often you are presented with hills, sidewalk cracks, uneven and loosely packed surfaces, curves, and wind. All of these factors will affect the distance or running time per battery charge. Below are a few suggestions for obtaining the maximum range per charge:

IX. BATTERIES AND CHARGING

- Always charge the batteries fully prior to your trip.
- Plan your trip in advance to avoid inclines if possible.
- Limit baggage weight to essential items.
- Try to maintain an even speed and avoid stop-and-go driving.

What type of battery should I use?

We recommend deep-cycle batteries that are sealed and maintenance free. Both sealed AGM and Gel-Cell are deep-cycle batteries that are similar in performance

Use these specifications to reorder deep-cycle batteries:

Battery Specifications	
Type:	Deep-cycle (AGM or Gel-Cell)
Size:	NF-22
Voltage:	12V each



WARNING! Corrosive chemicals contained in batteries. Use only AGM or Gel-Cell batteries to reduce the risk of leakage or explosive conditions.

Why do my new batteries seem weak?

Deep-cycle batteries employ a much different chemical technology than that used in car batteries, nickel-cadmium (nicads), or in other common battery types. Deep-cycle batteries are specifically designed to provide power, drain down their charge, and then accept a relatively quick recharge. Lead-acid batteries should be charged as often as possible. They do not have a “memory” like nickel-cadmium batteries.

We work closely with our battery manufacturer to provide a battery that best suits your Jet 10’s specific demands. Fresh batteries arrive regularly at Pride and are promptly shipped with a full charge. During shipping, the batteries encounter temperature extremes that may influence initial performance. Heat robs the charge from the battery, and cold slows the power available and extends the time needed to recharge the battery (just as with a car battery).

It might take a few days for the temperature of the battery to stabilize and adjust to its new ambient temperature. More importantly, it will take a few “charging cycles” (a partial drain— then a full recharge) to establish the critical chemical balance that is essential to the battery’s peak performance and long life. It will be well worth it to take the time to break in your battery properly.

NOTE: The useful life of a battery is quite often a reflection of the care it receives.

How can I ensure maximum battery life?

A fully charged deep-cycle battery will provide reliable performance and extended battery life. Keep your Jet 10’s batteries fully charged whenever possible. Batteries that are regularly and deeply discharged, infrequently charged, or stored without a full charge may be permanently damaged, causing unreliable Jet 10 operation and limited battery life.

IX. BATTERIES AND CHARGING

How should I store my Jet 10 and its batteries?

If you do not use your Jet 10 regularly, we recommend maintaining battery vitality by charging the batteries at least once per week. If you do not plan on using your Jet 10 for an extended period, fully charge the batteries prior to storage. Disconnect the battery harnesses and store the Jet 10 in a warm, dry environment. Avoid temperature extremes, such as freezing and excessively hot conditions, and never attempt to charge a frozen battery. A cold or frozen battery should be warmed for several days prior to recharging.

NOTE: If you are storing your Jet 10 for an extended period of time, you may wish to block the unit up with several boards under the frame. This will keep the tires off the ground and prevent the possibility of flat spots developing on the tires.

What about public transportation?

Sealed lead-acid and gel cell batteries are designed for application in power chairs and other mobility vehicles. These batteries are Federal Aviation Administration (FAA) approved. They are safe for transportation on aircraft, buses, and trains, as there is no danger of spillage or leakage. We suggest you contact the carrier's ticket counter in advance to determine the carrier's specific requirements.

What about shipping?

If you wish to use a freight company to ship your Jet 10 to your final destination, repack your Jet 10 in the original shipping container and ship the batteries in separate boxes.

X. CARE AND MAINTENANCE

ROUTINE MAINTENANCE

Your Jet 10 is a sophisticated power chair. Like any motorized vehicle, it requires routine maintenance checks. You can perform some of these checks, but others require assistance from your authorized Pride provider. Preventive maintenance is very important. If you follow the maintenance checks in this section as scheduled, you can help ensure that your Jet 10 gives you years of trouble-free operation. If you have any doubt as to your Jet 10's care or operation, contact your authorized Pride provider.



CAUTION! Your power chair, like most electrical equipment, is susceptible to damage from the elements. Avoid damp areas of any kind. Direct exposure to water or dampness could cause the power chair to malfunction electronically and mechanically. Water can cause electrical components to corrode and the power chair's frame to rust.

Should your Jet 10 come in contact with water:

1. Dry your Jet 10 as much as possible with a dry towel.
2. Allow your Jet 10 to sit in a warm dry place for twelve hours to allow unseen water to evaporate.
3. Check the joystick operation and the brakes before using your Jet 10 again.
4. If any inconsistencies are found, take your Jet 10 to your authorized Pride provider.

TEMPERATURE

Some of the parts of your Jet 10 are susceptible to extreme changes in temperature. Always keep your Jet 10 between the temperatures of 18° F and 122° F.

- In extremely cold temperatures the batteries may freeze. The specific temperature at which they will freeze depends on a number of factors, such as battery charge, usage, and composition of the batteries (e.g., sealed lead-acid or gel cell).
- Temperatures above 122° F may cause your Jet 10 to operate at a reduced speed. This is a safety feature built into the controller that helps prevent damage to the motor and other electrical components. See VIII. "Operation."

GENERAL GUIDELINES

- Avoid knocking or bumping the controller, especially the joystick.
- Avoid prolonged exposure of your Jet 10 to extreme conditions, such as heat, cold, or moisture.
- Keep the controller clean.
- Check all controller connectors on the utility tray to ensure that they are all tight and secured properly. See figures 9 and 10. Also check the charger harness connector.
- When the battery condition meter is completely lit, the batteries are fully charged and the controller and the electrical system are OK.
- If two red LEDs on the battery condition meter are blinking slowly, the batteries are low and need to be charged, but the controller and the electrical system are OK.
- Make sure the drive tires are inflated to **30 - 35 psi**.



WARNING! Make sure your tires are inflated to 30-35 psi. Do not underinflate or overinflate your tires. Low pressure may result in loss of control, and overinflated tires may burst. Serious personal injury may result. Overinflating tires can cause them to explode and can result in personal injury.

WARNING! Do not use a high pressure hose to inflate your tires.

X. CARE AND MAINTENANCE

- If the battery condition meter is blinking rapidly, the controller has detected a fault in either its own circuits or in your Jet 10's circuits. See VIII. "Operation."
- Use a rubber conditioner on the tire sidewalls to help preserve them. Check for wear.



WARNING! Never use a rubber conditioner on the tread area of the tires; doing so may make the tires slippery and cause your power chair to skid.

- The body shroud has been sprayed with a clear sealant coating. You can apply a light coat of car wax to help it retain its high-gloss appearance.
- Check all electrical connections. Make sure they are tight and are not corroded. Batteries must sit flat within the battery well, with the battery terminals facing inward, toward each other. Refer to the frame decal for the correct wiring layout.
- All wheel bearings are prelubricated and sealed. They require no subsequent lubrication.

DAILY CHECKS

- With the controller turned off, check the joystick. Make sure it is not bent or damaged and that it returns to center when you release it. Check the rubber boot around the base of the joystick for damage. Visually inspect the boot. Do not handle or try to repair it. See your authorized Pride provider if there is a problem.
- Visually inspect the controller harnesses. Make sure that they are not frayed or cut or have any wires exposed. See your authorized Pride provider if there is a problem with any of these harnesses.

WEEKLY CHECKS

- Disconnect and inspect the controller and the charger harnesses from the utility tray. Look for corrosion. Contact your authorized Pride provider if necessary.
- Ensure that all parts of the controller system are securely fastened to your Jet 10. Do not overtighten any screws.
- Calibrate the joystick if a noticeable difference in performance is detected or if the joystick does not operate properly. To calibrate the joystick, power off the unit, place the joystick in neutral position, and power the unit back on. If a problem still exists with your joystick's performance, contact your authorized Pride provider.
- Check the brakes. This test should be carried out on a level surface with at least three feet of clearance around your Jet 10.

To check the brakes:

1. Turn on the controller and turn down the speed and response adjustment knob.
2. After one second, check the battery condition meter. Make sure that it remains on.
3. Slowly push the joystick forward until you hear the electric brakes click. Immediately release the joystick. You must be able to hear each electrical brake operating within a few seconds of joystick movement. Repeat this test three times, pushing the joystick backward, then left, and then right.

X . C A R E A N D M A I N T E N A N C E

MONTHLY CHECKS

- Check that the anti-tip wheels are not rubbing the ground when you are operating the Jet 10. Adjust them as necessary. See VI. “Comfort Adjustments.”
- Check for extreme wear on the anti-tip wheels. Replace them as necessary.
- Check for drive tire wear. See an your authorized Pride provider for replacement.
- Check the rear casters for wear. Replace them as necessary.
- Check the rear forks for damage or fluttering which indicates that they may need to be adjusted or have the bearings replaced. See an your authorized Pride provider for repair.
- Keep your Jet 10 clean and free of foreign material, such as mud, dirt, hair, food, and drink.

YEARLY CHECKS

Take your Jet 10 to an authorized Pride provider for yearly maintenance. This helps ensure that your Jet 10 is functioning properly and helps prevent future complications.

STORAGE

Your power chair should be stored in a dry place, free from temperature extremes. When storing, disconnect the batteries from the Jet 10. See IX. “Batteries and Charging.”



WARNING! If you fail to store the unit properly, the frame can rust and the electronics can be damaged.

CLEANING INSTRUCTIONS



CAUTION! Never hose off your power chair or place it in direct contact with water. Your Jet 10 has a painted, ABS plastic body shroud that allows it to be easily wiped clean with a damp cloth.

CAUTION! Never use any chemicals to clean a vinyl seat, as they may cause the seat to become slippery or dry out and crack. Use soapy water and dry the seat thoroughly.

WHEEL REPLACEMENT

Your Jet 10 is equipped with solid tires. Periodically check the tires for excessive wear. If your tire requires replacement, you must replace the entire wheel assembly. Replacement wheel assemblies are readily available at your authorized Pride provider.

Follow these easy steps for a quick and safe wheel replacement:

1. Use a 5/32-in. hex key to remove the hub cap. See figure 25.
2. Use an 11/16-in. wrench to remove the drive wheel nut from the center hub of the wheel. See figure 26.
3. Pull the wheel assembly off of the axle.
4. Slide the new wheel assembly back onto the axle.
5. Install the drive wheel nut into the center hub and tighten.
6. Install the hubcap.

X. CARE AND MAINTENANCE



Figure 25. Drive Wheel Hub Cap Removal



Figure 26. Drive Wheel Nut Removal

BATTERY REPLACEMENT

Refer to the battery diagram that is printed on a label located on the Jet 10 frame near the battery tray.



WARNING! The power chair batteries are heavy. Refer to the specifications table. If you are unable to lift that much weight, be sure to get help. Lifting above your capacity to do so can result in personal injury.

WARNING! Battery posts, terminals, and related accessories contain lead and lead compounds. Wash hands after handling.

WARNING! Always protect the batteries from freezing and never charge a frozen battery. This damages the battery and may result in personal injury.

To replace the batteries:

1. Turn the power off.
2. Unplug the 9-pin controller harness and the charger harness. See figure 9 and 10.
3. Remove the seat.
4. Remove the body shroud.
5. Loosen and remove the nuts on the positive battery terminals first.
6. Remove the wires.
7. Loosen and remove the nuts on the negative battery terminals.
8. Remove the wires.
9. Remove the old batteries.
10. Install the new batteries into your Jet 10 with the terminal sides of the batteries facing inward, toward each other.

X. CARE AND MAINTENANCE

11. Connect the wire marked (+) to the closest positive (red) battery terminal.
12. Connect the wire marked (-) to the closest negative (black) battery terminal on the *other* battery.
13. Connect one circuit breaker harness to the empty positive terminal of one battery, and connect the other circuit breaker harness to the empty negative terminal of the *other* battery.
14. Retighten all nuts.
15. Replace the shroud and seat.

WHEN TO SEE YOUR AUTHORIZED PRIDE PROVIDER FOR SERVICE

The following symptoms could indicate a serious problem with your Jet 10. If necessary, contact your authorized Pride provider. When calling, have the model number, serial number, nature of the problem, and the trouble code, if available.



WARNING! Make sure you tighten the fasteners so that the connections are secure.

MOTOR BRUSHES

The electric motors that power your Jet 10 use carbon brushes. These brushes may become susceptible to wear over a long period of time. The motor brushes are the two contacts located inside the motor assembly that supply power to the motor. They are designed to provide several thousand hours of operation. However, if the brushes become dirty with carbon deposits or wear out, the motor will run poorly or not at all. We recommend that your authorized Pride provider inspect the brushes every six months, or sooner if your Jet 10 runs poorly.



CAUTION! If inspection determines excessive wear on the brushes, they must be replaced or motor damage will result. Failure to maintain the brushes could void the warranty.

To inspect or replace the motor brushes:

1. Remove the seat and body shroud. See VII. "Disassembly."
2. Unscrew the motor brush caps. See figure 27.
3. Remove the brushes.
4. Inspect for wear. See figure 28.
5. Replace brushes, if necessary. Contact your authorized Pride provider for replacement brushes.

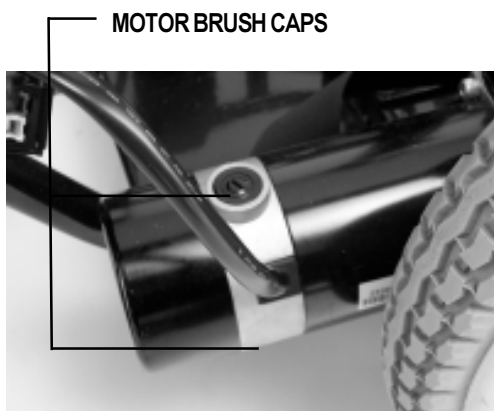

Figure 27. Motor

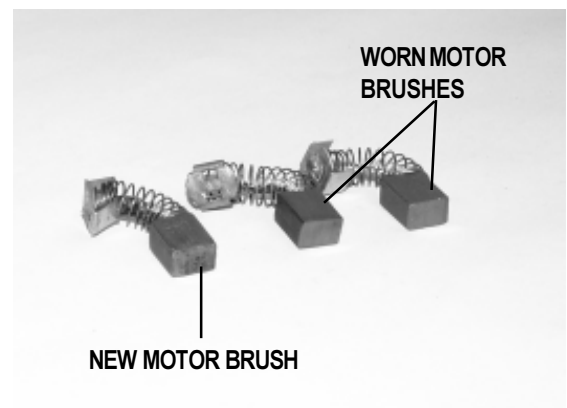

Figure 28. Motor Brushes

X. CARE AND MAINTENANCE

- Motor noise
- Frayed harnesses
- Cracked or broken connectors
- Uneven wear on any of the tires
- Jerky motion
- Pulling to one side
- Bent or broken wheel assemblies
- Does not power up
- Powers up, but does not move

CORRECTIVE MAINTENANCE

If the battery condition meter does not light up when you turn on the power:

- Check the 9-pin controller connector and the charger harness connector. See figures 9 and 10. Make sure they are tight.
- Check the circuit breaker. Reset it if necessary.
- Check the battery connections.

If the above conditions prove normal, you can load test the batteries with a battery load tester. These testers are available at automotive parts stores. Disconnect both batteries before load testing and follow the directions that come with the load tester. If either one of the batteries fails the load test, replace both of them. If your Jet 10 still does not power up, contact your authorized Pride provider.

XI. OPTIONS AND ACCESSORIES

The following options and accessories are available from your authorized Pride provider.

OXYGEN TANK HOLDER

The removable oxygen tank holder is mounted to the back of the seat by means of the accessory bracket.

CANE AND CRUTCH HOLDER

The removable cane and crutch holder is mounted to the back of the seat by means of the accessory bracket.

WALKER HOLDER

The removable walker holder is mounted to the back of the seat by means of the accessory bracket. It can hold a standard size walker.

REAR BASKET

The rear basket is mounted to the accessory bracket. It has a handle that you can use when you remove the basket from your Jet 10.

CUP HOLDER

The cup holder is mounted to the armrest.

XII. WARRANTY

FIVE-YEAR LIMITED FRAME WARRANTY

There will be a five-year limited frame warranty on Pride workmanship.

ONE-YEAR LIMITED WARRANTY

For one (1) year from the date of purchase, Pride will repair or replace at our option to the original purchaser free of charge, any of the following parts found upon examination by an authorized representative of Pride to be defective in material and/or workmanship:

- Electronic controllers and joystick assemblies
- Motor/gearbox assembly
- Main frame subassemblies (fork, caster beams, metal seat base, metal arms, metal foot plate)
- Plastic components except body
- Rubber components
- Bearings and bushings
- Caster and anti-tip wheels

WARRANTY EXCEPTIONS

Motor: The commutator of the motor is not warranted if the damage is caused by not replacing the motor brushes after heavy wear to the brushes. Motor brushes are wear items and are not warranted.

Brake: There is a one-year warranty for the electrical function of the brakes. Brake pads are wear items and are not warranted.

Battery: The battery is covered by the battery manufacturer. The battery warranty is not covered by Pride.

Warranty service can be performed by your authorized Pride provider. Do not return faulty parts to Pride without prior consent. All transportation costs and shipping damage incurred while submitting parts for repair or replacement are the responsibility of the original purchaser.

WARRANTY EXCLUSIONS

- ABS plastic body shrouds and footrest covers are wear items and not warranted.
- Batteries (battery manufacturer provides a six-month limited warranty)
- Tires and tubes
- Upholstery and seating
- Repairs and/or modifications made to any part without specific prior written consent from Pride
- Circumstances beyond the control of Pride
- Labor, service calls, shipping, and other charges incurred for repair of the product unless specifically authorized by Pride

Damage caused by:

- Battery fluid spillage or leakage
- Abuse, misuse, accident, or negligence
- Improper operation, maintenance, or storage
- Commercial use, or use other than normal

XII. WARRANTY

There is no other express warranty.

Implied warranties, including those of merchantability and fitness for a particular purpose, are limited to one (1) year from the date of purchase and to the extent permitted by law. Any and all implied warranties are excluded. This is the exclusive remedy. Liabilities for consequential damages under any and all warranties are excluded.

Some states do not allow limitations on how long an implied warranty lasts or do not allow the exclusion of limitation of incidental or consequential damages. The above limitation or exclusion may not apply to you.

This warranty gives you specific rights, and you may also have other rights which vary from state to state.

Please fill out and return the product registration card to Pride. This will aid Pride in providing the best possible technical and customer service.

JET

Power Chairs

Quality Control - Model JET 10



Thank you for making the Jet 10 your choice in Power Chairs.

We have thoroughly inspected your Jet 10. The following check marks indicate that it has been driven and inspected.



Pride keeps a more detailed report on file at the factory.

Date Inspected

Inspector