

User Manual

P100



Part Number No. 110439A Rev.1.1

© Polaroid

FOREWORD

This manual contains installation and operation information for the Polaroid P100 Series card printers manufactured by Polaroid Corporation.

RETURN MATERIALS AUTHORIZATION

Before returning any equipment to Polaroid Corporation for in-warranty or out-of-warranty repair, contact Repair Administration for a Return Materials Authorization (RMA) number. Repack the equipment in the original packing material and mark the RMA number clearly on the outside. Ship the equipment, freight prepaid, to the address given to you by Repair Administration.

COPYRIGHT NOTICE

This document contains information proprietary to Polaroid Corporation. This document and the information contained within are copyrighted by Polaroid Corporation and may not be duplicated in full or in part by any person without written approval from Polaroid. While every effort has been made to keep the information contained within current and accurate as of the date of publication, no guarantee is given or implied that the document is error-free or that it is accurate with regard to any specification. Polaroid reserves the right to make changes, for the purpose of product improvement, at any time.

TRADEMARKS

Polaroid P100 is a pending service mark. Polaroid is a registered trademark of Polaroid Corporation, Cambridge, MA. All other marks may trademarks or registered trademarks of their respective holders.



WARRANTY INFORMATION

WE NEED TO HEAR FROM YOU!

To establish your warranty period and provide access to technical support, send us your warranty registration card today!

Polaroid warrants the mechanism, control electronics and power supply, under normal use and service, to be free from defects in material and workmanship for a period of twelve (12) months from the date of purchase by the end user. Polaroid warrants the print head, under normal use and service, to be free from defects in material and workmanship for a period of twelve (12) months from the date of purchase by the end user. Proof of purchase or Product registration is required. If proof of purchase or product registration cannot be established, shipment date to the original buyer (dealer or distributor) will be used to establish the warranty period.

Failure to exercise caution to protect the equipment from electrostatic discharge damage, adverse temperature and humidity conditions or physical abuse, including, but not limited to, improper packaging, shipping, service or repairs performed by personnel not authorized by Polaroid may void the warranty. Failure to use only Polaroid approved media may void the warranty. Polaroid will, at its option, repair or replace the equipment or any parts which are determined to be defective within this warranty period, and which are returned to Polaroid.

The warranty set forth above is exclusive and no other warranty, whether written or oral, is expressed or implied. Polaroid specifically disclaims the implied warranties of merchantability and fitness for a particular purpose.

DECLARATIONS OF CONFORMITY



European Council Directive		Compliance to Standards	
89/336/EEC modified by 92/31/EEC and 93/68/EEC	EMC Directive	EN 55022-B	RF Emissions control
	EMC Directive	EN 500082-1, 1992	Immunity to Electromagnetic Disturbances
73/23/EEC modified by 93/68/EEC	Low voltage Directive	EN 60950	Product Safety



Model: P100 conforms to the following specification:
FCC Part 15, Subpart A, Section 15.107(a) and Section 15.109(a)
Class A digital device

Supplemental Information:

This device complies with Part 15 of the FCC Rules. Operation is subject to the following two conditions: (1) This device may not cause harmful interference, and (2) this device must accept any interference received, including interference that may cause undesired operation.

Note:

This equipment has been tested and found to comply with the limits for a class A digital device, pursuant to Part 15 of the FCC Rules. These limits are designed to provide reasonable protection against harmful interference when the equipment is operated in a commercial environment. This equipment generates, uses, and can radiate radio frequency energy and, if not installed and used in accordance with the instruction manual, may cause harmful interference to radio communications. Operation of this equipment in a residential area is likely to cause harmful interference in which case the user will be required to correct the interference at his own expense.

INDUSTRY CANADA NOTICE

This device complies with Industry Canada ICS-003 class A requirements.
Cet équipement est conforme à l'ICS-003 classe A de la Norme Industrielle Canadienne.



INTRODUCTION

Thank you for choosing the Polaroid 100 Plastic Card Printer.

These printers produce cards ideal for personalised identification, access control, visitor, membership, promotion and luggage card, badges and tags.

This manual guides you to efficient start up and operation of your new Card Printer.

P100 PRINTER MODELS

The Polaroid Product Number tells a story:

Here is a quick review of the Polaroid Card Printer Series numbering and lettering system to help you.

The P100 Plastic Card Printer employs Dye Sublimation and Resin Thermal Transfer technologies. Model numbers include identifiers that specify options are shown using the following lettering conventions:

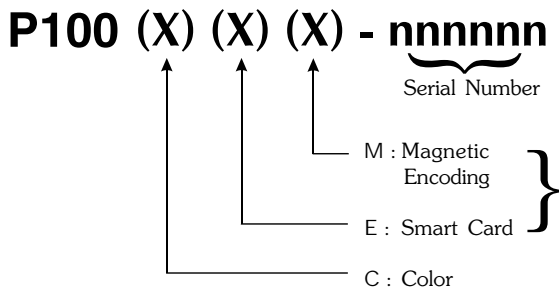

ICONS

Throughout this manual, different icons highlight important information, as follows:



Important general information



Mechanical hazard, such as one associated with moving parts, capable of resulting in equipment damage or personal injury.



Electrical hazard, such as an exposed voltage point, capable of causing electrical shock and personal injury.



An area where electrostatic discharge (ESD) can cause component damage. Use a grounding wrist band.



Elevated temperature hazard, capable of producing a burn.



Keep Card Printer clean by minimizing cover open time.

Table of Contents

1	GETTING STARTED	1
	1.1 Unpacking your card printer	1
	1.2 Indicators and controls	3
	1.3 Printer installation	4
2	OPERATION	5
	2.1 Printer Features	5
	2.2 Loading ribbons	6
	2.3 Loading cards	8
	A- Card Feeder	8
	B- Card Cleaning Cartridge	10
	C- Card Thickness Control Lever	11
	D- Card Output Hopper	11
	2.4 Reject Card Box	12
	2.5 Feeding one card at a time	14
	2.6 Printing a test card	15
	2.7 Printer menu information	16
3	PRINTING A SAMPLE CARD	19
	A- Install Driver on windows 95/98	20
	B- Install Driver on windows NT4.0	21
	C- Set Printer Driver Options	21
	D- Printing a Sample Card	22
4	CLEANING	23
	4.1 Cleaning system	24
	4.2 Cleaning the print head	25
	4.3 Card Cleaning Cartridge	26
5	TROUBLESHOOTING	29
	5.1 Interpreting LCD Display Messages	29
	5.2 Print Quality issues	32
6	TECHNICAL SPECIFICATIONS	35



APPENDIX A - MAGNETIC CARD STRIPE ENCODER	39
Introduction	39
A- Media Loading Orientation	40
B- Magnetic Encoder Cleaning	41
APPENDIX B - SMART CARD CONTACT STATION	42
Introduction	42
A- Media Loading Orientation	43
B- Smart Card Contact Station Interface	43
APPENDIX C - ACCESSORIES & SUPPLIES	44
Ribbons	44
Cards	45
Accessories	46



GETTING STARTED



1.1 Unpacking your card printer

Your P100 printer ships in a carton and protective anti-static bag. Keep all packing material in case you need to move or re-ship the printer.

While unpacking, inspect the carton to ensure that no damage occurred during shipping.

Please ensure that you have a clean and nearly dust free environment for proper operation and storage of the printer.



In addition to user documentation, make sure the following items are included with your P100 printer:

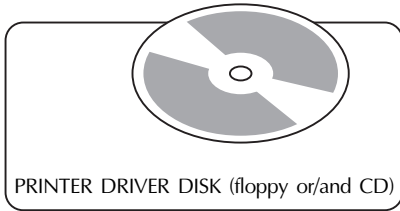
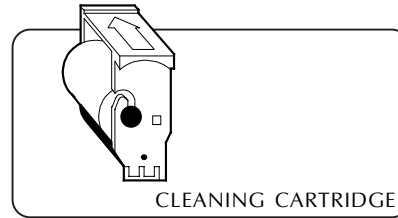
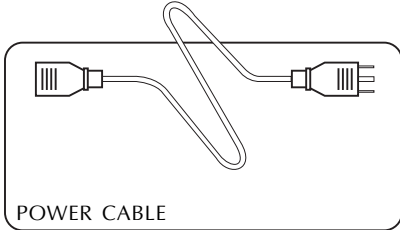
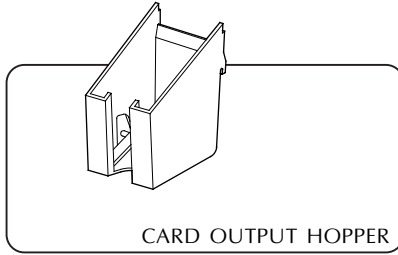
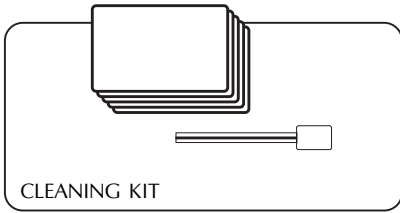

If any items are missing, please contact your dealer.

To reorder, please refer to Appendix C of this manual.



1.2 Indicators and Controls

Your P100 printer has an LCD Display, two LED's and two Panel Buttons.

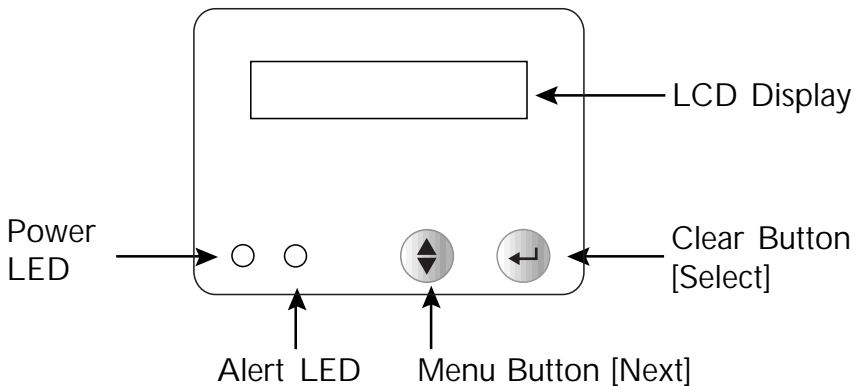

LCD Display :

The 16 character LCD Display is used for :

- Showing the printer's current status
- Providing operator and service messages (Chapter 5)

LED's :

The two LED's are used for :

- Green: Power LED
- Amber: Alert LED (with beeper)

This Alert LED is on when an error condition exists.

The Beeper will sound three alert "Beeps" and the LCD Display will show the associated error message.

PANEL BUTTONS:

The Menu Button (left) is a push button used for:

- Bringing printer into Menu Mode when pressed with the printer showing READY on the LCD Display.
- Using in Menu Mode to scroll through Menu Options.

The Clear Button (right) is a push button used for:

- Clearing an error status (when LCD Display shows an error report and Alert LED is on).
- Invoking automatic retry of the operation which gave the error.
- Selecting a Menu Option when in Menu Mode.

NOTE: the buttons beep when pressed



1.3 Printer Installation

The following will guide you through the installation of your P100 printer.



CAUTION : Limit AC power supplied to the P100 Printer to 110 - 230 V AC, 60 - 50 Hz for an associated 680 mA - 310 mA. Limit excess current draw to 16 amps or less, using an associated circuit breaker or other such device. Never operate the printer in a location where operator, computer, or printer can get wet. Personal injury could result. The printer must be connected to an earthed electrical power supply and properly protected against electrical surges and grounding faults.

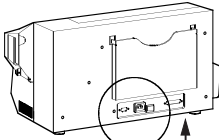

1. Place the printer in a location that allows easy access to all sides. The printer should never be operated while resting on its side or upside down.

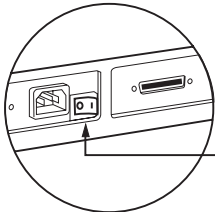

2. Place the printer's power switch in the OFF (0) position.

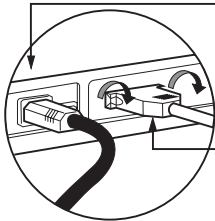

3. Insert the power cable to the printer power socket and attach to grounded electrical socket of the proper voltage and type.

4. Attach interface cable to printer and computer and then secure.

5. Switch power on.



CAUTION: Intermittent or unpredictable operation may occur from unsecured connectors. If damaged, the power cable must be replaced by an exact equivalent. Use only Parallel Cable under 3 Meters in length.



OPERATION

2.1 Printer Features

The following shows the features found on your P100 Printer:

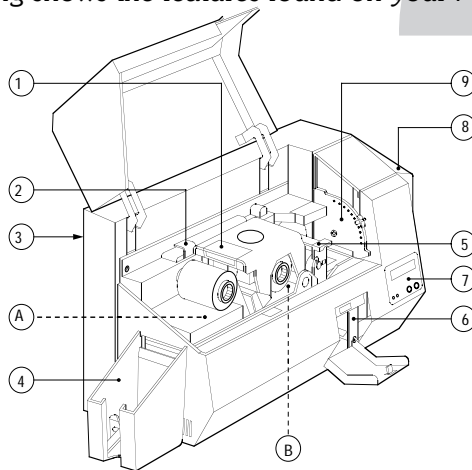

STANDARD FEATURES

1. Print Head
2. Print Head Unlock lever
3. Manual Holder
4. Card Output Hopper
5. Card Cleaning Cartridge
6. Rejected Card Box
7. LCD Display & 2 Panel Buttons
8. Card Feeder + cover
9. Card Thickness Control Lever

OPTIONAL FEATURES

- A. Magnetic Encoder Station
- B. Smart Card Contact Station

PLEASE NOTE : Any blue items inside the printer can be operated by the user.



2.2 Loading Ribbons

The P100 Printer requires approved ribbons (See Appendix C). The Resin Thermal Transfer and Dye Sublimation ribbons are specifically designed for your P100 Printer. For optimum performance and printer life (Print Head), always use approved ribbons.



DO NOT TOUCH the print head or the electronic components on the print head carriage. Discharges of electrostatic charge from the human body or other surfaces can damage the print head or other electronic components used in this device.

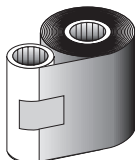

1. Remove ribbon from packaging.

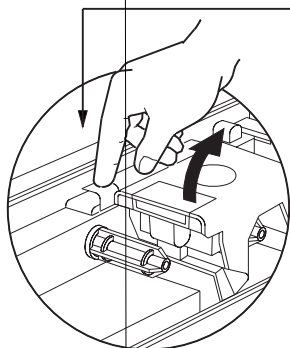
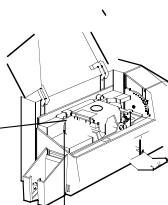

2. With printer power ON and READY status, open cover and press down on the Print Head Unlock Lever to open the print head carriage. The print head carriage will pop open.

Continued on next page



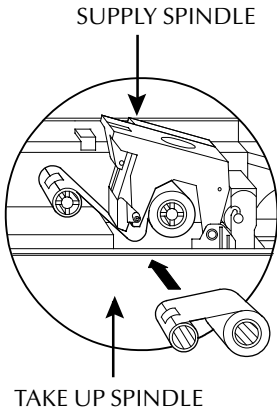

3. Load ribbon onto the supply spindle (under print head carriage) and empty core (with tape attached) onto the take-up spindle. Make sure the ribbon comes off the top of the supply spindle and feeds to the top of the take-up spindle.

'CLICK'

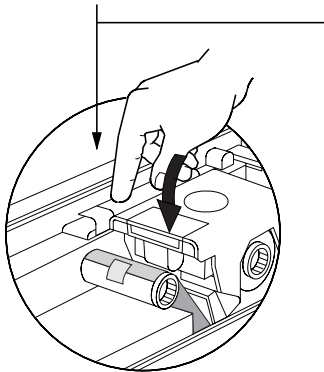

4. Push down on the Print Head Lock Lever until an audible 'click' signals the locked-down position.

5. Close Cover.



Please note that the ribbon automatically synchronizes whenever the print head lock down occurs.



The card flipper will not operate and an error will be indicated if you try to flip a card when the cover is open.



2.3 Loading Cards

To help you load, print, and collect cards, the P100 has the following items:

A - CARD FEEDER

This item is used for loading cards.

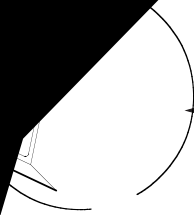

1. Open Card Feeder Cover by putting your fingers on both sides and rotating the cover in a clockwise direction to the open position.

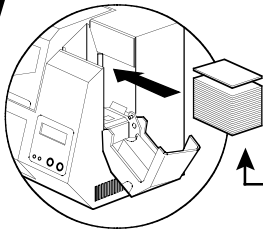

2. Install cards into Feeder* as shown.

3. Close Card Feeder Cover.





DO NOT bend cards or touch print surfaces as this can reduce print quality. The surface of the cards must remain clean and dust free. Always store cards in an enclosed container. Ideally, use cards as soon as possible. If cards stick together, carefully shuffle them.

* See Chapter 6, Technical Specifications, for card requirements and capacities.



B - INSTALL CARD CLEANING CARTRIDGE

This item is used to clean the cards entering the printer.

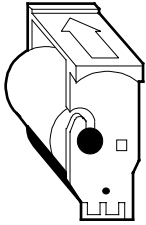

← ***1. Remove Card Cleaning Cartridge from packaging.***

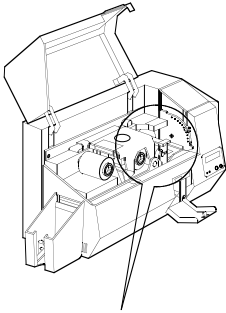

← ***2. Open Printer cover and remove the yellow reminder tape from the location for the Cleaning Cartridge.***

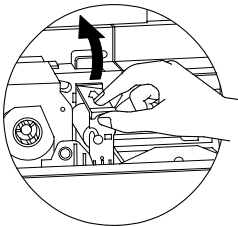

← ***3. Make sure the arrow on top of the assembly is facing toward the rear of the printer. Hook assembly into slot on printer and rotate down. Ensure the assembly locks in place.***

C- CARD THICKNESS CONTROL LEVER

This item is operated by the user to prevent more than one card feeding into the printer at the same time and causing a jam.

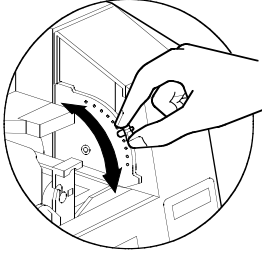

Open Cover, and adjust lever to the correct position for the card thickness you are using. Repeat for different card thickness. (Factory setting is for 30mil (0.762 mm) card thickness). See diagram below :

Card thickness:

A - 60mil (1.524mm) to 50mil (1.27mm)

B - 40mil (1.016mm)

C - 30mil (0.762mm)

D - 20mil (0.508mm)

E* - Less than 20mil (0.508mm)

* Start at lowest position and move lever up to match card thickness.

For other card thickness, start lever at lowest position and move up until cards feed.

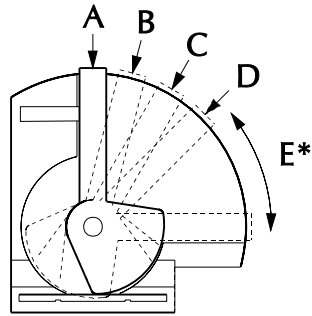

D - CARD OUTPUT HOPPER

This item is used for collecting printed cards.

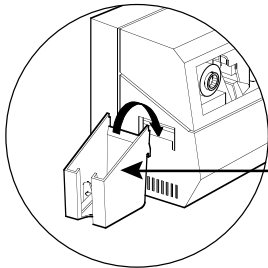

Install Card Output Hopper onto printer by hooking over bottom edge of card exit aperture.



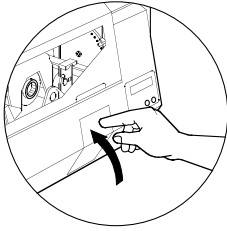

3. Swing up the Rejected Card Box Door and press the top. An audible "click" signals the locked position.

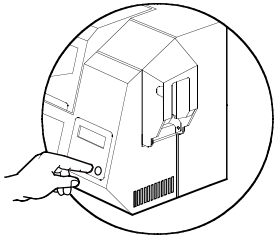

4. Press the Clear Button on the front panel to re-start the current printer job and to clear the rejected cards counter.



2.5 Feeding one card at a time

A Manual Feed Slot is available on the side of the Card Feeder cover for feeding single cards. Cleaning Cards are fed manually through this slot.

The Feeder must be empty for manual card feeding to work properly.

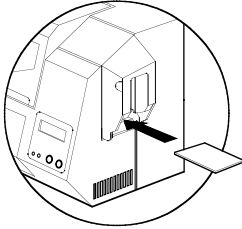

For one-at-a-time printing, feed cards through slot on side of Feeder.

Do not feed more than one card at a time.



6 *Printin*

ribbon and cards
the operation

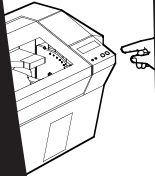
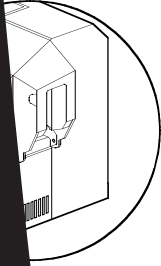

This i

RD PRINT
CEM
66

2.7 Printer Menu Information

The printer is equipped with a LCD Display and two key buttons which gives access to printer menus.

When the Menu button to enter the Menu Mode.



The top line display shows menu information. The second line of display clarifies the function of the two [NEXT] and [SELECT] key buttons relative to the current menu item.

The printer will return to READY Mode if either of the two key Buttons is not pressed within ten seconds of entering Menu mode.

See next page:

P100 LCD Menu Tree

*If the printer is equipped with a Magnetic Stripe Encoder



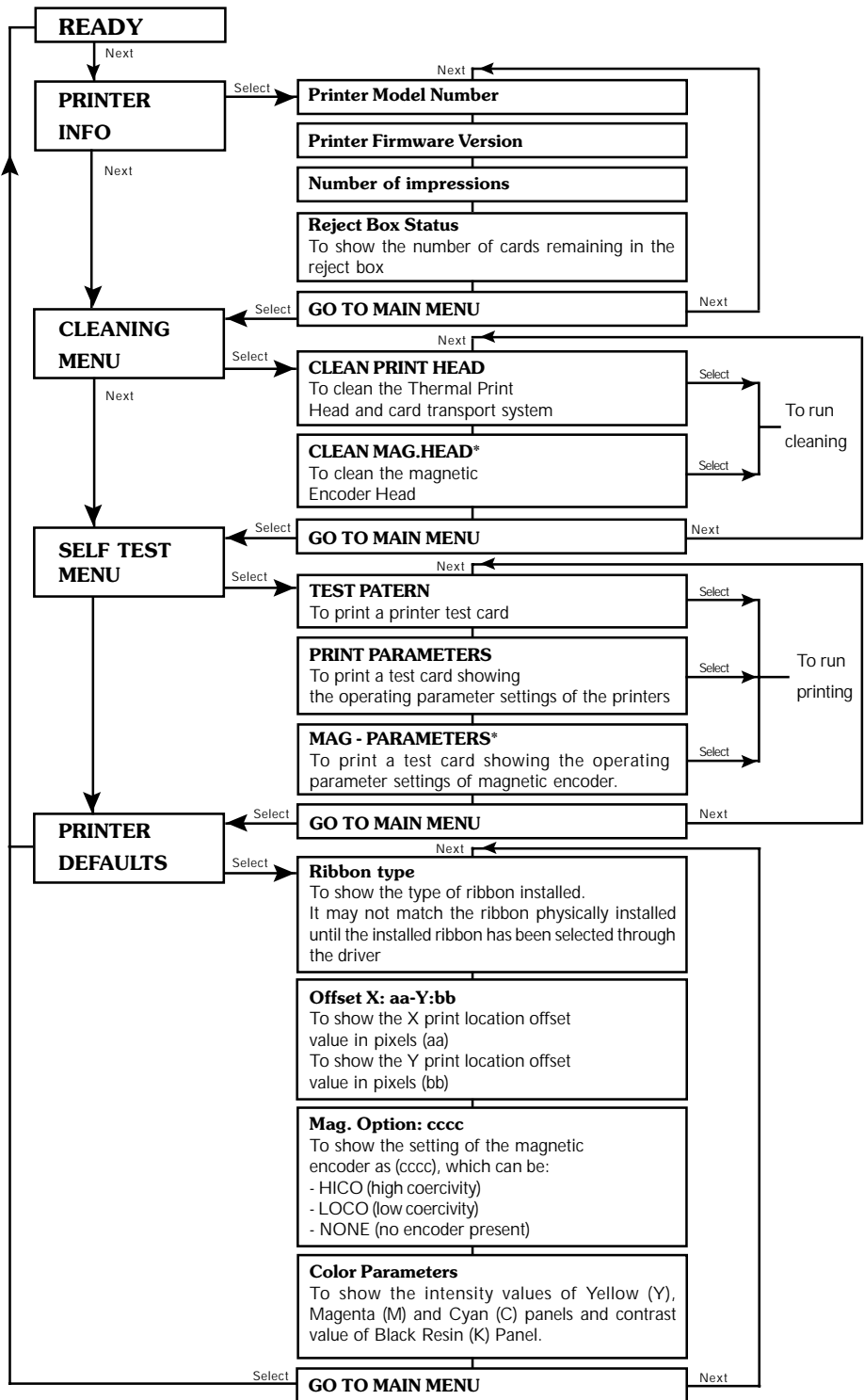



PRINTING A SAMPLE CARD

Printing with the P100 Printer requires the Windows Printer Driver, your card design/issuing software or printer command level programming through the printer interface.

The P100 Card Printer can be used with any Windows 95/98 or Windows NT 4.0 software application program, using the drivers provided with the printer.

This section contains information on the printing of a dual-sided card in color (using the 6-Panel color ribbon YMCKOK) and the Windows Printer Driver.



BEFORE installing updated printer driver versions, always delete the existing printer driver version from your computer.



A. To install the P100 Printer Driver in Windows 95/98, use the following steps:

IMPORTANT NOTE - ENSURE THAT YOUR PC PRINTER PORT IS SET TO STANDARD MODE AND ALSO ENSURE THAT YOU HAVE DELETED ANY PREVIOUS VERSIONS OF THIS PRINTER DRIVER. IF YOU HAVE ANY DOUBTS PLEASE CONTACT YOUR IT DEPARTMENT.

This installation uses floppy drive 'A' or from CD Rom as the installation drive with the printer used as stand alone.

- Start your computer and then Windows.
- Insert your 'Polaroid Driver' diskette into the drive 'A' or CD drive.
- Under Windows click the Start button, select Settings, then Printers.
- Double click on the Add Printer icon and also Next.
- Ensure Local Printer is selected and click on Next.
- Click on Have Disk and then type in 'A:\win95' and click OK.
- P100 CARD PRINTER should be displayed after which click on Next.
- Choose LPT1 : Standard Printer Port, click on Next, select Yes to set as Default Printer and click on Finish to install.

The Printer Wizard will copy the necessary files to the PC for you and the P100 printer driver installation will be completed.



B. To install the P100 Printer Driver in Windows NT4.0:

Ensure that you have administrative privileges to perform this installation or contact your Information Technology Department.

Set printer as Not Shared for stand alone use.

Use the steps provided for Windows 95/98 installation with the exception of step 6. where you must type in 'A:\nt40' instead and click OK.

Once the printer driver has been successfully installed, you will need to configure it for your printer. This driver provides control of several printer features when printing from Windows applications. These features are accessed through the P100 Plastic Card Printer Properties. To access these properties select the P100 Card Printer icon in Printers. Then click File Menu and select Properties.

C. Set Printer Driver Options

The P100 Printer screen appears. Change the options as follows:

- On the Printer tab configure the magnetic encoder feature. If your printer is equipped with a Magnetic Encoder option, select With Magnetic Encoder option.
- On the Card tab select card orientation:
Landscape or Portrait - Select 'Landscape'.
- On the Ribbon tab, select the Ribbon Type. Select YMCKOK for the standard 6-panel ribbon.
- In the same tab, go to Black Panel area and select Text Only. This option allows the text printing using the Black Resin Panel from the Color Ribbon.
- Close the Eltron P100 Printer Properties screen.

Now that you have loaded media and set up the printer driver, the P100 Printer is ready to print.



D. Printing a sample card:

Follow the steps to print your first card

- Go to the Microsoft Word Software.
- If the printer was not selected as the default printer, go to the File menu and Select Printer and choose Polaroid 100 Card Printer in the printer names list. Then Close the print dialog box.
- Come back to File menu and choose Page Setup.
- Select Paper Size tab and in Paper Size choose Card. Then select the orientation: "landscape".
- Go to Margins tab, put the Top, Bottom, left and right margins with 0 values.
- Press OK to close Page Setup window.
- The card appears on the screen.
- Design a card with 2 sides as follow:

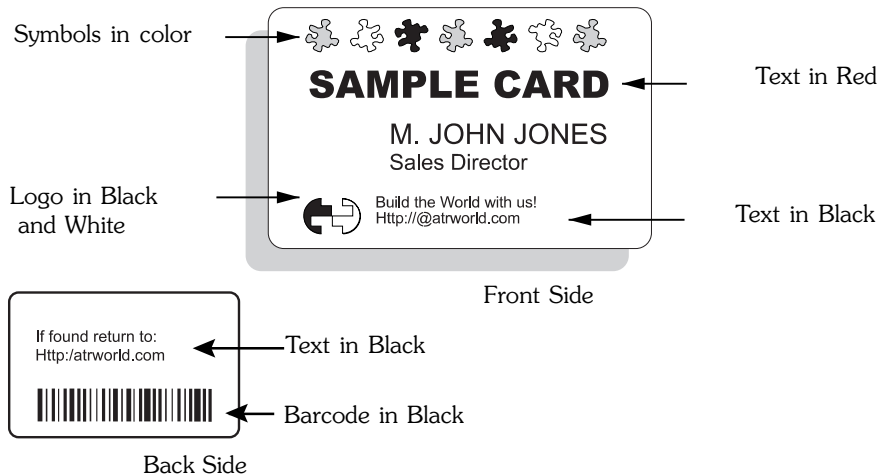

- Once you are ready to print, go to File and point Print
- The printer will feed in a card and start printing (the data download time will vary depending on the complexity of the card design and the processing speed of your computer).
- Once the printing job is achieved the card is ejected from the printer.



CLEANING



PROTECT YOUR FACTORY WARRANTY !

The recommended maintenance procedures must be performed to maintain your factory warranty.

Other than the recommended cleaning procedures described in this manual, allow only Polaroid authorised technicians to service the P100 Printer.

NEVER loosen, tighten, adjust, or bend, etc. a part or cable inside the printer.

NEVER use a high pressure air compressor to remove particles in the printer.



4.1 Cleaning System

Your P100 Printer includes a simple cleaning system using the Pre-Saturated Cleaning Cards provided. The regular use of these cards will clean and maintain important parts of your printer: including the Print Head, and Transport Rollers.

CLEAN PRINTER

WHEN TO CLEAN

When LCD screen reports message.

HOW TO CLEAN

1. Leave power on.
Open Cover and release Print Head Bracket to remove ribbon.
Close Print Head bracket.
Close Cover. Remove cards from Card Feeder.

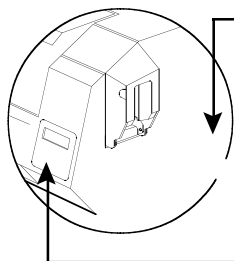

2. Insert one Pre-Saturated Cleaning Card (provided) through slot on the side of the Card Feeder Cover.

3. Press the right Panel Button for a few seconds. The card will feed into printer and carry out the cleaning process. Repeat the process with a new Cleaning Card if necessary.
Allow 2 minutes to dry before re-using the printer.

Note: For a printer cleaning prior to the WHEN TO CLEAN signal, press the Left Panel Button until the LCD screen shows "CLEANING MENU". Press the right Panel Button to select and one more time again to run the cleaning process (Repeat first steps 1 & 2 above).



Although the CLEAN PRINTER message is displayed until the cleaning process has been performed, the printer will continue to operate.

4.2 *Cleaning the Print Head*

A cleaning using the Cleaning System with cards usually suffices. However, a separate Print Head cleaning using swabs can remove more stubborn deposits when print anomalies persist. To avoid deposits, only use foam-tipped swabs.

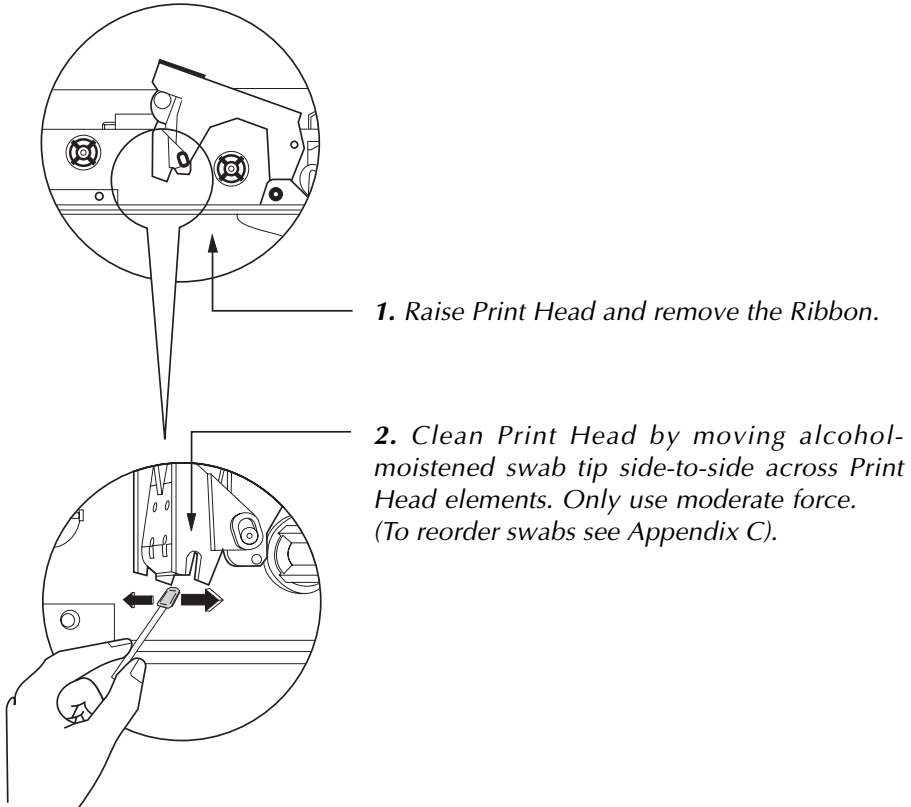

Never use a sharp object to scrape deposits from the print head. Permanent damage will result.



4.3 Card Cleaning Cartridge

Your P100 Printer also has a Card Cleaning Cartridge. This item cleans the cards entering the printer. To ensure print quality, the cleaning roller requires periodic replacements.

CLEAN PRINTER

WHEN TO MAINTAIN

When LCD screen reports message.
Run a printer cleaning first .
(see 4.1 Cleaning System for more instructions.)

HOW TO MAINTAIN

1. Open Cover and locate Cleaning Cartridge.

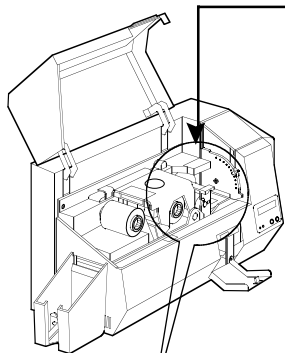

2. Gently remove Cleaning Cartridge by rotating up and away from printer.

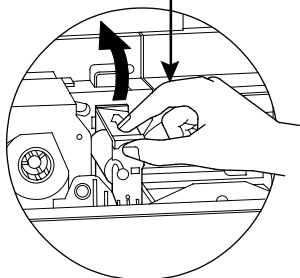

Continued on next page...



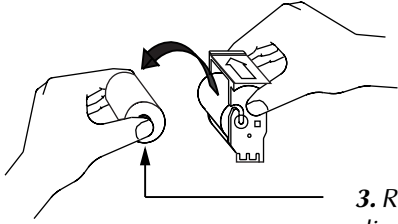

3. Remove Cleaning Roller from Cartridge and discard.

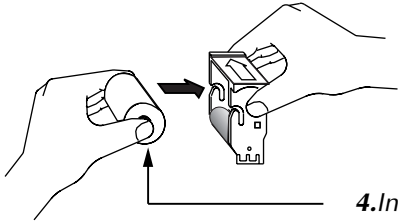

4. Install new Cleaning Roller into Cartridge*. To avoid contamination, always hold the Cleaning Roller assembly by the ends.

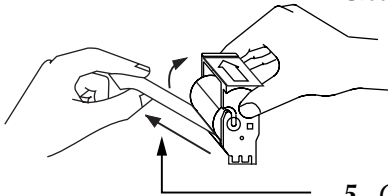

5. Carefully peel off wrapper from new Cleaning Roller while in Cartridge.

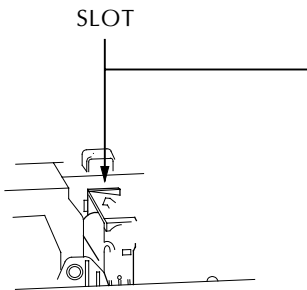

6. Replace Cartridge into printer. Make sure the arrow on top of the assembly is facing toward the rear of the printer. Hook assembly into slot on printer and rotate down. Ensure the assembly locks in place.

DO NOT touch the roller surface that contacts the cards.

7. Close Cover

* See Appendix C for replacement Cleaning Rollers.

Although the CLEAN PRINTER message is displayed until maintenance has been performed, the printer will continue to operate.



TROUBLESHOOTING

This section offers solutions to potential problems you may experience with your P100 printer. The table below lists the screen messages that will be displayed on the printer's LCD, both during normal operation and to alert operator of any error conditions. There is also some additional information dealing with quality issues concerning printing onto cards.

5.1 *Interpreting LCD Display messages*

SCREEN MESSAGE	MEANING	ACTION
INITIALISING	The printer is performing an internal test before use	Wait for the ready message
READY	Ready for use	
WAIT TEMPERATURE	Print Head cool down mode	Wait for READY message
SELF TEST	Self test card printing	Wait for test card
DOWNLOADING DATA	The card data is being transmitted	Wait for card printing to start
PRINTING YELLOW	The yellow panel is being printed	
PRINTING MAGENTA	The magenta panel is printing	
PRINTING CYAN	The cyan panel is printing	



SCREEN MESSAGE	MEANING	ACTION
PRINTING BLACK	A monochrome panel is being printed	
PRINTING VARNISH	The overlay is printing	
PRINT HOLOGRAM	A hologram overlay is printing	
CLEAN PRINTER	The printer is prompting operator maintenance	Carry out the cleaning procedure as detailed in section 4 of this manual
CLEAN MAG HEAD	The printer is prompting operator	Carry out the cleaning procedure as detailed in Appendix A of this manual
CLEANING	The printer is performing an internal cleaning routine	
REMOVE RIBBON	The ribbon has not been removed while the cleaning operation is in progress	Remove ribbon
OUT OF RIBBON	The printer ribbon has run out	Replace printer ribbon
MECHANICAL ERROR	The printer has an error moving the card internally	Remove the jammed card. Ensure that the card is not out of specification
OUT OF CARD	The card feeder is empty	Add more cards or adjust the card feeder to accept the cards
ROTATION ERROR	The printer has an error moving the card in the flip	Remove card
COVER OPEN	The cover is open	Close the cover
HEAD OPEN	The print head is not locked into position	Lock the print head in its lower position
COMMAND ERROR	The data being sent from the host is not recognised	Check that the data is suitable for printing. Try re-printing a card from known 'good' data
PARAMETERS ERROR	The features of the card are not recognised	Check the Windows driver options and printer type



SCREEN MESSAGE	MEANING	ACTION
ENCODING ERROR	Data cannot be written or read from the card's magnetic stripe	Check that the cards are loaded with the magnetic stripe in the correct orientation. Check whether high or low coercivity cards have been specified. Check that the data conforms to ISO specifications. See Appendix A of this manual for further information.
READING ERROR	Data cannot be read from the card's magnetic stripe	Check that the cards are loaded with the magnetic stripe in the correct orientation. Check whether high or low coercivity cards have been specified. Check that the data conforms to ISO specifications. See Appendix A of this manual for further information.
REJECT BOX FULL	The reject box is full	Empty the reject box and press the right panel button
MAGNETIC ERROR	The printer cannot detect a magnetic stripe on the card.	Check the card orientation
FLASH ERROR		Contact your dealer for technical support.
NO ACCESS		

Ribbon Errors: Check that the print ribbon has not 'run out'. Lock and then unlock the print head assembly; this resynchronises the ribbon automatically. When using a color ribbon, it should advance automatically so that the leading edge of the Yellow panel is beneath the print head. Ensure that the correct ribbon type has been specified in the Windows driver.

Card Feed & Mechanical Errors: Ensure that the card thickness adjustment has been set-up correctly to allow one card to feed.

Magnetic Encoding Errors: Check that the cards are inserted correctly in the printer. Ensure that the cards are low or high coercivity as required, and are set-up correctly in the printer driver.

Cleaning Alert: The printer has counted the number of cards printed and has automatically flagged that a cleaning routine needs to be carried out. (See Chapter 4).



5.2 Print Quality Issues

This section will help you resolve print quality problems. The print quality is dependent on several factors. The two most important factors that will increase your print quality are cleanliness and card stock. To diagnose and fix print quality problems, follow the troubleshooting procedure below:

• **Small spots appear on the printed card with a non-printed area or a different color.**

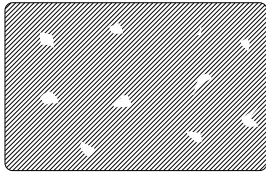

Possible Cause

A. Contamination on the card surface.

B. Dust inside the printer and/or dirty Cleaning Roller.

⇒ Solution

A1. Check that cards are stored in a dust free environment

A2. Use a different supply of cards.

B1. Perform a Cleaning of the printer (see Cleaning section).

B2. Replace Cleaning Roller (see Cleaning section).

• **There are non-printing horizontal lines (white) on the card surfaces.**



Possible Cause

A. Ribbons is not correctly positioned.

B. Print Head may be dirty.

C. Print Head elements may have been damaged (e.g. scratched or burnt).

⇒ Solution

A1. Open cover and press down the Print Head Unlock Lever to open the Print Head carriage. The Print Head will move up.

A2. Check that the ribbon is properly rolled onto the ribbon cores and there are no wrinkles in the ribbon.

A3. Push down on the Print Head Lock Lever until an audible «click» signals the locked-down position.

A4. Ribbon will automatically synchronize.

A5. Print again.

B1. Perform a Cleaning of the Print Head (see 4.2 Cleaning the Print Head.)

C1. Call service for Print Head replacement information.



•**Printing shows very pale or inconsistent results.**

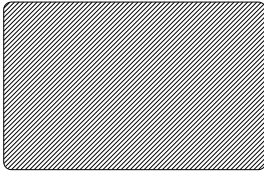

Possible Cause

- A. Ribbon may have been stored improperly or is damaged.
- B. Cards may not meet specifications.
- C. Contrast and/or Intensity may be set to values which are too high.
- D. Dust or embedded contamination on elements of the Print Head.

⇒ **Solution**

- A1. Change ribbon and print again.
- B1. Use a different supply of cards.
- C1. Adjust Contrast and/or Intensity values in software
- D1. Perform a cleaning of the Print Head (see 4.2 Cleaning the Print Head.)

•**Printing shows blurry printed image.**

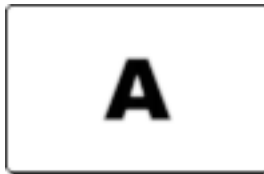

Possible Cause

- A. Ribbon may not be correctly positioned
- B. Ribbon may not be synchronized on the correct color panel position.
- C. Cards may not meet specifications.
- D. Dust inside the printer and/or dirty Cleaning Roller.

⇒ **Solution**

- A1. Open cover and press down the Print Head Unlock Lever to open the Print Head carriage. The Print Head will move up.
- A2. Check ribbon is properly rolled on ribbon cores.
- A3. Push down on the Print Head Lock Lever until an audible «click» signals the locked-down position.
- A4. Ribbon will automatically synchronize.
- A5. Print again.
- B1. Open cover and press down the Print Head Unlock Lever to open the Print Head carriage. The Print Head will move up.
- B2. Push down on the Print Head Lock Lever until an audible «click» signals the locked-down position.
- B3. Ribbon will automatically synchronize.
- B4. Print again.
- C1. Use a different supply of cards.
- D1. Perform a cleaning of the Print Head (see 4.2 Cleaning the Print Head.)
- D2. Replace Cleaning Roller (see 4.3 Cleaning Cartridge.)



•**No printing on the card.**



Possible Cause

- A. Ribbon may not be installed in the printer
- B. Cards may not meet specifications.
- C. Cable on Print Head may be disconnected.
- D. Print Head elements may be scratched or burnt.

⇒ Solution

- A1. Check for ribbon in the printer.
- B1. Use a different supply of cards.
- C1. Power off the printer and check the Print Head cable connections.
- D1. Call Service for Print Head replacement information.



For optimum print quality, always keep cover of the printer closed except during ribbon loading and card thickness control procedures.

The card flipper will not operate and an error will be indicated if you try to flip a card with the cover open.

TECHNICAL SPECIFICATIONS

General

- Speed: print over 102 r/s our to null color YM KOK t rou put
- Small footprint
- Windows r v r s or 95 98 n NT 4 0 option
- On y r print r w r r nty
- On y r print w r r nty

Colour Printing

- Color: full color or mono color
- 35 s on s p r r 2 s s YM KOK t rou put
- 300 p 118 dots/mm print resolution
- to print station

Fonts

- Resident: 100 r l ol 100
- True Type fonts v l l v Windows r v r

Cards*

- Types: PV compost
- r w t l n t : SO R 80 SO 7810 2 125" 54mm y 3 375" 86mm
- Option: M n t Strp SO 7811
- Option: Sm rt r SO 7816 2
- r t kn ss: 0 25mm to 1 524mm
- r r p ty: up to 300 r s 10ml up to 100 r s 30 ml
- r Output opp r p ty: 300 r s 10ml up to 100 r s 30 ml



CARD DIMENSIONS

ISO STANDARD DIMENSIONS FOR PLAIN CARD

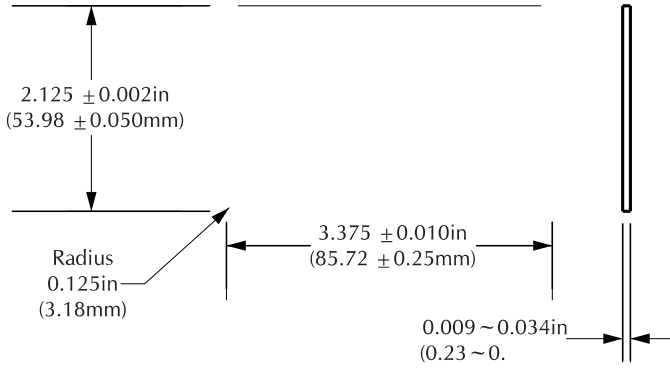

ISO STANDARD DIMENSIONS FOR PLAIN CARD

CHIP POSITION FOR SMART CARD



Ribbons*

- Mono rom : 1500 r s roll
- Mono rom colors: l k r lu r n
y llow slv r ol w t
- K r s n O: 800 r s roll
- K y O: 800 r s roll
- YM KO: 350 r s roll
- YM KOK: 250 r s roll

Overlay Varnish

- T m l tr ns r
- 4 m rons t k
- l r n olo r p opt ons:
l r
nu n S ur olo r m
ustom olo r m

Interfaces

- ntron s P r ll l St n r
- RS 232 S r l Opt on l
- US port Opt on l

Mechanical

- W t : 20 9" 523 mm
- pt : 10 17" 254 3 mm
- t: 10 76" 269 mm
- W t: 27 5 s 12 5 k

Electrical

- 110 ~ 230 Volts 60 ~ 50 z
- l ss UL n UL pprov

Environmental

- Op r tn T mp r tur : 60 to 86° 15 to 30°
- Op r tn um ty: 20 to 65% non on ns n
- Stor T mp r tur : 23 to 158° 5 to 70°
- Stor um ty: 20 to 70% non on ns n
- V ntl ton: r r

T m l tr ns r R sn r ons o r mor ur l ty t n
y su l m ton wt r t r r s st n to s r t s n
UV n u n

y Su l m ton pr nt n r qur s y su l m ton
r ons wt t r l kor y n m nt n y l low
plus l k r s n p n ls

M sur wt out r output opp r



Options

- Intron serial
- RS 232 serial port
- US port
- Smart printer front Station 0.76mm r/s only
- Mounting for 0.76mm r/s only
- Line supplies
- Service Manual



*Use only Polaroid-approved card and ribbon media. Using non-approved card or ribbon media can void your warranty.

Refer to the Accessories section for more information about Card and Ribbon Media available from Polaroid.

APPENDIX A



Magnetic Card Stripe Encoder

This document contains information on the operation of the P100 Printer with Magnetic Stripe Encoder. See page 2 for location.

INTRODUCTION

Operation and maintenance requirements for the P100 Printer with the optional magnetic stripe encoder. See page 2 for location. The magnetic encoder is stored in the low priority



A. MEDIA LOADING ORIENTATION

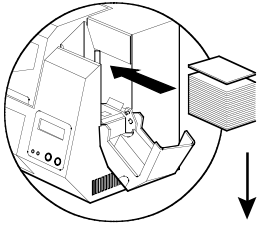

The magnetic encoder is a factory installed item with the read/write head positioned below the card path, available with HICO encoding or LOCO encoding .

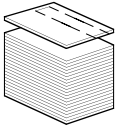

STRIPE
DOWN

← When loading cards into the Card Cartridge, please ensure that the magnetic stripe is facing down and closest to the rear.

Also available are Printer models with the Magnetic Read/Write head positioned above the card path, with HICO encoding or LOCO encoding .

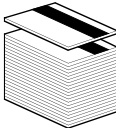

STRIPE
UP

← When loading cards, please ensure that the magnetic stripe is facing up and closest to the rear.

NOT :

M1 = Str p

own O

M3 = Str p up O

M2 = Str p

own LO O

M4 = Str p up LO O

pprov

O

LO OPV

r s r

v l l

S

pp n x



ONLY US r st t omply wt SO 7810

7811 st n r s or m n t str p r s

T m n t str p must lus to t

sur o t r to work prop rly N v r

us t p on m n t str p s

B. MAGNETIC ENCODER CLEANING

This section describes two different processes to clean the Magnetic Strip on the Transport Rollers. The most important parts to print are the Magnetic Strip rollers to print 4" line or more instructions.

This section describes how to clean the Magnetic Strip rollers. To test the Magnetic Strip rollers, follow:

1. Leave power on.
2. Remove cards from the Card Feeder
3. Insert one Pre-Saturated Cleaning Card (provided) through slot on the side of the Card Cartridge.
4. Press the Menu button until the LCD screen shows CLEANING MENU.
5. Press the Select button to select.
6. Press the Menu button again until the LCD screen shows CLEAN MAG HEAD.
7. Run this operation by pressing the Select button.

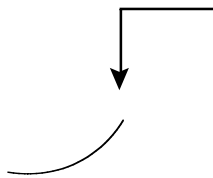

ISO STANDARD ENCODING

Track #	Symbol	Track Sensitivity	Vertical Retention	Number of Retention
1	^	210 P*	lp number S 20~95†	79‡
2	=	75 P*	Number S 48~62	40‡
3	=	210 P*	Number S 48~62	107‡
<p>* typical</p> <p>† expected retention</p> <p>‡ minimum Start Stop LR retention. Also not to test 3 retention. Automatically maintainment or not to SO Standard Norms</p> <p>NOT: Retention Print Program Manual or optional programming norm</p>				



APPENDIX B



Smart Card Contact Station

This station contains information on the operation of the P100 Printer with Smart Card Contact Station. See Chapter 2 for more information.

INTRODUCTION

Smart Cards are used in many computer networks for Memory Storage and reports. For information on the printer's memory, see the T P100 manual. The printer is optional for the printer or program. Smart Cards SO 7816. This printer model responds to common standard protocols. For information on the printer's connection to the Smart Card, see all of the printer's operations manual. See the station for P100 model.



A. MEDIA LOADING ORIENTATION

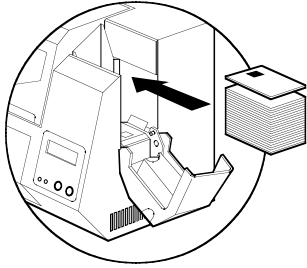

Position the cards with the Smart Card Chip at the top of the card and towards the printer.

B. SMART CARD CONTACT STATION INTERFACE

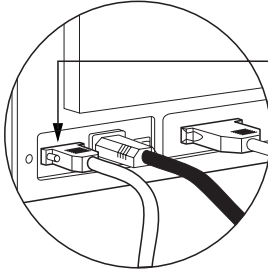

When a command to the parallel printer interface sends a card to the Smart Card Contact Station, the printer connects the Smart Card Contact Station to the female DB-9 connector on the rear of the printer.

An attached external Smart Card Programmer can be used to program Smart Card chips.

9 P NS	SM RT R ONT T POINTS	9 P NS	SM RT R ONT T POINTS
1	V	6	6 Vpp
2	2 R s t	7	7 O
3	3 lo k	8	8 R U
4	4 R U	9	N w n p s t st ton
5	5 N		

R r t r Pr nt r Pro r mm r s M nu l or ompl t pro r mm n n orm ton



DO NOT post on prnt n ov r t Sm rt r
p



APPENDIX C

Accessories & supplies

Please contact your Pol ro ut or s l r to pl n or r or ssor s n suppl s

RIBBONS

Follow n r ons m y us n t P100 Prnt r:

Monochrome Resin Ribbons (Sold by the Roll)	
s r pt on	
l k	1000 m s
R	1000 m s
r n	1000 m s
lu	1000 m s
ol	1000 m s
Slv r	1000 m s
W t	1000 m s
S r t O ry	1000 m s
l k	1500 m s
R	1500 m s
r n	1500 m s
lu	1500 m s
Y llow	1500 m s
ol	1500 m s
Slv r	1500 m s
W t	1500 m s

Color Ribbons (Sold by the Roll)	
s r pt on	
6 P n l olor R on YM KOK	170 m s
5 P n l olor R on YM KO	200 m s
2 P n l l k R on K y O	500 m s
2 P n l R sn R on K R sn O	600 m s
6 P n l olor R on YM KOK	250 m s
5 P n l olor R on YM KO	350 m s
2 P n l l k R on K y O	800 m s
2 P n l R sn R on K R sn O	800 m s

Not : Y = Y llow M = M nt = y n K = l k O = Ov rl y



CARDS

Follow the product specifications for the following products: P100 products:

Blank White Cards (sold by the box)			
Description			
Premier Grade PVC			
10 ml	†		5 packages 200
10 ml	†	svk	5 packages 200
30 ml			5 packages 100
30 ml		low or vty M Strip	5 packages 100
30 ml		or vty M Strip	5 packages 100
Premier Plus Grade (PVC composite 60/40)			
30 ml			5 packages 100
30 ml		low or vty M Strip	5 packages 100
30 ml		low or vty M Strip	5 packages 100

Notes:

† 10ml = 0 254mm; 30ml = 0 762mm

‡ 10 ml r s r r omm n or snl s prntn n mono rom only

Many other card types are also available; ask your dealer for more information.



ACCESSORIES

ssor s v l l or P100 Prnt rs pp r low lw ys r r to t
p rt num rw npl n n or r

Printer Supplies
s r pt on
t on l r Output opp r R pl m nt Pr nt Kt

Cleaning Supplies
s r pt on
Pr m r l nn Kt 25 sw s 50 r s sv l nn Roll r Kt s to 5 l nn rtr omplt l nn r Kt ox o 100 r s l nn Sw Kt ox o 25 sw s

