

EG1400

Electric Powerhead Owners Manual



P/N 9476

IMPORTANT SAFETY INSTRUCTIONS

Read These Instructions Before Using This Electric Powerhead

WARNING: To reduce the risk of fire, electrical shock or injury:

- Unplug and disconnect power before servicing.
- Do not use on wet surfaces.
- Do not allow to be used as a toy. Close attention is necessary when used by or near children.
- Use only as described in this manual. Use only manufacturer's recommended attachments.
- Do not use with damaged cord or plug. If appliance is not working as it should, has been dropped, damaged, left outdoors, or dropped into water, return it to an authorized servicing dealer.
- Do not pull or carry by cord, use cord as a handle, close a door on cord, or pull cord around sharp edges or corners. Do not run appliance over cord. Keep cord away from heated surfaces.
- Do not unplug by pulling on cord. To unplug, grasp the plug, not the cord.
- Do not handle system or appliance with wet hands.
- Do not put any object into openings. Do not use with any opening blocked. Keep openings free of dust, lint, hair and anything that may reduce airflow.
- Keep hair, loose clothing, fingers and all parts of body away from openings and moving parts.
- Do not pick up anything that is burning or smoking, such as cigarettes, matches or hot ashes.
- Turn off all controls before unplugging.
- Use extra care when cleaning on stairs.
- Do not use to pick up flammable or combustible liquids such as gasoline or use in areas where they may be present.
- Always turn off this appliance before connecting or disconnecting either hose or motorized nozzle.
- The hose contains electrical wires. Do not use if damaged, cut or punctured. Avoid picking up sharp objects.
- Do not leave vacuum or brush when plugged in. Unplug from outlet when not in use and before servicing.

SAVE THESE INSTRUCTIONS
Intended for Household Use Only

Parts & Features

It is important to know your vacuum cleaner's parts and features to assure its proper and safe use. Review these before using your cleaner.

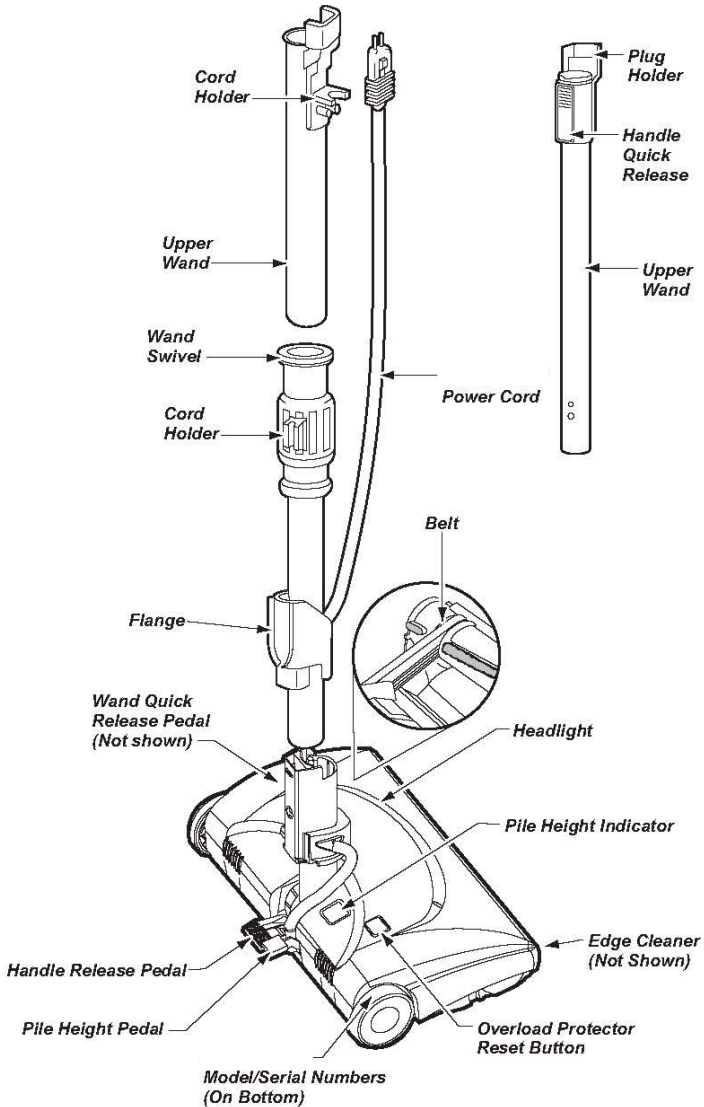

WARNING

Always unplug the EG1400 before cleaning the brush area as brush may suddenly restart. Failure to do so can result in personal injury.

Assembly Instructions

WARNING! Do NOT plug into electrical supply until assembly is complete. Failure to do so could result in electrical shock or injury.

1. Slide wands together until wand button 1 snaps into place. Turn wand button 1 to the slotted area of the wand swivel. (Fig. A) The swivel allows you to turn the handle to the left side to reach under low furniture.

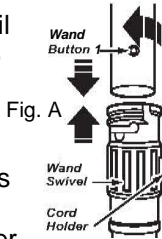

2. Insert connected wands into the EG1400 until the wand button 2 snaps into place.
3. Secure cord into the cord holder on wand swivel.

4. Connect EG1400 plug into the plug holder. (Fig. B) Do NOT force.

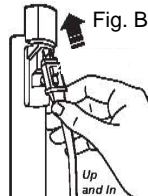

5. Insert the hose handle into the wand until the lock button snaps into place. (Fig. C) Be sure the hose is not twisted. To remove: Press handle release button and pull up on handle.

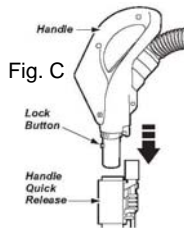

To remove wands: Step on wand quick release pedal, then pull up on wands.

6. Insert the hose wall adapter into the vacuum inlet valve. Plug the 120V cord into the nearest electrical outlet if hose is equipped with a pigtail.

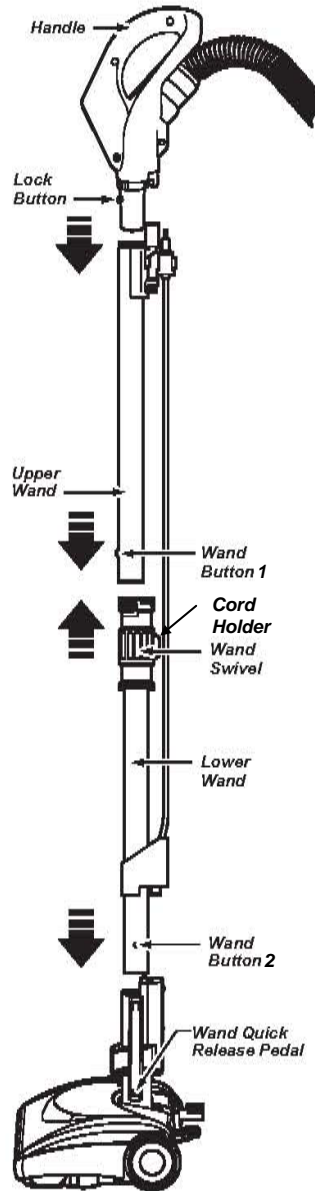

General Operation

- The EG1400 is controlled by the on/off power control switch located on the hose handle. The headlight will operate when the EG1400 is turned on.
- To lower wand from the upright position, simply press on the handle release pedal.
- The powerhead has a pile height pedal for various carpet heights. (Fig. D) Select a pile height setting by pressing the small pedal on the rear of the EG1400. Use the extra low setting for short napped carpets and the high setting for plush carpets.

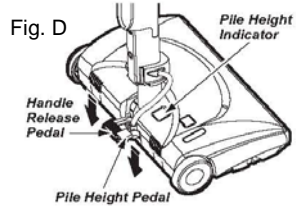

CAUTION: Do NOT leave the EG1400 running in one spot in the upright position for any length of time. Damage to carpet may occur.

Attachments

Using attachments on the hose handle:

1. Press handle quick release button, then pull up on handle. (Fig. E) NOTE: if the EG1400 is attached, turn the powerhead off before removing handle from wands.
2. Slide attachments firmly on hose handle as needed. In some cases, the button may need to be depressed to allow the attachment to slide up higher where it can seal on the metal tube.

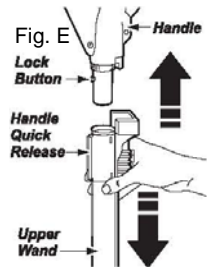

Using attachments on wands:

1. To remove the wands from the EG1400, lock wands in straight-up position. (Fig. F)
2. Press wand quick release pedal with foot and pull straight up out of the EG1400. (Fig. G) The plug and cord do not have to be removed to use attachments on wands.
3. Put attachment on wands as needed. In some cases, the button may need to be depressed to allow the attachment to slide up higher where it can seal on the metal tube.

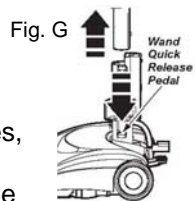
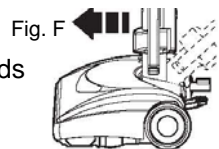

Performance Features

Edge Cleaner

Active brush edge cleaners are on both sides of the EG1400. Guide either side of the EG1400 along baseboards or next to furniture to help remove dirt trapped at carpet edges.

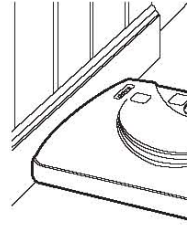

Overload Protector

The EG1400 has built-in protection against motor and belt damage should the agitator jam. If the agitator slows down or stops, the overload protector shuts off the EG1400. The power unit will continue to run. To correct the problem, turn off the power unit, remove obstruction, or press Overload Protector Reset button.



Suction Control

The suction control allows you to change the vacuum suction for different fabric and carpet weights. Opening the control decreases suction for draperies and lightweight rugs, while closing the control increases suction for upholsteries and carpets.



Maintenance and Care

WARNING!!! Disconnect electrical supply before servicing or cleaning the unit. Failure to do so could result in electrical shock or personal injury from cleaner suddenly starting. Always follow all safety precautions specified when caring for your EG1400.

Belt Changing & Agitator Cleaning

Disconnect hose and brush from electrical outlet. Frequently check and remove hair, string and lint buildup in the agitator and support areas. If buildup becomes excessive, disconnect the EG1400 from the wand and follow the steps below.

To Remove Belt

1. Turn EG1400 upside down and unscrew the 2 cover screws. (Fig. H)
2. Turn EG1400 right side up. Press handle release pedal and lower the swivel. Lift rear latches up. (Fig. I)
3. To remove cover, grasp the side and pull out.
4. Depress tabs on rear of agitator cover and rotate forward to release from the EG1400 base. (Fig. J)
5. Lift agitator assembly out and remove worn belt. (Fig. K)
6. Check and clean end cap areas.

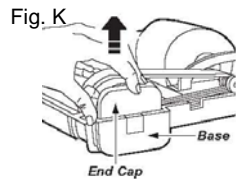
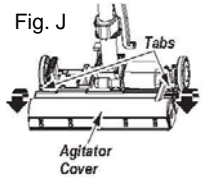
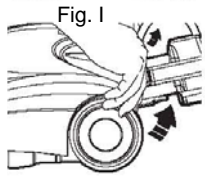
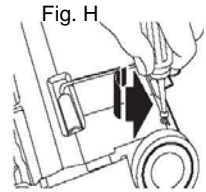

Maintenance and Care

To Replace Belt:

1. Install new belt (Part # 9439-01) over motor drive then over belt path. (Fig. L)
2. Place agitator assembly back into EG1400. (Fig. M)
3. Reinstall agitator cover by lining up the front tabs and slots and rotating downward until the latches snap into place. (Fig. N)
4. Line up front of cover and base. Rest cover on front edge of base as shown. (Fig. O)
5. Rotate cover back. Press cover firmly until side and rear tabs snap into place. (Fig. P)
6. Turn EG1400 upside down and replace 2 cover screws.

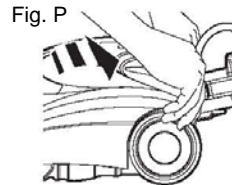
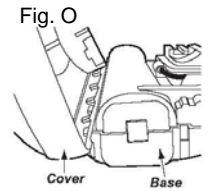
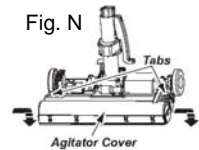
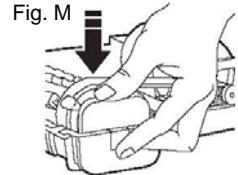
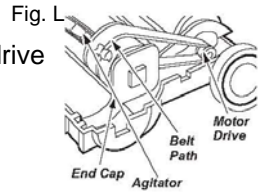

Light Bulb Changing

1. Remove EG1400 cover as shown in Belt Changing & Agitator Cleaning.
2. Push in and turn bulb counterclockwise, then pull out to remove. (Fig. Q)

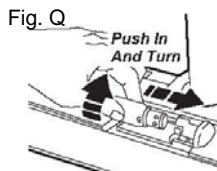

3. Push in and turn bulb clockwise to replace. Bulb must not be higher than 15 Watts (130 Volts). (Fig. R)

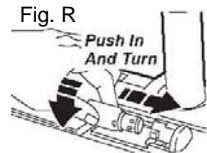

4. Reinstall EG1400 Cover as shown in Belt Changing & Agitator Cleaning.

EG1400 Explosion & Parts List

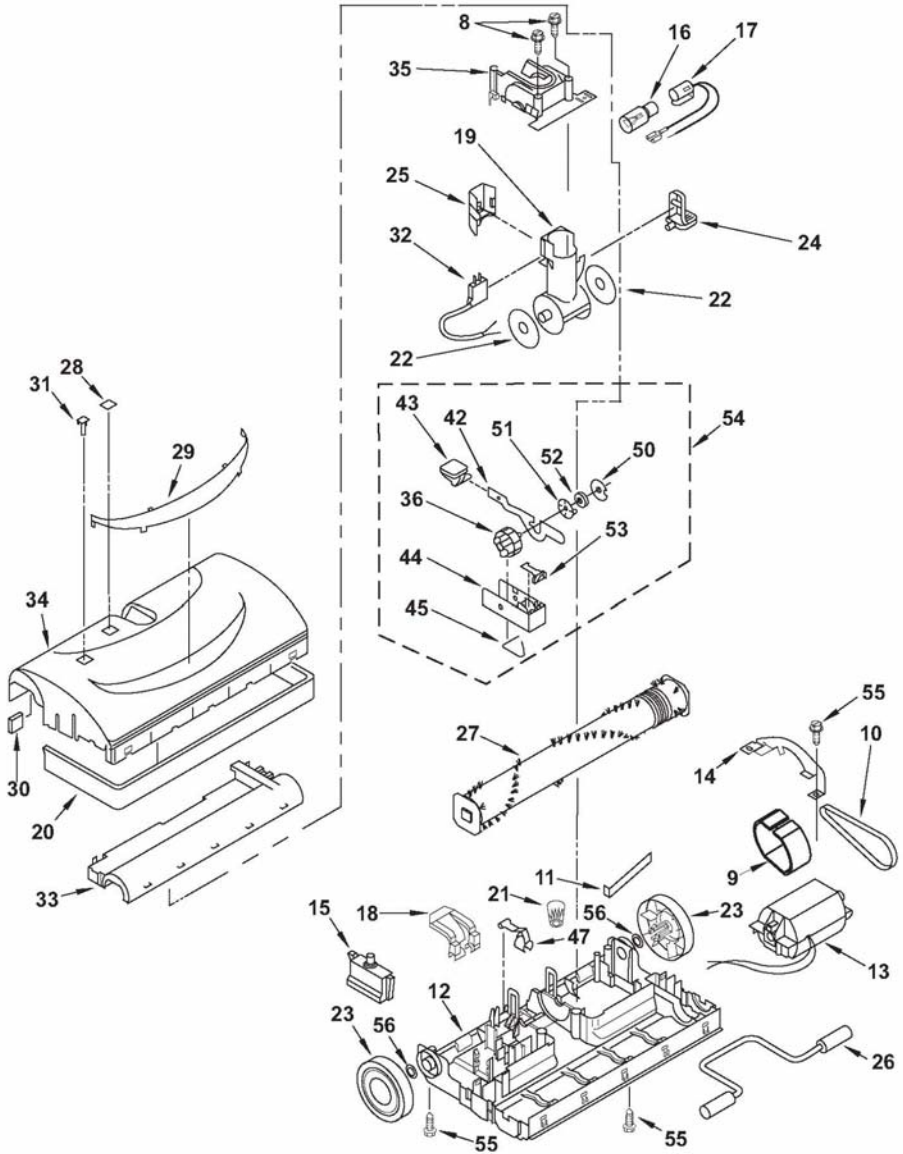

Illustration #	H-P Part #	Description
8	7925	Screw
9	8438	Motor Gasket
10	9439-01	Belt
11	7962	Motor Spring
12	9440	Lower Plate
13	9441	Motor
14	7959	Motor Bridge
15	7941	Overload Protector
16	7967	Light Bulb
17	9442	Bulb Socket
18	7940	Handle Release Pedal
19	7929	Swivel
20	9443	Furniture Guard
21	7966	Wire Connector
22	7930	Swivel Seal
23	9444	Wheel
24	7928	Pedal Quick Release
25	7969	Rear Cover
26	7946	Front Axle Assembly
27	9445	Agitator Unit
28	7963	Indicator Window
29	9446	Window Cover
30	9447	Exhaust Foam
31	9448	Button Extension
32	7972	Lead Wire Unit
33	9449	AGT Cov
34	9450	Nozzle Housing
35	9451	Swivel Cap
36	7933	Cam Indicator
42	7932	Indicator Lever
43	7931	Pad Foot Pedal
44	7934	Indicator Block
45	7935	Spring Assist
47	7939	Lifter
50	7948	Washer Thrust
51	7950	Catch Indexing
52	7949	Washer
53	7951	Ratchet Catch
54	9452	Indicator Block Assembly
55	7958	Screw
56	9453	Bushing

LIMITED WARRANTY

H-P PRODUCTS, INC. warrants that the EG1400 Electric Powerhead, when used for household purposes, pursuant to Seller's instructions, will be free from defects in materials and workmanship for a period of one (1) year from the date of the initial consumer purchase. H-P PRODUCTS, INC. warrants that the EG1400 Electric Powerhead, when used in a commercial application, pursuant to Seller's instructions, will be free from defects in materials and workmanship for a period of ninety (90) days from the date of the initial sale by H-P PRODUCTS, INC. This warranty is limited to the replacement of defective parts and any costs of shipping shall be incurred by the purchaser.

THIS WARRANTY IS EXCLUSIVE AND IS IN LIEU OF ALL OTHER WARRANTIES, EXPRESS, IMPLIED, OR STATUTORY, AND H-P PRODUCTS, INC. SPECIFICALLY DISCLAIMS RESPONSIBILITY FOR CONSEQUENTIAL AND INCIDENTAL DAMAGES, AND LIMITS THE IMPLIED WARRANTY OF MERCHANTABILITY TO THE PERIOD OF EFFECTIVENESS OF THIS EXPRESS WARRANTY.

**H-P Products, Inc.
512 W. Gorgas Street
Louisville, OH 44641
www.centralvacservice.com**