

**INSTALLATION INSTRUCTIONS FOR INSTALLING BLOWER  
KITS FOR USE WITH COUNTRY COLLECTION™ MODELS S160, SA160, SS210,  
ST210, S260 AND ST310 FREESTANDING WOODSTOVES**



**KIT CONTENTS**

- 1 ea. Blower Assembly (item #1)
- 1 ea. Snap Switch and Control Panel Housings (item #2)
- 1 ea. Instruction Sheet

**TOOLS NEEDED**

- 5/32 Allen Wrench Or T Handle Wrench
- 9/16" Socket Wrench
- 9/16" Open End Wrench
- Large Flat Head Screwdriver

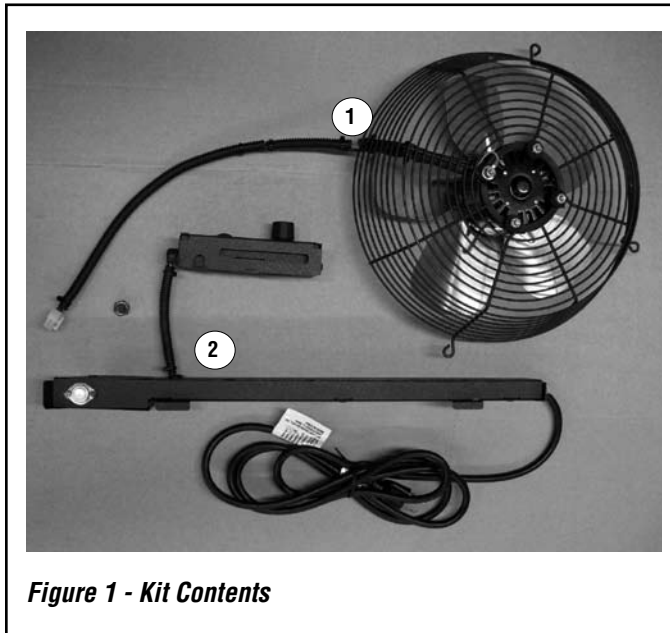


Figure 1 - Kit Contents

THERMALLY ACTIVATED BLOWER KIT		
Cat. No.	Model	Description
H7917	BLWR-FSB700-SS	Blower Kit, FS Woodstoves

**GENERAL INFORMATION**

This optional blower kit can be installed to improve hot air distribution throughout the room. The 700-CFM room air circulation blower kit comes with a variable speed control (rheostat) and an snap switch which will provide automatic thermal activation of the blower, when desired (see *Blower Operation on Page 6*).

If you encounter any problems, need clarification of these instructions or are not qualified to properly install this kit, contact your local distributor or dealer.

Read this instruction sheet in its entirety before beginning the installation.

**ALL WARNINGS AND PRECAUTIONS IN THE INSTALLATION AND OPERATION MANUAL PROVIDED WITH THE APPLIANCE APPLY TO THESE INSTRUCTIONS.**

**SHUT DOWN THE STOVE AND ALLOW IT TO COMPLETELY COOL BEFORE PROCEEDING.**

**⚠ WARNINGS**

**The blower must be plugged directly into a properly grounded three-prong receptacle, 120 VAC, 60 Hz, single phase. Do not cut or remove the grounding prong from this plug. Do not route power cord under or in front of appliance.**

**Installation must be in accordance with National Electrical Code, ANSI/NFPA 70 - latest edition. In Canada, the current CSA C22-1 Canadian Electrical Code - latest edition.**

**DANGER: Disconnect power before servicing blower.**

**In the event that you remove the blower for any reason, make sure a cover plate (available from Lennox Hearth Products) is installed before using the heater. Excessive rear wall temperatures will result if the stove is burned without the cover plate. The cover plate is not necessary if a blower has never been installed because a knock-out will be in place to act as the cover.**

## INSTALLATION INSTRUCTIONS

### Install Blower Assembly

- Step 1.** Remove the contents from the blower kit.
- Step 2.** Using a 5/32" allen wrench/T-handle remove the screws in the round knock-out plate on the back of the stove. Bend the knock-out plate back and forth until it can be removed.
- Step 3.** Using a 5/32" allen wrench/T-handle, remove the four screws and washers from the back of the stove. Next, mount the blower as shown in **Figure 2** and the following instructions; Ensure the wiring harness on the blower cage is at the bottom right when mounted to the back heat shield of the stove. Be aware that the blower wiring harness should be clear of the back of the firebox and blower fan blades. The blower can now be fastened to the back of the heat shield with the four screws and washers that were removed earlier in this step using the 5/32" allen wrench/T-handle. Visually inspect that the blower is centered in large opening on the back of the heatshield. If not centered in the opening the fan blades could make contact with the heatshield making excessive noise. Once everything is correctly in place you can then tighten down all four screws. **Tighten the screws moderately tight but do not over tighten as you may strip the holes out.**

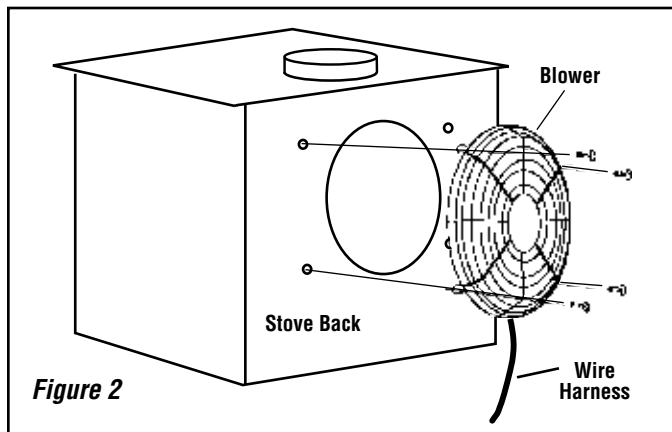


Figure 2

### WOODSTOVES WITH PEDESTAL BASE

Leg based units, see instructions on **Page 4**.

- Step 1.** From rear of stove, using a 9/16" wrench or socket, loosen both left and right pedestal mounting bolts but do not fully remove the bolts from threaded holes as shown in **Figure 3**.

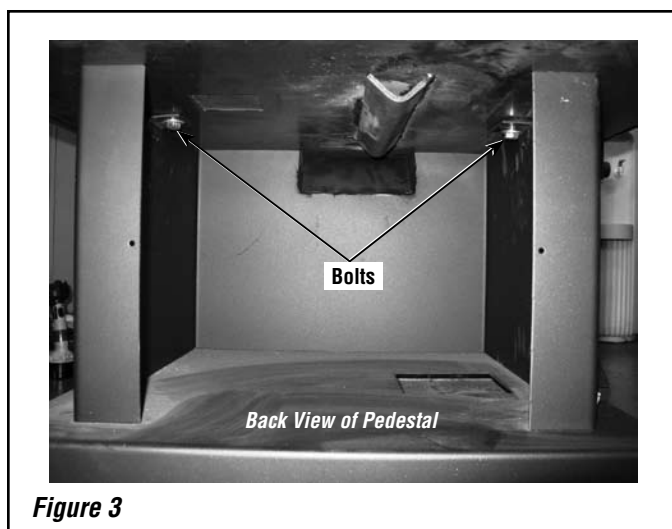


Figure 3

- Step 2.** Insert a large flat head screwdriver or pry bar into the small opening between the pedestal mounting flange and the bottom firebox of the stove. Use the large screwdriver or pry bar to increase the opening size between the firebox bottom and pedestal. **See Figure 4** - This increased opening between the pedestal and bottom firebox will be needed to insert the snap switch bracket mounting tabs.

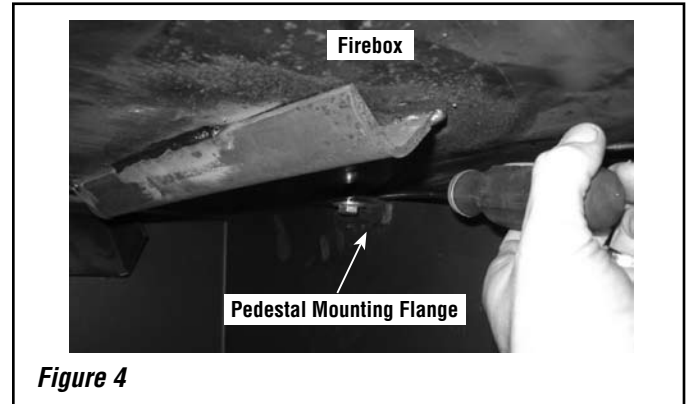


Figure 4

- Step 3.** Insert snap switch bracket mounting tabs between the pedestal and the firebox bottom. **See Figure 5**.

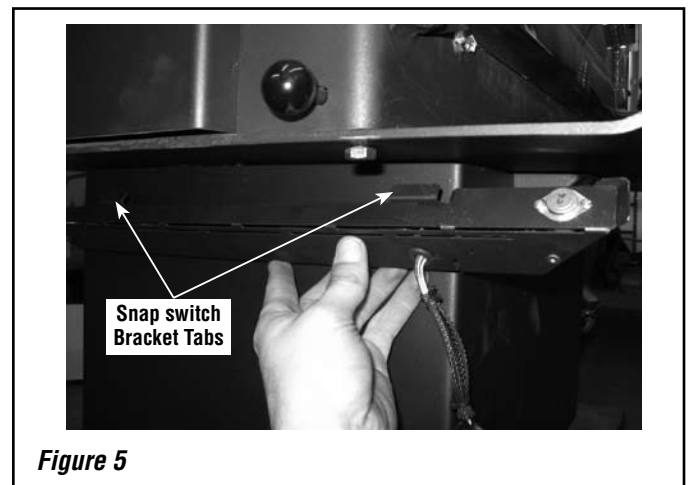


Figure 5

- Step 4.** While holding the snap switch bracket against the pedestal, slide the bracket towards the rear of the stove until it comes to a stop. Once the snap switch bracket is in place you can then remove the flat head screwdriver or pry bar that was used to create the opening between the firebox bottom and pedestal. **See Figure 6**.

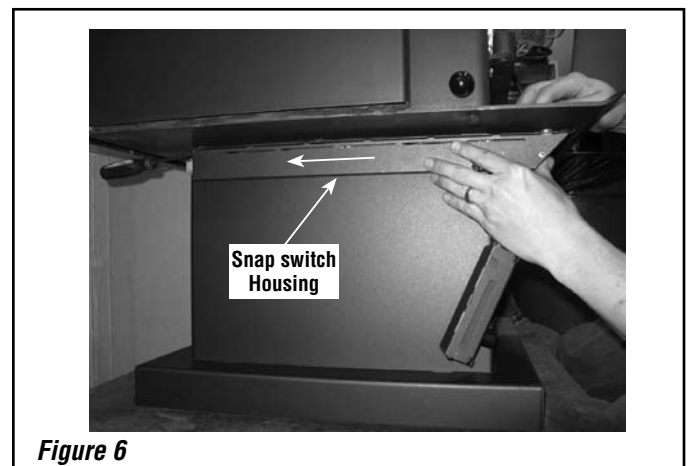
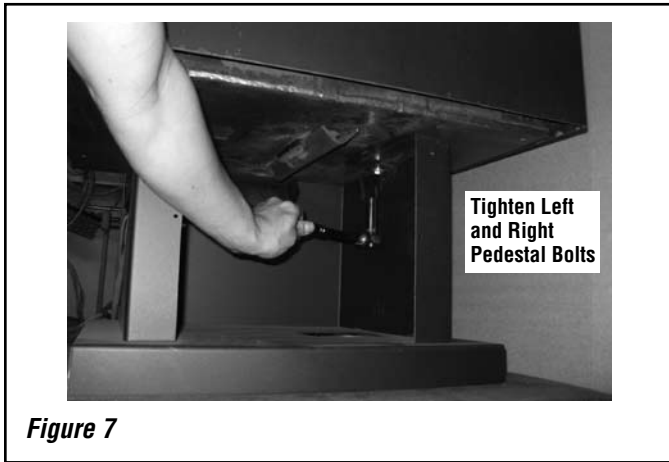


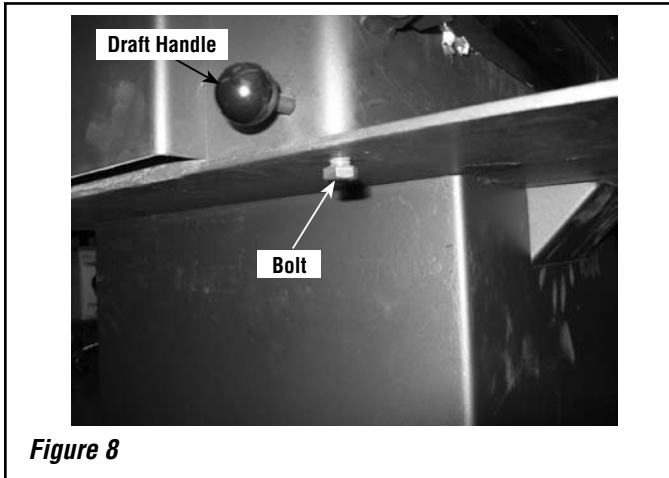
Figure 6

**Step 5.** With the snap switch bracket in place, using a 9/16" wrench or socket wrench you can now tighten down both left and right side pedestal bolts. See **Figure 7**.



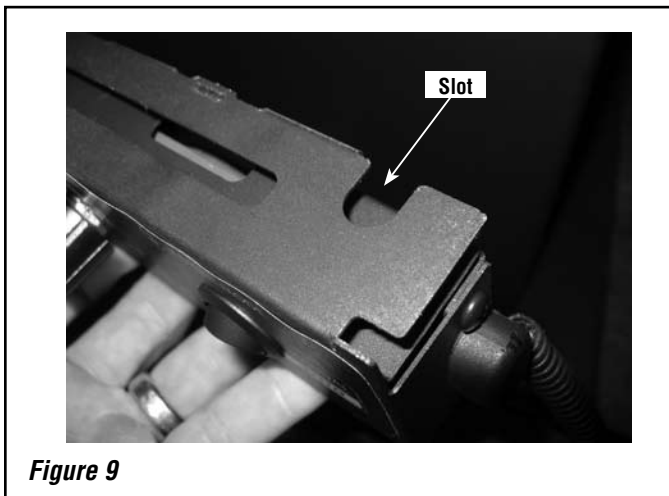
**Figure 7**

**Step 6.** Locate the 3/8" diameter x 1/2" long bolt on the bottom of the firebox near the draft handle. Using a 9/16" wrench or socket loosen this bolt but do not remove from threaded hole. See **Figure 8**. **Note:** This bolt was holding the stoves shipping legs on the stove and should have been reinstalled with the other three bolts that were holding the shipping legs on the stove per the pedestal instructions.



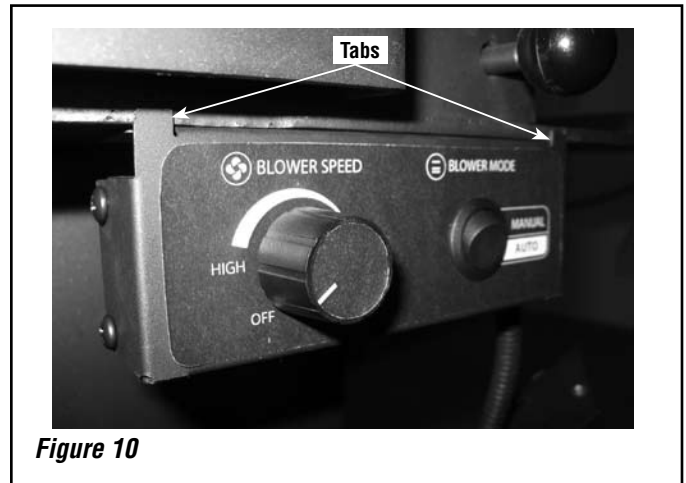
**Figure 8**

**Step 7.** Locate front slot on the Control Box as shown in **Figure 9**.



**Figure 9**

**Step 8.** Install the control box by sliding the front control box slot over the 3/8" bolt head from Step 6. Slide control box towards the center of the stove until it stops on the tabs. See **Figure 10**.



**Figure 10**

**Step 9.** Using a 9/16" open end wrench tighten down the 3/8" bolt holding the control box. See **Figure 11**.



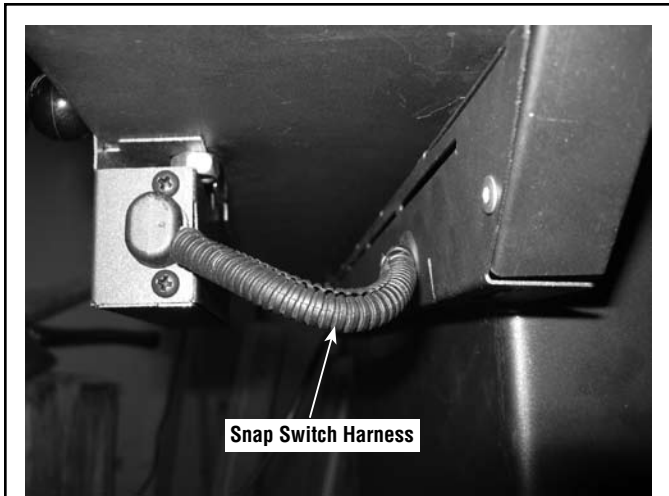
**Figure 11**

**Step 10.** Connect the wire harness from blower to female connector on rear of snap switch bracket. See **Figure 12**.



**Figure 12**

**Step 11.** Visually inspect wires are clear of contact with bottom of firebox. See *Figures 11 through 13.*

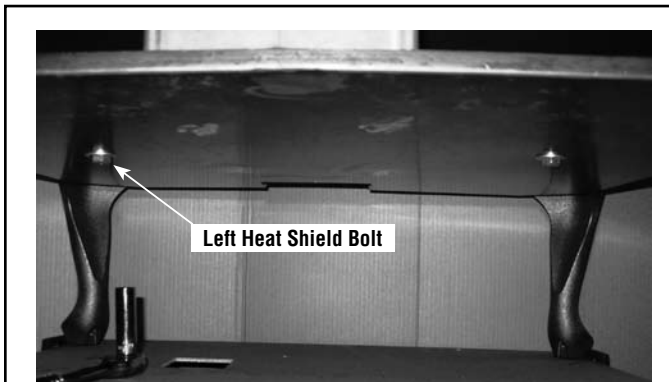


**Figure 13**

**Step 12.** Plug the power cord into a grounded 120 VAC receptacle. Do not route the power cord under the stove or allow it to come in contact with any surface of the stove.

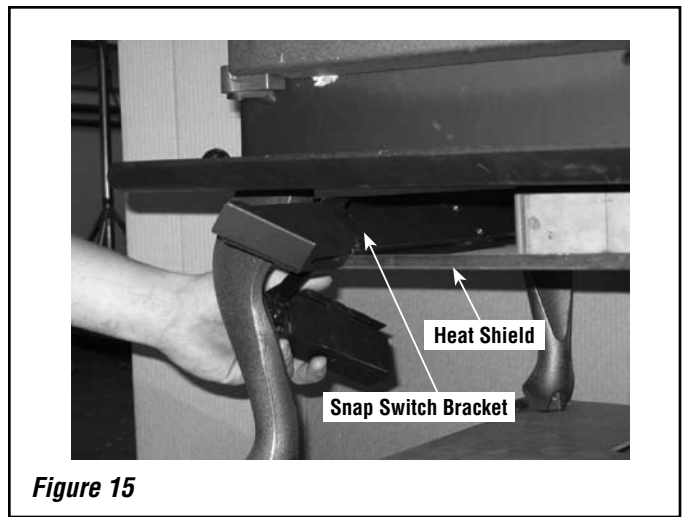
#### WOODSTOVES WITH LEG BASE

**Step 1.** Using a 9/16" wrench or socket loosen the left heat shield bolt. This bolt is located on the bottom side of the leg heatshield as shown. See *Figure 14.*

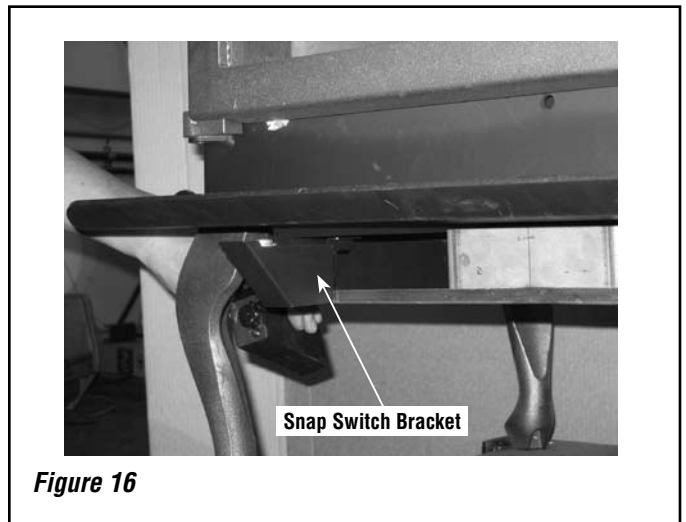


**Figure 14**

**Step 2.** Insert snap switch bracket between the heatshield and the bottom of firebox making sure entire assembly is on the left side of the heatshield bolt. Slide back until the notch on the bottom front of the bracket falls into the lip on the front of the heatshield, and assembly is parallel with side of firebox. See *Figures 15 and 16.*



**Figure 15**

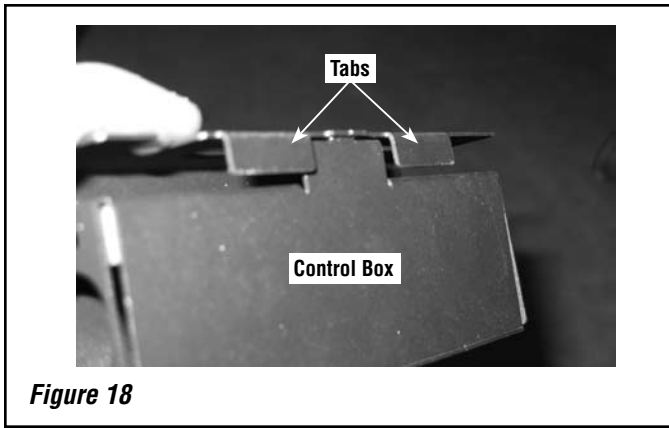


**Figure 16**

**Step 3.** Locate the tabs on the back of the control box. Slide the tabs onto the upper edge of the left side of the heatshield. See *Figures 17 and 18.*

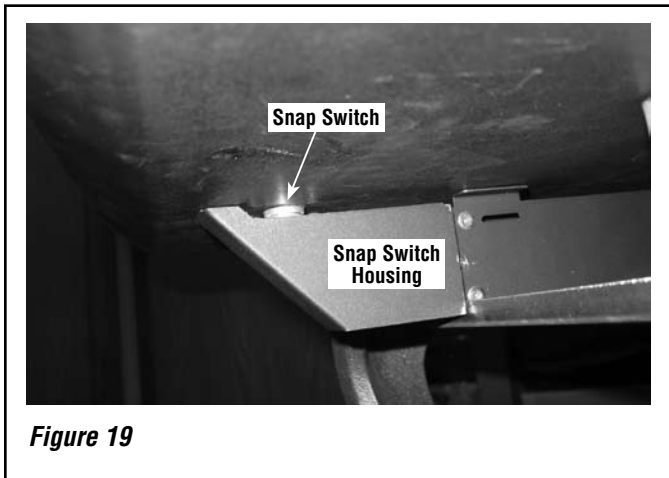


**Figure 17**



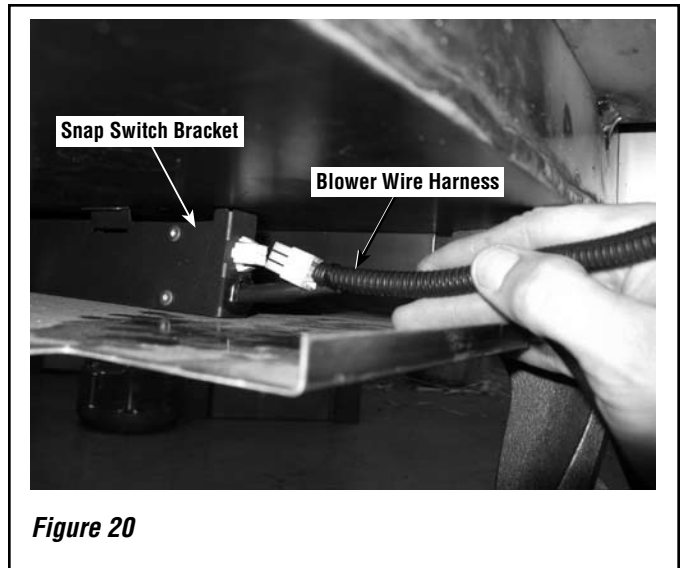
**Figure 18**

**Step 4.** Using a 9/16" wrench, slowly start to tighten the bottom heatshield bolt. While tightening bolt, and before snug, make sure the snap switch housing does not shift. **DO NOT OVERTIGHTEN.** Make sure snap switch is making firm, flat contact with ashlip, and does not shift. See **Figure 19**.



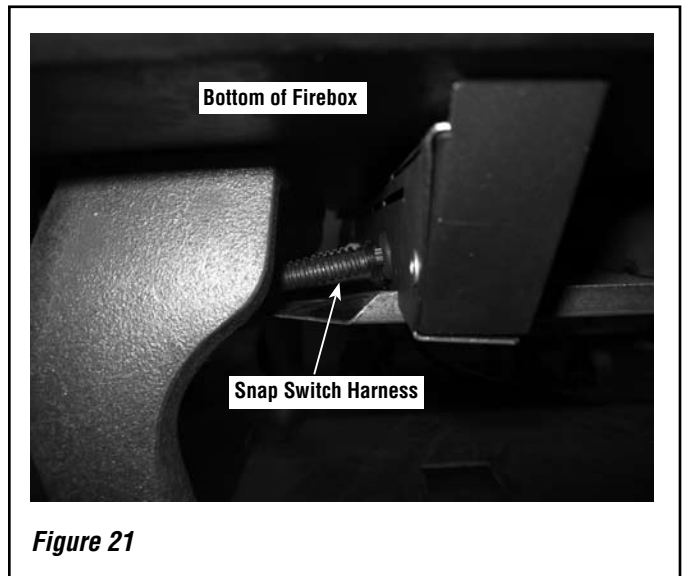
**Figure 19**

**Step 5.** Plug the blower harness into plug on rear of snap switch bracket. See **Figure 20**.



**Figure 20**

**Step 6.** Visually inspect wires are clear of contact with firebox. See **Figures 20 through 21**.



**Figure 21**

**Step 7.** Plug the power cord into grounded 120 VAC receptacle. Do not route the power cord under the stove or allow it to come in contact with any surface of the stove.

## Blower Operation

The blower can be operated manually or automatically (blower will turn on when the stove is hot and turn off when the stove is cool).

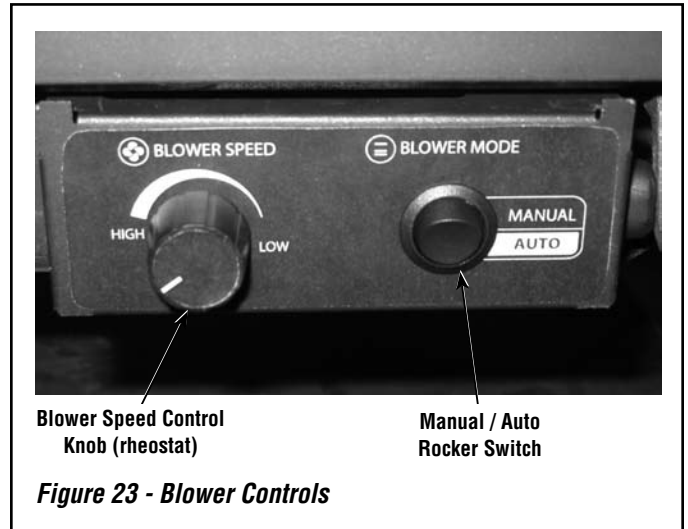
The rocker switch on the control panel allows you to select between manual operation or automatic operation as follows (see **Figure 23**):

— **MANUAL OPERATION:** Turn rocker switch to the “MANUAL” position and adjust rheostat knob to the desired speed. The blower will have to be manually turned “OFF” by rotating the rheostat knob counterclockwise until it clicks.

≡ **AUTO OPERATION:** Turn rocker switch to the “AUTO” position and the rheostat to the ON position (rotate rheostat knob clockwise until it clicks). When the stove warms up, the blower will automatically turn on (adjust rheostat knob to the desired speed setting). When the stove cools down, the blower will automatically turn off.

**Rheostat Operation** - The highest blower speed is obtained by turning the rheostat knob clockwise until it clicks “ON”, then rotate towards “HIGH” to increase blower speed. Rotate the knob clockwise for a lower speed. To turn off, continue to rotate the knob counterclockwise until it clicks “OFF.”

to prevent circulating cool air. Depending on the size and intensity of the fire it may be necessary to adjust the fan speed accordingly to ensure uninterrupted fan operation. For example a small fire may require a slower fan speed to keep the heat output by the fan consistent. If the blower is operated in manual mode, it may be necessary to adjust the blower speed as the fire begins to burn down and the stove is no longer hot enough to effectively heat the air moved by the blower. If the air coming from the blower feels cool, one should either decrease the blower speed or stoke the fire to build up more heat.



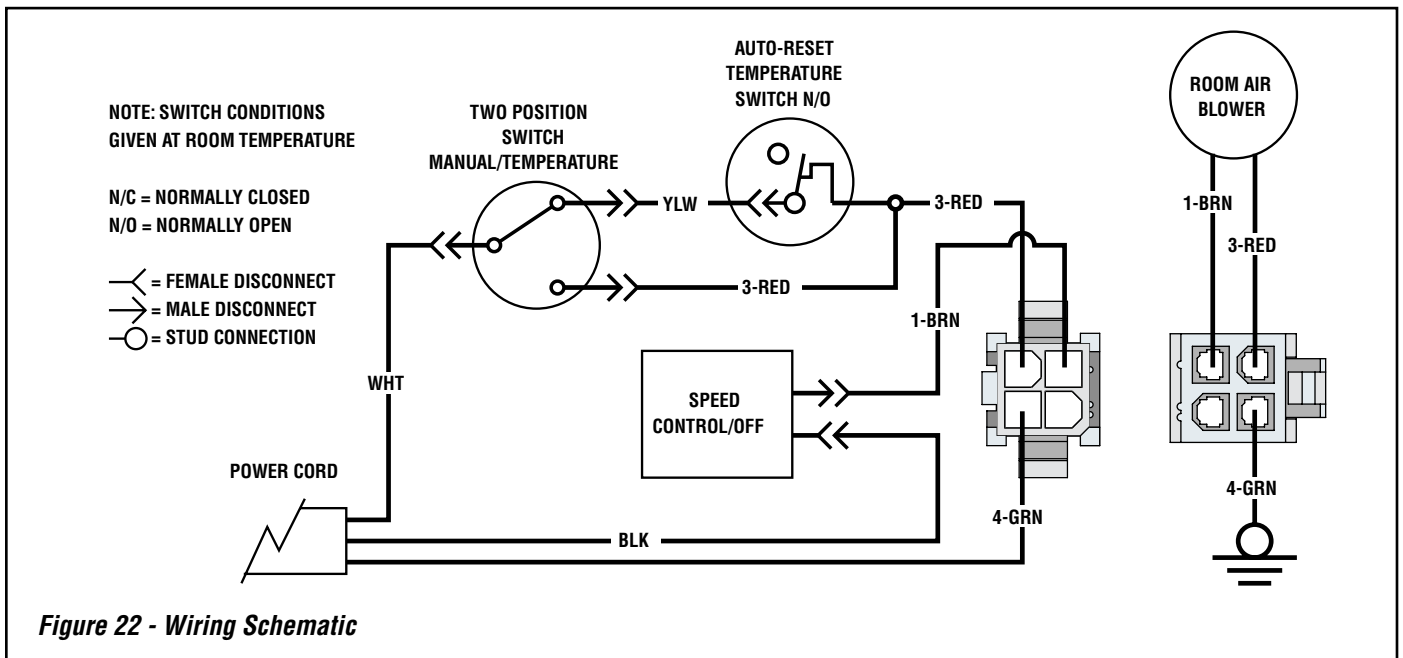
Blower Speed Control Knob (rheostat)

Manual / Auto Rocker Switch

Figure 23 - Blower Controls

## Blower Operation Guidelines

While in auto operation mode, the blower will turn off and on based on the temperature of the stove. Auto operation ensures there is sufficient heat build-up to warm the air being moved by the blower before the blower is turned on. Likewise, when the stove cools off, the blower is turned off



NOTE: DIAGRAMS & ILLUSTRATIONS ARE NOT TO SCALE.

Lennox Hearth Products reserves the right to make changes at any time, without notice, in design, materials, specifications, prices and also to discontinue colors, styles and products. Consult your local distributor for fireplace code information.

**LENNOX**  
HEARTH PRODUCTS