

AOC

LCD Monitor User Manual

Q2963P_M LED backlight



Safety.....	4
National Conventions.....	4
Power	5
Installation.....	6
Cleaning	7
Other.....	8
Setup	9
Contents in Box	9
Setup Base	10
Wall Mounting.....	11
Adjusting Viewing Angle.....	12
Using "MHL(Mobile High-Definition Link)".....	13
Connecting the Monitor.....	14
Daisy Chain	15
Adjusting	16
Setting Optimal Resolution	16
Windows Vista	16
Windows ME/2000.....	17
Windows 8.....	18
Hotkeys.....	20
OSD Setting.....	21
Luminance	22
Image Setup	23
Color Setup.....	24
Picture Boost.....	25
OSD Setup	26
PIP Setting.....	27
Extra	28
LED Indicator.....	29
Driver	30
Monitor Driver	30
Windows 8.....	30
Windows 7.....	34
Windows Vista	37
Windows 2000.....	39
Windows ME.....	39
i-Menu.....	40
e-Saver	41
Screen+	42
Troubleshoot.....	43
Specification.....	45
General Specification.....	45
Preset Display Modes.....	46
Pin Assignments	47
Plug and Play.....	49
Regulation.....	50

FCC Notice	50
WEEE Declaration	51
WEEE Declaration for India	51
EPEAT Declaration	52
Service.....	53
Warranty Statement for Europe.....	53
Warranty Statement for North & South America (excluding Brazil)	55
EASE PROGRAME	57
TCO DOCUMENT	58

Safety

National Conventions

The following subsections describe notational conventions used in this document.

Notes, Cautions, and Warnings

Throughout this guide, blocks of text may be accompanied by an icon and printed in bold type or in italic type. These blocks are notes, cautions, and warnings, and they are used as follows:



NOTE: A NOTE indicates important information that helps you make better use of your computer system.





CAUTION: A CAUTION indicates either potential damage to hardware or loss of data and tells you how to avoid the problem.





WARNING: A WARNING indicates the potential for bodily harm and tells you how to avoid the problem. Some warnings may appear in alternate formats and may be unaccompanied by an icon. In such cases, the specific presentation of the warning is mandated by regulatory authority.

Power

 The monitor should be operated only from the type of power source indicated on the label. If you are not sure of the type of power supplied to your home, consult your dealer or local power company.

 The monitor is equipped with a three-pronged grounded plug, a plug with a third (grounding) pin. This plug will fit only into a grounded power outlet as a safety feature. If your outlet does not accommodate the three-wire plug, have an electrician install the correct outlet, or use an adapter to ground the appliance safely. Do not defeat the safety purpose of the grounded plug.

 Unplug the unit during a lightning storm or when it will not be used for long periods of time. This will protect the monitor from damage due to power surges.

 Do not overload power strips and extension cords. Overloading can result in fire or electric shock.

 To ensure satisfactory operation, use the monitor only with UL listed computers which have appropriate configured receptacles marked between 19V, 3.42A

 The wall socket shall be installed near the equipment and shall be easily accessible.

 For use only with the attached power adapter (Output 19Vdc) which have UL,CSA listed license (Only for monitors with power adapter).

Manufacturers:

- 1) TPV ELECTRONICS(FUJIAN) CO., LTD model: ADPC1965
- 2) SHENZHEN HONOR ELECTRONICS CO., LTD. / model: ADS-65LSI-19-1 19065G

Installation

! Do not place the monitor on an unstable cart, stand, tripod, bracket, or table. If the monitor falls, it can injure a person and cause serious damage to this product. Use only a cart, stand, tripod, bracket, or table recommended by the manufacturer or sold with this product. Follow the manufacturer's instructions when installing the product and use mounting accessories recommended by the manufacturer. A product and cart combination should be moved with care.

! Never push any object into the slot on the monitor cabinet. It could damage circuit parts causing a fire or electric shock. Never spill liquids on the monitor.

! Do not place the front of the product on the floor.

! If you mount the monitor on a wall or shelf, use a mounting kit approved by the manufacturer and follow the kit instructions.

! Leave some space around the monitor as shown below. Otherwise, air-circulation may be inadequate hence overheating may cause a fire or damage to the monitor.

See below the recommended ventilation areas around the monitor when the monitor is installed on the wall or with the stand:

Installed on the wall

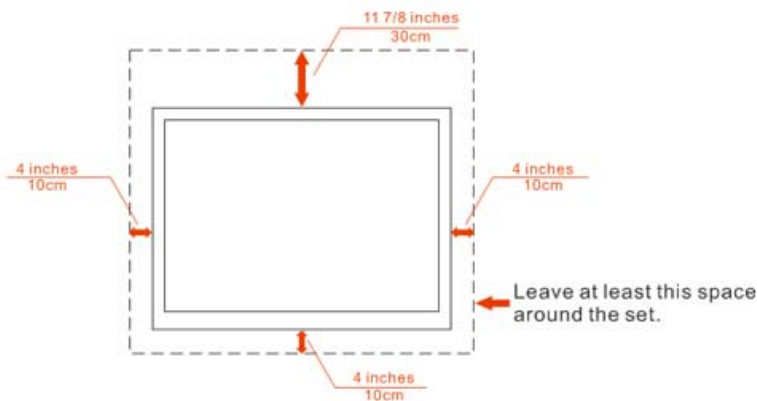

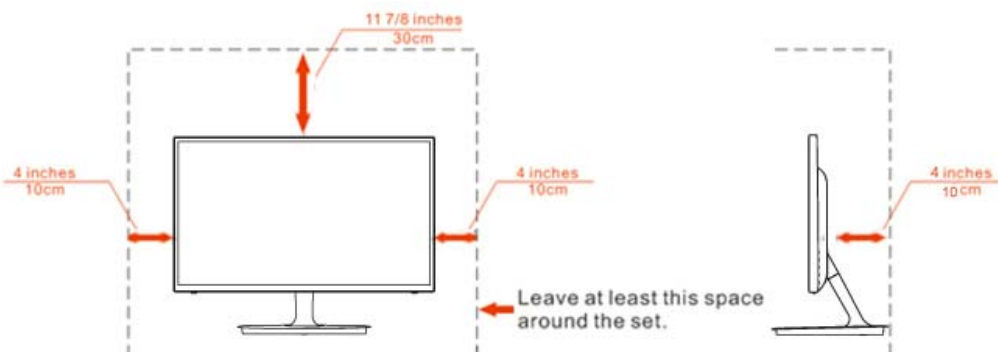

Installed with stand



Cleaning

 Clean the cabinet regularly with cloth. You can use soft-detergent to wipe out the stain, instead of strong-detergent which will cauterize the product cabinet.

 When cleaning, make sure no detergent is leaked into the product. The cleaning cloth should not be too rough as it will scratch the screen surface.

 Please disconnect the power cord before cleaning the product.



Other

 If the product is emitting a strange smell, sound or smoke, disconnect the power plug IMMEDIATELY and contact a Service Center.

 Make sure that the ventilating openings are not blocked by a table or curtain.

 Do not engage the LCD monitor in severe vibration or high impact conditions during operation.

 Do not knock or drop the monitor during operation or transportation.

 For display with glossy bezel the user should consider the placement of the display as the bezel may cause disturbing reflections from surrounding light and bright surfaces.

Setup

Contents in Box

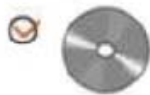
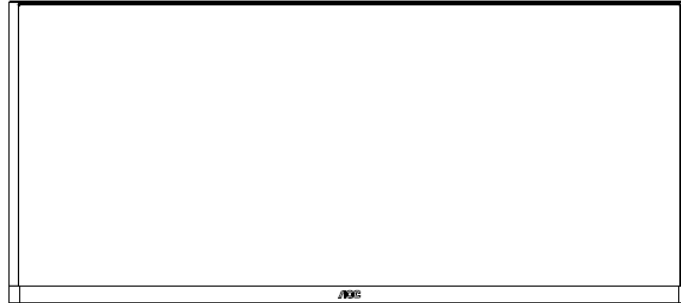

CD Manual



Base



Power Cable



Audio



Dual link DVI



Analog Cable



DP



HDMI



MHL

* Not all signal cables (Audio, Dual link DVI, Analog, DP, HDMI, and MHL cables) will be provided for all countries and regions. Please check with the local dealer or AOC branch office for confirmation.

Setup Base

Please setup or remove the base following the steps as below.

Please place the monitor on a soft and flat surface to prevent the scratch.

Setup:

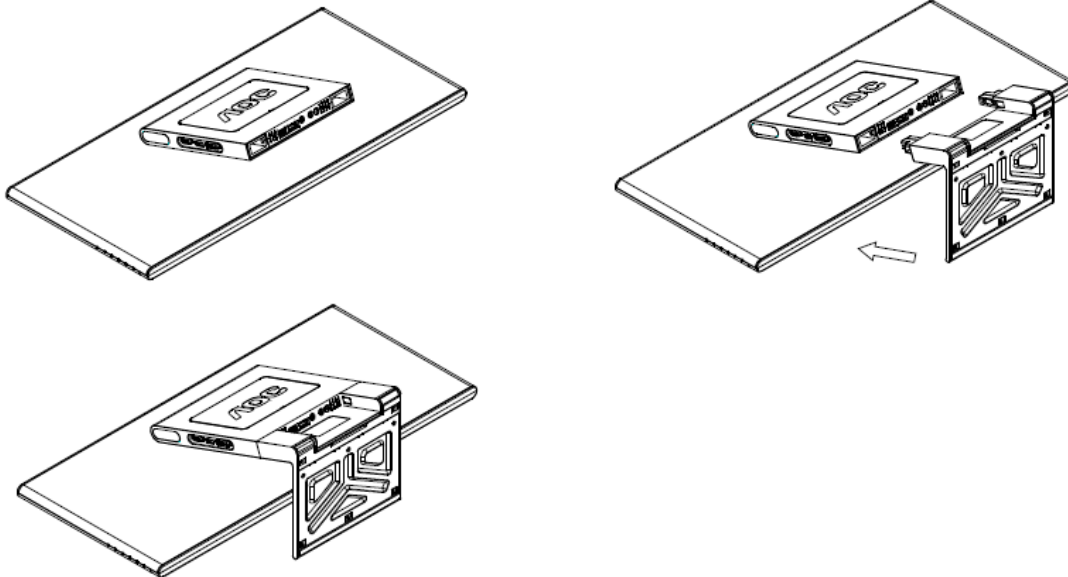

Remove:

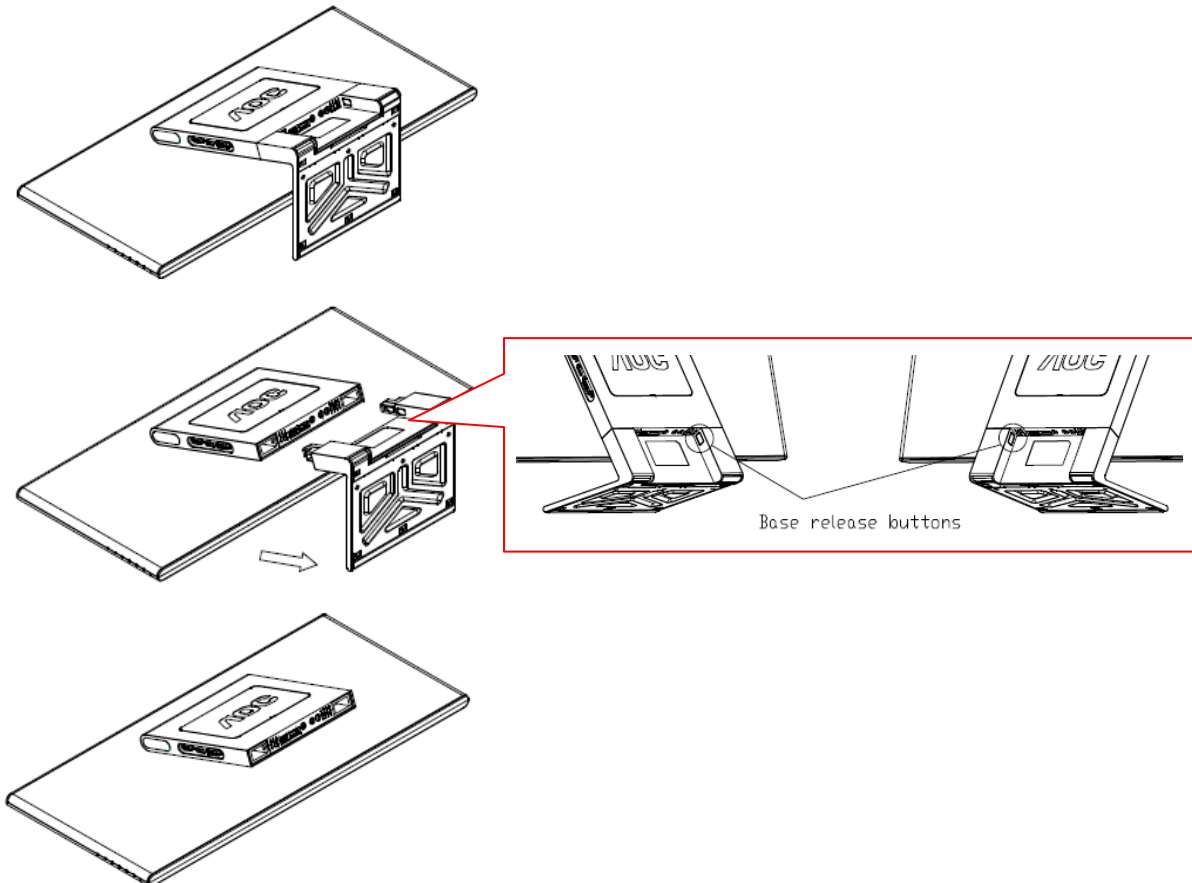

Wall Mounting

Preparing to install an optional wall mount arm.

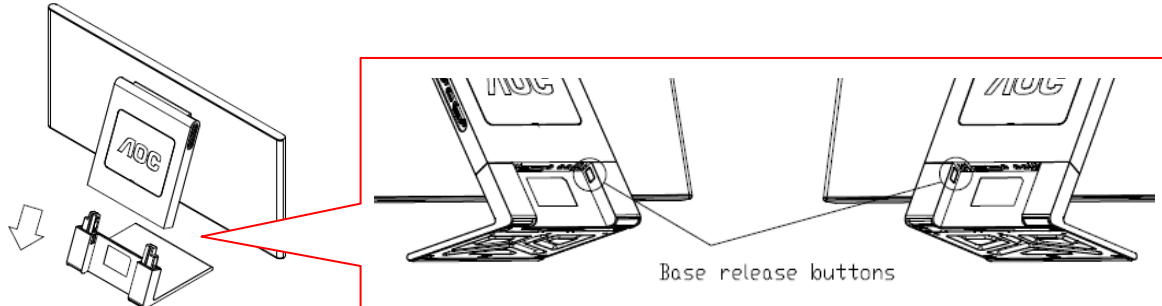

STEP 1

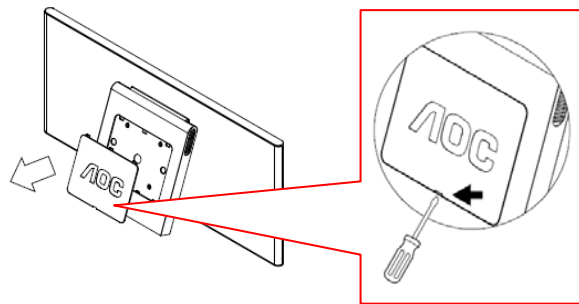

STEP 2

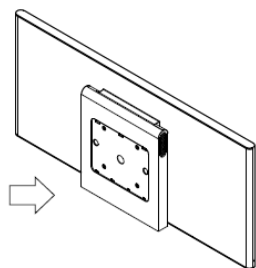

STEP 3

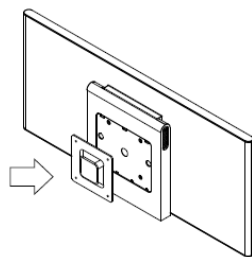

STEP 4



STEP 5

This monitor can be attached to a wall mounting arm you purchase separately. Disconnect power before this procedure. Follow these steps:

1. Press the base release button to remove base.
2. Use flathead screwdriver to remove the VESA cover.
3. Adjust the tilt angle of the neck to parallel with the display.
4. Assemble the wall mounting arm on the back of the neck with 4 screws.
5. Reconnect the cables. Refer to the user's manual that came with the optional wall mounting arm for instructions on attaching it to the wall.

Noted: VESA mounting screws holes are not available for all models. Please check with the dealer or official department of AOC. Before mounting the monitor on the wall, please find the correct length and size of the screw in order to avoid the damage of the monitor. The monitor mounting holes shall support 4 mm, 0.7 pitch, and 10 mm in length screws.

Adjusting Viewing Angle

For optimal viewing, it is recommended to look at the full face of the monitor, and then adjust the monitor's angle to your own preference.

Hold the stand so you will not topple the monitor when you change the monitor's angle.

You are able to adjust the monitor's angle from -5° to 20° .

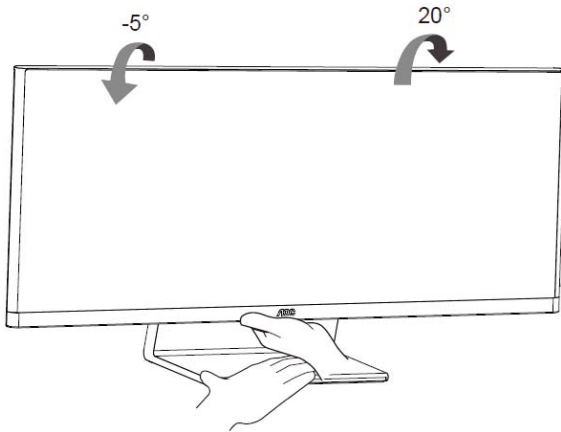

NOTE:

Do not touch the LCD screen when you change the angle. It may cause damage or break the LCD screen.

Using "MHL(Mobile High-Definition Link)"

1."MHL" (Mobile High-Definition Link)

This feature allows you to enjoy videos and photos (imported from a connected mobile device that supports MHL) on the screen of the product.

- To use the MHL function, you need an MHL-certified mobile device. You can check if your mobile device is MHL certified on the device manufacturer's website. To find a list of MHL-certified devices, visit the official MHL website (<http://www.mhlconsortium.org>).
- To use the MHL function, the latest version of software must be installed on the mobile device.
- On some mobile devices, the MHL function may not be available depending on the device's performance or functionality.
- Since the display size of the product is larger than those of mobile devices, the picture quality may degrade.
- This product is officially MHL-certified. If you encounter any problem when using the MHL function, please contact the manufacturer of the mobile device.
- The picture quality may degrade when content (imported from the mobile device) with a low Resolution is played on the product.

Using "MHL"

1. Connect the micro USB port on the mobile device to the [HDMI / MHL] port on the product using the MHL cable.

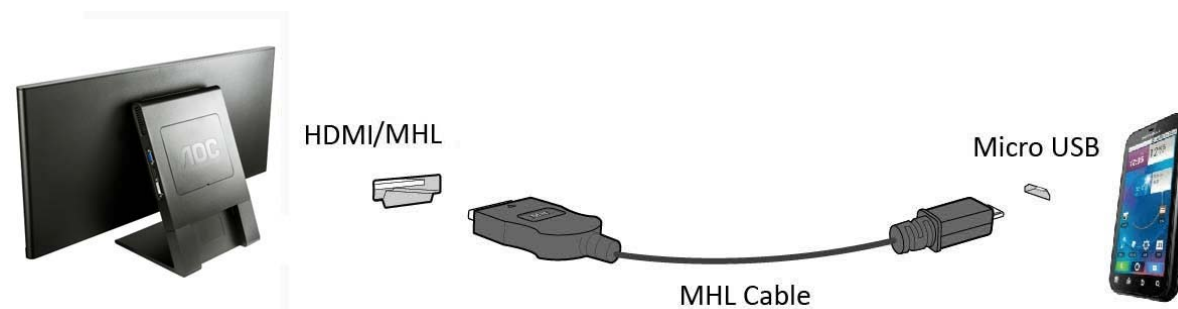

- When the MHL cable is used, [HDMI / MHL] is the only port on this monitor that supports the MHL function.
 - Mobile device must be purchased separately.
2. Connect the DC power adapter to the product and a power outlet.
 3. Press the source button  and switch to HDMI /MHL to activate MHL mode.
 4. After about 3 seconds, the MHL screen will be displayed if MHL mode is active.

Remark: The indicated time "3 sec later" may vary depending on the mobile device.

When the mobile device is not connected or does not support MHL

- If MHL mode is not activated, check the connection of the mobile device.
- If MHL mode is not activated, check if the mobile device supports MHL.
- If MHL mode is not activated even though the mobile device supports MHL, update the firmware of the mobile device to the latest version.

Connecting the Monitor

Cable Connections In Back of Monitor and Computer:

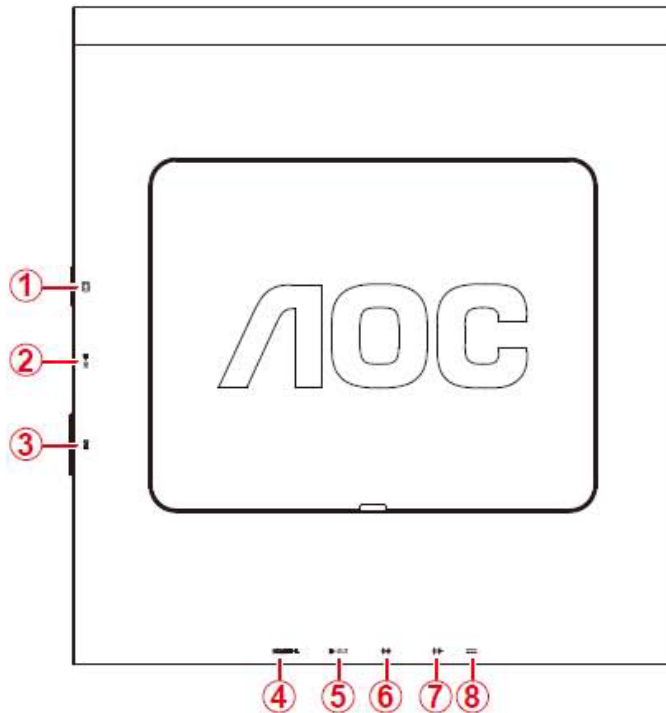

- 1 D-SUB
- 2 DP-IN
- 3 DVI
- 4 HDMI/MHL
- 5 DP-OUT
- 6 Line in
- 7 Earphone out
- 8 DC in

To protect equipment, always turn off the PC and LCD monitor before connecting.

- 1 Connect the power cable to the AC port on the back of the monitor.
- 2 Connect one end of the 15-pin D-Sub cable to the back of the monitor and connect the other end to the computer's D-Sub port.
- 3 Optional – (Requires a video card with DVI port) – Connect one end of the DVI cable to the back of the monitor and connect the other end to the computer's DVI port.
- 4 Optional – (Requires a video card with HDMI port) – Connect one end of the HDMI cable to the back of the monitor and connect the other end to the computer's HDMI port.
- 5 Optional – (Requires a video card with DP port) – Connect one end of the DP cable to the back of the monitor and connect the other end to the computer's DP port.
- 6 Turn on your monitor and computer.
- 7 Video content supporting resolution: VGA / DVI / HDMI / DP: 2560 x 1080/60Hz (Maximum)

If your monitor displays an image, installation is complete. If it does not display an image, please refer Troubleshooting.

Daisy Chain

You can interconnect multiple displays to create a daisy-chain configuration.

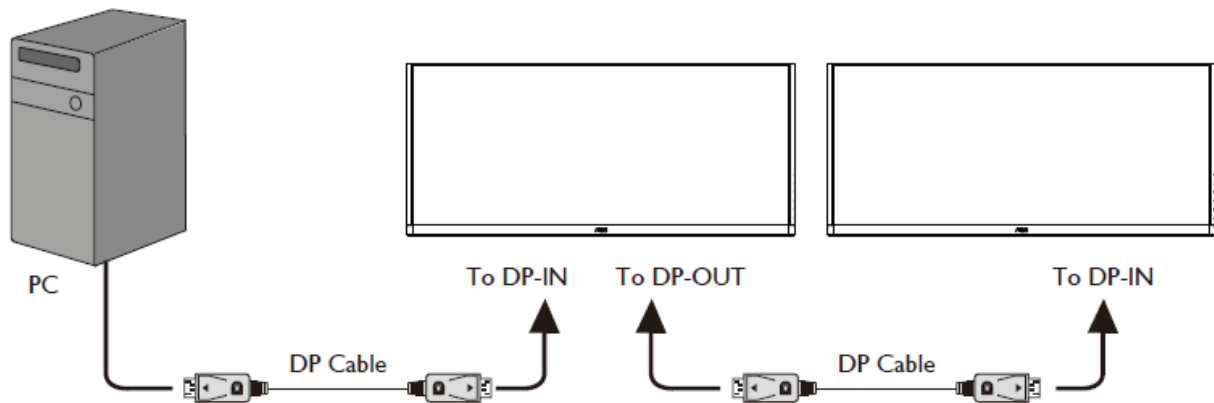

1. For different input video content and max resolution (2560x1080@60Hz): Connecting up to 3 AOC Q2963PM monitors with DP1.2 MST (Multi-Stream Transport) cable.
- Supporting resolution:
 - 1) VGA: 2560 x 1080@60Hz
 - 2) DVI: 2560 x 1080@60Hz (with Dual link DVI cable)
 - 3) HDMI 1.3 & HDMI 1.4: 2560 x 1080@60Hz (recommend with HDMI 1.4)
 - 4) DP1.1 & DP1.2: 2560 x 1080@60Hz (recommend with DP1.2)

Adjusting

Setting Optimal Resolution

Windows Vista

For Windows Vista:

1. Click **START**.
2. Click **CONTROL PANEL**.



3. Click **Appearance and Personalization**.



4. Click **Personalization**



5. Click **Display Settings**.



6. Set the resolution **SLIDE-BAR** to 1920x1080 or 2560x1080.



Windows ME/2000

For Windows ME/2000:

1. Click **START**.
2. Click **SETTINGS**.
3. Click **CONTROL PANEL**.
4. Double click **DISPLAY**.
5. Click **SETTINGS**.
6. Set the resolution **SLIDE-BAR** to 1920x1080 or 2560x1080.

Windows 8

For Windows 8:

1. Right click and click **All apps** at the bottom-right of the screen.

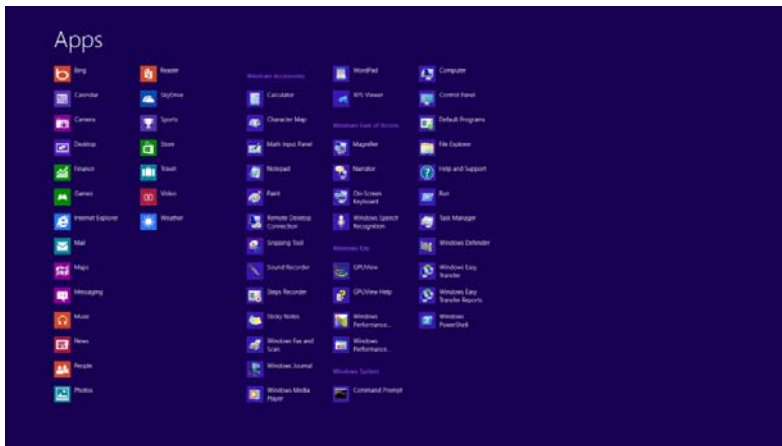
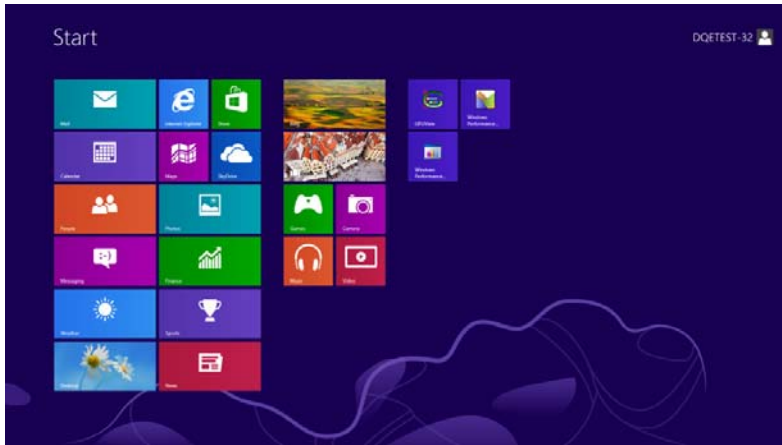

2. Set the "View by" to "Category".
3. Click **Appearance and Personalization**.

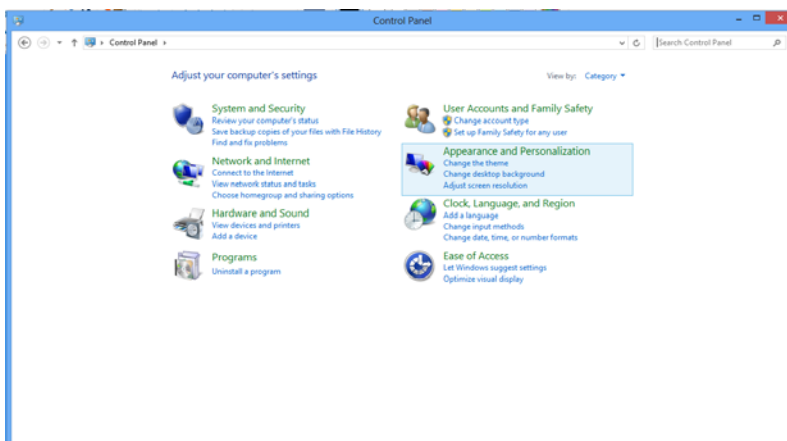

4. Click **DISPLAY**.

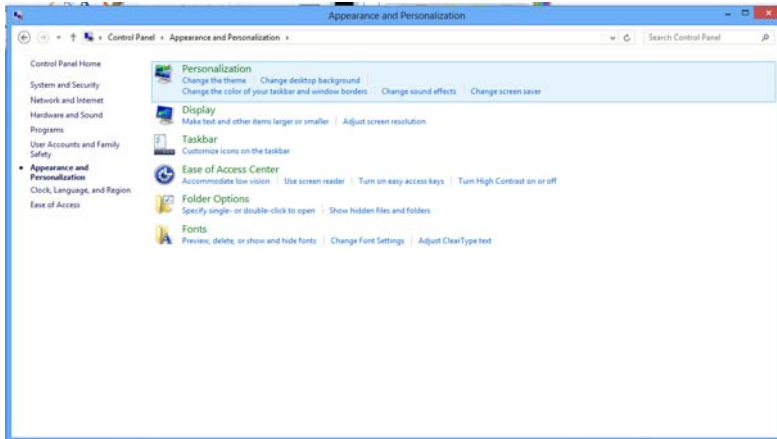

5. Set the resolution **SLIDE-BAR** to 1920x1080 or 2560x1080.

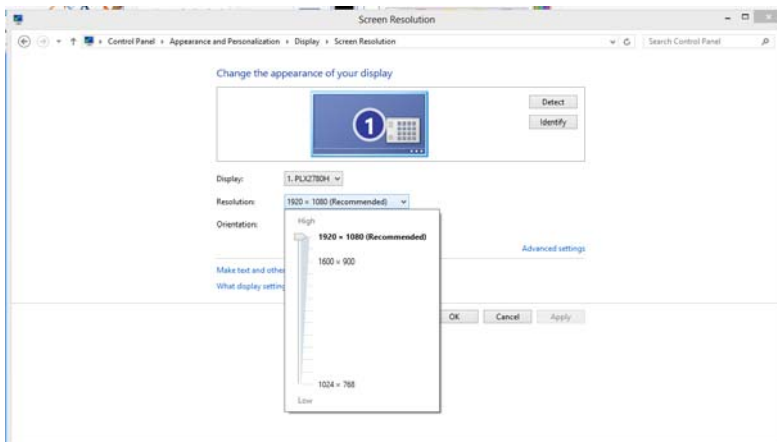

Hotkeys

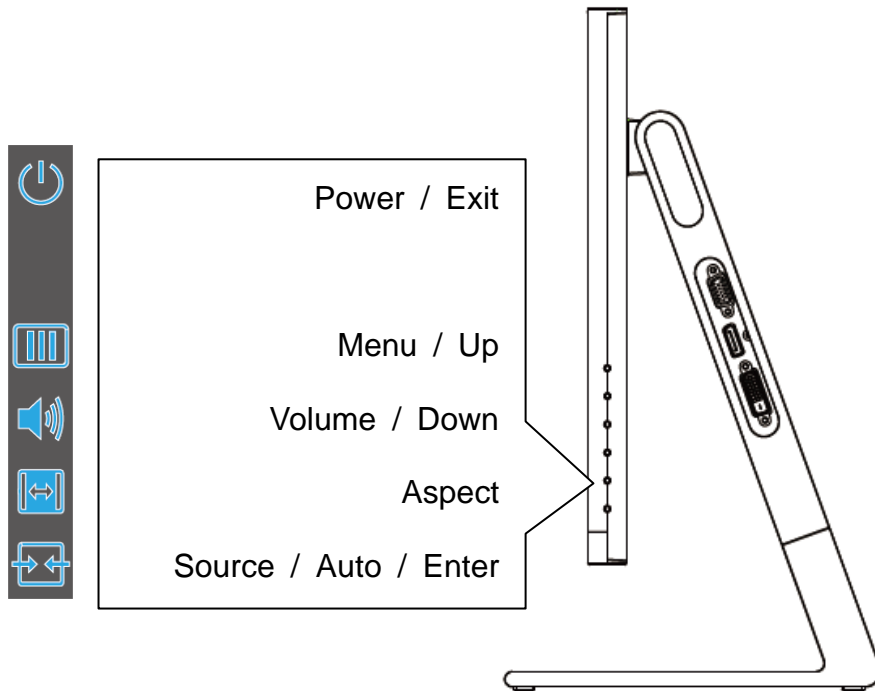

Press any key to display the control menu.

Power / Exit

Press the Power button to turn on/off the monitor.

Menu / \wedge

Press to display the OSD.

Volume / ∇

Press to adjust the volume.

Aspect / \leftarrow

Press to show Image Ratio list to change 21 : 9, 16 : 9, 16 : 10, 4 : 3, 1 : 1 ratio. (If the product screen size is 4:3 or input signal resolution is native resolution, the hot key is disabled to adjust.)

Source / Auto / Enter / \rightarrow









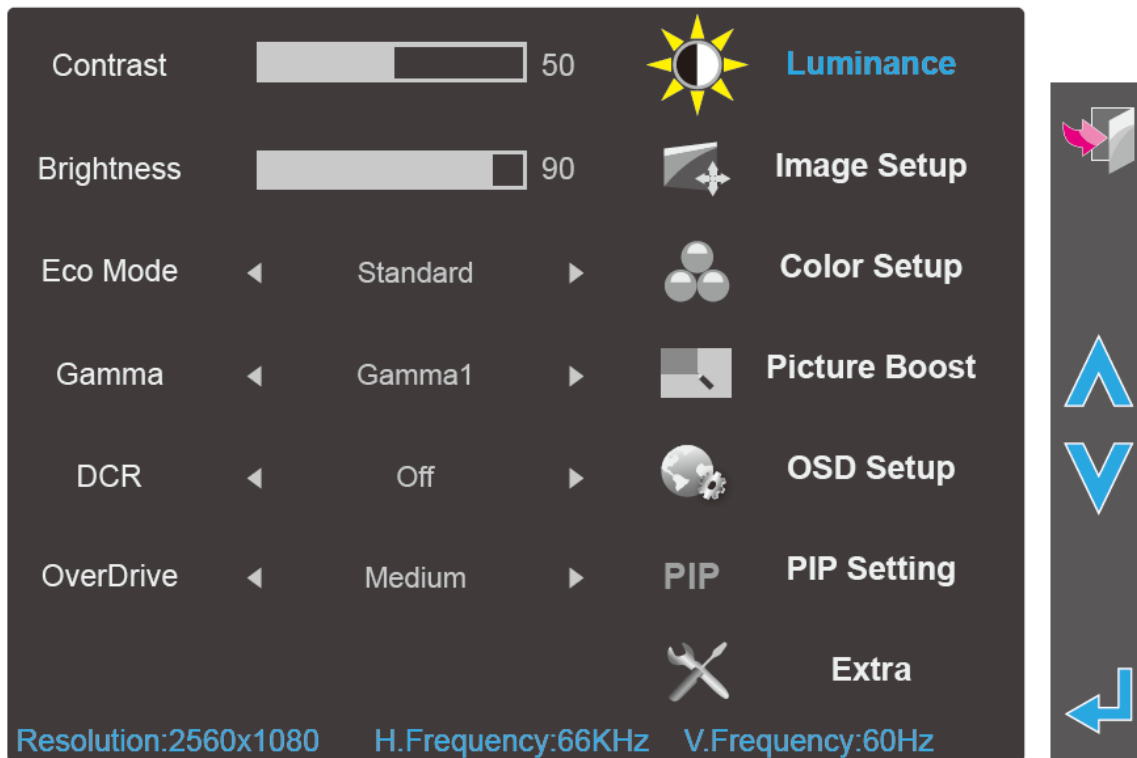



Press to show Source and PIP function list to select the video content or PIP function.

Press about 2 seconds to do auto configure (only for the models with dual or more inputs).

OSD Setting

Basic and simple instruction on the control keys.





1. Press any key to display the control menu.
2. Press the  **MENU-button** to activate the OSD window.
3. Press  or  to navigate through the functions. Once the desired function is highlighted, press the  **Enter-button** to activate it. If there is a sub-menu, press  or  to navigate through the sub-menu functions.
4. Press  or  to change the settings of the selected function. Press  **EXIT** to exit. If you want to adjust any other function, repeat steps 2-3.
5. OSD Lock Function: To lock the OSD, press and hold the  **MENU-button** while the monitor is off and then press  **power button** to turn the monitor on. To un-lock the OSD - press and hold the  **MENU-button** while the monitor is off and then press  **power button** to turn the monitor on.

Notes:

1. If the product has only one signal input, the item of "Input Select" is disabled.
2. If the product screen size is 4:3 or input signal resolution is native resolution, the item of "Image Ratio" is disabled.
3. One of Clear vision, DCR, Color Boost, and Picture Boost functions is activated; the other three functions are turned off accordingly.

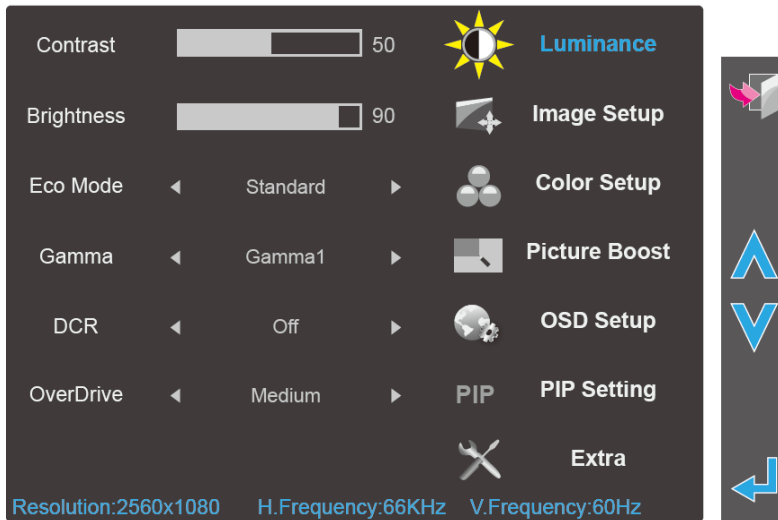

Luminance



1 Press  (Menu) to display menu.

2 Press  or  to select  (Luminance), and press  to enter.

3 Press  or  to select submenu.

4 Press  or  to adjust.

5 Press  to exit.











	Contrast	0-100		Contrast from Digital-register.	
	Brightness	0-100		Backlight Adjustment	
	Eco mode	Standard			Standard Mode
		Text			Text Mode
		Internet			Internet Mode
		Game			Game Mode
		Movie			Movie Mode
		Sports			Sports Mode
	Gamma	Gamma1			Adjust to Gamma 1
		Gamma2			Adjust to Gamma 2
		Gamma3			Adjust to Gamma 3
	DCR	Off			Disable dynamic contrast ratio
		On			Enable dynamic contrast ratio
	OverDrive	Weak			Adjust the response time.
		Medium			
Strong					
Off					



Image Setup

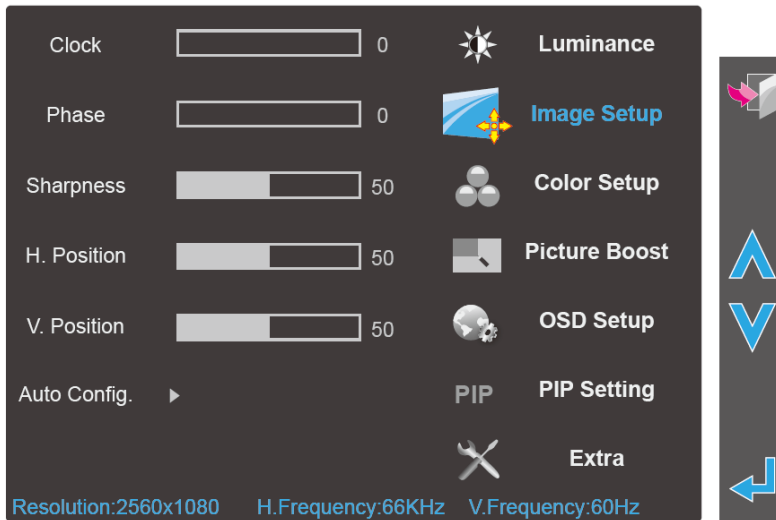

1 Press  (Menu) to display menu.

2 Press  or  to select  (Image Setup), and press  to enter.

3 Press  or  to select submenu.

4 Press  or  to adjust.

5 Press  to exit.



	Clock	0-100	Adjust picture Clock to reduce Vertical-Line noise.
	Phase	0-100	Adjust Picture Phase to reduce Horizontal-Line noise.
	Sharpness	0-100	Adjust picture sharpness.
	H.Position	0-100	Adjust the horizontal position of the picture.
	V.Position	0-100	Adjust the vertical position of the picture.
	Auto Config.		Auto adjust the picture to default.

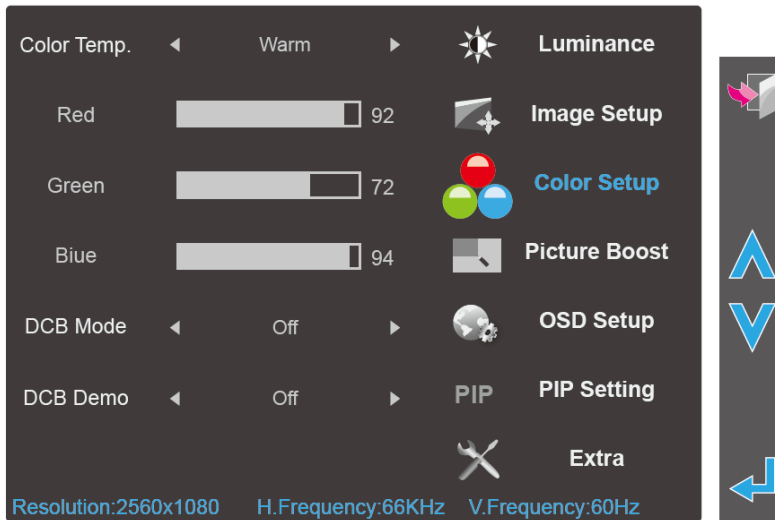

Color Setup



1 Press  (Menu) to display menu.

2 Press  or  to select  (Color Setup), and press  to enter.

3 Press  or  to select submenu.









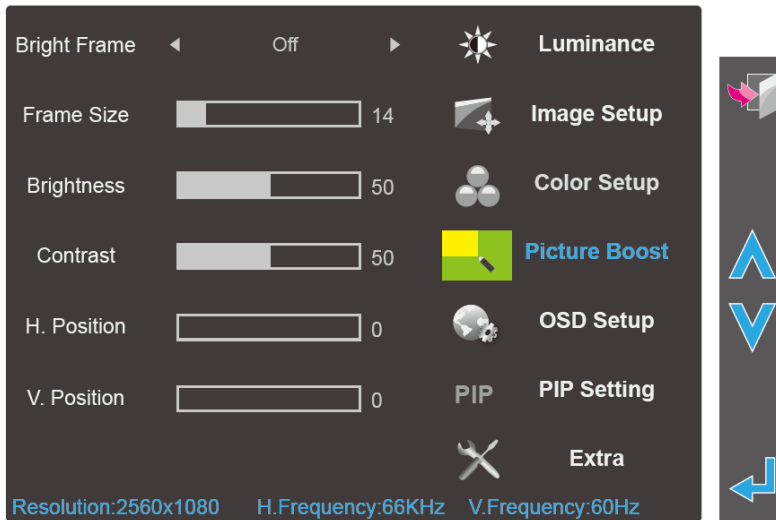

4 Press  or  to adjust.

5 Press  to exit.

	Color Temp.	Warm		Recall Warm Color Temperature from EEPROM.	
		Normal		Recall Normal Color Temperature from EEPROM.	
		Cool		Recall Cool Color Temperature from EEPROM.	
		sRGB		Recall SRGB Color Temperature from EEPROM.	
		User	Red		Red Gain from Digital-register
			Green		Green Gain Digital-register.
			Blue		Blue Gain from Digital-register
	DCB Mode	Full Enhance		Enable Full Enhance Mode	
		Nature Skin		Enable Nature Skin Mode	
		Green Field		Enable Green Field Mode	
		Sky-blue		Enable Sky-blue Mode	
		AutoDetect		Enable AutoDetect Mode	
		Off		Disable DCB Mode	
	DCB Demo	On / Off		Disable or Enable Demo	

Picture Boost



- 1 Press  (Menu) to display menu.
- 2 Press  or  to select  (Picture Boost), and press  to enter.
- 3 Press  or  to select submenu.
- 4 Press  or  to adjust.
- 5 Press  to exit.

	Bright Frame	On / Off	Disable or Enable Bright Frame
	Frame Size	14-100	Adjust Frame Size
	Brightness	0-100	Adjust Frame Brightness
	Contrast	0-100	Adjust Frame Contrast
	H. position	0-100	Adjust Frame horizontal Position
	V. position	0-100	Adjust Frame vertical Position

Note:



Adjust the brightness, contrast, and position of the Bright Frame for better viewing experience.

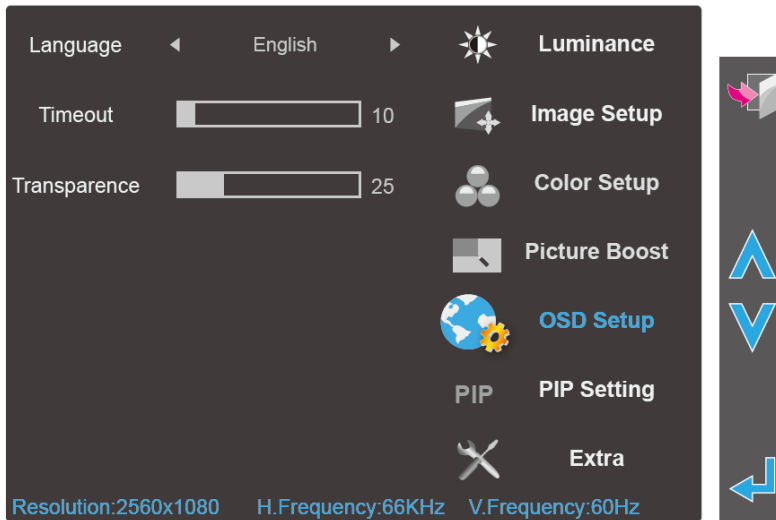

OSD Setup



1 Press  (Menu) to display menu.

2 Press  or  to select  (OSD Setup), and press  to enter.

3 Press  or  to select submenu.







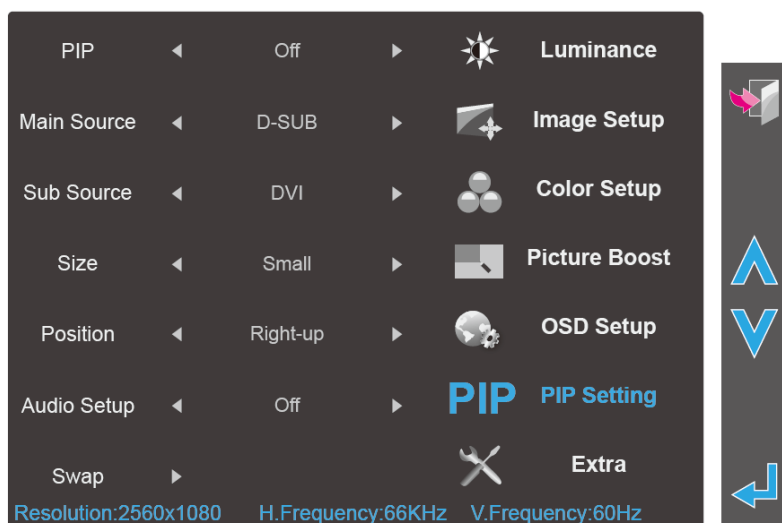

4 Press  or  to adjust.

5 Press  to exit.

	Language	English, Korean, Chinese (Traditional), Chinese(Simplified), Deutsch, France, Español, Italiano, Dutch, Swedish, Portuguese Euro, Portuguese Brazil, Finnish, Russian, Polish, Czech, JP	Select the OSD language
	Timeout	5-120	Adjust the OSD Timeout
	Transparence	0-100	Adjust the transparence of OSD

PIP Setting



- 1 Press  (Menu) to display menu.
- 2 Press  or  to select **PIP**, and press  to enter.
- 3 Press  or  to select submenu.
- 4 Press  or  to adjust.
- 5 Press  to exit.









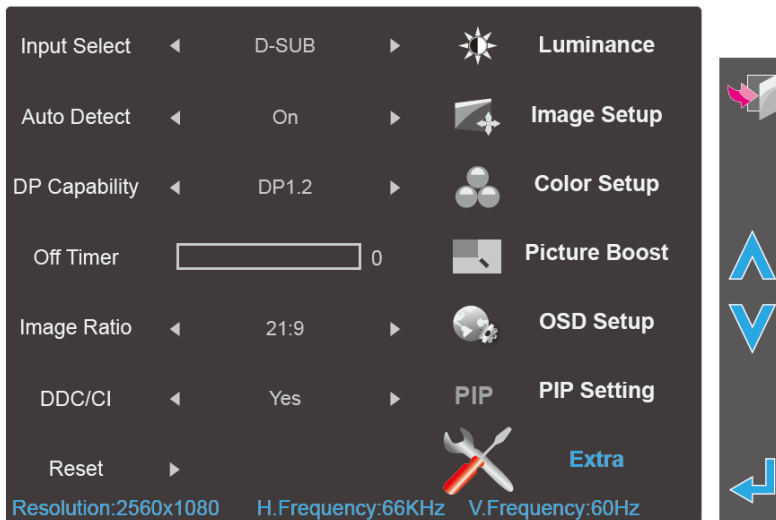

PIP	PIP	Off / PIP / PBP	Disable or Enable PIP or PBP.
	Main Source	D-SUB / DVI / HDMI / DP	Select main screen source.
	Sub Source	D-SUB / DVI / HDMI / DP	Select sub screen source.
	Size	Small / Middle / Large	Select screen size.
	Position	Right-up	Set the screen location.
		Right-down	
		Left-down	
		Left-up	
Center			
Audio Setup	On / Off	Disable or Enable Audio Setup.	
Swap		Swap the screen source.	

Please refer below table for compatibility of main/sub input source.

		Sub			
		VGA	DVI	HDMI/MHL	DP
Main	VGA		√	√	√
	DVI	√			√
	HDMI/MHL	√			√
	DP	√	√	√	

Extra



- 1 Press  (Menu) to display menu.
- 2 Press  or  to select  (Extra), and press  to enter.
- 3 Press  or  to select submenu.
- 4 Press  or  to adjust.
- 5 Press  to exit.

	Input Select	D-SUB / DVI / HDMI / DP	Select input signal source.
	Auto Detect	Yes / No	Disable or Enable power on Auto Detect.
	DP Capability	* DP1.1a / DP1.2 (Daisy Chain)	Select the Display Port competence.
	Off Timer	0-24 hrs	Select DC off time.
	Image Ratio	21 : 9 / 16 : 9 / 16 : 10 / 4 : 3 / 1 : 1	Select image ratio for display.
	DDC-CI	Yes / No	Turn on or off DDC-CI Support.
	Reset		Reset the menu to default.

Notes:

1. Auto Detect set to "On":

When turn on the power, scan all input source from the last memorized input source until detect stable signal. If the signal is found, the screen will display image. If there is no signal found, the screen display "No Signal" OSD and enter Power saving mode. The signal source stays in the last memorized input source.

Auto Detect set to "Off":

When turn on the power, detect the last memorized input source.

If the signal is found, the screen will display image.

If there is no signal found in last memorized input source, the screen display "No Signal" OSD and enter Power saving mode. The signal source stays in the last memorized input source.

2. If the DP video content supports DP1.2, please select DP1.2 for DP Capability; otherwise, please select DP1.1a.

LED Indicator

Status	LED Color
Full Power Mode	Blue / Green
Power Saving	Amber / Red
Active-off Mode	Off

Driver

Monitor Driver

Windows 8

1. Start Windows® 8
2. Right click and click **All apps** at the bottom-right of the screen.

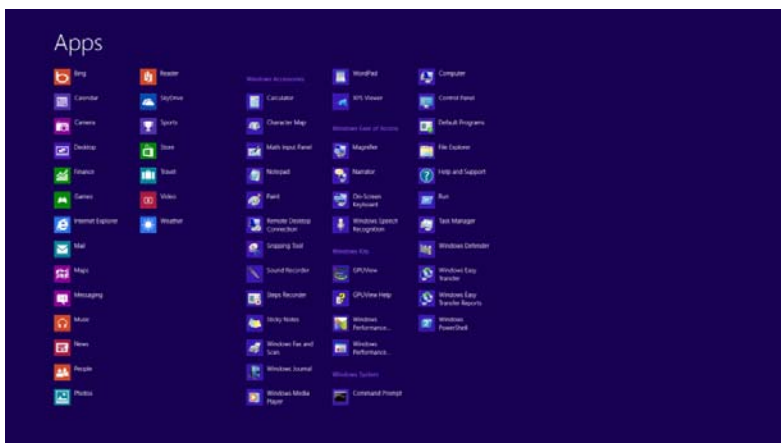
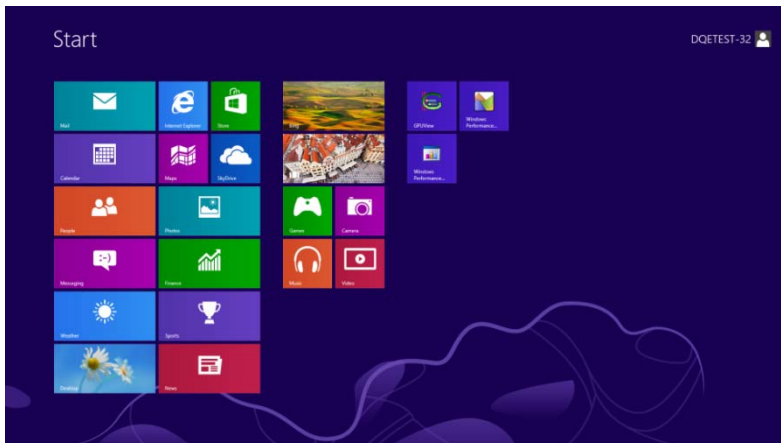

3. Click on the “**Control panel**” icon
4. Set the “**View by**” to “**Large icons**” or “**Small icons**”.

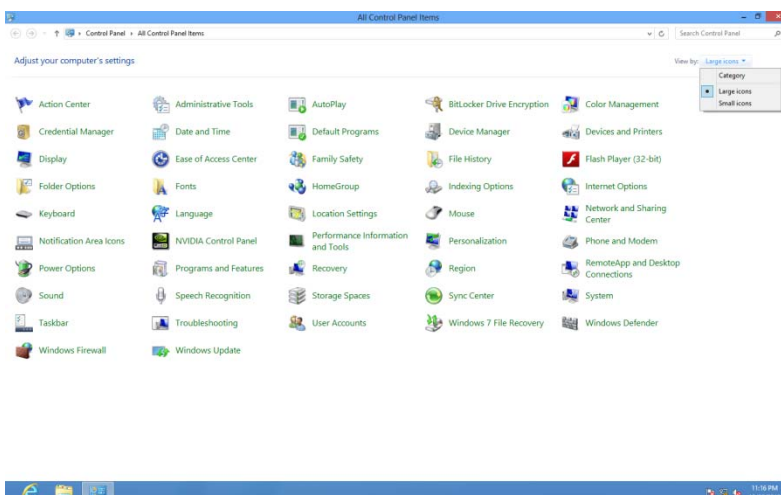

5. Click on the **“Display”** icon.

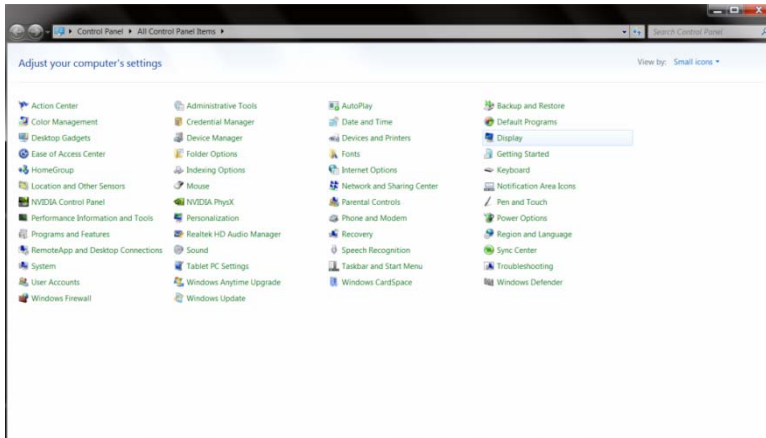

6. Click on the **“Change display settings”** button.

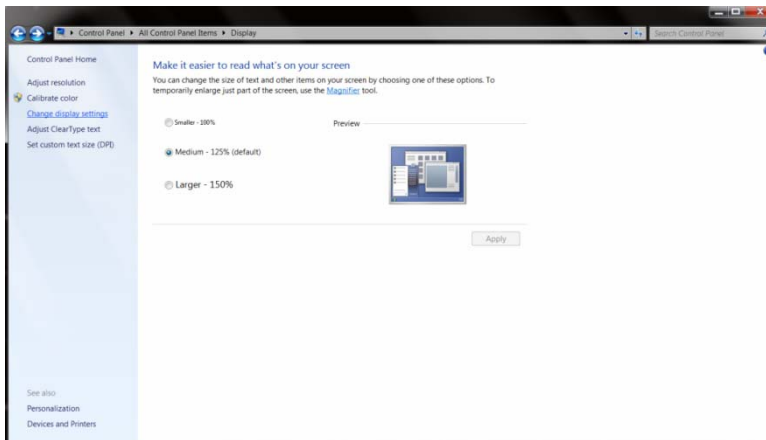

7. Click the **“Advanced Settings”** button.

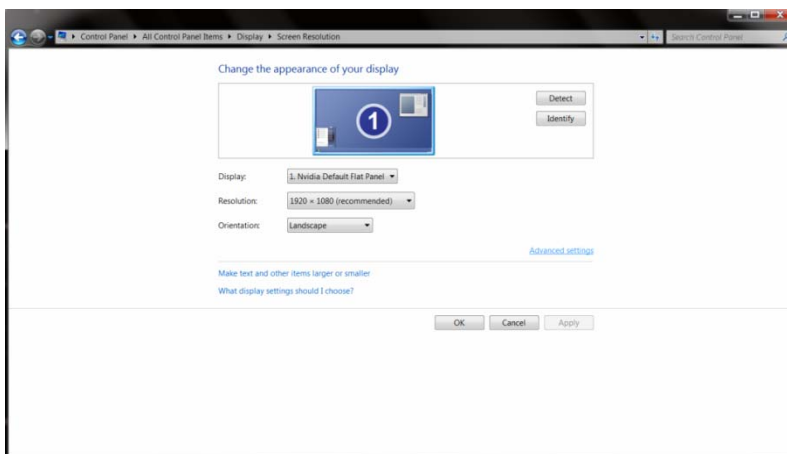

8. Click the **“Monitor”** tab and then click the **“Properties”** button.

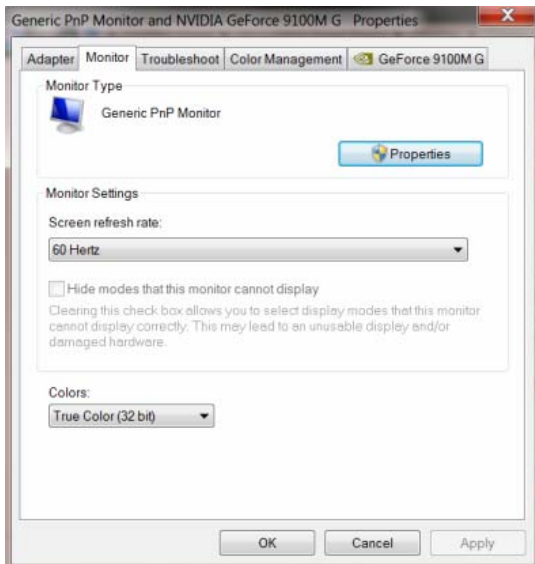

9. Click the **“Driver”** tab.

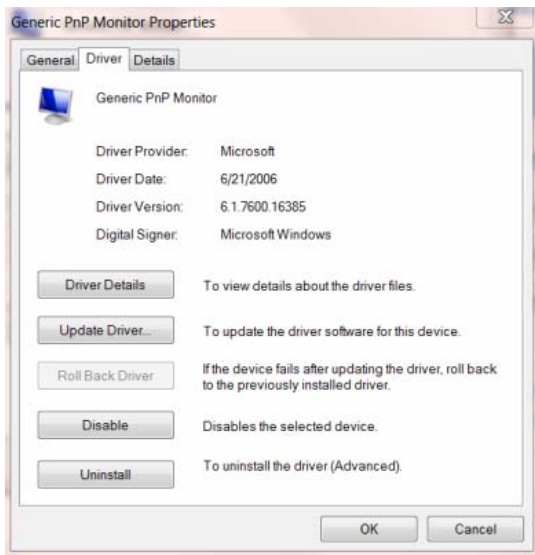

10. Open the **“Update Driver Software-Generic PnP Monitor”** window by clicking on **“Update Driver...”** and then click the **“Browse my computer for driver software”** button.

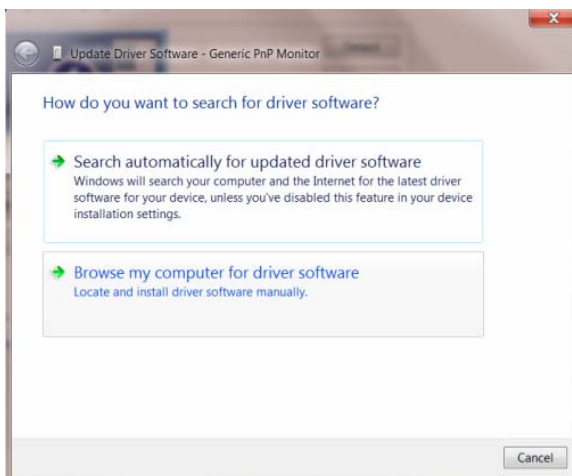

11. Select **“Let me pick from a list of device drivers on my computer”**.

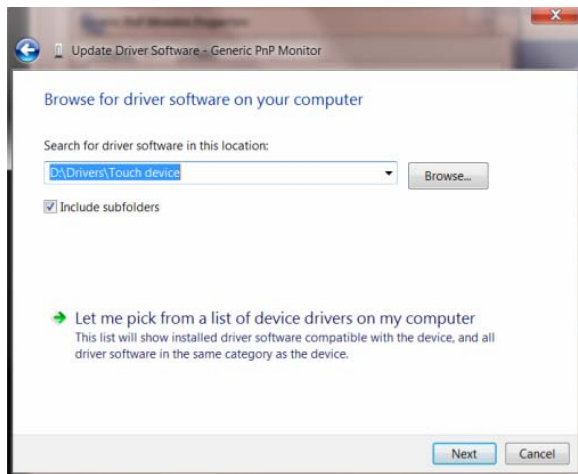

12. Click the **“Have Disk”** button. Click on the **“Browse”** button and navigate to the following directory:
X:\Driver\module name (where X is the drive letter designator for the CD-ROM drive).

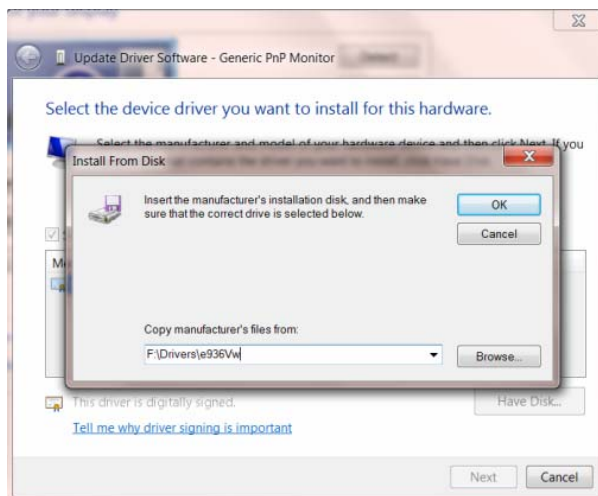

13. Select the **“xxx.inf”** file and click the **“Open”** button. Click the **“OK”** button.
14. Select your monitor model and click the **“Next”** button. The files will be copied from the CD to your hard disk drive.
15. Close all open windows and remove the CD.
16. Restart the system. The system will automatically select the maximum refresh rate and corresponding Color Matching Profiles.

Windows 7

1. Start Windows® 7
2. Click on the **'Start'** button and then click on **'Control Panel'**.

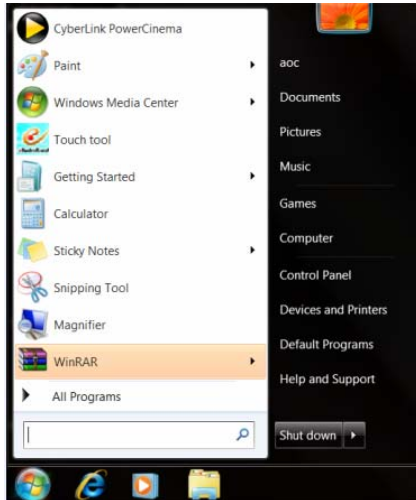

3. Click on the **“Display”** icon.

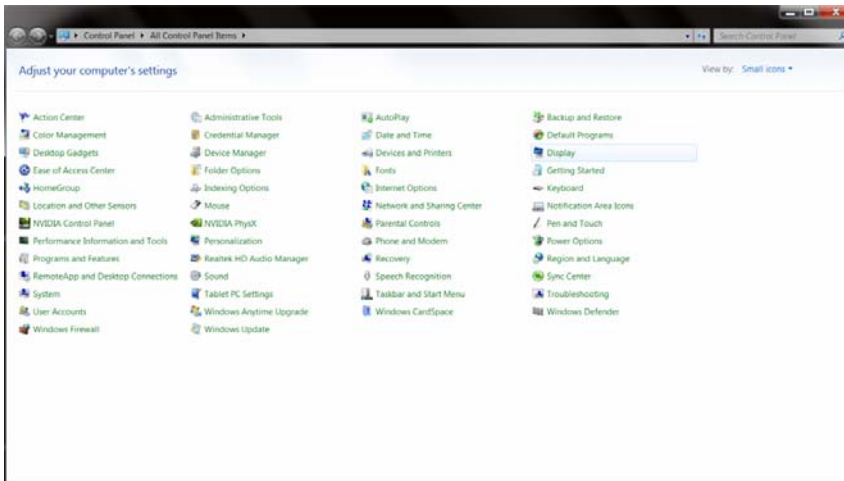

4. Click on the **“Change display settings”** button.

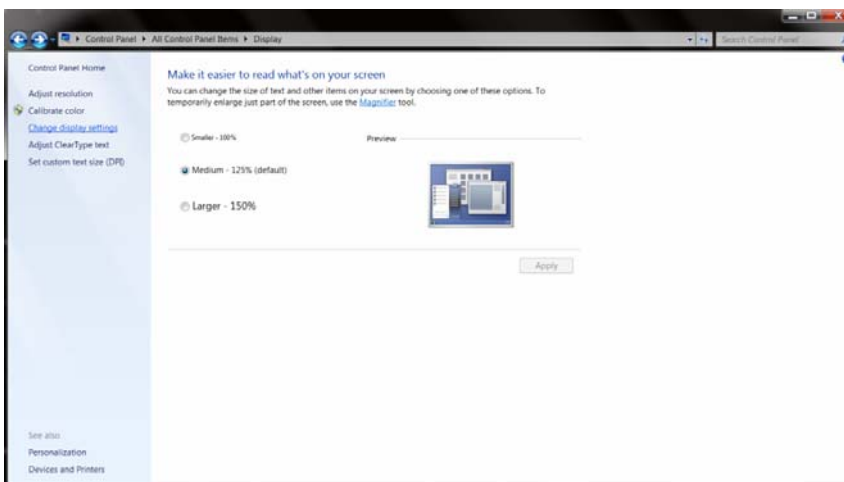

5. Click the **“Advanced Settings”** button.

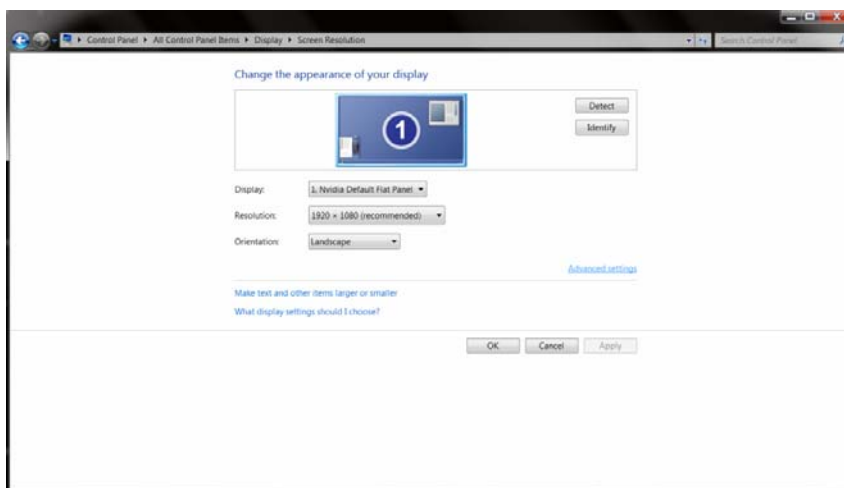

6. Click the "Monitor" tab and then click the "Properties" button.

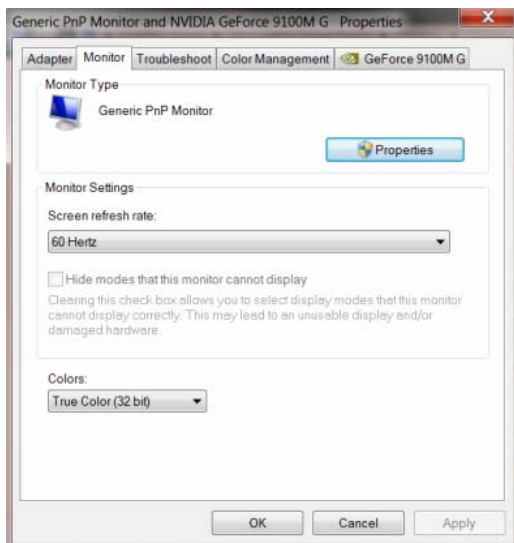

7. Click the "Driver" tab.

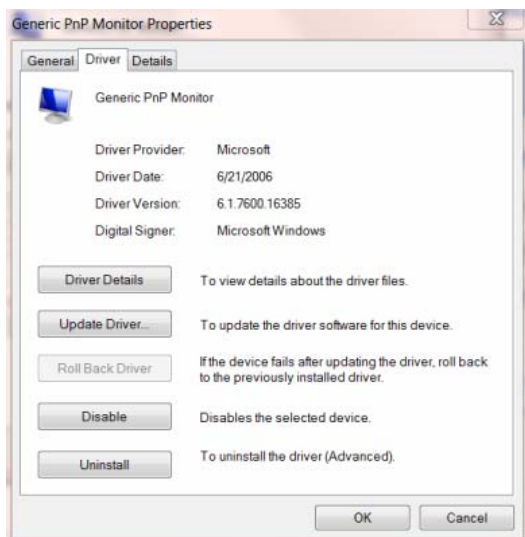

8. Open the "Update Driver Software-Generic PnP Monitor" window by clicking on "Update Driver..." and then click the "Browse my computer for driver software" button.

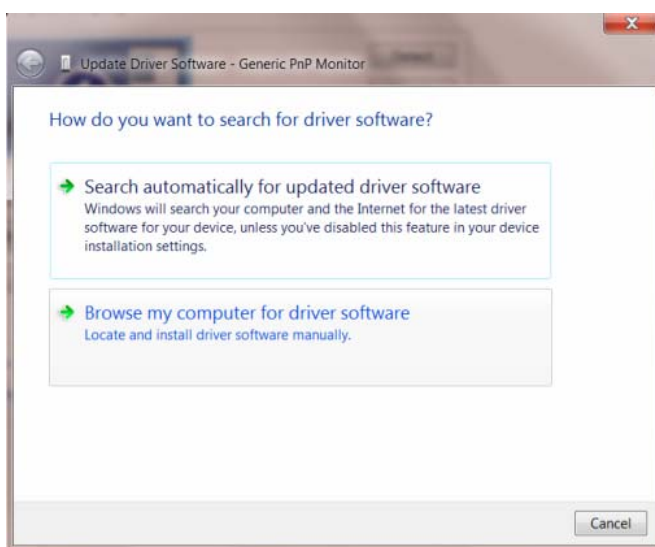

9. Select "Let me pick from a list of device drivers on my computer".

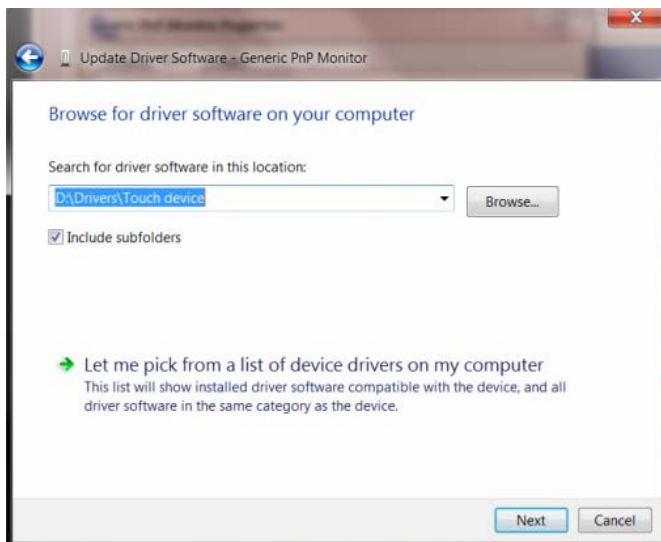

10. Click the "Have Disk" button. Click on the "Browse" button and navigate to the following directory:
X:\Driver\module name (where X is the drive letter designator for the CD-ROM drive).

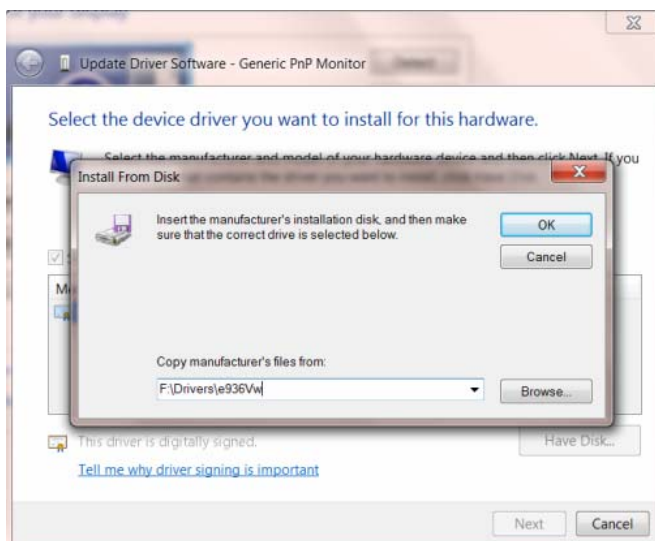

11. Select the "xxx.inf" file and click the "Open" button. Click the "OK" button.

12. Select your monitor model and click the "Next" button. The files will be copied from the CD to your hard disk

drive.

13. Close all open windows and remove the CD.
14. Restart the system. The system will automatically select the maximum refresh rate and corresponding Color Matching Profiles.

Windows Vista

1. Click **"Start"** and **"Control Panel"**. Then, double-click on **"Appearance and Personalization"**.



2. Click **"Personalization"** and then **"Display Settings"**.

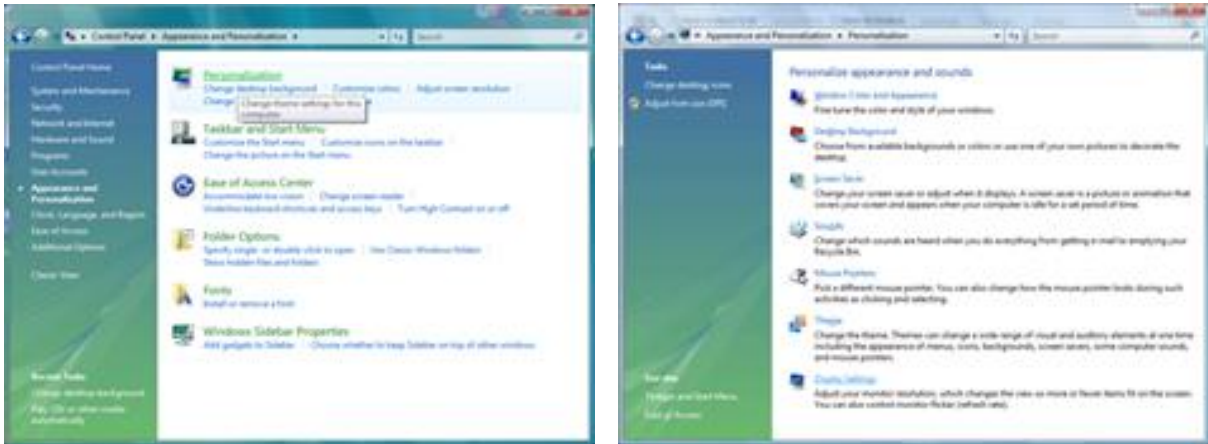

3. Click **"Advanced Settings..."**.



- Click **"Properties"** in the **"Monitor"** tab. If the **"Properties"** button is deactivated, it means the configuration for your monitor is completed. The monitor can be used as is.

If the message **"Windows needs..."** is displayed, as shown in the figure below, click **"Continue"**.



- Click **"Update Driver..."** in the **"Driver"** tab.

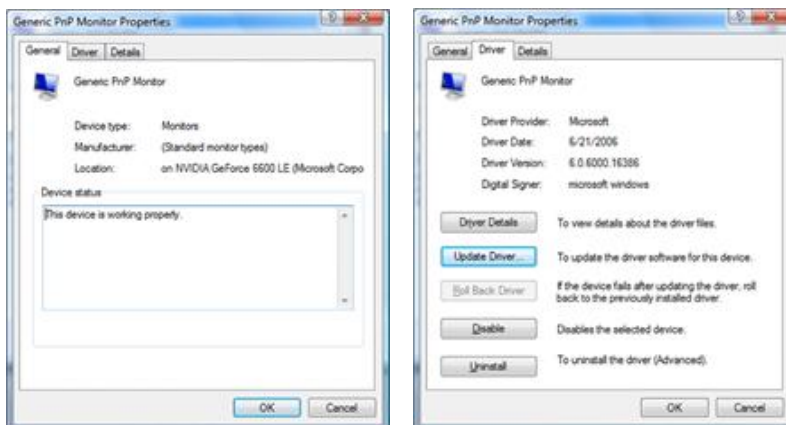

- Check the **"Browse my computer for driver software"** checkbox and click **"Let me pick from a list of device drivers on my computer"**.



- Click on the **"Have disk..."** button, then click on the **"Browse..."** button and then select the appropriate drive F:\Driver (CD-ROM Drive).
- Select your monitor model and click on the **"Next"** button.
- Click **"Close"** → **"Close"** → **"OK"** → **"OK"** on the following screens displayed in sequence.

Windows 2000

1. Start Windows® 2000.
2. Click on the **'Start'** button, point to **'Settings'**, and then click on **'Control Panel'**.
3. Double click on the **'Display'** icon.
4. Select the **'Settings'** tab then click on **'Advanced...'**.
5. Select **'Monitor'**
 - If the **'Properties'** button is inactive, it means your monitor is properly configured. Please stop installation.
 - If the **'Properties'** button is active. Click on **'Properties'** button. Please follow the steps given below.
6. Click on **'Driver'** and then click on **'Update Driver...'** then click on the **'Next'** button.
7. Select **'Display a list of the known drivers for this device so that I can choose a specific driver'**, then click on **'Next'** and then click on **'Have disk...'**.
8. Click on the **'Browse...'** button then select the appropriate drive F: (CD-ROM Drive).
9. Click on the **'Open'** button, then click on the **'OK'** button.
10. Select your monitor model and click on the **'Next'** button.
11. Click on the **'Finish'** button then the **'Close'** button.
 - If you can see the **'Digital Signature Not Found'** window, click on the **'Yes'** button.

Windows ME

1. Start Windows® Me
2. Click on the **'Start'** button, point to **'Settings'**, and then click on **'Control Panel'**.
3. Double click on the **'Display'** icon.
4. Select the **'Settings'** tab then click on **'Advanced...'**.
5. Select the **'Monitor'** button, then click on **'Change...'** button.
6. Select **'Specify the location of the driver (Advanced)'** and click on the **'Next'** button.
7. Select **'Display a list of all the drivers in a specific location, so you can choose the driver you want'**, then click on **'Next'** and then click on **'Have Disk...'**.
8. Click on the **'Browse...'** button, select the appropriate drive F: (CD-ROM Drive) then click on the **'OK'** button.
9. Click on the **'OK'** button, select your monitor model and click on the **'Next'** button.
10. Click on **'Finish'** button then the **'Close'** button.

i-Menu



Welcome to "i-Menu" software by AOC. i-Menu makes it easy to adjust your monitor display setting by using on screen menus instead of the OSD button on the monitor. To complete installation, please follow the installation guide.



e-Saver



Welcome to use AOC e-Saver monitor power management software! The AOC e-Saver features Smart Shutdown functions for your monitors, allows your monitor to timely shutdown when PC unit is at any status (On, Off, Sleep or Screen Saver); the actual shutdown time depends on your preferences (see example below).

Please click on "driver/e-Saver/setup.exe" to start installing the e-Saver software, follow the install wizard to complete software installation.

Under each of the four PC statuses, you may choose the desired time (in minutes) from the pull-down menu for your monitor to automatically shutdown. The example below illustrated:

- 1) The monitor will never shutdown when the PC is powered on.
- 2) The monitor will automatically shutdown 5 minutes after the PC is powered off.
- 3) The monitor will automatically shutdown 10 minutes after the PC is in sleep/stand-by mode.
- 4) The monitor will automatically shutdown 20 minutes after the screen saver appears.

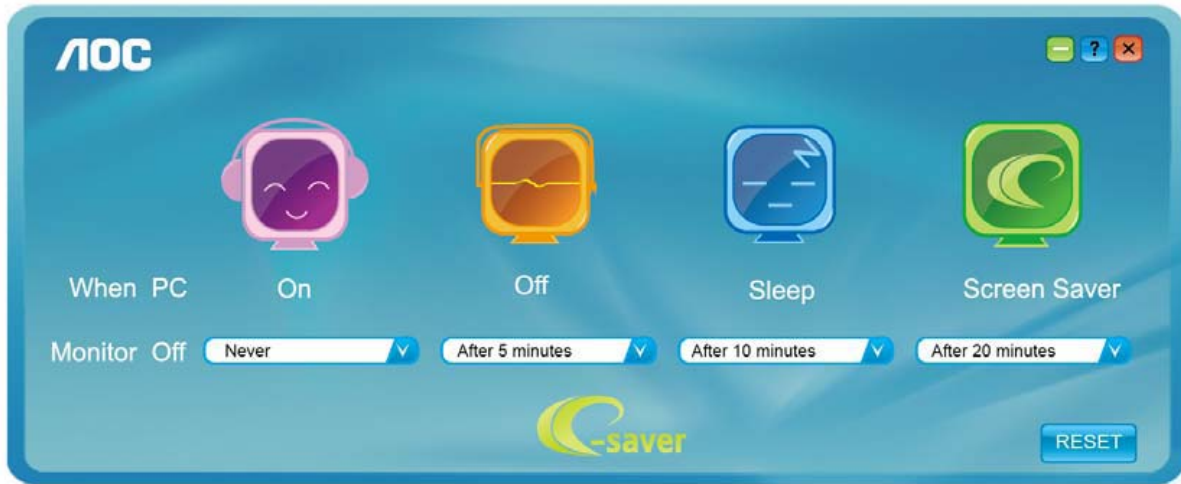

You can click "RESET" to set the e-Saver to its default settings like below.

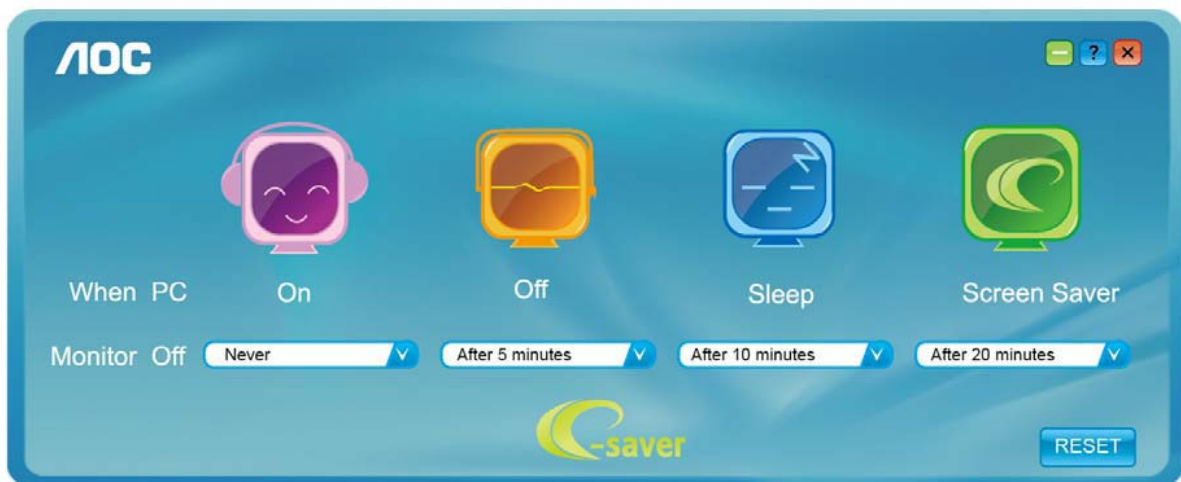

Screen+



Welcome to "Screen+" software by AOC. Screen+ software is a desktop screen splitting tool; it splits the desktop into different panels, and each panel displays a different window. You only need to drag the window to a corresponding panel when you want to access it. It supports multiple monitor display to make your task easier. Please follow the installation software to install it.



Troubleshoot

Problem & Question	Possible Solutions
Power LED Is Not ON	Make sure the power button is ON and the Power Cord is properly connected to a grounded power outlet and to the monitor.
No images on the screen	<ul style="list-style-type: none"> ● Is the power cord connected properly? Check the power cord connection and power supply. ● Is the cable connected correctly? (Connected using the D-sub cable) Check the DB-15 cable connection. (Connected using the DVI cable) Check the DVI cable connection. * DVI input is not available on every model. ● If the power is on, reboot the computer to see the initial screen (the login screen), which can be seen. If the initial screen (the login screen) appears, boot the computer in the applicable mode (the safe mode for Windows ME/2000) and then change the frequency of the video card. (Refer to the Setting the Optimal Resolution) If the initial screen (the login screen) does not appear, contact the Service Center or your dealer. ● Can you see "Input Not Supported" on the screen? You can see this message when the signal from the video card exceeds the maximum resolution and frequency that the monitor can handle properly. Adjust the maximum resolution and frequency that the monitor can handle properly. ● Make sure the AOC Monitor Drivers are installed.
Picture Is Fuzzy & Has Ghosting Shadowing Problem	Adjust the Contrast and Brightness Controls. Press to auto adjust. Make sure you are not using an extension cable or switch box. We recommend plugging the monitor directly to the video card output connector on the back.
Picture Bounces, Flickers Or Wave Pattern Appears In The Picture	Move electrical devices that may cause electrical interference as far away from the monitor as possible. Use the maximum refresh rate your monitor is capable of at the resolution you are using.

<p>Monitor Is Stuck In Active Off-Mode"</p>	<p>The Computer Power Switch should be in the ON position. The Computer Video Card should be snugly fitted in its slot. Make sure the monitor's video cable is properly connected to the computer. Inspect the monitor's video cable and make sure no pin is bent. Make sure your computer is operational by hitting the CAPS LOCK key on the keyboard while observing the CAPS LOCK LED. The LED should either turn ON or OFF after hitting the CAPS LOCK key.</p>
<p>Missing one of the primary colors (RED, GREEN, or BLUE)</p>	<p>Inspect the monitor's video cable and make sure that no pin is damaged. Make sure the monitor's video cable is properly connected to the computer.</p>
<p>Screen image is not centered or sized properly</p>	<p>Adjust H-Position and V-Position or press hot-key (AUTO).</p>
<p>Picture has color defects (white does not look white)</p>	<p>Adjust RGB color or select desired color temperature.</p>
<p>Horizontal or vertical disturbances on the screen</p>	<p>Use Windows 95/98/2000/ME shut-down mode to adjust CLOCK and PHASE. Press to auto-adjust.</p>

Specification

General Specification

Panel	Model name	Q2963PM
	Driving system	TFT Color LCD
	Viewable Image Size	730.025 mm diagonal(Aspect 21:9)
	Pixel pitch	0.0876*RGB(H)mm x 0.2628(V)mm
	Video	R, G, B Analog Interface
	Separate Sync.	H/V TTL
	Display Color	16.7M Colors
	Dot Clock	185.58 MHz
Resolution	Horizontal scan range	30kHz - 99kHz
	Horizontal scan Size(Maximum)	672.768 mm
	Vertical scan range	50Hz - 76Hz
	Vertical scan Size(Maximum)	283.824mm
	Optimal preset resolution	2560×1080@60Hz
	Plug & Play	VESA DDC2B
	Input Connector	VGA/Dual link DVI/MHL/HDMI/DP
	Input Video Signal	Analog: 0.7Vp-p(standard), 75 OHM, Positive
	Output Connector	DP / earphone
	Speaker	3 W x 2
	Power Source	19V, 3.42A
	Power Consumption	65 W(Max) Standby \leq 0.5 W (except HDMI/MHL mode)
Off timer	0-24 hrs	
Physical Characteristics	Connector Type	VGA\ DVI\HDMI\DP in\DP out\ Line in\Earphone out\DC in
	Signal Cable Type	Detachable
	Dimensions & Weight:	
	Height (with base)	387.9mm
	Width	713.6 mm
	Depth	214.3 mm
	Weight (monitor only)	6.90 kg
	Wall Mount	100 x 100 mm
Environmental	Temperature:	
	Operating	0° to 40°
	Non-Operating	-25°to 55°
	Humidity:	
	Operating	10% to 85% (non-condensing)
	Non-Operating	5% to 93% (non-condensing)
	Altitude:	
	Operating	0~ 5000m (0~ 16402 ft)
Non-Operating	0~ 12192m (0~ 40000 ft)	

Since the MHL provides mobile phone charging function and share the same connector with HDMI, Whether the MHL is set to On, Off or Standby mode, the MHL port provides power to charge the connected device simultaneously. In Standby and Off energy saving of ErP not applicable for the MHL charging functionality.

Preset Display Modes

STAND	RESOLUTION	HORIZONTAL FREQUENCY(KHZ)	VERTICAL FREQUENCY(Hz)
VGA	640x480 @60Hz	31.469	59.940
VGA	640x480 @67Hz	35.000	66.667
VGA	640x480 @72Hz	37.861	72.809
VGA	640x480 @75Hz	37.500	75.000
Dos-mode	720x400 @70Hz	31.469	70.087
SVGA	800x600 @56Hz	35.156	56.250
SVGA	800x600 @60Hz	37.879	60.317
SVGA	800x600 @72Hz	48.077	72.188
SVGA	800x600@75HZ	46.875	75.000
Mac-mode	832x624 @75Hz	49.725	74.500
XGA	1024x768 @60Hz	48.363	60.004
XGA	1024x768 @70Hz	56.476	70.069
XGA	1024x768 @75Hz	60.023	75.029
SXGA	1280x1024@60Hz	63.981	60.020
SXGA	1280x1024@75Hz	79.976	75.025
WXGA+	1440x900@60Hz	55.935	59.887
WSXGA	1680x1050@60Hz	64.674	59.883
FULL HD	1920x1080@60Hz	67.500	60.000
WQHD	2560x1080@60Hz	66.636	59.978
HD	1280x960@60Hz	60.000	60.000
HD	1280x720@60HZ	44.772	59.885

Pin Assignments

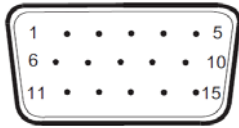

15-Pin Color Display Signal Cable

Pin No.	Signal Name	Pin No.	Signal Name
1	Video-Red	9	+5V
2	Video-Green	10	Ground
3	Video-Blue	11	N.C.
4	N.C.	12	DDC-Serial data
5	Detect Cable	13	H-sync
6	GND-R	14	V-sync
7	GND-G	15	DDC-Serial clock
8	GND-B		

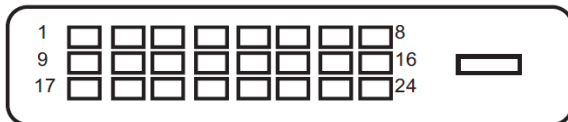

24-Pin Color Display Signal Cable

Pin No.	Signal Name	Pin No.	Signal Name
1	TMDS data 2-	13	TMDS data 3+
2	TMDS data 2+	14	+5V Power
3	TMDS data 2/4 Shield	15	Ground (for+5V)
4	TMDS data 4-	16	Hot Plug Detect
5	TMDS data 4+	17	TMDS data 0-
6	DDC Clock	18	TMDS data 0+
7	DDC Data	19	TMDS data 0/5 Shield
8	N.C.	20	TMDS data 5-
9	TMDS data 1-	21	TMDS data 5+
10	TMDS data 1+	22	TMDS Clock Shield
11	TMDS data 1/3 Shield	23	TMDS Clock +
12	TMDS data 3-	24	TMDS Clock -



19-Pin Color Display Signal Cable

Pin No.	Signal Name	Pin No.	Signal Name
1	TMDS Data 2+	11	TMDS Clock Shield
2	TMDS Data 2 Shield	12	TMDS Clock
3	TMDS Data 2	13	CEC
4	TMDS Data 1+	14	Reserved (N.C. on device)
5	TMDS Data 1Shield	15	SCL
6	TMDS Data 1	16	SDA
7	TMDS Data 0+	17	DDC/CEC Ground
8	TMDS Data 0 Shield	18	+5V Power
9	TMDS Data 0	19	Hot Plug Detect
10	TMDS Clock +		

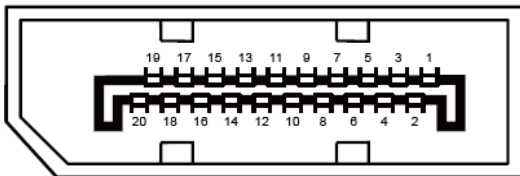

20-Pin Color Display Signal Cable

Pin No.	Signal Name	Pin No.	Signal Name
1	ML_Lane 3 (n)	11	GND
2	GND	12	ML_Lane 0 (p)
3	ML_Lane 3 (p)	13	CONFIG1
4	ML_Lane 2 (n)	14	CONFIG2
5	GND	15	AUX_CH(p)
6	ML_Lane 2 (p)	16	GND
7	ML_Lane 1 (n)	17	AUX_CH(n)
8	GND	18	Hot Plug Detect
9	ML_Lane 1 (p)	19	Return DP_PWR
10	ML_Lane 0 (n)	20	DP_PWR

Plug and Play

Plug & Play DDC2B Feature

This monitor is equipped with VESA DDC2B capabilities according to the VESA DDC STANDARD. It allows the monitor to inform the host system of its identity and, depending on the level of DDC used, communicate additional information about its display capabilities.

The DDC2B is a bi-directional data channel based on the I2C protocol. The host can request EDID information over the DDC2B channel.

Regulation

FCC Notice

FCC Class B Radio Frequency Interference Statement WARNING: (FOR FCC CERTIFIED MODELS)

NOTE: This equipment has been tested and found to comply with the limits for a Class B digital device, pursuant to Part 15 of the FCC Rules. These limits are designed to provide reasonable protection against harmful interference in a residential installation. This equipment generates, uses and can radiate radio frequency energy, and if not installed and used in accordance with the instructions, may cause harmful interference to radio communications. However, there is no guarantee that interference will not occur in a particular installation. If this equipment does cause harmful interference to radio or television reception, which can be determined by turning the equipment off and on, the user is encouraged to try to correct the interference by one or more of the following measures:

Reorient or relocate the receiving antenna.

Increase the separation between the equipment and receiver.

Connect the equipment into an outlet on a circuit different from that to which the receiver is connected.

Consult the dealer or an experienced radio/TV technician for help.

NOTICE:

The changes or modifications not expressly approved by the party responsible for compliance could void the user's authority to operate the equipment.

Shielded interface cables and AC power cord, if any, must be used in order to comply with the emission limits.

The manufacturer is not responsible for any radio or TV interference caused by unauthorized modification to this equipment. It is the responsibilities of the user to correct such interference. It is the responsibility of the user to correct such interference.

WEEE Declaration

Disposal of Waste Equipment by Users in Private Household in the European Union.



This symbol on the product or on its packaging indicates that this product must not be disposed of with your other household waste. Instead, it is your responsibility to dispose of your waste equipment by handing it over to a designated collection point for the recycling of waste electrical and electronic equipment. The separate collection and recycling of your waste equipment at the time of disposal will help to conserve natural resources and ensure that it is recycled in a manner that protects human health and the environment. For more information about where you can drop off your waste equipment for recycling, please contact your local city office, your household waste disposal service or the shop where you purchased the product.

WEEE Declaration for India



This symbol on the product or on its packaging indicates that this product must not be disposed of with your other household waste. Instead it is your responsibility to dispose of your waste equipment by handing it over to a designated collection point for the recycling of waste electrical and electronic equipment. The separate collection and recycling of your waste equipment at the time of disposal will help to conserve natural resources and ensure that it is recycled in a manner that protects human health and the environment.

For more information about where you can drop off your waste equipment for recycling in India, please visit the below web link.

www.aocindia.com/ewaste.php.

EPEAT Declaration



EPEAT is a system to help purchasers in the public and private sectors evaluate, compare and select desktop computers, notebooks and monitors based on their environmental attributes. EPEAT also provides a clear and consistent set of performance criteria for the design of products, and provides an opportunity for manufacturers to secure market recognition for efforts to reduce the environmental impact of its products.

AOC believes in protecting the environment.

With a key concern for the conservation of natural resources, as well as landfill protection, AOC announces the launch of AOC monitor's packaging recycling program. This program is designed to help you discard of your monitor carton and filler materials properly. If a local recycling center is not available, AOC will recycle the packaging material for you, including foam filler and carton. AOC Display solution will only recycle AOC monitor packaging. Please refer to the following website address:

Only for North and South American, excluding Brazil:

http://us.aoc.com/about/environmental_impact

For Germany:

<http://www.aoc-europe.com/en/service/tco.php>

For Brazil:

http://www.aoc.com.br/2007/php/index.php?req=pagina&pgn_id=134

Service

Warranty Statement for Europe

LIMITED THREE-YEAR WARRANTY*

AOC Color Monitors sold within Europe

AOC International (Europe) GmbH warrants this product to be free from defects in material and workmanship for a period of Three (3) years after the original date of consumer purchase. During this period, AOC International (Europe) GmbH will, at its option, either repair the defective product with new or rebuilt parts, or replace it with a new or rebuilt product at no charge except as *stated below. The defective products that are replaced become the property of AOC International (Europe) GmbH.

If the product appears to be defective, please contact your local dealer or refer to the warranty card when attached to the product.

Deliver the product freight pre-paid, along with the dated proof of purchase, to the AOC Authorized Service Center. If you cannot deliver the product in person:

- Pack it in its original shipping container (or equivalent)
- Put the RMA number on the address label
- Put the RMA number on the shipping carton
- Insure it (or assume the risk of loss/damage during shipment)
- Pay all shipping charges

AOC International (Europe) GmbH is responsible neither for any damage or loss during inbound transport damage nor to inbound product that was not properly packaged.

AOC International (Europe) GmbH will pay the return shipping charges within one of the countries specified within this warranty statement. AOC International (Europe) GmbH is not responsible for any costs associated with the transportation of product across international borders. This includes the international border within the European Union.

* This limited warranty does not cover any losses or damages that occur as a result of

- Shipping or improper installation or maintenance
- Misuse
- Neglect
- Any cause other than ordinary commercial or industrial application
- Adjustment by non-authorized source
- Repair, modification, or installation of options or parts by anyone other than an AOC Authorized Service Center
- Improper environment
- Excessive or inadequate heating or air conditioning or electrical powers failures, surges, or other irregularities

This limited warranty does not cover any of the product firmware or hardware that you or any third party have modified or altered; you bear the sole responsibility and liability for any such modification or alteration.

ALL EXPRESS AND IMPLIED WARRANTIES FOR THIS PRODUCT (INCLUDING THE WARRANTIES OF MERCHANTABILITY AND FITNESS FOR A PARTICULAR PURPOSE) ARE LIMITED IN DURATION TO A PERIOD OF THREE (3) YEARS FOR PARTS AND LABOR FROM THE ORIGINAL DATE OF CONSUMER PURCHASE. NO WARRANTIES (EITHER EXPRESSED OR IMPLIED) APPLY AFTER THIS PERIOD.

AOC INTERNATIONAL (EUROPE) GMBH OBLIGATIONS AND YOUR REMEDIES HEREUNDER ARE SOLELY AND EXCLUSIVELY AS STATED HERE. AOC INTERNATIONAL (EUROPE) GMBH LIABILITY, WHETHER BASED ON CONTRACT, TORT, WARRANTY, STRICT LIABILITY, OR OTHER THEORY, SHALL NOT EXCEED THE PRICE OF THE INDIVIDUAL UNIT WHOSE DEFECT OR DAMAGE IS THE BASIS OF THE CLAIM. IN NO EVENT SHALL AOC INTERNATIONAL (EUROPE) GMBH BE LIABLE FOR ANY LOSS OF PROFITS, LOSS OF USE OR FACILITIES OR EQUIPMENT, OR OTHER INDIRECT, INCIDENTAL, OR CONSEQUENTIAL DAMAGE. SOME STATES DO NOT ALLOW THE EXCLUSION OR LIMITATION OF INCIDENTAL OR CONSEQUENTIAL DAMAGES, SO THE ABOVE LIMITATION MAY NOT APPLY TO YOU. ALTHOUGH THIS LIMITED WARRANTY GIVES YOU SPECIFIC LEGAL RIGHTS, YOU MAY HAVE OTHER RIGHTS, WHICH MAY VARY FROM COUNTRY TO COUNTRY. THIS LIMITED WARRANTY IS ONLY VALID FOR PRODUCTS PURCHASED IN THE MEMBER COUNTRIES OF THE EUROPEAN UNION.

Information in this document is subject to change without notice.

For more details, please visit: <http://www.aoc-europe.com/en/service/index.php>

Warranty Statement for North & South America (excluding Brazil)

WARRANTY STATEMENT
for AOC Color Monitors
Including those Sold within North America as Specified

Envision Peripherals, Inc. warrants this product to be free from defects in material and workmanship for a period of three (3) years for parts & labor and one (1) year for CRT Tube or LCD Panel after the original date of consumer purchase. During this period, EPI (EPI is the abbreviation of Envision Peripherals, Inc.) will, at its option, either repair the defective product with new or rebuilt parts, or replace it with a new or rebuilt product at no charge except as *stated below. The parts or product that are replaced become the property of EPI.

In the USA to obtain service under this limited warranty, call EPI for the name of the Authorized Service Center closest to your area. Deliver the product freight pre-paid, along with the dated proof of purchase, to the EPI Authorized Service Center. If you cannot deliver the product in person:

- Pack it in its original shipping container (or equivalent)
- Put the RMA number on the address label
- Put the RMA number on the shipping carton
- Insure it (or assume the risk of loss/damage during shipment)
- Pay all shipping charges

EPI is not responsible for damage to inbound product that was not properly packaged.

EPI will pay the return shipment charges within one of the countries specified within this warranty statement. EPI is not responsible for any costs associated with the transportation of product across international borders. This includes the international borders of the countries within this warranty statements.

In the United States and Canada contact your Dealer or EPI Customer Service, RMA Department at the toll free number (888) 662-9888. Or you can request an RMA Number online at www.aoc.com/na-warranty.

* This limited warranty does not cover any losses or damages that occur as a result of:

- Shipping or improper installation or maintenance
- Misuse
- Neglect
- Any cause other than ordinary commercial or industrial application
- Adjustment by non-authorized source
- Repair, modification, or installation of options or parts by anyone other than an EPI Authorized Service Center
- Improper environment
- Excessive or inadequate heating or air conditioning or electrical power failures, surges, or other irregularities

This three-year limited warranty does not cover any of the product's firmware or hardware that you or any third party have modified or altered; you bear the sole responsibility and liability for any such modification or alteration.

ALL EXPRESS AND IMPLIED WARRANTIES FOR THIS PRODUCT (INCLUDING THE WARRANTIES OF MERCHANTABILITY AND FITNESS FOR A PARTICULAR PURPOSE) ARE LIMITED IN DURATION TO A PERIOD OF THREE (3) YEARS FOR PARTS AND LABOR AND ONE (1) YEAR FOR CRT TUBE OR LCD PANEL FROM THE ORIGINAL DATE OF CONSUMER PURCHASE. NO WARRANTIES (EITHER EXPRESSED OR IMPLIED) APPLY AFTER THIS PERIOD. IN THE UNITED STATES OF AMERICA, SOME STATES DO NOT ALLOW LIMITATIONS ON HOW LONG AN IMPLIED WARRANTY LASTS, SO THE ABOVE LIMITATIONS MAY NOT APPLY TO YOU.

EPI OBLIGATIONS AND YOUR REMEDIES HEREUNDER ARE SOLELY AND EXCLUSIVELY AS STATED HERE. EPI' LIABILITY, WHETHER BASED ON CONTRACT, TORT, WARRANTY, STRICT LIABILITY, OR OTHER THEORY, SHALL NOT EXCEED THE PRICE OF THE INDIVIDUAL UNIT WHOSE DEFECT OR DAMAGE IS THE BASIS OF THE CLAIM. IN NO EVENT SHALL ENVISION PERIPHERALS, INC. BE LIABLE FOR ANY LOSS OF PROFITS, LOSS OF USE OR FACILITIES OR EQUIPMENT OR OTHER INDIRECT, INCIDENTAL, OR CONSEQUENTIAL DAMAGE. IN THE UNITED STATES OF AMERICA, SOME STATES DO NOT ALLOW THE EXCLUSION OR LIMITATION OF INCIDENTAL OR CONSEQUENTIAL DAMAGES. SO THE ABOVE LIMITATION MAY NOT APPLY TO YOU. ALTHOUGH THIS LIMITED WARRANTY GIVES YOU SPECIFIC LEGAL RIGHTS. YOU MAY HAVE OTHER RIGHTS WHICH MAY VARY FROM STATE TO STATE.

In the United States of America, this limited warranty is only valid for Products purchased in the Continental United States, Alaska, and Hawaii.

Outside the United States of America, this limited warranty is only valid for Products purchased in Canada.

Information in this document is subject to change without notice.

For more details, please visit:

USA: http://us.aoc.com/support/find_service_center
ARGENTINA: http://ar.aoc.com/support/find_service_center
BOLIVIA: http://bo.aoc.com/support/find_service_center
CHILE: http://cl.aoc.com/support/find_service_center
COLOMBIA: http://co.aoc.com/support/find_service_center
COSTA RICA: http://cr.aoc.com/support/find_service_center
DOMINICAN REPUBLIC: http://do.aoc.com/support/find_service_center
ECUADOR: http://ec.aoc.com/support/find_service_center
EL SALVADOR: http://sv.aoc.com/support/find_service_center
GUATEMALA: http://gt.aoc.com/support/find_service_center
HONDURAS: http://hn.aoc.com/support/find_service_center
NICARAGUA: http://ni.aoc.com/support/find_service_center
PANAMA: http://pa.aoc.com/support/find_service_center
PARAGUAY: http://py.aoc.com/support/find_service_center
PERU: http://pe.aoc.com/support/find_service_center
URUGUAY: http://pe.aoc.com/support/find_service_center
VENEZUELA: http://ve.aoc.com/support/find_service_center
IF COUNTRY NOT LISTED: http://latin.aoc.com/support/find_service_center

EASE PROGRAM



Only for AOC branded monitors sold within the continental United States.

All AOC branded monitors are now covered by the EASE Program. If your monitor malfunctions at any time during the first three months, AOC will provide a replacement monitor within 72 hours after you are approved for our program. If your monitor qualifies for the EASE program, AOC will pay for freight both ways.

Step 1: Phone our TECH Department at 888.662.9888.

Step 2: Fill out and return EASE registration forms by mail or fax.

Step 3: We will issue a Return Authorization Number upon verification into the program.

Step 4: A monitor will be advance shipped to your location.

Step 5: We will issue a UPS Call Tag to pick up the defective unit.

Step 6: Please review the following chart to see your EASE program qualifications.

WARRANTY PERIOD	COVERAGE AT NO CHARGE	CUSTOMER CHARGES
Within the first three months of purchase: Covered by EASE	- New AOC monitor - Call tag dispatched and return freight charges via UPS	- None*
Between 4 months – 1 Year	- All Parts & Labor Including CRT Tube & LCD Panel	- UPS Return Freight to AOC
Between 1 Year - 3 Years: Covered by standard limited warranty	- Parts & Labor (excluding CRT Tube & LCD Panel)	- UPS Return Freight to AOC

*AOC will need to obtain a credit card number if you would like to get a new AOC monitor advanced shipped to your location, prior to the defective unit arriving at AOC's service center. If you do not wish to supply a credit card, AOC will only ship the new monitor, once the defective unit arrives at the AOC service center.



Congratulations!

This product is designed for both you and the planet!



TCO Development works for sustainable IT - manufacture, use and recycling of IT products reflecting environmental, social and economic responsibility.

TCO Certified is a third party verified program, where every product model is tested by an accredited impartial test laboratory. TCO

Certified represents one of the toughest certifications for ICT products worldwide.

Some of the Usability features of TCO Certified Displays:

- Visual Ergonomics for image quality is tested to ensure top performance and reduce sight and strain problems. Important parameters are Resolution, Luminance, Contrast, Reflection and Colour characteristics
- Products are tested according to rigorous safety standards at impartial laboratories
- Electric and magnetic fields emissions as low as normal household background levels
- Workload ergonomics to ensure a good physical environment

Some of the Environmental features of TCO Certified Displays:

- Production facilities have an Environmental Management System (EMAS or ISO 14001)
- Low energy consumption to minimize climate impact
- Restrictions on Chlorinated and Brominated flame retardants, plasticizers, plastics and heavy metals such as cadmium, mercury and lead (RoHS compliance)
- Both product and product packaging is prepared for recycling
- The brand owner offers take-back options

Corporate Social Responsibility

- The brand owner demonstrates the product is manufactured under working practices that promote good labour relations and working conditions.

The Criteria Document can be downloaded from our web site. The criteria included in this label have been developed by TCO Development in co-operation with scientists, experts, users as well as manufacturers all over the world. Since the end of the 1980s TCO has been involved in influencing the development of IT equipment in a more user and environmentally friendly direction. Our ICT product labeling system began in 1992 and is now requested by users and ICT-manufacturers all over the world.

For more information, please visit
www.tcodevelopment.com

TCO Certified Document for Displays version 2.3



Technology for you and the planet

(FOR TCO CERTIFIED MODELS)