

# NPort 6110 Modbus/TCP to Serial Communication Gateway

---

## User's Manual

Third Edition, April 2005



### **Moxa Technologies Co., Ltd.**

Tel: +886-2-8919-1230  
Fax: +886-2-8919-1231  
Web: [www.moxa.com](http://www.moxa.com)

#### **MOXA Technical Support**

Worldwide: [support@moxa.com.tw](mailto:support@moxa.com.tw)  
The Americas: [support@moxa.com](mailto:support@moxa.com)

# NPort 6110 Modbus/TCP to Serial Communication Gateway

The software described in this manual is furnished under a license agreement and may be used only in accordance with the terms of that agreement.

## Copyright Notice

Copyright © 2005 Moxa Technologies Co., Ltd.  
All rights reserved.  
Reproduction without permission is prohibited.

## Trademarks

MOXA is a registered trademark of The Moxa Group.  
All other trademarks or registered marks in this manual belong to their respective manufacturers.

## Disclaimer

Information in this document is subject to change without notice and does not represent a commitment on the part of Moxa.

Moxa provides this document “as is,” without warranty of any kind, either expressed or implied, including, but not limited to, the particular purpose. Moxa reserves the right to make improvements and/or changes to this manual or the product(s) and/or program(s) described herein at any time.

Information provided in this manual is intended to be accurate and reliable. However, Moxa Technologies assumes no responsibility for its use, or for any infringements on the rights of fourth parties which may result from its use.

This manual could include unintentional technical or typographical errors. Changes are periodically made to the information herein, with the changes incorporated into new editions of the publication.

# MOXA Internet Services

Customer satisfaction is our number one concern. To ensure that customers receive the full benefit of our products, Moxa Internet Services has been set up to provide technical support, driver updates, product information, and user's manual updates.

The following services are provided:

E-mail for technical support

Worldwide: [support@moxa.com.tw](mailto:support@moxa.com.tw)

The Americas: [support@moxa.com](mailto:support@moxa.com)

World Wide Web (WWW) site for product information

address: <http://www.moxa.com>

or <http://www.moxa.com.tw>

# Table of Contents

<b>1. Introduction</b>	<b>1-1</b>
Overview	1-1
Features	1-2
Product Specifications	1-3
Package Checklist	1-4
Front/Top/Rear/Bottom Panel Views	1-5
<b>2. Getting Started</b>	<b>2-1</b>
Power Connection	2-1
Serial Installation	2-1
Ethernet Installation	2-2
Software Installation	2-2
Housing	2-7
DIN-Rail	2-7
Wall Mount	2-8
<b>3. Typical Modbus Applications</b>	<b>3-1</b>
Serial master device talks to serial slave devices over the Internet	3-1
Ethernet master devices talk to multiple serial slave devices	3-2
Serial master devices talk to multiple Ethernet slave devices	3-3
<b>4. Configuring Modbus Gateway</b>	<b>4-1</b>
Starting Modbus Gateway Configurator	4-2
Searching for NPort 6110	4-3
Broadcast Search	4-3
Specify by IP Address	4-3
Modify Configuration	4-4
Network Settings	4-5
Modbus Settings	4-6
Advanced Modbus Settings	4-9
Modbus Serial Settings	4-12
Password	4-14
Other Functions	4-15
Unlock	4-15

Upgrade Firmware .....	4-15
Remote Monitoring and Management.....	4-17
<b>5. Troubleshooting .....</b>	<b>5-1</b>
<b>6. Pin Assignments.....</b>	<b>6-1</b>
<b>A. Declaration of Conformity.....</b>	<b>A-1</b>
<b>B. Problem Report Form.....</b>	<b>B-1</b>

# Introduction

---

Welcome to Moxa *NPort 6110 Modbus/TCP to Serial Communication Gateway*, an easy-to-use Ethernet to RS-232/422/485 Modbus Gateway.

This chapter is an introduction to NPort 6110 and includes the following sections:

- Overview
- Features
- Product Specifications
- Package Checklist
- Front/Top/Rear/Bottom Panel Views

## Overview

Moxa NPort 6110 Modbus/TCP to Serial Communication Gateway provides users with many excellent benefits, including:

- Seamless integration of Ethernet and serial Modbus devices
- Powerful operation modes for versatile Modbus applications
- Windows utility for easy setup and traffic monitoring

Each of these benefits is explained in more detail below.

## Seamless integration of Ethernet and serial Modbus devices

Modbus is one of the most popular automation protocols in the world. Modbus protocol supports traditional RS-232/422/485 devices and newly developed Ethernet devices. Many industrial devices, such as PLCs, DCSs, HMIs, instruments, and meters, use Modbus as their communication standard. However, the Modbus protocols that run over serial and Ethernet are so different that a communication gateway is needed as a bridge for integration.

NPort 6110 supports one Ethernet and one software selectable RS-232/422/485

port that can connect to many types of Modbus device. By translating Modbus/TCP (Ethernet) and Modbus/ASCII/RTU (Serial) protocols, a PLC with Ethernet can use the RS-232/485 interface to seamlessly communicate with instruments.

## Powerful operation modes for versatile Modbus applications

For Modbus protocol conversions, it is necessary to define a Master and Slave device, but unlike other Modbus Gateways, NPort 6110 allows users to configure Master/Slave for both the Ethernet and serial sides.

Extra address mapping and exception parameters are provided to ensure that most situations can be handled.

## Windows utility for easy setup and traffic monitoring

NPort 6110 is powerful yet very easy to use. An intuitive Windows utility automatically searches for all available NPort 6110 units on the LAN.

Traffic Monitoring within the utility helps you troubleshoot any Modbus communication problem, such as connection status check, or address translation error check.

## Features

- Integration of Modbus serial and Modbus Ethernet devices
- Supports connecting a Modbus/TCP Master device to up to 31 Modbus/ASCII/RTU slave devices
- Supports connecting a Modbus/ASCII/RTU master device to up to 4 Modbus/TCP slave devices
- Easy-to-use Windows utility for configuration over Ethernet
- 10/100M fast Ethernet with automatic IP setting (DHCP)
- One software selectable RS-232/485/422 interface
- High speed serial interface—up to 230.4 Kbps

# Product Specifications

## LAN

Ethernet	10/100 Mbps, RJ45
Protection	Built-in 1.5 KV magnetic isolation

## Serial

Interface	RJ-232/422/485 x 1, DB9 (M), software selectable
RS-232 Signals	TxD, RxD, RTS, CTS, DTR, DSR, DCD, GND
RS-422 Signals	Tx+, Tx-, Rx+, Rx-, RTS+, RTS-, CTS+, CTS-, GND
RS-485 2-wire Signals	Data+(A), Data-(B), GND
Serial Line Protections	15 KV ESD for all signals
RS-485 Data Direction	Patented ADDC™ (Automatic Data Direction Control)

## Serial Communication Parameters

Parity	None, Even, Odd
Data Bits	7, 8
Stop Bit	1, 2
Flow Control	RTS/CTS, XON/XOFF
Speed	1200 bps to 230.4 Kbps

## Software Features

Internet Protocols	DHCP, BootP, TCP, UDP, IP, ICMP, ARP
Modbus Protocols	Modbus/TCP, Modbus/ASCII, Modbus/RTU, Master/Slave modes supported
Utilities	Modbus Gateway Configurator for Windows 95/98/Me/NT/2000/XP
Configuration	Windows utility via Ethernet

## Power Requirements

Power Input	9 to 30 VDC
Power Consumption	300 mA at 12V (max.)

## Mechanical Specifications

Material	Aluminum sheet metal (1 mm)
Gross Weight	0.88 kg (1.94 lb)



## **Environmental**

Operating Temperature 0 to 55°C (32 to 131°F), 5 to 95% RH

Storage Temperature -20 to 85°C (-4 to 185°F), 95% RH

## **Regulatory Approvals**

EMC FCC Class B, CE Class B

Safety CUL, TÜV

# **Package Checklist**

NPort 6110 Modbus/TCP to Serial Communication Gateway with 100-240 VAC power adaptor (US, Euro plugs included)

### **All models include:**

- NPort 6110
- Software and documentation CD-ROM
- 100-240 VAC power adapter, US plug, 12V, 400 mA
- Euro plug included

### **Optional Accessories:**

- DK-35A DIN-Rail Mounting Kit (35 mm)

# Front/Top/Rear/Bottom Panel Views

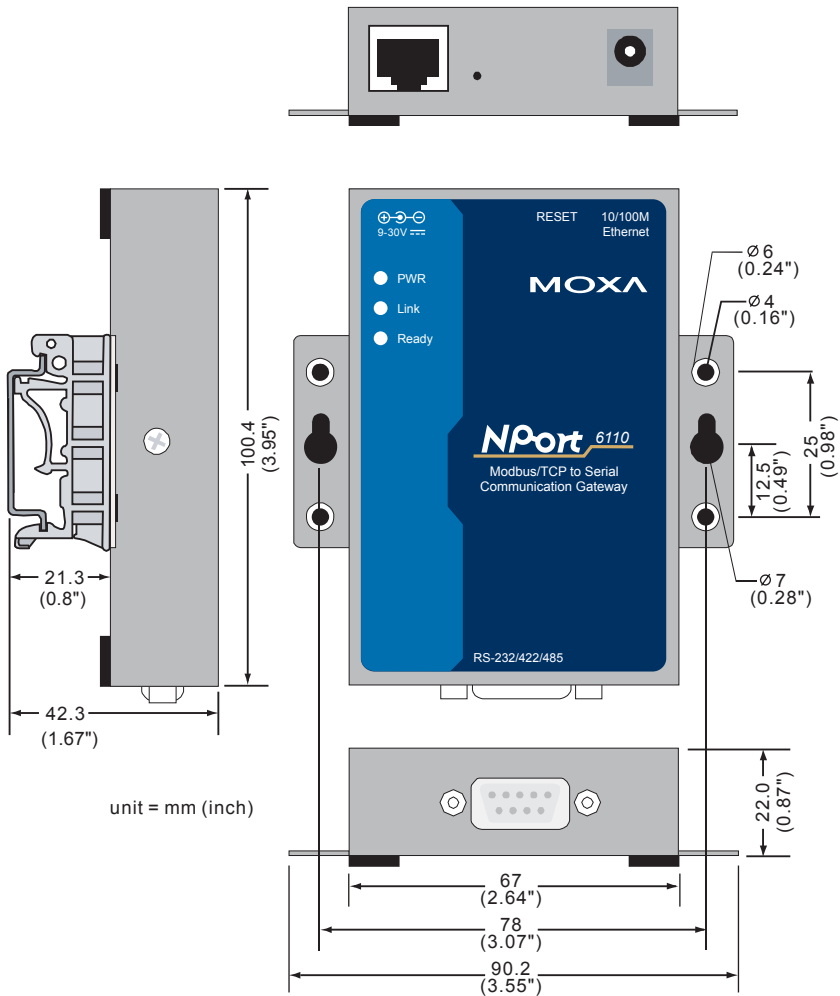

This chapter includes:

- Power Connection
- Serial Installation
- Ethernet Installation
- Software Installation
- Housing
  - DIN-Rail
  - Wall Mount

### Power Connection

Take the following steps to connect NPort 6110's power adapter.

1. Plug the power adapter's DC plug into NPort 6110's DC-IN jack.
2. Plug the power adapter into an electrical outlet.

Note that there is no on/off switch. NPort 6110 automatically turns on when plugged into the outlet, and the red **PWR** light on NPort 6110's top panel will glow to indicate that it is receiving power.

### Serial Installation

NPort 6110 has one male DB9 serial port on the back panel. Depending on your serial device and serial interfaces, there are two options:

1. You may use a DB9 to DB9 cable to connect your serial device to NPort 6110. Plug one end of the cable into the port on the back panel of NPort 6110 and plug the other end into your serial device's serial port.
2. Refer to Chapter 8 for details of NPort 6110's DB9 pinouts to make your own serial interface cable.

# Ethernet Installation

There are two ways to use the 10/100BaseT Ethernet jack located on NPort 6110's front panel:

1. For most applications using NPort 6110, you will simply plug one end of an Ethernet cable into NPort 6110's 100BaseT jack, and plug the other end into an Ethernet hub/switch connected to your network. In this case, use a regular *straight-through* Ethernet cable.
2. When configuring NPort 6110, you may connect NPort 6110 directly to your computer's Ethernet connector. To do this you will need to use a *cross-over* Ethernet cable.

The amber Link light will flicker when NPort 6110 is properly connected to a live Ethernet connection.

# Software Installation

Follow the instructions given below to install **Modbus Gateway Configurator**, the utility that allows you to configure and monitor multiple NPort 6110 units over the network.

1. Insert the software CD-ROM that came with NPort 6110 into the CD-ROM drive, and then double click on the **Setup.exe** icon that installs the NPort Modbus Gateway Utility.



2. You will be greeted by the **Welcome** window. Click on **Next** to continue.

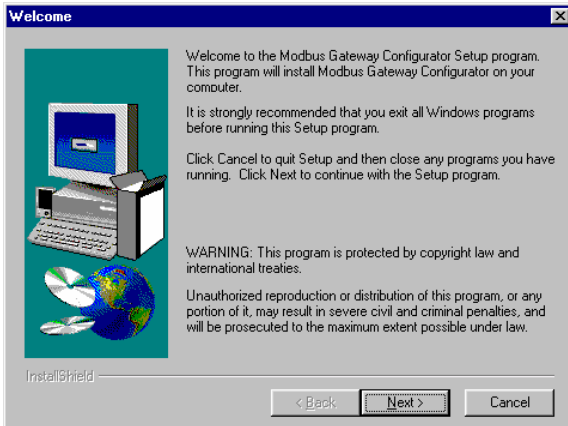

3. Enter your **Name** and **Company** name in the spaces provided, and then click on **Next** to continue.

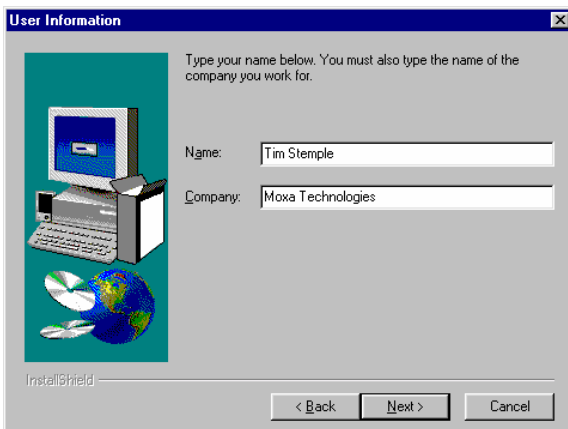

4. When the **Choose Destination Location** window appears, click on **Next** to continue. If you would like to use a Destination Directory different than the one displayed, first click on **Browse...** to locate your folder of choice, and then click on **Browse**.

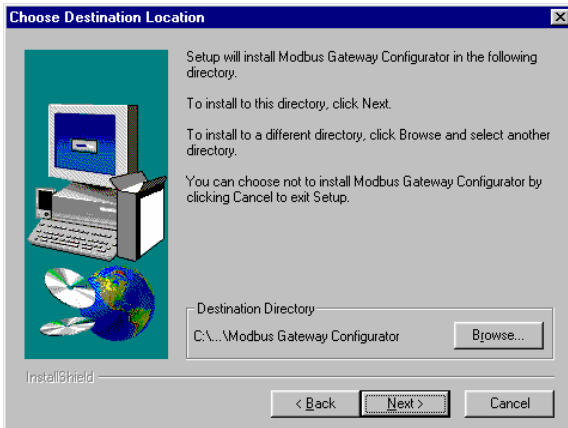

5. If desired, modify the highlighted name in the Program Folders text box (this is the name that will appear under **Start → Programs**) and then click on **Next** to continue.

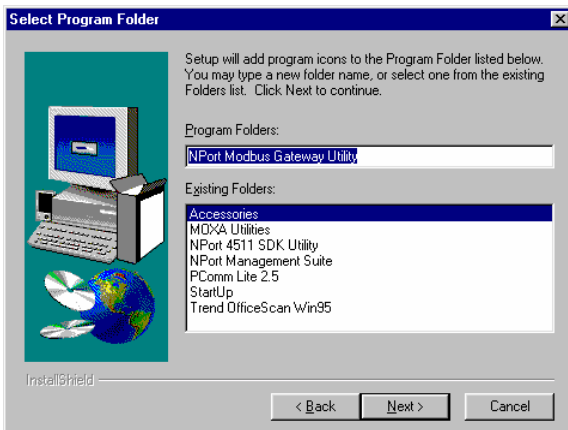

6. Click on **Next** to start copying the software files.

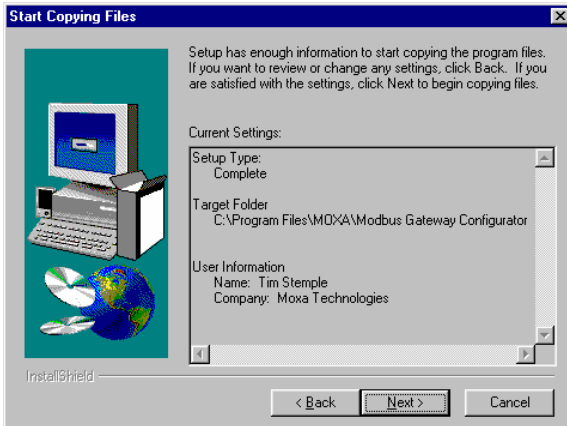

7. Wait patiently while the files are being copied. The procedure should only take a few seconds.

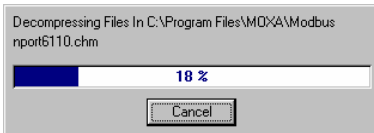

8. The NPort Modbus Gateway Utility folder will open showing the Modbus Gateway Configurator icon.

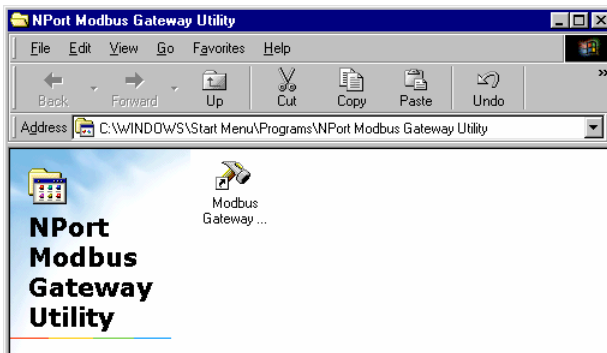

9. You may also view this program shortcut by clicking on **Start → Programs → NPort Modbus Gateway Utility → Modbus Gateway Configurator**, as shown below.

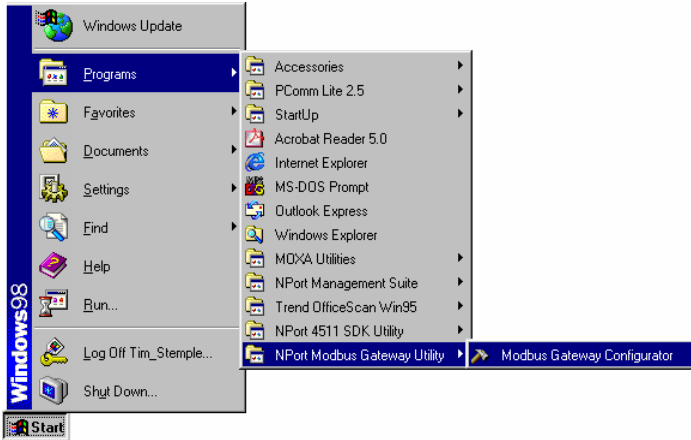



# Housing

## DIN-Rail

For many industrial applications, you will find it convenient to use the DIN-Rail attachments, as shown below.

STEP 1: Use 2 screws per ear to attach DIN-Rail mounts to each of NPort 6110's two ears.

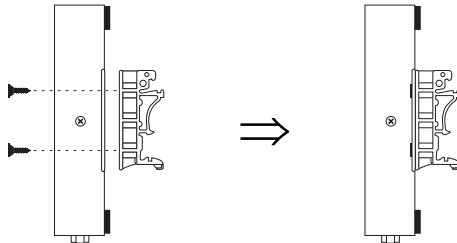

STEP 2: Insert the top of the DIN-Rail into the top slot of the DIN-Rail mount.

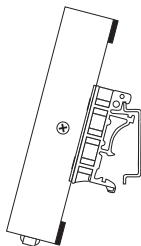

STEP 3: Push the bottom of NPort 6110 so that the bottom of the DIN-Rail snaps into DIN-Rail mount's bottom slot.

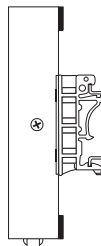

*NOTE: The DIN-Rail mounting kit is an optional accessory.*

To remove NPort 6110 from the DIN-Rail, simply reverse Steps 2 and 3 above. Grasp the bottom of the NPort 6110 unit with both hands, and then use your fingers to pull down slightly on the bottom slot of the DIN-Rail mounts to release the bottom of the DIN-Rail from the DIN-Rail mount.

# Wall Mount

For many industrial applications, you will find it convenient to mount NPort 6110 on the wall, using two screws, as indicated below.

**STEP 1:** Screw two screws, separated by 7.8 cm, into the wall. The heads of the screws should be no greater than 6.5 mm in diameter, and the shafts should be no greater than 3 mm in diameter. Do not screw the screws in all the way—leave a space of about 2 mm to allow room for sliding the NPort 6110 unit's ears between the wall and the screws.

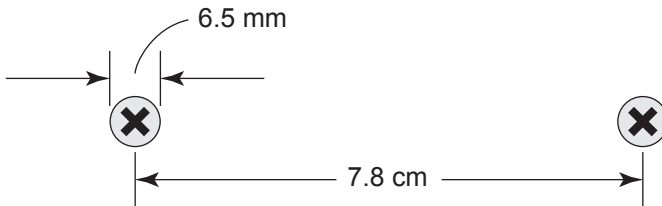

**STEP 2:** Insert the two screw heads through the large parts of the keyhole shaped apertures, and then slide NPort 6110 downwards, as indicated.

**STEP 3:** For added stability, tighten the two screws.

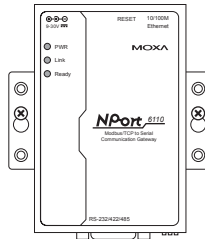
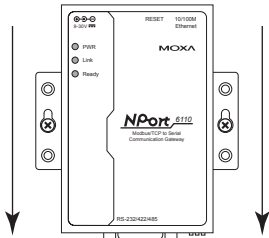

To remove NPort Express from the wall mount, simply reverse Steps 2 and 3.

## Typical Modbus Applications

In this chapter, we introduce three typical Modbus applications.

### Serial master device talks to serial slave devices over the Internet

*Let traditional Modbus serial devices talk over the Internet...*

Many traditional serial Modbus devices can talk over RS-485, but the RS-485 network limits the maximum number of Modbus devices to 32, provided the transmission distance does not exceed 1.2 km.

By using Modbus Gateway, you can link all Serial Modbus devices over an Ethernet network. Up to 4 Modbus Gateways can be installed in the same control network, extending the coverage of a single Modbus network as far as a TCP/IP network can reach.

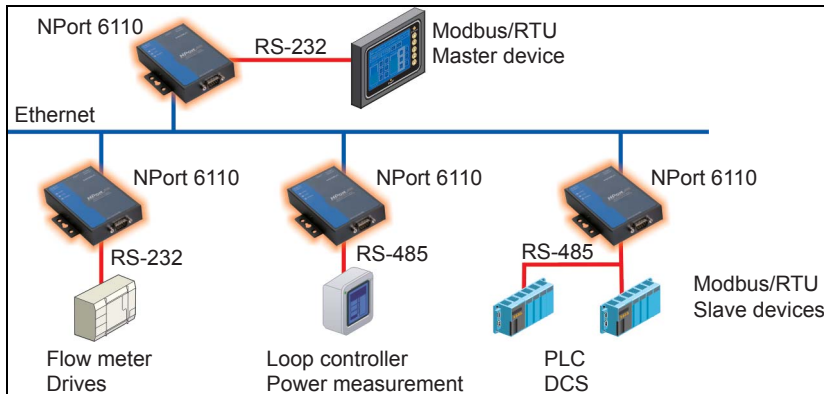

# Ethernet master devices talk to multiple serial slave devices

*Connect all Modbus devices over the Ethernet network...*

Most host computers and newly developed PLCs support the Ethernet interface and run Modbus/TCP. NPort 6110 Modbus Gateway is needed to link discrete Serial Modbus Devices for data collection and control.

Each NPort 6110 supports Modbus/TCP over Ethernet, which allows up to 7 connections. The software configurable serial interface supports either RS-232 or RS-422/485. In RS-232/422 modes, NPort 6110 can be connected to 1 serial device. Under RS-485 mode, NPort 6110 supports up to 31 serial devices, which is the most popular application for factory floor applications.

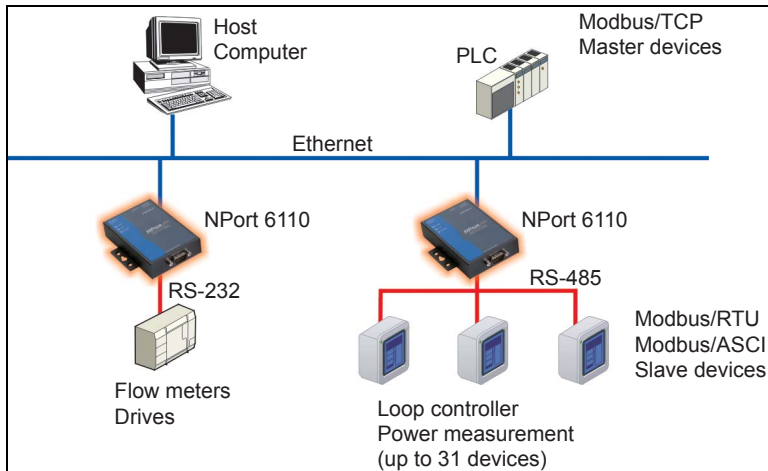

# Serial master devices talk to multiple Ethernet slave devices

*Link the Serial Master device with Ethernet Slave devices...*

Many HMI (Human Machine Interface) systems use a serial interface and are required to access a discrete DCS (Data Control System). These days however, more and more DCSs support Ethernet and run under Modbus/TCP slave mode.

In this case, NPort 6110 Modbus Gateway is the ideal solution to link the HMI to distributed DCSs over an Ethernet network. Up to 4 Modbus/TCP slave devices are supported by each NPort 6110.

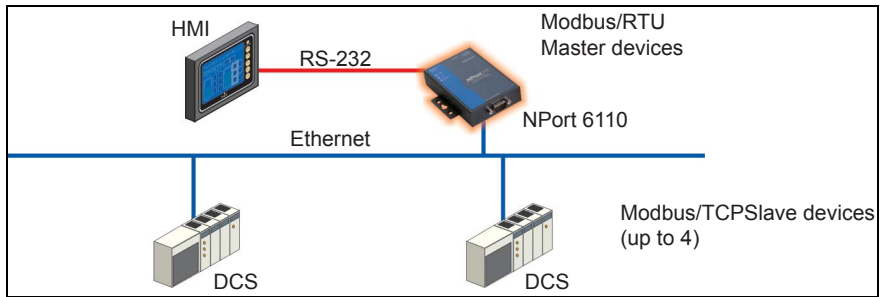

# Configuring Modbus Gateway

---

We discuss the following topics in this chapter:

- ❑ Starting Modbus Gateway Configurator
- ❑ Searching for NPort 6110
  - Broadcast Search
  - Specify by IP Address
- ❑ Modify Configuration
  - Network Settings
  - Modbus Settings
  - Advanced Modbus Settings
  - Modbus Serial Settings
  - Password
- ❑ Other Functions
  - Unlock
  - Upgrade Firmware
  - Remote Monitoring and Management
  - Start Log Monitor

# Starting Modbus Gateway Configurator

To start Modbus Gateway Configurator, click on **Start** → **Programs** → **NPort Modbus Gateway Utility** → **Modbus Gateway Configurator**.

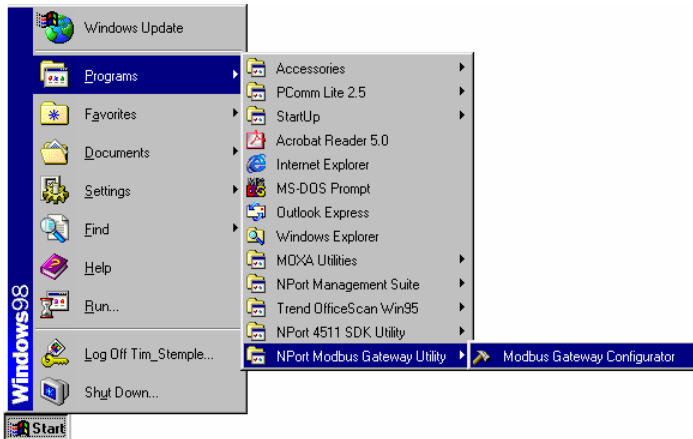

The **Modbus Gateway Configurator** window will open as shown below.

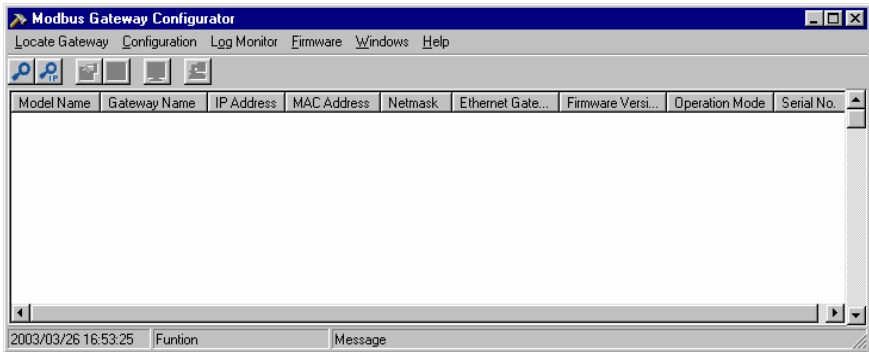

# Searching for NPort 6110

There are two methods available to search the network for NPort 6110s.

**Broadcast Search** is used to locate all NPort 6110s connected to the same LAN as the host, and **Search by IP** is used to locate a specific NPort 6110, particularly if it is located outside the LAN and can only be accessed by going through a router.

## Broadcast Search

To use the Broadcast Search function, click on the Broadcast Search icon from the toolbar, or select Broadcast Search under the **Locate Gateway** menu.

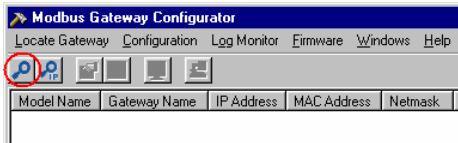

After the search is complete, information related to all NPort 6110s located on the LAN will be displayed in the Modbus Gateway Configurator window.

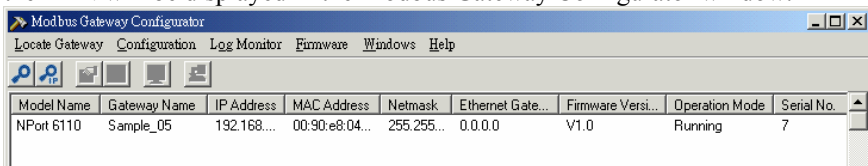

## Specify by IP Address

To use the Specify by IP Address function, click on the Specify by IP Address icon from the toolbar, or select Specify by IP Address under the **Locate Gateway** menu.

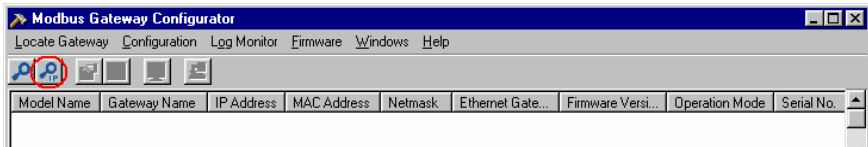



When the **Search by IP Address** window opens, input the IP address of the NPort 6110 you want to search for, and then click **OK**.

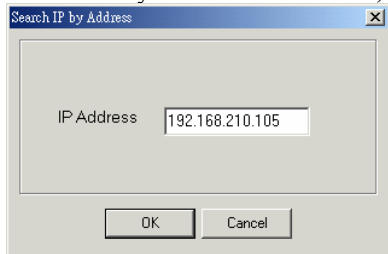

If the search is successful, information related to the NPort 6110 will be displayed in the Modbus Gateway Configurator window.

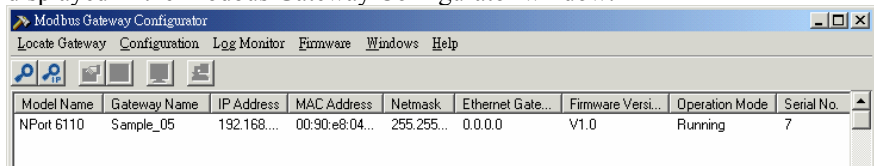

---

**NOTE** *If using the Search by IP Address function fails to locate the NPort 6110, one possible reason is that the IP address you entered to conduct the search is incorrect. Try retyping the IP address and then redo the search.*

*Another possibility is that the NPort 6110 is located on the same LAN as the host, but on a different subnet. In this case, you can change the IP address and/or Netmask of the host so that it is on the same subnet as the NPort 6110.*

---

## Modify Configuration

To modify the configuration of an NPort 6110, first click on the row associated with the NPort 6110 whose configuration you want to modify (to highlight the row, as shown in the following figure). Next, click on the **Modify Configuration** toolbar icon, or select Modify Configuration under the **Configuration** menu.

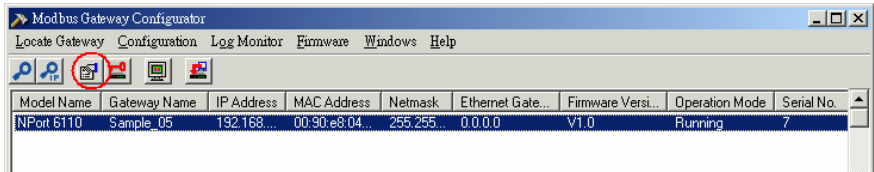

The **Configuration** window opens to the **Network Settings** page. Refer to the following subsections to learn more about how to configure NPort 6110's various settings.

## Network Settings

The **Network Settings** page is used to configure **Modbus Gateway Name**, **IP Address**, **Netmask**, **Default Gateway**, and **IP Configuration**. At the top of the page you may also view the **Model Name**, **MAC Address**, and **Serial Number** of the NPort 6110. These three parameters are set at the factory and cannot be modified by the user.

---

**NOTE** *To modify a setting, first checkmark the box to the left of the setting's name to activate the setting's text input box.*

---

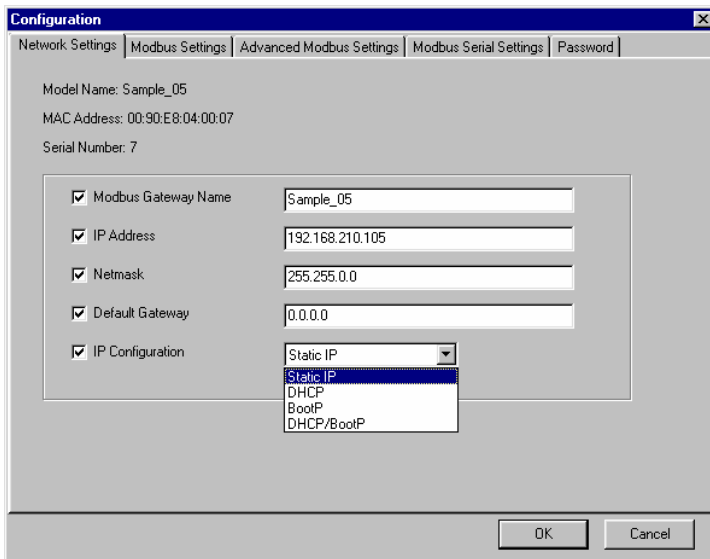

Network Settings		
Setting	Value	Notes
Modbus Gateway Name	<i>Alphanumeric</i>	Choose a name that easily identifies the Gateway's location, function, etc.
IP Address	32-bit number, default = 192.168.127.254	The IP (Internet Protocol) address identifies the server on the TCP/IP network.
Netmask	32-bit number, default = 255.255.255.0	Identifies the server as belonging to a Class A, B, or C network.
Default Gateway	32-bit number, default = 0.0.0.0	IP address of the router that provides network access outside the server's LAN.
IP Configuration	Choose from Static IP, DHCP, BootP, or DHCP/BootP.	<ol style="list-style-type: none"> <li>1. Choose Static IP if you are using a fixed IP address.</li> <li>2. Choose one of the other options if the IP address is set dynamically.</li> </ol>

## Modbus Settings

The Modbus Settings page is used to set up the **Attached Serial Device type**, **Initial delay time**, and **Modbus/TCP Slave device settings**.

---

**NOTE** *To modify the settings on this page, first checkmark the **Change Modbus Settings** box.*

*The **Modbus/TCP Slave device settings** are only active if the attached serial device is set as one of the two Master types.*

---

Choose the Modbus protocol of the attached serial device to determine the complementary Modbus protocol for the NPort 6110 Modbus Gateway. Four different types of serial Modbus device can be used. Since the Modbus protocol is used on a Master-Slave network, there are two steps to consider before starting the configuration process. The first step is to determine which devices are Masters and which are slaves (either Ethernet or Serial device). Next, you need to determine the Modbus protocol that the serial device uses.

**Configuration** [X]

Network Settings | Modbus Settings | **Advanced Modbus Settings** | Modbus Serial Settings | Password

Change Modbus Settings

Attached Serial Device type: Modbus RTU Master

Initial delay time: 100\_ (100 - 32726ms)

Modbus/TCP Slave device setting

Remote Modbus Slave IP	TCP Port No.	ID No. Range
192.168.210.101	502_	1_ — 10_
192.168.127.3	502_	11_ — 20_
192.168.127.4	502_	21_ — 30_
192.168.127.5	502_	31_ — 40_

OK Cancel

Modbus Settings		
Setting	Value	Notes
Attached Serial Device type	Modbus RTU Slave <sup>1</sup>	Set the Modbus type of the serial device attached to NPort 6110's serial port.
	Modbus ASCII Slave <sup>2</sup>	
	Modbus RTU Master <sup>3</sup>	
	Modbus ASCII Master <sup>4</sup>	
Initial delay time	100 to 3276 ms; default = 100 ms	NPort Modbus Gateway provides this setting for those PLCs that need a longer time for their system to be initialized.
Modbus/TCP Slave device setting		
Remote Modbus Slave IP	IP address assigned to the remote Modbus slave device.	Valid when the attached serial device is a Modbus RTU/ASCII Master.
TCP Port No.	default = 502	Set this value to 0 (zero) to disable the corresponding Modbus/TCP slave device.
ID No. Range	1 to 247	The unique Modbus ID number assigned to the Modbus device. <sup>5</sup>

### Additional Information

1. When the serial Modbus device is running in Modbus/RTU Slave mode, the NPort Modbus Gateway is ready to connect automatically to Modbus/TCP Master devices. Up to 7 Modbus/TCP master devices can connect to one serial Modbus slave device.
2. Modbus ASCII Slave mode works the same as Modbus/RTU slave mode, except that the data format is Modbus/ASCII.
3. When the serial Modbus device is running in Modbus/RTU Master mode, the NPort Modbus Gateway is ready to connect automatically to Modbus/TCP slave devices. You will also need to configure the IP address for up to 4 Modbus/TCP slave devices that can be connected to over the Ethernet network.

4. Modbus ASCII Master mode works the same as Modbus/RTU Master mode, except that the data format is Modbus/ASCII.
5. When the NPort Modbus Gateway receives a command from the serial port, the ID No. range table is used identify which IP address to connect to (e.g., if ID No. = 15, then according to the table in the Modbus Settings page shown above, the command is sent to the device that has IP of 192.168.127.3).

## Advanced Modbus Settings

The Advanced Modbus Settings page is used to set up the **Auto Slave Unit ID**, **Character Timeout**, **Message Timeout**, and **Modbus/TCP Exception**.

---

**NOTE** *To modify the settings on this page, you must first checkmark the **Change Modbus Settings** box at the top of the **Modbus Settings** page.*

---

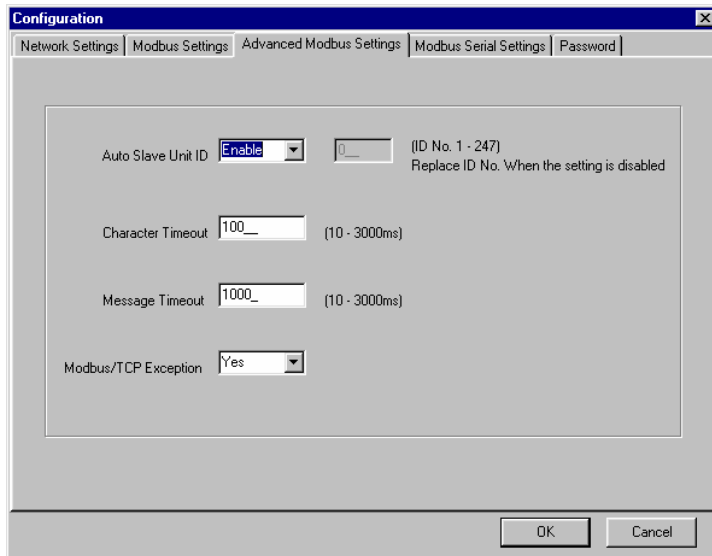

The screenshot shows a 'Configuration' dialog box with the 'Advanced Modbus Settings' tab selected. The dialog contains the following settings:

- Auto Slave Unit ID:** A dropdown menu set to 'Enable' and a text box containing '0'. To the right, it says '(ID No. 1 - 247)' and 'Replace ID No. When the setting is disabled'.
- Character Timeout:** A text box containing '100' and '(10 - 3000ms)'.
- Message Timeout:** A text box containing '1000' and '(10 - 3000ms)'.
- Modbus/TCP Exception:** A dropdown menu set to 'Yes'.

At the bottom right of the dialog are 'OK' and 'Cancel' buttons.

Advanced Modbus Settings		
Setting	Value	Notes
Auto Slave Unit ID	Enable (Default)	Select Enable when multiple Modbus devices are accessible at the same IP address. <sup>1</sup>
	Disable	
Character Timeout	10 to 3000 ms (default = 100 ms)	This parameter is active when the attached serial device is set to Modbus/RTU. <sup>2</sup>
Message Timeout	10 to 3000 ms (default = 1000 ms)	Allows you to configure the message timeout for communication between connected Ethernet or serial Modbus devices.
Modbus/TCP Exception	default = 502	This parameter is active when the Modbus Gateway connects a Modbus/TCP Master with Modbus serial slave devices. <sup>3</sup>

### Additional Information

1. Modbus/TCP protocol contains a “Unit ID” field to identify multiple Modbus slave devices accessible at a single IP address. When the Modbus/TCP command contains a Unit ID, the Modbus Gateway can pass the Unit ID to Modbus serial devices. This allows you to link to multiple serial devices with a Modbus Gateway. Some PLCs assume that each IP connects to only one device. In these cases, the Unit ID can be set “0,” but you must manually assign a Unit ID (between 1 and 247) to the connected serial device. However, each Modbus Gateway can connect to only one serial device.

This setting is valid when [Attached Serial Device type] is set to [Modbus RTU Slave ] or [Modbus ASCII Slave].

Enable: Uses the Unit ID in the Modbus/TCP packet. This is the default setting.

Disable: Uses the predefined Unit ID instead of Modbus/TCP’s.

ID: The predefined Unit ID value, ranging from 1 to 247, which is valid

when Auto Slave Unit ID is “Disabled.”

2. When the Modbus serial protocol is set to Modbus/RTU, each message packet is determined by a character timeout. An incorrect character timeout might cause a CRC checksum error. NPort Modbus Gateway allows a variable character time out setting, ranging from 10 to 3000 ms, when the attached serial device is set to Modbus/RTU.
3. This setting is in effect when the Modbus Gateway connects a Modbus/TCP Master with Modbus serial slave devices. When the Modbus Gateway can't get a response from Modbus serial devices, the Modbus serial protocol will not respond to the master device. However, the TCP protocol has a longer waiting time, which could cause a network traffic problem for Modbus/TCP. For this reason, Modbus Gateway can automatically send a Modbus Exception Code 16 to the Modbus/TCP master device when there is no response from the Modbus serial slave devices, making overall network communication much more efficient.

Yes: default.

No: No Modbus/TCP exception handling.



# Modbus Serial Settings

The Modbus Serial Settings page is used to configure NPort 6110's DB9 Male port. You can configure **Interface Mode**, **Baud Rate**, **Parity**, **Data Bits**, **Stop Bit**, **Flow Control**, and **UART FIFO**.

---

**NOTE** *To modify the settings on this page, you must first checkmark the **Change Modbus Settings** box at the top of the **Modbus Settings** page.*

---

The image shows a screenshot of a 'Configuration' dialog box with the 'Modbus Serial Settings' tab selected. The dialog has a title bar with a close button (X) and a tabbed interface with the following tabs: 'Network Settings', 'Modbus Settings', 'Advanced Modbus Settings', 'Modbus Serial Settings', and 'Password'. The 'Modbus Serial Settings' tab is active and contains the following settings for 'Port 1':

- Interface Mode: RS-232
- Baud Rate: 19200
- Parity: None
- Data Bits: 8
- Stop Bit: 1
- Flow Control: None
- UART FIFO: Enable

At the bottom of the dialog are 'OK' and 'Cancel' buttons.

Modbus Serial Settings		
Setting	Value	Notes
Interface Mode	RS-232	NPort 6110 supports 2-wire RS-485 mode.
	RS-422	
	RS-485	
Baud Rate	1200 bps to 230400 bps	
Parity	None, Odd, Even, Space, Mark	
Data Bits	7, 8	
Stop Bit	1, 2	
Flow Control	None, Xon/Xoff, RTS/CTS	
UART FIFO	Enable, Disable	

# Password

Use the Password page to set a password, change the password, or erase the password.

---

**NOTE** *To modify the settings on this page, you must first checkmark the **Change Password** box at the top of the **Password** page.*

*To erase an existing password, leave both the **New Password** and **Confirm Password** text input boxes blank, and then click **OK** in the bottom right corner of the window.*

---

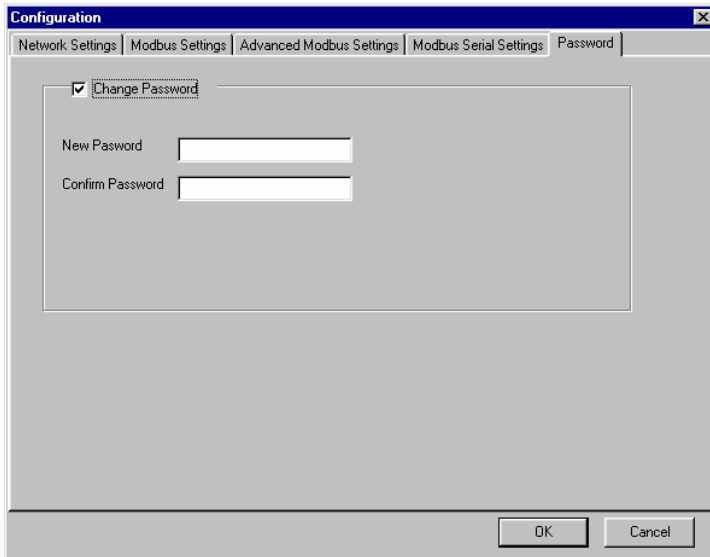

The image shows a screenshot of a software configuration window titled "Configuration". The window has a blue title bar and a tabbed interface. The tabs are "Network Settings", "Modbus Settings", "Advanced Modbus Settings", "Modbus Serial Settings", and "Password". The "Password" tab is currently selected. Inside the window, there is a checkbox labeled "Change Password" which is checked. Below the checkbox are two text input fields: "New Password" and "Confirm Password". At the bottom right of the window, there are two buttons: "OK" and "Cancel".

# Other Functions

The **Unlock**, **Start Log Monitor**, and **Upgrade Firmware** functions are described in this section.

## Unlock

The Unlock function is used for NPort 6110 units that are password protected. To use the function, first click on the NPort 6110 that you wish to unlock to highlight it, and then click on the Unlock toolbar icon, or select Unlock under the Configuration menu.

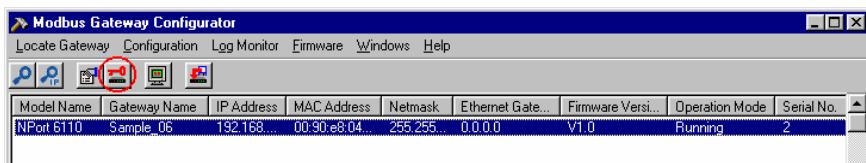

## Upgrade Firmware

Use the Upgrade Firmware function to upgrade NPort 6110's firmware, which can be downloaded from the Moxa website at [www.moxa.com](http://www.moxa.com).

To use this function, first click on the NPort 6110 whose firmware you want to download to highlight it, and then click on the Upgrade Firmware toolbar icon, or select Upgrade under the Firmware menu.

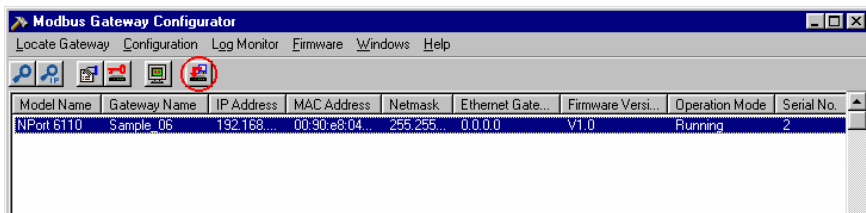

When the **Open** window appears, navigate to the folder that contains the NPort 6110 firmware file, and then click on the file name. Make sure the correct filename appears in the File name box, and then click on the **Open** button to start downloading the firmware.

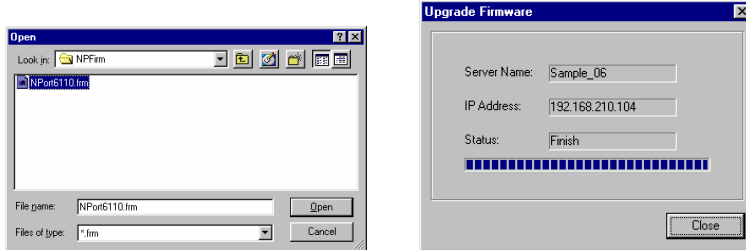

Once the downloading process ends, click on **Close** to close the Upgrade Firmware window. The **Broadcast Search** function will be activated automatically and search the LAN for all NPort 6110s.

# Remote Monitoring and Management

To troubleshoot and manage Modbus-based device connectivity, information such as TCP/IP, Modbus protocol type, and Master/Slave type are important. NPort Modbus Gateway provides a powerful function that allows you to monitor the operation of each Modbus Gateway on the Internet. The log monitor records detailed actions, such as operation modes, serial communication parameters, and TCP/IP connectivity for the NPort Modbus Gateway. These records include date/time and can be saved as a text file for maintenance or service record.

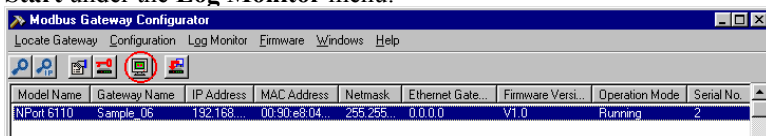

## Start Log Monitor

To start the Log Monitor, first click on the NPort 6110 you wish to monitor to highlight it, and then click on the **Start Log Monitor** toolbar icon, or select **Start** under the **Log Monitor** menu.

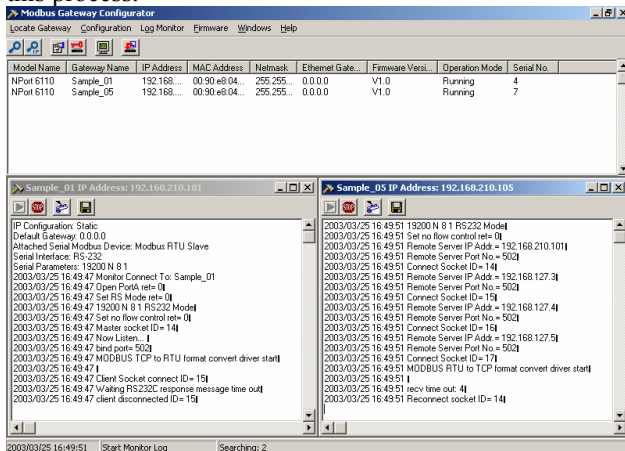

A Log Monitor window specific to the selected NPort 6110 will appear in the bottom half of the Modbus Gateway Configurator window. Note that you can open a separate Log Monitor window for other listed NPort 6110s by repeating this process.



To start capturing the operation log, press the **Start Log Monitor** button . The operation log appears with time stamp stating connection status for connected Modbus devices. To keep a record of this monitor session, save the log to a text file. To clear all the records, press the **Log Monitor Flush** button .

# Troubleshooting

---

In this chapter, we give answers to some common troubleshooting questions related to Modbus Gateway applications.

## 1. ID No. mismatch

ID number mismatch is the most common field installation problem encountered. First, make sure the ID number of each Modbus device corresponds to the settings in the automation software on the computer. Pay attention to Modbus Gateway's configuration to avoid ID number issues.

- 1.1 When [Attached Serial Device] is set to [Modbus/RTU Slave] or [Modbus/ASCII Slave], and the [Auto Slave Unit ID] is disabled, the Modbus Gateway will use a fixed ID number. Make sure the ID number of the serial device is identical to the settings in the Modbus Gateway.
- 1.2 When [Attached Serial Device] is set to [Modbus/RTU Master] or [Modbus/ASCII Master], the Modbus Gateway replies on [ID No. Range] to transfer the serial Modbus device command to the IP address of the correct Modbus/TCP device. The ID number in the Ethernet device and Modbus/TCP slave device setting table must match.

## 2. Modbus Address configuration error

Basically, Modbus Gateway will not change the Modbus address in the data packet of the protocol. When your automation software or device reports address error, check that the address setting on the device is correct.

## 3. Proper character timeout configuration for Modbus/RTU

A Modbus/RTU device requires character timeout for data packet segmentation. When a CRC error occurs, you may need to increase the character timeout in Modbus Gateway.

## 4. HMI polling time and timeout interval issue

When [Attached Serial Device] is set to [Modbus/RTU Slave] or [Modbus/ASCII Slave], each Modbus Gateway accepts up to 7 connections from Modbus/TCP master devices. However, the Ethernet speed is much higher than the Serial speed. Therefore, proper polling time and timeout interval settings are required to prevent timeout error. For a particular HMI monitoring system, the best configuration is: polling time set to 0.5 – 1.0 sec, Timeout interval 3 sec.



# 6

## Pin Assignments

---

NPort 6110 supports three serial interfaces: RS-232, RS-422, and 2-wire RS-485. In this chapter, we give the DB9 Male pinouts for each of these three interfaces.

### DB9 Male Pinouts

Pin No.	RS-232	RS-422	RS-485
1	DCD	TxD-(A)	Data-(A)
2	RxD	TxD+(B)	Data+(B)
3	TxD	RxD+(B)	---
4	DTR	RxD-(A)	---
5	GND	GND	GND
6	DSR	RTS-(A)	---
7	RTS	RTS+(B)	---
8	CTS	CTS+(B)	---
9	---	CTS-(A)	---

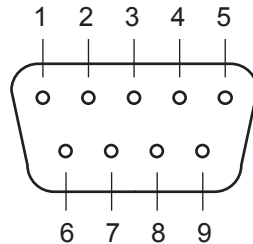

## Declaration of Conformity

---

Manufacturer's Name: Moxa Technologies Co., Ltd.  
Manufacturer's Address: Fl.4, No.135, Lane 235, Pao-Chiao Rd., Shing Tien City, Taipei, Taiwan, R.O.C.

declares that the product:

Product Name: Modbus Gateway  
Model Number: NPort 6110

conforms to the following standards:

EMC: FCC Class B  
EN55022:1998 class B  
EN61000-3-2:1995 class B  
EN61000-3-3:1995  
EN55082-1:1997  
EN61000-4-2:1995  
Contact Discharge 4kV, Air Discharge 8kV  
EN61000-4-3:1995  
EN61000-4-4:1995  
AC/DC Power supply 1kV, Data/Signal lines 5kV  
EN61000-4-5:1995  
AC/DC Line to Line 1kV, AC/DC Line to Earth 2kV  
EN61000-4-6:1995  
EN61000-4-8:1993  
3A/m at 50Hz  
EN61000-4-11:1994  
Safety UL/CUL, TUV  
EN60950

## Problem Report Form

### NPort 6110 Modbus Gateway

<b>Customer name:</b>	
Company:	
Tel:	Fax:
Email:	Date:

1. Moxa Product:  NPort 6110 (1 RS-232/422/485 port)
2. Interface:  RS-232  RS-422  RS-485 (2-wire)
3. Attached serial device type:  
 Modbus/ASCII       Master       Slave  
 Modbus/RTU       Master       Slave
4. Serial Number: \_\_\_\_\_
5. Firmware Version: \_\_\_\_\_
6. Modbus Configurator Version: \_\_\_\_\_
7. Problem Description: Please describe the symptoms as clearly as possible, including all error messages. Be complete, since we may need to follow your description to reproduce the symptoms.

# RETURN PROCEDURE

For product repair, exchange, or refund, the customer must:

- ◆ Provide evidence of original purchase.
- ◆ Obtain a Product Return Agreement (PRA) from the sales representative or dealer.
- ◆ Fill out the Problem Report Form (PRF). Include as much detail as possible for a shorter product repair time.
- ◆ Carefully pack the product in an anti-static package, and send it, pre-paid, to the dealer. The PRA should be visible on the outside of the package, and include a description of the problem, along with the return address and telephone number of a technical contact.