

YAMAHA DIGITAL SOUND FIELD PROCESSING AMPLIFIER

DSP-A780

OPERATION MANUAL

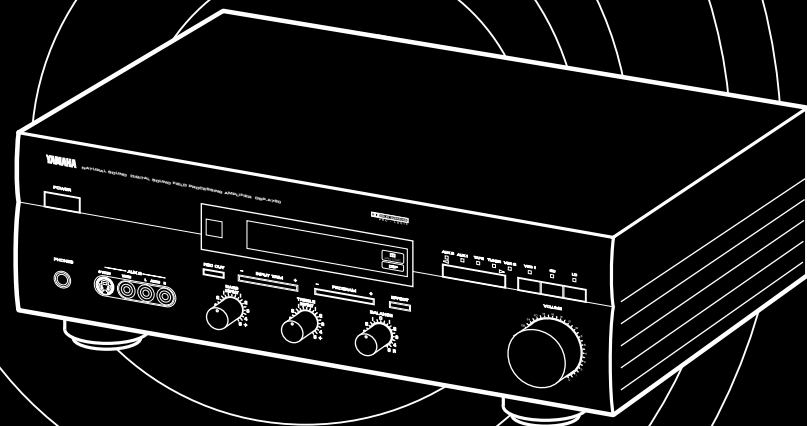

CONTENTS

PRECAUTIONS & SAFETY INSTRUCTIONS	Inside Front Cover
SETUP & ADJUSTMENT	3
1-1. GETTING STARTED	3
1-2. SETUP	8
1-3. CONTROLS & ADJUSTMENTS	16
1-4. ADJUSTMENT	20
GENERAL OPERATION	24
2-1. PLAYING A SOURCE	24
2-2. RECORDING A SOURCE TO AUDIO/VIDEO TAPE (OR DUBBING FROM A TAPE TO ANOTHER)	25
2-3. DIGITAL SOUND FIELD PROGRAMS	28
2-4. SELECTING SOUND FIELD PROGRAMS	28
2-5. MUTING THE EFFECT SOUND	28
2-6. SUPERIMPOSED VIDEO PROGRAM/PARAMETER DISPLAY	28
2-7. DESCRIPTIONS OF THE SOUND FIELD PROGRAMS	29
CREATING YOUR OWN SOUND FIELDS	33
3-1. SELECTING AND EDITING PROGRAM PARAMETERS	33
3-2. DESCRIPTIONS OF THE DIGITAL SOUND FIELD PARAMETERS	35
TROUBLESHOOTING	37
SPECIFICATIONS	38

PRECAUTIONS & SAFETY INSTRUCTIONS

SAFETY INSTRUCTIONS

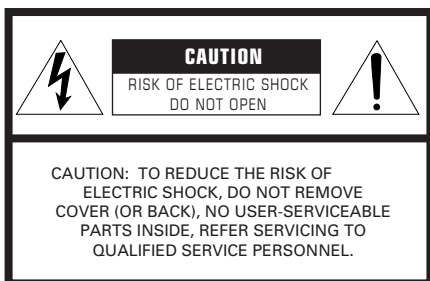

- Explanation of Graphical Symbols



The lightning flash with arrowhead symbol, within an equilateral triangle, is intended to alert you to the presence of uninsulated "dangerous voltage" within the product's enclosure that may be of sufficient magnitude to constitute a risk of electric shock to persons.



The exclamation point within an equilateral triangle is intended to alert you to the presence of important operating and maintenance (servicing) instructions in the literature accompanying the appliance.

WARNING

TO REDUCE THE RISK OF FIRE OR ELECTRIC SHOCK, DO NOT EXPOSE THIS UNIT TO RAIN OR MOISTURE.

IMPORTANT!

Please record the serial number of this unit in the space below.

Model:
Serial No.:

The serial number is located on the rear of the unit.
Retain this Owner's Manual in a safe place for future reference.

1 Read Instructions – All the safety and operating instructions should be read before the unit is operated.

2 Retain Instructions – The safety and operating instructions should be retained for future reference.

3 Heed Warnings – All warnings on the unit and in the operating instructions should be adhered to.

4 Follow Instructions – All operating and other instructions should be followed.

5 Water and Moisture – The unit should not be used near water – for example, near a bathtub, washbowl, kitchen sink, laundry tub, in a wet basement, or near a swimming pool, etc.

6 Carts and Stands – The unit should be used only with a cart or stand that is recommended by the manufacturer.

6A A unit and cart combination should be moved with care. Quick stops, excessive force, and uneven surfaces may cause the unit and cart combination to overturn.



7 Wall or Ceiling Mounting – The unit should be mounted to a wall or ceiling only as recommended by the manufacturer.

8 Ventilation – The unit should be situated so that its location or position does not interfere with its proper ventilation. For example, the unit should not be situated on a bed, sofa, rug, or similar surface, that may block the ventilation openings; or placed in a built-in installation, such as a bookcase or cabinet that may impede the flow of air through the ventilation openings.

9 Heat – The unit should be situated away from heat sources such as radiators, stoves, or other appliances that produce heat.

10 Power Sources – The unit should be connected to a power supply only of the type described in the operating instructions or as marked on the unit.

11 Power-Cord Protection – Power-supply cords should be routed so that they are not likely to be walked on or pinched by items placed upon or against them, paying particular attention to cords at plugs, convenience receptacles, and the point where they exit from the unit.

12 Cleaning – The unit should be cleaned only as recommended by the manufacturer.

13 Nonuse Periods – The power cord of the unit should be unplugged from the outlet when left unused for a long period of time.

14 Object and Liquid Entry – Care should be taken so that objects do not fall into and liquids are not spilled into the inside of the unit.

15 Damage Requiring Service – The unit should be serviced by qualified service personnel when:

- A. The power-supply cord or the plug has been damaged;
- or
- B. Objects have fallen, or liquid has been spilled into the unit;
- or
- C. The unit has been exposed to rain;
- or
- D. The unit does not appear to operate normally or exhibits a marked change in performance;
- or
- E. The unit has been dropped, or the cabinet damaged.

16 Servicing – The user should not attempt to service the unit beyond those means described in the operating instructions. All other servicing should be referred to qualified service personnel.

17 Power Lines – An outdoor antenna should be located away from power lines.

18 Grounding or Polarization – Precautions should be taken so that the grounding or polarization is not defeated.

PRECAUTIONS

- 1 To ensure the finest performance, please read this manual carefully. Keep it in a safe place for future reference.
- 2 Install your unit in a cool, dry, clean place – away from windows, heat sources, and too much vibration, dust, moisture or cold. Avoid sources of hum (transformers, motors). To prevent fire or electrical shock, do not expose to rain and water.
- 3 Do not operate the unit upside-down. It may overheat, possibly causing damage.
- 4 Never open the cabinet. If a foreign object drops into the set, contact your dealer.
- 5 Do not use force on switches, knobs or cords. When moving the set, first turn the unit off. Then gently disconnect the power plug and the cords connecting to other equipment. Never pull the cord itself.
- 6 Do not attempt to clean the unit with chemical solvents; this might damage the finish. Use a clean, dry cloth.
- 7 Always set the volume control to “∞” while lowering the tonearm to play a record; turn the volume up with the stylus in the groove.
- 8 Be sure to read the “Troubleshooting” section on common operating errors before concluding that your unit is faulty.
- 9 Do not connect audio equipment to the AC outlets on the rear panel if that equipment requires more power than the outlets are rated to provide.

We Want You Listening For A Lifetime

YAMAHA and the Electronic Industries Association's Consumer Electronics Group want you to get the most out of your equipment by playing it at a safe level. One that lets the sound come through loud and clear without annoying blaring or distortion – and, most importantly, without affecting your sensitive hearing. Since hearing damage from loud sounds is often undetectable until it is too late, YAMAHA and the Electronic Industries Association's Consumer Electronics Group recommend you to avoid prolonged exposure from excessive volume levels.



FCC INFORMATION

1. IMPORTANT NOTICE : DO NOT MODIFY THIS UNIT!

This product, when installed as indicated in the instructions contained in this manual, meets FCC requirements. Modifications not expressly approved by Yamaha may void your authority, granted by the FCC, to use the product.

2. **IMPORTANT** : When connecting this product to accessories and/or another product use only high quality shielded cables. Cable/s supplied with this product **MUST** be used. Follow all installation instructions. Failure to follow instructions could void your FCC authorization to use this product in the USA.

3. **NOTE** : This product has been tested and found to comply with the requirements listed in FCC Regulations, Part 15 for Class “B” digital devices. Compliance with these requirements provides a reasonable level of assurance that your use of this product in a residential environment will not result in harmful interference with other electronic devices.

This equipment generates/uses radio frequencies and, if not installed and used according to the instructions found in the users manual, may cause interference harmful to the operation of other electronic devices.

Compliance with FCC regulations does not guarantee that interference will not occur in all installations. If this product is found to be the source of interference, which can be determined by turning the unit “OFF” and “ON”, please try to eliminate the problem by using one of the following measures:

Relocate either this product or the device that is being affected by the interference.

Utilize power outlets that are on different branch (circuit breaker or fuse) circuits or install AC line filter/s.

In the case of radio or TV interference, relocate/reorient the antenna. If the antenna lead-in is 300 ohm ribbon lead, change the lead-in to coaxial type cable.

If these corrective measures do not produce satisfactory results, please contact the local retailer authorized to distribute this type of product. If you can not locate the appropriate retailer, please contact Yamaha Electronics Corp., U.S.A. 6660 Orangethorpe Ave, Buena Park, CA 90620.

The above statements apply **ONLY** to those products distributed by Yamaha Corporation of America or its subsidiaries.

Congratulations!

You are the proud owner of a Yamaha Digital Sound Field Processing (DSP) System—an extremely sophisticated audio component. The DSP system takes full advantage of Yamaha's undisputed leadership in the field of digital audio processing to bring you a whole new world of listening experiences. Follow the instructions in this manual carefully when setting up your system, and the DSP system will sonically transform your room into a wide range of listening environments—anything from a famous concert hall to a cozy jazz club. In addition, you get incredible realism from Dolby-Surround encoded video sources using the built-in Dolby Pro Logic Surround Decoder.

Rather than tell you about the wonders of digital sound field processing, however, let's get right down to the business of setting up the system and trying out its many capabilities. Please read this operation manual carefully and store it in a safe place for later reference.

SETUP & ADJUSTMENT

1-1. GETTING STARTED

Unpacking

If you haven't already done so, carefully remove this unit and its accessories from the box and wrapping material. You should find the unit itself and the following accessories.

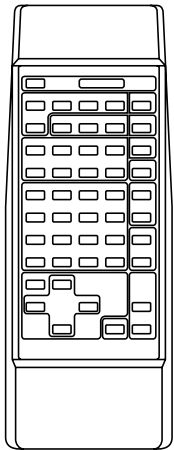

Remote control

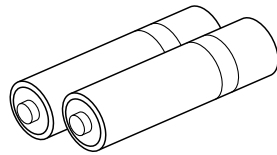

Batteries

Installing the Remote Control Unit Batteries

Since the remote control unit will be used for many of this unit's control operations, you should begin by installing the supplied batteries.

1. Turn the remote control unit over, and remove the battery compartment cover by pulling it in the direction of the white arrow on the figure shown below.
2. Insert the batteries (R6, AA, UM-3 type), being careful to align them with the polarity markings on the inside of the battery compartment.
3. Close the battery compartment cover.

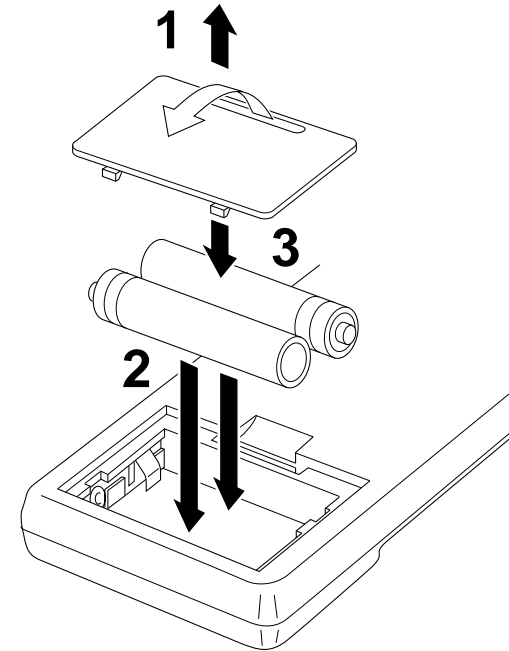

- When you notice that remote control operation has become erratic, or the distance from which the remote control will function has decreased, it's time to replace the batteries. Always replace all batteries at the same time.
- This remote control uses an advanced, highly directional infrared beam. Be sure to aim the remote control directly at the remote control sensor on the main unit when operating.

Remote control transmitter operation range

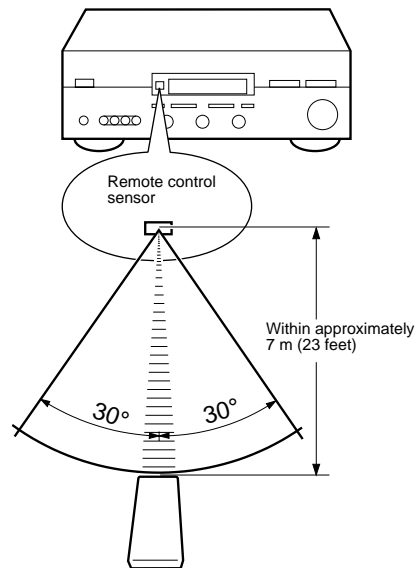

Notes

- There should be no large obstacles between the remote control transmitter and the main unit.
- If the remote control sensor is directly illuminated by strong lighting (especially an inverter type of fluorescent lamp etc.), it might cause the remote control transmitter to work incorrectly. In this case, reposition the main unit to avoid direct lighting.

Digital Sound Field Processing

What is it that makes live music so good? Today's advanced sound reproduction technology lets you get extremely close to the sound of a live performance, but chances are you'll still notice something missing, the acoustic environment of the live concert hall. Extensive research into the exact nature of the sonic reflections that create the ambience of a large hall has made it possible for Yamaha engineers to bring you this same sound in your own listening room, so you'll feel all the sound of a live concert. What's more, our technicians, armed with sophisticated measuring equipment, have even made it possible to capture the acoustics of a variety of actual concert halls, jazz clubs, theaters, etc. from around the world, to allow you to accurately recreate any one of these live performance environments, all in your own home.

Dolby Pro Logic Surround

The Dolby Pro Logic Surround Decoder program lets you experience the dramatic realism and impact of Dolby Surround movie theater sound in your own home. Dolby Pro Logic gets its name from its professional-grade steering logic circuitry, which provides greater effective channel separation for a much higher degree of realism than the "passive" Dolby Surround circuits found in today's typical home audio/video equipment. Dolby Pro Logic Surround provides a true center channel, so that there are four independent channels, unlike passive Dolby Surround, which has in effect only three channels: left, right, and rear. This center channel allows listeners seated in even less-than-ideal positions to hear the dialog originating from the action on the screen while experiencing good stereo imaging.

This Dolby Pro Logic Surround Decoder employs a digital signal processing system. This system improves the stability of sound at each channel and crosstalk between channels, so that positioning of sounds around the room is more accurate compared with conventional analog signal processing systems.

In addition, this unit features a built-in automatic input balance control. This always assures you the best performance without manual adjustment.

Manufactured under license from Dolby Laboratories Licensing Corporation. Additionally licensed under Canadian patent number 1,037,877. "Dolby", "Pro Logic", and the double-D symbol are trademarks of Dolby Laboratories Licensing Corporation.

Dolby Pro Logic Surround + DSP

Additionally you can enjoy sound environment created by the combination of Dolby Pro Logic and YAMAHA DSP. Precise sound movement and orientation by the Dolby Pro Logic technology is added to sound fields which are precisely recreated on the basis of actual acoustic environments by the DSP technology, so it is suitable for any Audio/Video source with video image. This combination is used on sound field programs No. 5 through No. 14, and No. 16.



The YAMAHA "CINEMA DSP" logo indicates these programs created by the combination of Dolby Pro Logic and YAMAHA DSP technology.

VIDEO SUPERIMPOSE

If you connect your video cassette recorder, video disc player, video monitor, etc. to this unit, you can take advantage of this unit's capability to display program titles, parameter data and information about other various settings and adjustments on your video monitor's screen. This information will be superimposed over the video image.

If there is no video source connected or it is turned off, the information will be displayed over a blue colored background.

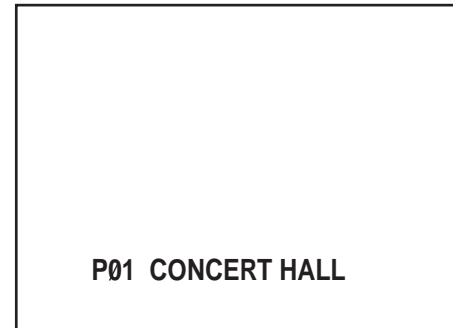

NOTE: The program titles, parameter data and other information are also displayed on the display panel of this unit.



Setting Up Your Speaker System

This unit has been designed to provide the best sound field quality with a full five-speaker system setup, using one extra pairs of effect speakers to generate the sound field plus one center speaker for dialog, when using Dolby Pro Logic Surround decoding. We therefore recommend that you use a five-speaker setup. A four-speaker system using only one pair of effect speakers for the sound field will still provide impressive ambience and effects, however, and may be a good way to begin with this unit. You can always upgrade to the full five speaker system later.

Use of the Center Dialog Speaker Is Recommended

With digital sound field programs No. 5 through No. 16, by using either the Directional Enhancement circuit or the Dolby Pro Logic decoder, decoded signals will be output from the center channel. Therefore, if you want to upgrade the Audio/Video home theater system, it is recommended to use the center speaker unit.

If for some reason it is not practical to use a center speaker, it is possible to enjoy movie viewing without it. Best results, however, are obtained with the full system.

It is also possible to further expand your system with the addition of a subwoofer and amplifier. You may wish to choose the convenience of a Yamaha Active Servo Processing Subwoofer System, which has its own built-in power amp.

5 Speaker System

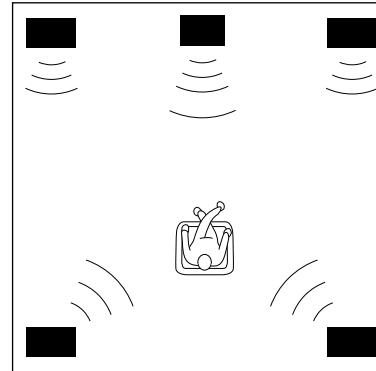

This is the recommended speaker system, providing the best sound effects.

With sound field programs No. 1 through No. 4, using effect speakers reproduces the effective sound field. With the sound field programs No. 5 through No. 16, the center speaker provides precise center localization.

**Center Mode—Set to NRML or WD.
(See page 22.)**

4 Speaker System

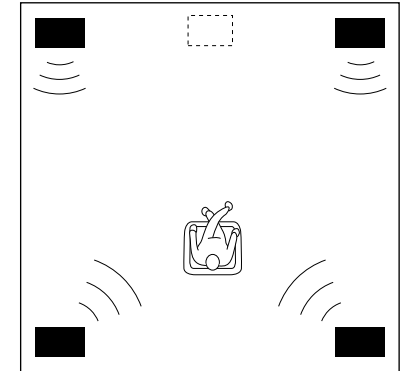

Simple system without center speaker.

With sound field programs No. 1 through No. 4, a sound effect matching that of a 5-speaker system can be obtained. With sound field programs No. 5 through No. 16, center sound is output from the left and right main speakers.

**Center Mode—Set to PHNTM.
(See page 22.)**

Speakers and Speaker Placement

Your full five-speaker system will require two speaker pairs: the MAIN SPEAKERS (your normal stereo speakers) and the REAR EFFECT SPEAKERS, plus the CENTER SPEAKER. You may also be using a subwoofer.

You will probably use your present stereo speakers as the MAIN SPEAKER pair. The rear effect do not need to be equal with the MAIN SPEAKERS, although the center speaker should be as close as possible. They should have enough power handling capacity to accept the maximum output of the DSP system.

Place the MAIN SPEAKERS in the normal position.

Place the REAR EFFECT SPEAKERS behind your listening position. They should be nearly six feet up from the floor.

Place the CENTER SPEAKER precisely between the two MAIN SPEAKERS. (To avoid interference, keep the speaker above or below the television monitor, or use a magnetically shielded speaker.)

If using a SUBWOOFER, such as a Yamaha Active Servo Subwoofer System, the position of the speaker is not so critical because low bass tones are not highly directional.

NOTE: The Yamaha NS-C110 speaker, available in some countries, is an ideal choice for the center speaker.

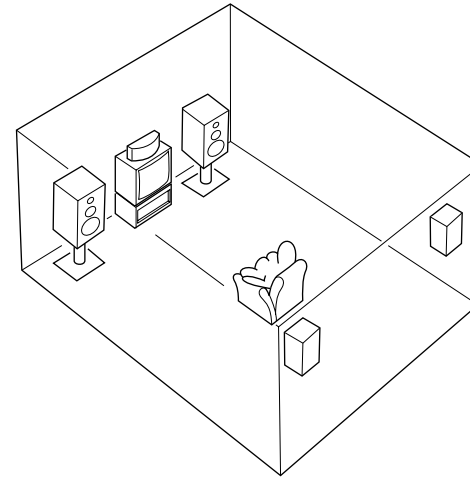

Main speaker



Rear effect speaker



Center speaker

1-2. SETUP

Before you start making connections make sure all related electronic components are turned OFF.

REAR PANEL

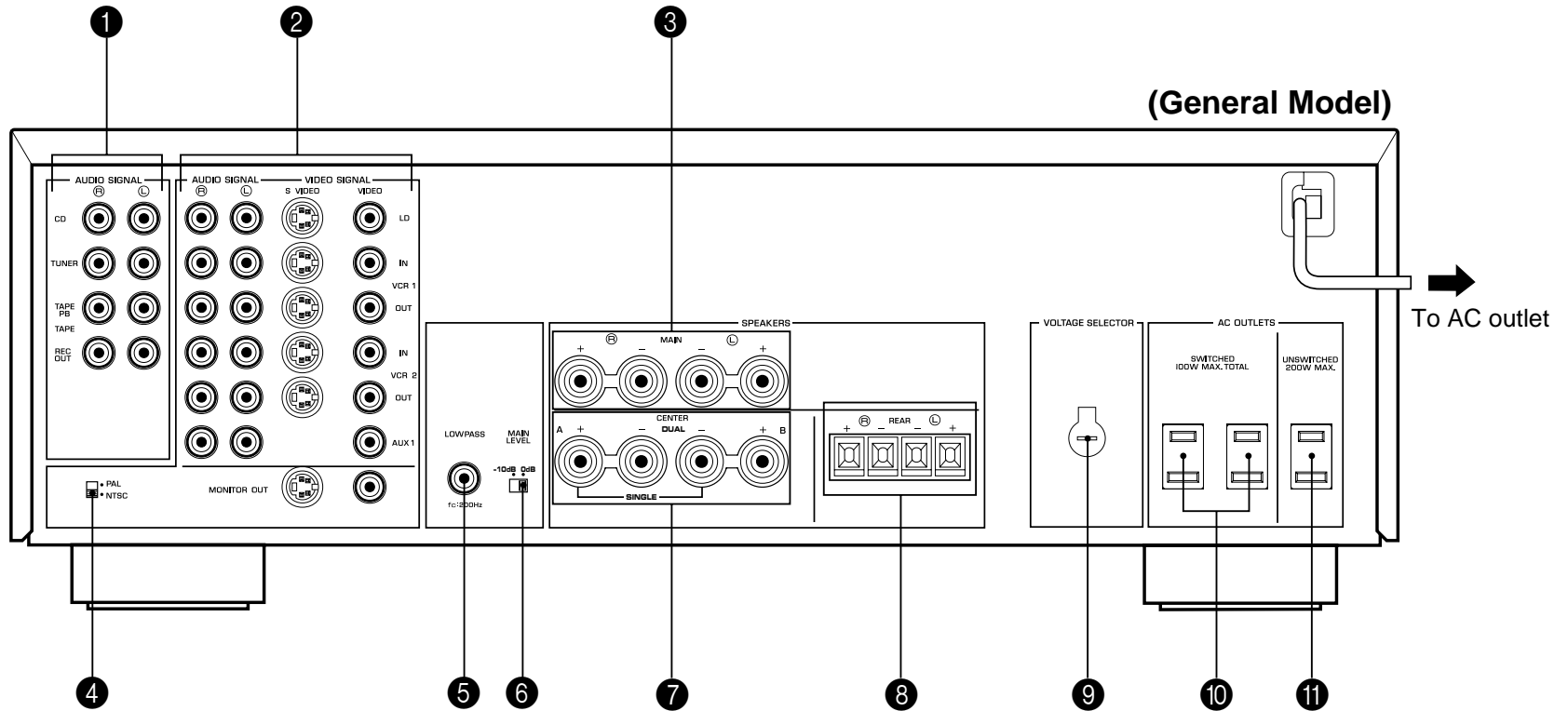

- ① **Audio Signal Connection Jacks (for Audio Source Equipment)**
Connect the inputs and/or outputs of your audio equipment.
- ② **Audio/Video Signal Connection Jacks (for Video Source Equipment)**
Connect the audio and video inputs and/or outputs of your video equipment. In place of the VIDEO jacks, the S VIDEO jacks can be used for higher resolution and improved picture quality if your VCR, monitor, etc. are equipped with S-VIDEO connectors.
- ③ **Main Speaker Terminals**
Connect the main speakers here.
- ④ **Video NTSC/PAL Switch (General Model only)**
Set this switch to the position corresponding to the standard that your video equipment employs.
- ⑤ **Low Pass Jack**
When using a subwoofer, connect its amplifier input to this jack. Frequencies below 200 Hz from the left main, right main and center channels are output to this jack.
- ⑥ **Main Level Switch**
Normally set to "0 dB". If desired, you can decrease the main-channel output level at the MAIN speaker terminals by 10 dB by setting this switch to "-10 dB".
- ⑦ **Center Speaker Terminals**
Connect one or two center speakers here.
- ⑧ **Rear Effect Speaker Terminals**
Connect the rear effect speakers here.
- ⑨ **Voltage Selector (General Model only)**
Be sure to set to the line voltage in your area before applying power. Consult your dealer if unsure of the correct setting.
- ⑩ **Switched AC Outlets**
You may plug other audio components into these sockets as long as their combined power consumption does not exceed the specified value shown. "Switched" means that these components are turned on and off by this unit's power switch.
- ⑪ **Unswitched AC Outlet (U.S.A., Canada and General Models)**
The total power consumption of audio components plugged into this socket should not exceed the specified value shown. "Unswitched" means that power is available even when this unit is off.

GENERAL INSTRUCTIONS FOR CONNECTIONS

Make sure that you have the left (L) and right (R) channels correctly connected. That means that jacks marked “L” on this unit must be connected to jacks marked “L” on other units. Likewise with the “R” jacks. This is easy if you remember to always use the red plug for the “R” jacks and the other plugs for the “L” jacks.

With speaker connections you must also be sure that the polarity is correct. For each amplifier and each channel, connect the plus (+) terminal of the amplifier to the plus terminal of the speaker, and connect the minus (–) terminal of the amplifier to the minus terminal of the speaker. To keep track of polarity, use a speaker cable that has one of the two wires marked by a stripe or a different color.

CONNECTING AUDIO/VIDEO SOURCE EQUIPMENT TO THIS UNIT

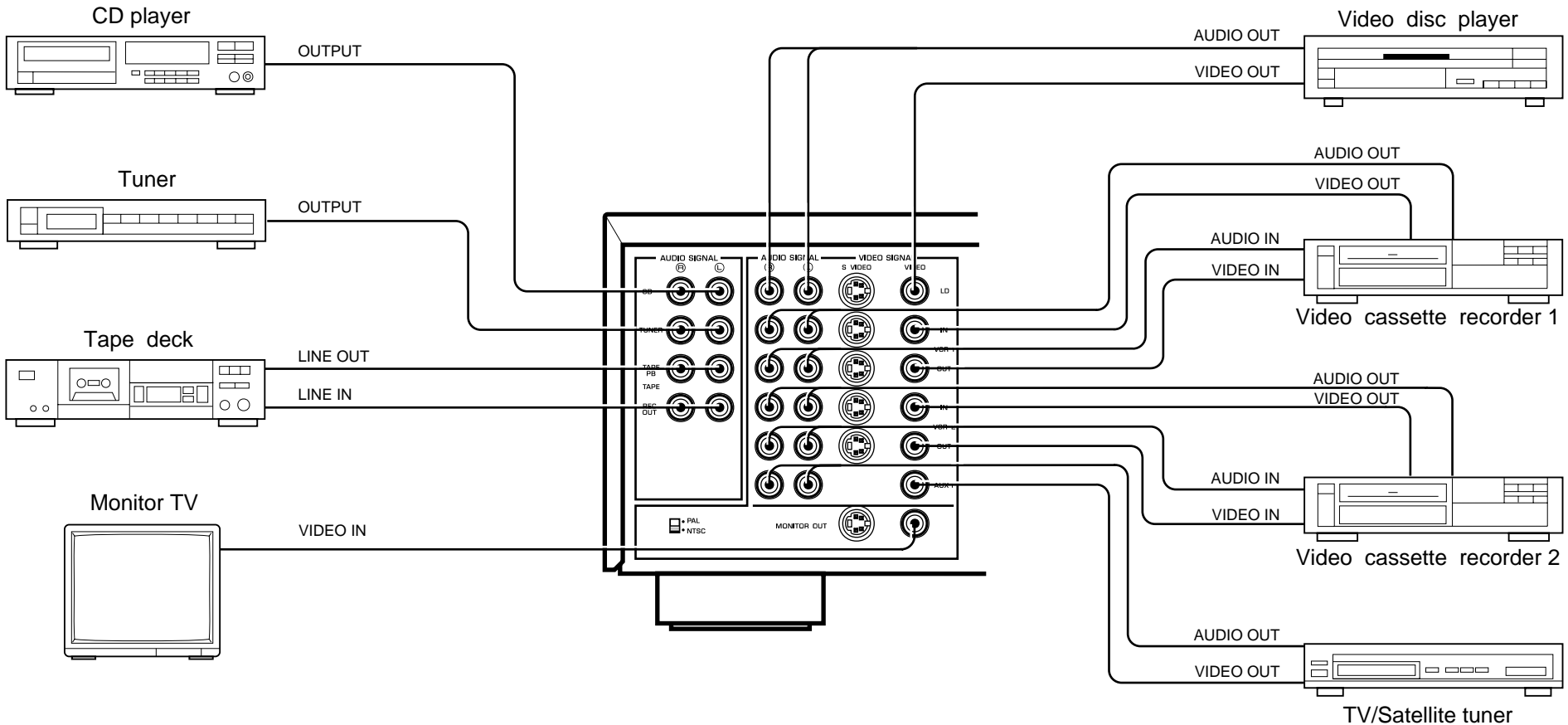

CONNECTING TO S VIDEO JACKS

If your video cassette recorder, video disc player, etc. and your monitor are equipped with “S” (high-resolution) video terminals, connect them to this unit’s S VIDEO jacks, and connect this unit’s S VIDEO MONITOR OUT jack to the “S” video input of your monitor. Otherwise, connect the composite video jacks from your video cassette recorder, video disc player, etc. to the VIDEO jacks of this unit, and connect this unit’s VIDEO MONITOR OUT jack to the composite video input of your monitor.

NOTE: If video signals are sent to both S VIDEO input and VIDEO input jacks, the signals will be sent to their respective output jacks independently.

NOTE: If your unit is the General Model, be sure the NTSC/PAL switch has been correctly set to the standard that your video equipment employs. U.S.A. and Canada models have no switch and use the NTSC standard, while other models without a switch use the PAL standard.

Notes about the Video superimpose

- If you watch a video source that is connected to both S VIDEO and VIDEO input jacks of this unit, signals of screen display information are output from only the S VIDEO MONITOR OUT jack.
- When no video signal is input to either S VIDEO or VIDEO input jacks of this unit, signals of screen display information are output from both S VIDEO MONITOR OUT and VIDEO MONITOR OUT jacks with a color background.
 - * For the General Model, if the NTSC/PAL switch on the rear panel is set to “PAL”, nothing will be output from either S VIDEO MONITOR OUT or VIDEO MONITOR OUT jack in this case.

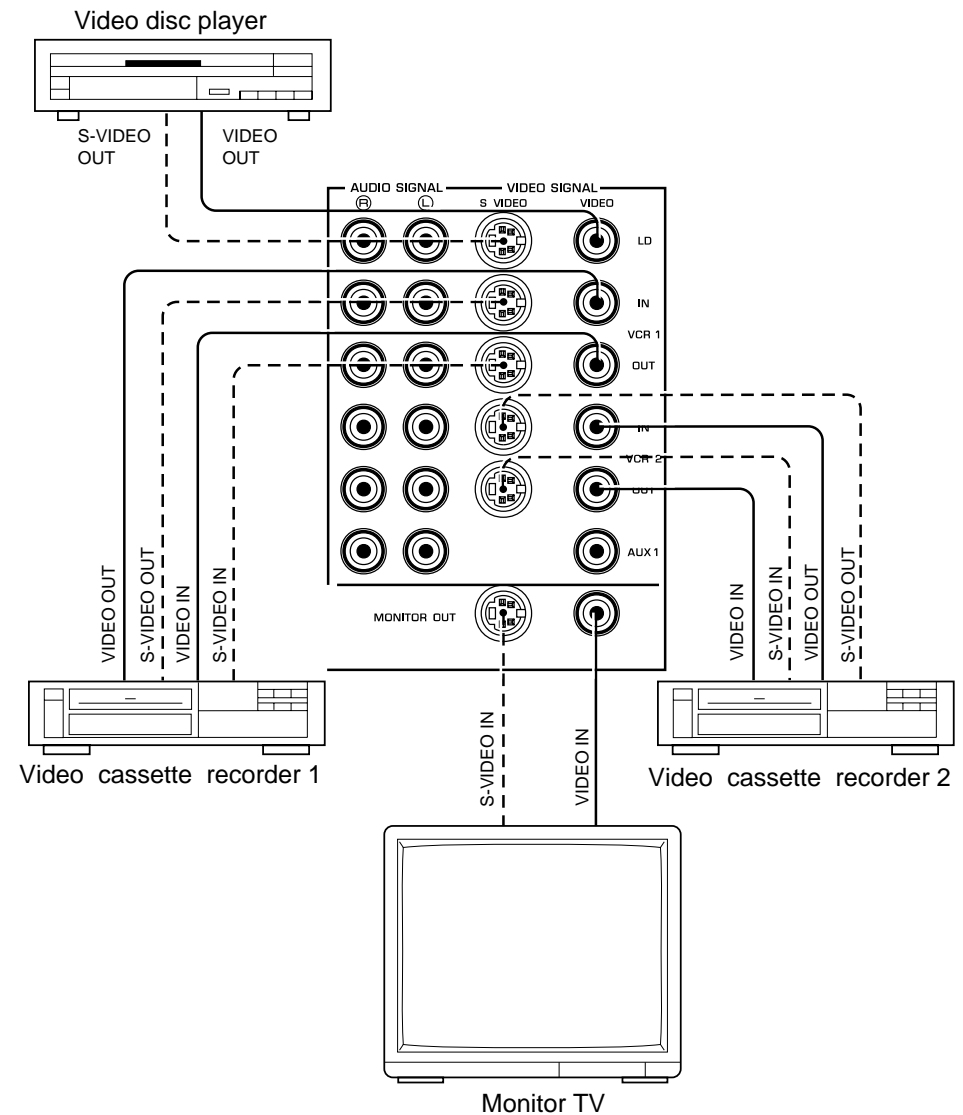

CONNECTING SPEAKER SYSTEMS

Connect the SPEAKERS terminals to your speakers with wire of the proper gauge, cut as short as possible. If the connections are faulty, no sound will be heard from the speakers. Make sure that the polarity of the speaker wires is correct, that is, + and – markings are observed. If these wires are reversed, the sound will be unnatural and will lack bass. Do not let the bare speaker wires touch each other or any other metal part as this could damage this unit and/or speakers.

NOTE: Use speakers with the specified impedance shown on the rear of this unit.

For connecting to the MAIN and CENTER SPEAKERS terminals.

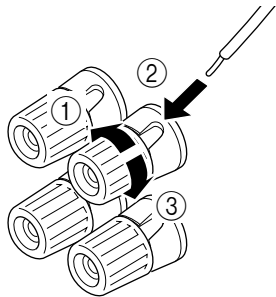

Red: positive (+)
Black: negative (-)

- ① Unscrew the knob.
- ② Insert the bare wire.
[Remove approx. 5mm (1/4") insulation from the speaker wires.]
- ③ Tighten the knob and secure the wire.

NOTE: Banana Plug connections are also possible (except for Scandinavian models). Simply insert the Banana Plug connector into the corresponding terminal.

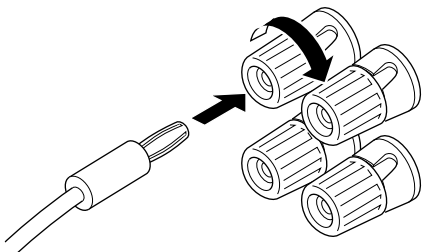

For connecting to the REAR SPEAKERS terminals.

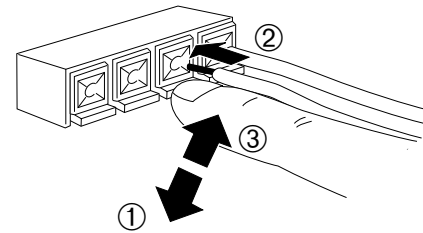

Red: positive (+)
Black: negative (-)

- ① Press down the tab.
- ② Insert the bare wire.
[Remove approx. 5mm (1/4") insulation from the speaker wires.]
- ③ Press up the tab and secure the wire.

CONNECTING THE MAIN SPEAKERS AND THE REAR EFFECT SPEAKERS TO THIS UNIT

Connect the MAIN speakers to the MAIN SPEAKERS terminals of this unit.

Connect the REAR effect speakers to the REAR SPEAKERS terminals of this unit.

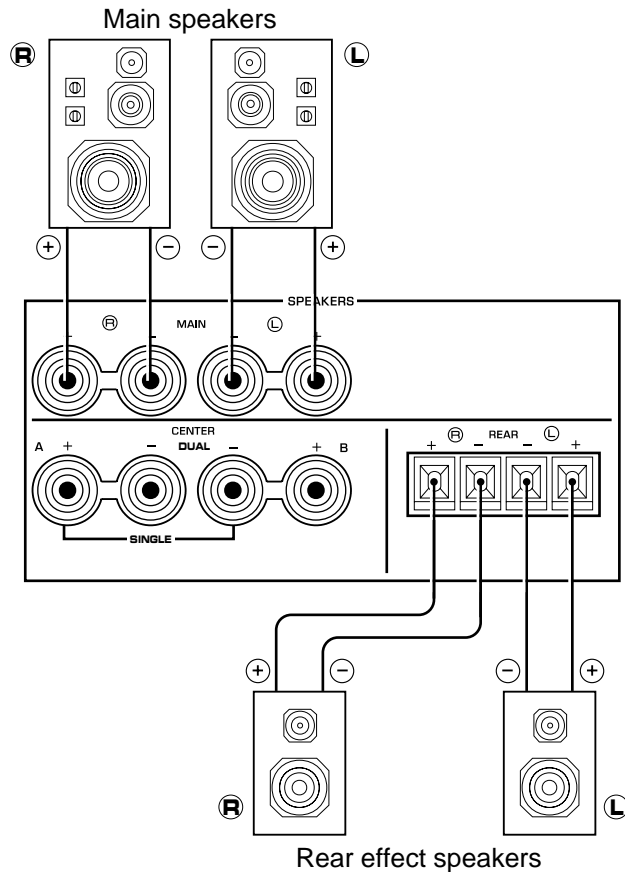

CONNECTING THE CENTER SPEAKER(S) TO THIS UNIT

Connect the CENTER speaker to the CENTER SPEAKERS terminals. One or two CENTER speakers can be connected to this unit. For the respective connections, follow the methods figured below. If, however, you will not be using a CENTER speaker, be sure to set the Center Mode to "PHNTM" (phantom). (See page 22.)

For connecting one CENTER speaker

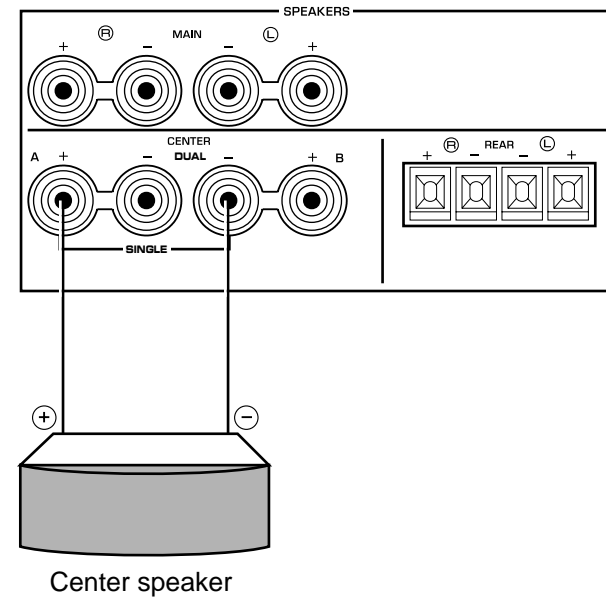

For connecting two CENTER speakers

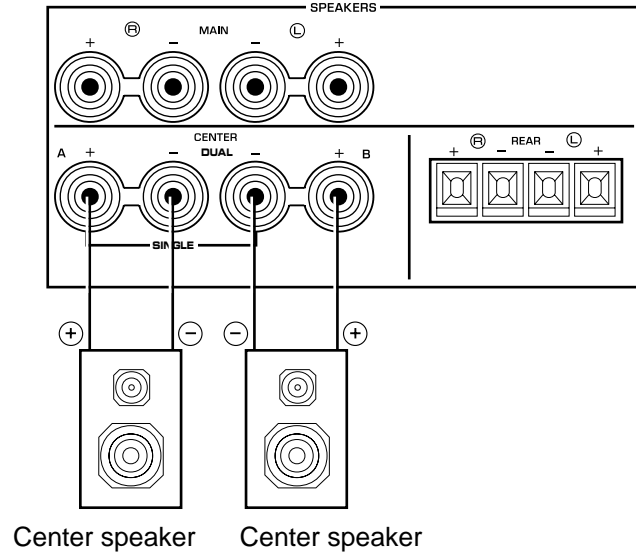

ADDING A SUBWOOFER

You may wish to add a subwoofer to reinforce the bass frequencies.

This unit provides a line-level subwoofer output, which contains only the frequencies under 200 Hz from the main and center channels. Connect the LOW PASS jack to the INPUT jack of the subwoofer amplifier, and connect the speaker terminals of the subwoofer amplifier to the subwoofer.

With some subwoofers, including the Yamaha Active Servo Processing Subwoofer System, the amplifier and subwoofer are in the same unit.

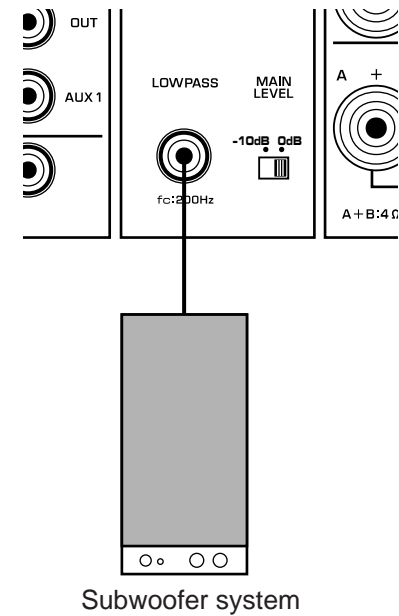

ADDITIONAL INFORMATION ON CONNECTING SPEAKERS (for Europe, U.K. and Australia models)

This unit is equipped with line output jacks for main, rear effect and center channels.

If you will use an external power amplifier for driving main speakers, connect input jacks of the external power amplifier to the MAIN OUTPUT jacks of this unit. (See Figure.)

For connecting an external power amplifier for driving rear effect speakers or center speaker to this unit, connect it to the corresponding line output jack(s) (REAR OUTPUT or CENTER OUTPUT) of this unit in the same way. (See Figure.)

NOTE: Even if an external power amplifier is connected to the MAIN, REAR or CENTER OUTPUT jacks, the corresponding internal amplifier will not be turned off and output will be available at the speaker terminals.

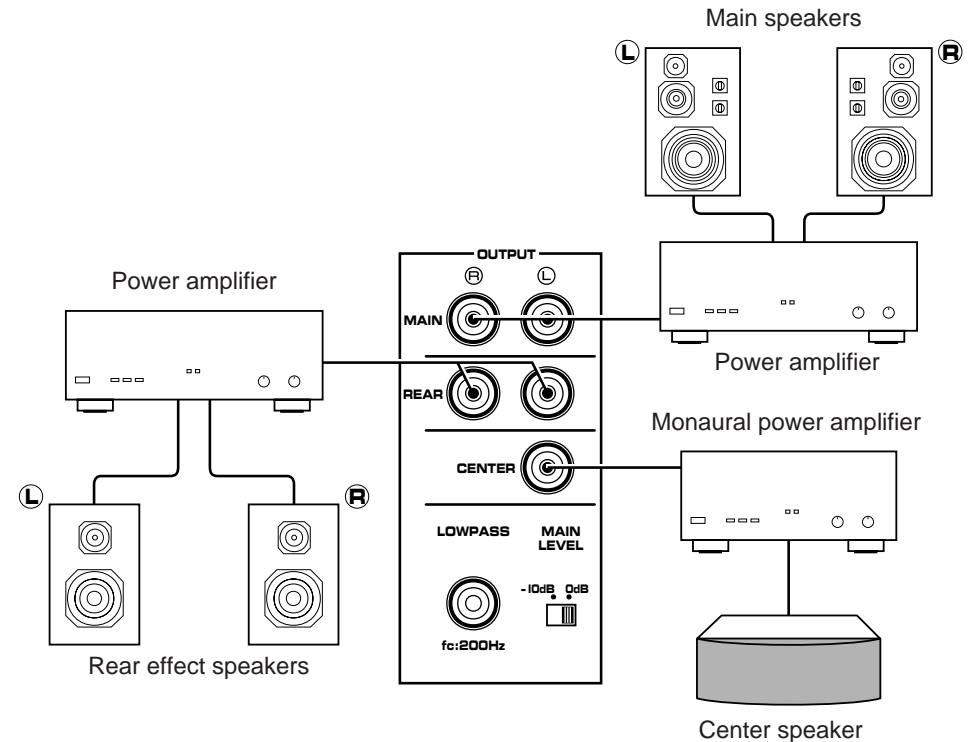

1-3. CONTROLS & ADJUSTMENTS

FRONT PANEL

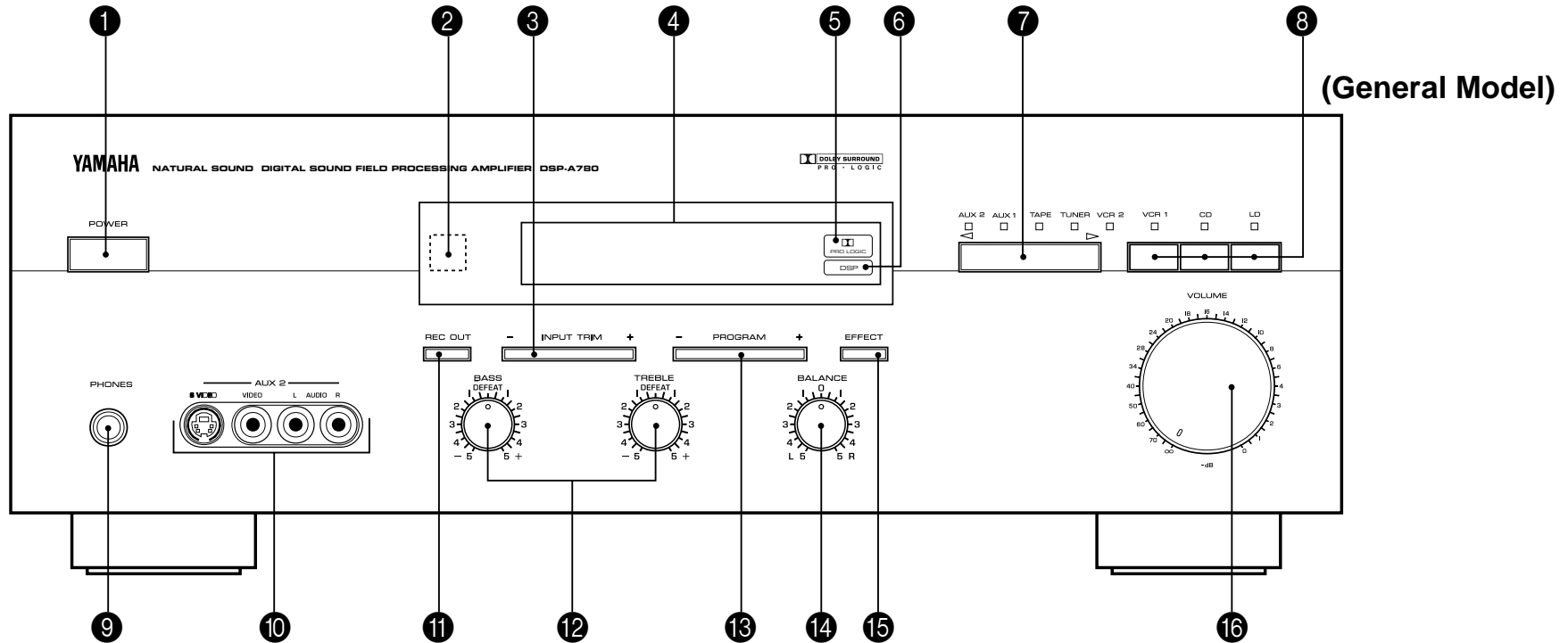

- 1** Power Switch
 * STANDBY Mode (Europe model only)
 While the power is on, pressing the POWER key on the remote control unit switches the unit to the STANDBY mode. (In this mode, the indicator is half illuminated.)
- 2** Remote control sensor
 Signals from the remote control unit are received here.
- 3** Input Trim Control
 Adjusts the input level of each source respectively.
- 4** Display Panel
 Shows program names, parameters and information about other various settings and adjustments.

- 5  PRO LOGIC Indicator
Illuminates while the built-in Dolby Pro Logic Surround Decoder is being activated.
- 6 DSP Indicator
Illuminates while the built-in Sound Field Processor is being activated.
- 7 Input Selector Switch
Sequentially selects the input source that you want to listen to and/or watch in the ◀ or ▶ direction. The indicator corresponding to the selected input source illuminates. The selected input source is also shown by the display panel and the monitor screen (When the monitor is on).
- 8 Input Selector Switches for VCR 1, CD and LD
Directly selects VCR 1, CD or LD as the input source.
- 9 Phones Jack
Plug in headphones here for private listening. If the Center Mode is set to “PHNTM” (phantom), the center channel will be heard along with the main channels. (See page 22.) Otherwise the main channels only will be heard.
- 10 Auxiliary Input Jacks (AUX 2)
Connect an auxiliary video or audio input source equipment such as a camcorder to these jacks. If the connected video equipment has a S video output terminal, connect it to the S VIDEO jack to obtain a high resolution picture. The source connected to these jacks can be selected by the input selector switch.
- 11 Rec Out Switch
Used to select the source to be recorded to tape deck or VCR independent of the selection of input source. When pressed, the indicator corresponding to the currently selected source to be recorded flashes. While an indicator is flashing, you can change the selection of the source to be recorded with the input selector switches. The selected source is also shown by the display panel and the monitor screen (when the monitor is on).
- 12 Bass and Treble Controls
Adjust the sound to match your tastes. Can also be used to compensate for room acoustics. Defeated in the center position.
- 13 Program Selector
Sequentially selects the digital sound field processing programs in the + or – direction.
- 14 Balance Control
Adjusts the left and right output volume to the Main Speakers to compensate for sound imbalance caused by speaker positions or listening room conditions.
- 15 Effect Switch
Normally ON, this switch can be turned OFF to disable output from the center and effect speakers so that the sound becomes normal 2-channel stereo.
- 16 Master Volume Control
Simultaneously controls signal level at all outputs: main, rear effect, center, and subwoofer. (This does not affect TAPE REC OUT level.)

REMOTE CONTROL UNIT

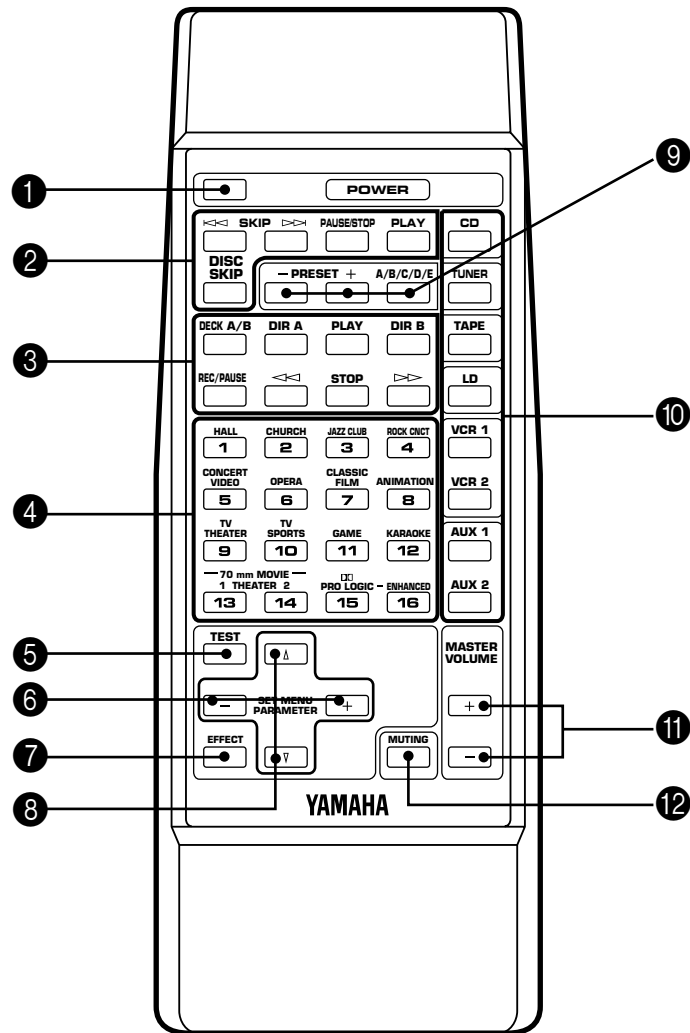

- 1** Power Key
Turns this unit on and off.
* (Europe model only): Turns the POWER on mode to the STANDBY mode and vice versa.
- 2** CD Function Keys
Operate functions on Yamaha CD players designed for remote control compatibility.
* DISC SKIP is applicable only to compact disc changer.
- 3** Tape Deck Function Keys
Operate functions on Yamaha tape decks designed for remote control compatibility.
* DIR A, B and DECK A/B are applicable only to double cassette tape deck.
* For a single cassette deck with automatic reverse function, pressing DIR A will reverse the direction of tape running.
- 4** Program Select Keys (1 through 16)
Select DSP programs 1 through 16.
- 5** Test Switch
When pressed, sends a signal to the main left, center, main right, and rear effect speakers in turn for easy comparison of level settings.
- 6** Set Menu/Parameter +/- Keys
Edit DSP program parameters, make settings/adjustments in the SET MENU mode, or used in the main/center/effect speaker level balance adjustment.
- 7** Effect On/Off Key
Cuts off the sound's output from the rear effect and center speakers. To restore the output from those speakers, press this key again.

- ⑧ **Set Menu/Parameter Select Keys**
Select DSP program parameters or titles of settings/adjustments in the SET MENU mode, or used in the main/center/effect speaker level balance adjustment.
- ⑨ **Tuner Function Keys**
Operate functions on Yamaha tuners designed for remote control compatibility.
 - * +: Selects higher preset station number.
 - : Selects lower preset station number.
 - A/B/C/D/E: Selects the page (A – E) of preset stations.
- ⑩ **Input Selector Keys**
Select the input sources to this unit.
- ⑪ **Master Volume +/- Keys**
Increase (+) or decrease (–) the master volume level.
- ⑫ **Muting Key**
Mutes the master volume level by 20 dB. While muting, the indicator on the master VOLUME control flashes on and off continuously.

1-4. ADJUSTMENT

MAIN/CENTER/REAR EFFECT SPEAKER LEVEL BALANCE ADJUSTMENT

This operation uses an internal test-tone generator for balancing the levels of the main, center and rear effect speakers. All speakers should be adjusted to the same apparent sound level for proper Dolby Pro Logic decoding.

1. Depress the TEST switch on the remote control to enter test mode. A hiss-like calibration signal should be heard from the left main speaker, center speaker(s), right main speaker and rear effect speakers in turn (see diagram). Adjust the MASTER VOLUME to a normal listening level.

* The state of test-tone output is shown by the display panel and the monitor screen. (Especially on the monitor screen, it is shown by an image of audio listening room.) This is convenient for adjusting each speaker level.

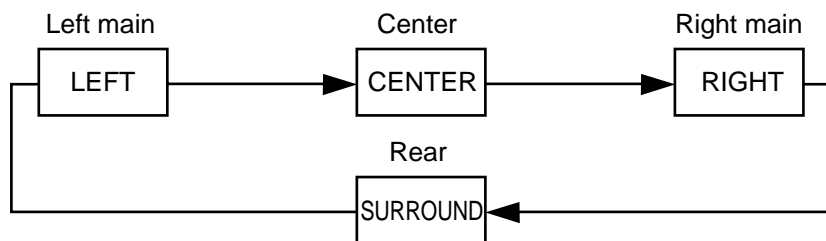

2. Adjust the center and rear effect speaker level.

For adjusting the center speaker level:

Press the SET MENU/PARAMETER select (Δ) key. "CENTER LEVEL ... dB" appears on the display and the test-tone is output from the center speaker(s). In this state, adjust the center speaker level by pressing the SET MENU/PARAMETER +/- keys.

For adjusting the rear effect speaker level:

Press the SET MENU/PARAMETER Select (∇) key. "SURROUND LEVEL ... dB" appears on the display and the test-tone is output from the rear effect speakers. In this state, adjust the rear effect speaker level by pressing the SET MENU/PARAMETER +/- keys.

Adjust each speaker level so that the sound coming from the corresponding speakers seems to be at the same level as that from the main speakers when you are at a normal listening position. If there is insufficient volume from the effect speakers, you may decrease the main speaker volume level by setting the MAIN LEVEL switch on the rear panel to "-10 dB", and adjust the center and rear level again.

NOTE: If the CENTER MODE is set to the PHNTM (phantom) position, the center speaker level cannot be adjusted. If using a center speaker, be sure to set the CENTER MODE to the "NRML" or "WD" position.

After completing this adjustment, press the TEST switch once again.

NOTE: Once you have completed these adjustments, use only this unit's MASTER VOLUME control to adjust listening volume. Do not change any other volume settings in the system.

INPUT LEVEL ADJUSTMENT

This adjustment is important for obtaining the best performance from the internal circuits of this unit. The optimum input level of this unit is pre-adjusted on the basis of the CD source level. This adjustment should be performed on all input sources in your system respectively, so that their levels match the CD source level as closely as possible.

1. Select the CD source.

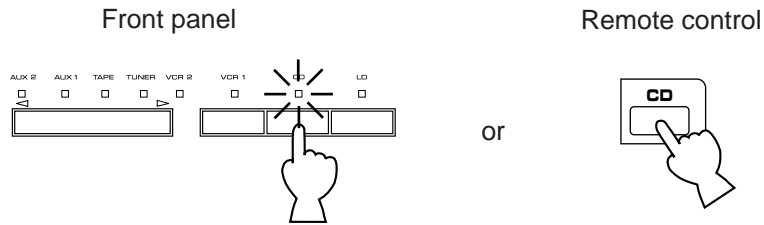

2. Play the source.
3. Increase the setting of the MASTER VOLUME control to a convenient listening level (you will use this as your "reference" level).

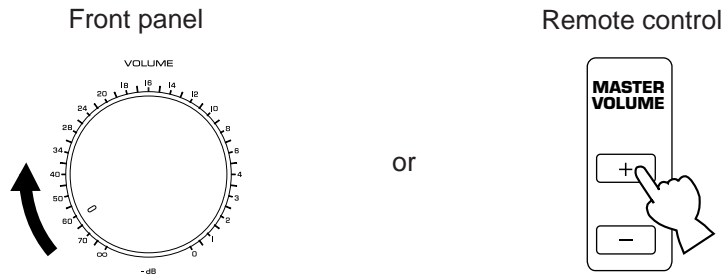

4. Select any other source in your system (VCR, tuner, etc.) and play that source.

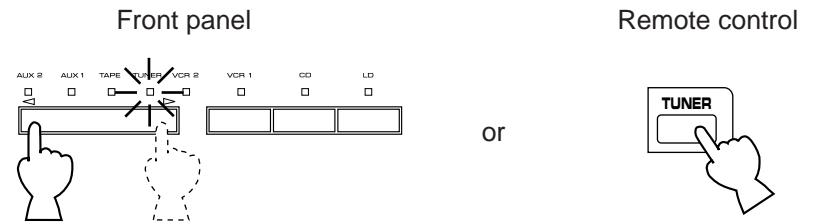

5. Adjust the level of the source to be approximately equal to your CD player's "reference" level by using the INPUT TRIM control.

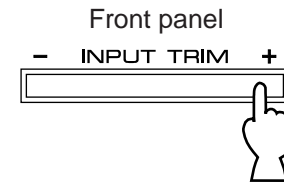

- * This adjustment can also be done with the remote control unit. For using the remote control unit, refer to "1. Input level adjustment (INPUT TRIM)" on page 22.

6. In the same way, adjust levels of other sources.

NOTE: The adjustments will be saved until it is readjusted.

OTHER IMPORTANT SETTINGS AND ADJUSTMENTS IN THE “SET MENU” MODE

The following four types of settings and adjustments should be done before enjoying audio and video sources. Note that these settings and adjustments cannot be done without monitoring the display information (or the information displayed on the monitor screen).

INPUT TRIM
CENTER MODE
DIMMER
MEMORY GUARD

SETTING/ADJUSTMENT PROCEDURE

1. Select an item (title) of setting/adjustment.

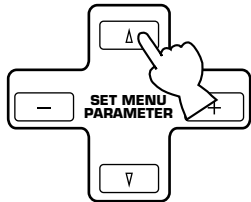

2. Select any desired mode or edit parameters on the item.

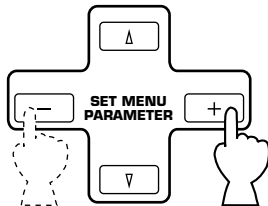

In the same way, perform settings/adjustments for other items.

DESCRIPTIONS OF THE ITEMS

1. Input level adjustment (INPUT TRIM)

This function is provided for all input sources. It can be controlled from 0 to +6 dB in 2 dB steps. The sound level of each input source should be the same as that of regular CDs.

For operations, after selecting the item “INPUT TRIM” (in step 1), select the input source on which the input level is to be adjusted by using the input selector switches, and then adjust the input level (in step 2).

* This adjustment can also be done with the INPUT TRIM control on the front panel. (see page 21.)

2. Selecting Center Mode (CENTER MODE NRML/WD/PHNTM)

In Normal (NRML) position, any frequency below 100 Hz will be divided between the main left and main right speakers. For this reason even a speaker smaller than the main left and right speakers can obtain a sufficient effect.

In Wide (WD) position, all range of frequencies for the center-channel are output to the center speaker. Select this position if a good quality center speaker is being used.

If not using the center speaker(s), be sure to select Phantom (PHNTM) position, and the audio signals for the center channel are output to the main speakers.

3. Changing brightness of the display (DIMMER)

You can select one of the five levels of brightness of the display.

4. Locking DSP parameters and other adjustments (MEMORY GUARD)

If you wish to prevent accidental alteration to DSP parameters or other adjustments on this unit, select "ON". In this position, they are locked and cannot be changed. The following functions on this unit can be locked by this operation.

- DSP parameters
- Other setting/adjustment items in the "SET MENU" mode (INPUT TRIM/CENTER MODE/DIMMER)
- INPUT TRIM control
- TEST switch

GENERAL OPERATION

2-1. PLAYING A SOURCE

1. Set the MASTER VOLUME control to minimum.

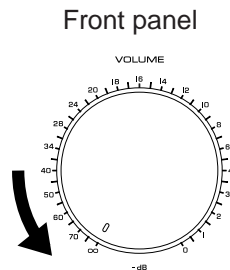

2. Turn the power on.

Front panel

POWER

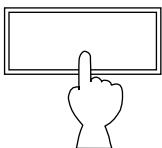

or

Remote control



3. Select an input source.

(The selected source is shown by the display panel, the monitor screen and illumination of the corresponding indicator over the input selector switches.)

Front panel

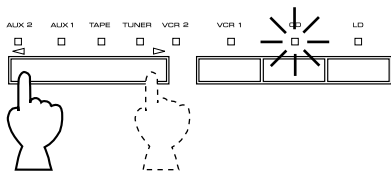

or

Remote control



- * On the front panel, VCR 1, CD or LD can be selected directly by pressing the corresponding switch.

Front panel

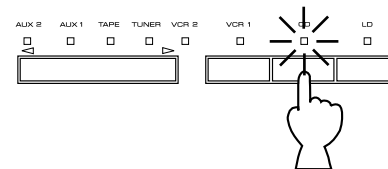

4. Play the source.

5. Increase the setting of the MASTER VOLUME control to your listening level.

Front panel

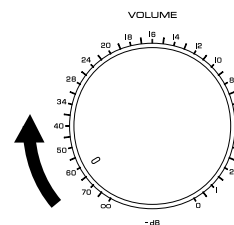

or

Remote control

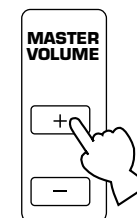

Adjust the BASS, TREBLE, BALANCE controls, etc., or select a desired sound field program. (See page 28.)

NOTE: If a different audio source is selected with the input selector keys on the remote control unit while enjoying a video source, the sound from the newly selected audio source is heard, but the picture from the video source can still be seen.

2-2. RECORDING A SOURCE TO AUDIO/VIDEO TAPE (OR DUBBING FROM A TAPE TO ANOTHER)

To record an input source to be played

1. Press the REC OUT switch (so that “REC OUT..” appears on the display and the monitor screen).

Front panel

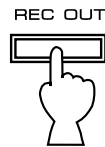

2. Within 5 seconds after the REC OUT switch is pressed, select the “SOURCE” position with the input selector switch (so that “REC OUT SOURCE” appears on the display panel and the monitor screen).

Front panel

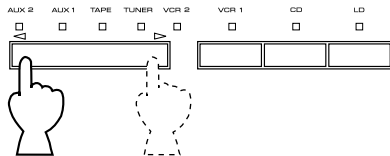

REC OUT SOURCE

3. Press the REC OUT switch (so that the indicator corresponding to the selected source to be recorded stops flashing).

* The same result will be gained after 5 seconds automatically without any operation.

4. Select an input source to be played (and to be recorded). (See page 24 for the method of input source selection.)

Front panel

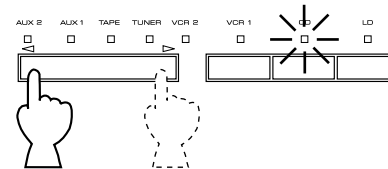

Remote Control

or



5. Play the source.

6. Set the tape deck or VCR used for recording to the recording mode.

* Adjust the recording level on the tape deck or VCR.

NOTE: To record picture from a video source and sound from another audio source, in step 4, first select a video source with an input selector key on the front panel, and then select an audio source with the input selector keys on the remote control unit.

To record a source other than the input source to be played

This unit has a function of selecting a source to be recorded to tape deck or VCRs independent of the selection of input source.

1. Press the REC OUT switch (so that “REC OUT...” appears on the display and the monitor screen).

Front panel

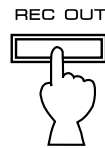

2. Within 5 seconds after the REC OUT switch is pressed, select the source to be recorded with an input selector switch.

Front panel

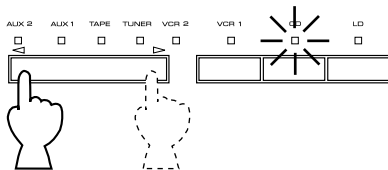

3. Press the REC OUT switch (so that the indicator corresponding to the selected source to be recorded stops flashing).
 - * The same result will be gained after 5 seconds automatically without any operation.
4. Play the source and confirm it by selecting it with an input selector switch and increasing the setting of the MASTER VOLUME control.

Front panel

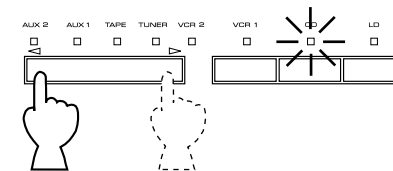

5. Set the tape deck or VCR used for recording to the recording mode.
 - * Adjust the recording level on the tape deck or VCR.
6. While recording a source, you can enjoy listening to and/or watching another source selected with an input selector switch.

Front panel

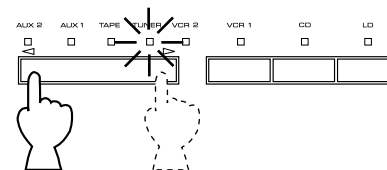

Remote control

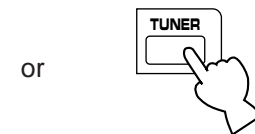

While recording, you can monitor the audio and/or video signals to be recorded by selecting the tape deck or VCR used for recording with an input selector switch.

NOTE: Adjusting the MASTER VOLUME, BASS, TREBLE controls, etc., or selecting a sound field program has no effect on the material being recorded.

NOTE: Composite video and S video signals pass independently through this unit's video circuits. Therefore, when recording or dubbing video signals between two video cassette recorders, if your source VCR is connected to provide only S video (or only composite video) signals, you can record only a S video (or only a composite video) signal on your second VCR.

NOTE: Please check the copyright laws in your country to record from records, compact discs, radio, etc. Recording of copyright material may infringe copyright laws.

If you watch a video software that uses scramble or encoded signals to prevent it from being dubbed, there may be a case that display information superimposed on the picture and/or the picture itself is disturbed according to the type of the signals.

2-3. DIGITAL SOUND FIELD PROGRAMS

This unit has 16 programs for digital sound field processing, 4 from actual acoustic environments from around the world, and 12 programs for Audio/Video sources including sources encoded with Dolby Pro Logic surround. Many of the programs contain various parameters that can be adjusted to the listener's taste.

2-4. SELECTING SOUND FIELD PROGRAMS

Select the desired sound field program by pressing the PROGRAM selector on the front panel or by using the Program Select keys on the remote control.

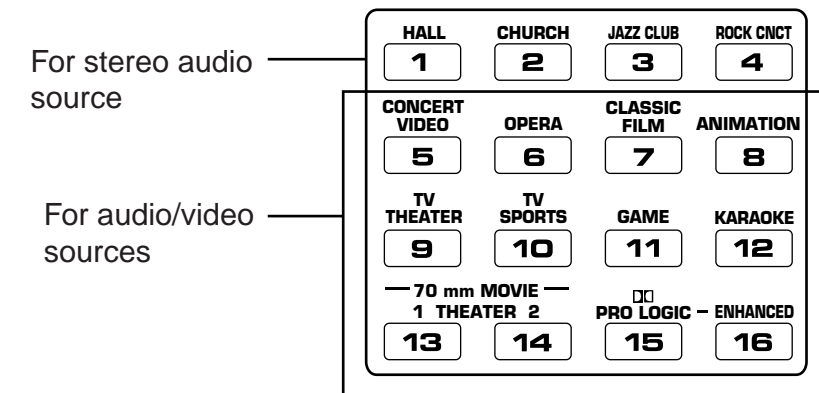

2-5. MUTING THE EFFECT SOUND

The EFFECT switch makes it simple to compare the normal stereo sound with the fully processed effect sound.

To mute the effect sound and monitor only the main sound, press the EFFECT switch. Press the EFFECT switch a second time to restore normal operation.

2-6. SUPERIMPOSED VIDEO PROGRAM/PARAMETER DISPLAY

You can select program names and edit parameters watching their data displayed on your video monitor screen and superimposed over the video image as described on page 5.

1. Turn your monitor on.
2. Program name and its parameters will be displayed on the monitor screen for a few seconds just after you have selected them. Parameters are selected by pressing the SET MENU/PARAMETER Select (▽) key, and edited by pressing the SET MENU/PARAMETER +/- keys. (See page 34 for details.)

2-7. DESCRIPTIONS OF THE SOUND FIELD PROGRAMS

The following list gives brief descriptions of the sound fields produced by each of the DSP programs. Keep in mind that most of these are precise digital recreations of actual acoustic environments. The data for them was recorded at the locations described using sophisticated sound field measurement equipment.

*** The channel level balance between the left rear effect speaker and the right rear effect speaker may vary depending on the sound field you are listening to. This is due to the fact that most of these sound field recreations are actual acoustic environments.**

1. CONCERT HALL:

A large round concert hall with a rich surround effect. Pronounced reflections from all directions emphasize the extension of sounds. You will experience the sound field with a great deal of presence sitting at about the center position near the stage.

This sound field is also effective for karaoke. This is because you feel as if you are standing on a real stage.

3. JAZZ CLUB:

A jazz club in New York. It is in a basement and has a relatively spacious floor area. The reflection pattern is similar to that of a small hall.

2. CHURCH:

A church in Tokyo shaped like a cross. There is the altar at the upper side of the “cross”, and a pipe organ at the opposite side (the lower side of the cross). It is a very unique shape with walls all leaning inside, and pillars standing by the side of walls only. The sound field has moderate reverberations of which time is 2.5 seconds.

4. ROCK CONCERT:

The ideal program for lively, dynamic rock music. The data for this program was recorded at LA’s “hottest” rock club.

5. CONCERT VIDEO:

This program produces an enthusiastic atmosphere and lets you feel that you are in the midst of the action, as if attending an actual jazz or rock concert.

The indirect sound constituent spreads on the surround side of the sound field by the use of data of a large round hall for the surround side, so the image space around the screen and the sound space are fully expanded.

7. CLASSIC FILM:

This program is for reproducing monaural video sources (old movies etc.). Monaural sounds are reproduced with much presence by the front presence side of the sound field and optimum reverberation effect. The use of the center speaker makes conversations more audible, obtaining a pleasant mix of conversations and picture.

6. OPERA:

This program provides excellent depth of vocals and overall clarity, restraining excessive reverberation.

For opera, the orchestra pit and the stage are ideally combined, letting you feel a full presence sound. The rear surround side of the sound field is relatively moderated, however, it reproduces beautiful sound by the use of the data of a concert hall. You will not be tired from long watching of an opera.

8. ANIMATION:

Powerful reverberations on the front presence side of the sound field adds depth to the image, so expanding the image space. On the rear surround side, sounds are reproduced lightly but vividly. The sound field of this program matches image effects of animated films regardless of the genre. Conversations, sounds and sound effects are reproduced with vitality by this program. A source in stereo will obtain more effect, letting you steep yourself in a fantastic world of animations.

9. TV THEATER:

The data of the sound field of a relatively narrow space is used for the front presence side. A moderately sized spatial sound field without excessive sound extension and reverberations gives reality to the characters in a drama.

The data of the sound field of an opera house is used for the rear surround side. In a stereo program, background music is reproduced more beautifully with much depth, enhancing sound effects on the drama. It's natural sound effect will not make you tired from long watching.

11. GAME:

The sound field of a disco is used for the front presence side, and the sound field of a concert hall in Vienna is used for the rear surround side.

This program reproduces video game music etc. more vividly emphasizing the fast tempo and lightness of the music. If the music is in stereo, more effective sound field will be gained by this program.

This program is also suitable for karaoke popular music.

10. TV SPORTS:

Though the front presence side of the sound field is relatively narrow, the rear surround side employs the sound environment of a large concert hall. With this program, you can enjoy watching various TV programs such as the news, variety shows, music programs or sports programs. In a stereo broadcast of a sports game, the commentator is oriented at the center position, and the shouts and the atmosphere in the stadium spreads on the surround side, however, spreading of them to the rear side is properly restrained.

12. KARAOKE:

Vocals are reproduced with gentle reverberations on the stage surrounded by seats in a round hall. A feeling of echo from the high ceiling and reverberations in front and behind the hall brings a lot of presence on both the stage and the seats. By using a source with digital sound, the sound of the greatly instrumental accompaniment is much expanded, so emphasizing the spatial effect with vocals. You feel as if you are standing on a live-stage.

Programs No. 13 through No. 16 reproduces video discs, video tapes and similar sources which are Dolby Surround encoded and bear the "DOLBY SURROUND" logo.

13. 70 mm MOVIE THEATER 1:

This program is ideal for precisely reproducing the sound design of the newest movies. The sound field is made according to the design of the newest movie theaters, so the reverberations of the sound field itself are restrained as much as possible. The three dimensional feeling of the sound field is emphasized, and dialog is precisely oriented on the screen. You can enjoy watching S.F.X., adventure movies, etc. with this program.

15. PRO LOGIC:

The digital Dolby Pro Logic decoder reproduces sounds and sound effects of a source encoded in Dolby Surround. The realization of a highly efficient decoding process improves crosstalk and channel separation and makes sound positioning smoother and more precise.

14. 70 mm MOVIE THEATER 2:

This program is for reproducing sounds on a 70 mm multi-track film, and characterized by a soft and extensive sound field. The front presence side of the sound field is relatively narrow. It spatially spreads all around and toward the screen, restraining echo effect of conversations without losing clarity. For the surround side, the data of the sound field of an opera house is used on an enlarged scale, so the harmony of music or chorus sounds beautifully in a wide space at the rear of the sound field.

16. PRO LOGIC ENHANCED:

This program ideally simulates the multi-surround speaker systems of the 35 mm film theater. Surround signals by the Dolby Pro Logic decoder are processed on the surround side of the sound field based on the data of the sound field of a shoe-box hall. The surround effects produced by this sound field folds the viewer naturally from the rear to the left and right and toward the screen.

NOTE: The Dolby Pro Logic Surround system is designed to be used with program material (mainly videotaped movie soundtracks) encoded with the Dolby Surround system.

NOTE: If the main and center channel sound is considerably altered by overadjustment of the BASS or TREBLE controls, the relationship with the rear channels may produce an unnatural effect.

CREATING YOUR OWN SOUND FIELDS

3-1. SELECTING AND EDITING PROGRAM PARAMETERS

WHAT IS A SOUND FIELD?

In order to explain the impressive functions of the DSP system, we need to first understand what a sound field really is.

What really creates the rich, full tones of a live instrument are the multiple reflections from the walls of the room. In addition to making the sound “live”, these reflections enable us to tell where the player is situated, and the size and shape of the room in which we are sitting. We can even tell whether it is highly reflective, with steel and glass surfaces, or more absorbent—wood panels, carpeting and curtains.

THE ELEMENTS OF A SOUND FIELD

In any environment, in addition to the direct sound coming straight to our ears from the player’s instrument, there are two distinct types of sound reflections that combine to make up the sound field:

(1) Early Reflections. Reflected sounds reach our ears extremely rapidly (50 ms — 100 ms after the direct sound), after reflecting from one surface only—for example, from the ceiling or a wall. These reflections fall into specific patterns as shown in the diagram on page 35 for any particular environment, and provide vital information to our ears. Early reflections actually add clarity to the direct sound.

(2) Reverberations. These are caused by reflections from more than one surface—walls, ceiling, the back of the room—so numerous that they merge together to form a continuous sonic “afterglow”. They are non-directional, and lessen the clarity of the direct sound.

Direct sound, early reflections and subsequent reverberation taken together help us to determine the subjective size and shape of the room, and it is this information that the DSP system reproduces in order to create sound fields.

If you could create the appropriate early reflections and subsequent reverberations in your listening room, you would be able to create your own listening environment. The acoustics in your room could be changed to those of a concert hall, a dance floor, or virtually any size room at all. This ability to create sound fields at will is exactly what Yamaha has done with the DSP system.

DSP programs consist of some parameters to determine apparent room size, reverberation time, distance from you to the performer, etc. In each program, those parameters are preset with values precisely calculated by Yamaha to create the sound field unique for the program. It is recommended to use DSP programs without changing values of parameters, however, this unit also allows you to create your own sound fields. Starting with one of the built-in programs, you can adjust those parameters. Even if power is turned off, your custom sound fields will remain in the DSP system’s memory for about two weeks. The following pages detail how to make your own sound fields.

Each sound field program has a set of parameters that allow you to change the characteristics of the acoustic environment to create precisely the effect you want. These parameters correspond to the many natural acoustic factors that create the sound field you experience in an actual concert hall or other listening environment. The size of the room, for example, affects the length of time between the “early reflections”—that is, the first few widely spaced reflections you hear after the direct sound. The “ROOM SIZE” parameter provided in many of the DSP programs alters the timing between these reflections, thus changing the shape of the “room” you hear. In addition to room size, the shape of the room and the characteristics of its surfaces have a significant effect on the final sound. Surfaces that absorb sound, for example, cause the reflections and reverberations to die out quicker, while highly reflective surfaces allow the reflections to carry on for a longer period of time. The DSP parameters allow you to control these and many other factors that contribute to your personal sound field, allowing you to essentially “redesign” the concert halls and rooms provided to create custom-tailored listening environments that ideally match your mood and music.

Refer to “3-2. DESCRIPTIONS OF THE DIGITAL SOUND FIELD PARAMETERS” on page 35 for a description of what each parameter does, how it effects the sound, and its control range.

1. With the desired program selected, press the SET MENU/ PARAMETER Select (▽) key on the remote control unit once. This will recall the first parameter. In the case of the CONCERT HALL program, for example, this would be the INIT. DLY parameter. You can continue pressing the SET MENU/ PARAMETER Select (▽) key to select other parameters in sequence. If the key is pressed when the last parameter is being displayed, the first parameter is selected again.

2. When the desired parameter has been recalled, use the SET MENU/ PARAMETER + (increment) and – (decrement) keys to change its value to create the effect you want. + increases the value of the selected parameter, and – decreases the value of the selected parameter. In both cases you can hold the key down for continuous incrementing or decrementing. The display will pause for a moment at the initial value of the parameter as a reminder. (On the monitor screen, * mark at the head of parameter name disappears at the initial value of the parameter.)

NOTE: Parameter edits made in this way will remain in effect even with power cut due to power failure or the power plug disconnected from the AC outlet for up to about two weeks, after which all parameters, as well as other adjustments or settings on this unit, will return to their initial values or conditions.

3-2. DESCRIPTIONS OF THE DIGITAL SOUND FIELD PARAMETERS

Not all of the following parameters are found in every program.

- **INIT DLY (Initial Delay)**

How it Affects the Sound:

Changes the apparent distance from the source sound.

Since the distance between a sound source and a reflective surface determines the delay between the direct sound and the first reflection, this parameter changes the location of the sound source within the acoustic environment.

What it Does:

Adjusts the delay between the direct sound and the first reflection heard by the listener.

Control Range:

1 – 49 milliseconds

For a small living room this parameter would be set for a small value. Large values for a big room. Larger values produce an echo effect.

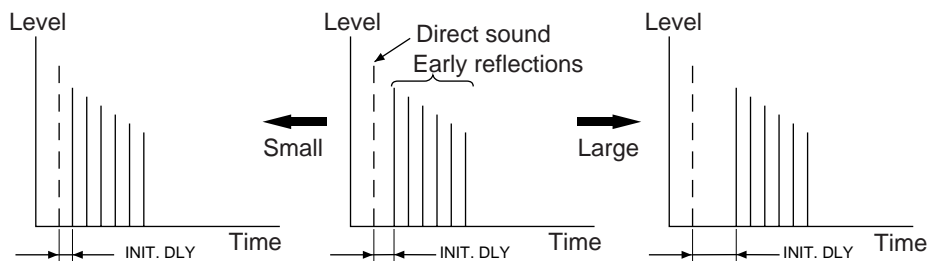

- **ROOM SIZE**

How it Affects the Sound:

Changes the apparent size of the music venue. The larger the value, the larger the simulated room will sound.

What it Does:

Adjusts the timing between the early reflections. Early reflections are the first group of reflections you hear before the subsequent, dense reverberation begins.

Control Range:

0.1 – 2.0

Standard setting is 1.0.

Changing this parameter from 1 to 2 increases the apparent volume of the room eight times (length, width, and height all doubled).

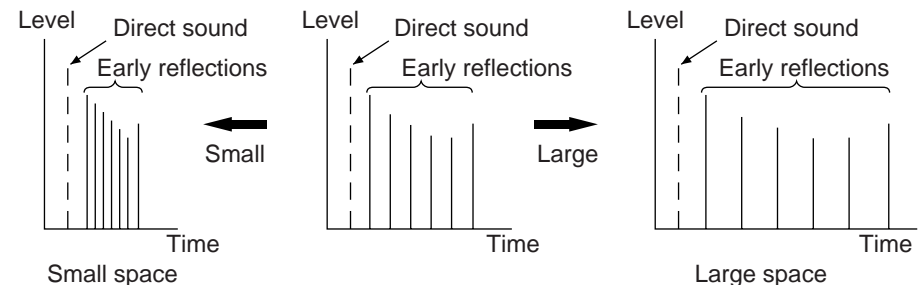

- **REV. TIME (Reverberation Time)**

How it Affects the Sound:

The natural reverberation time of a room depends primarily on its size and the characteristics of its inner surfaces. This parameter, therefore, changes the apparent size of the acoustic environment over an extremely wide range.

What it Does:

Adjusts the amount of time it takes for the level of the dense, subsequent reverberation sound to decay by 60 dB (@ 1 kHz).

Control Range:

1.0 – 5.0 seconds.

The reverb time in a small-to-medium size hall would be between 1 and 2, and in a large hall it is normally between 2 and 3.

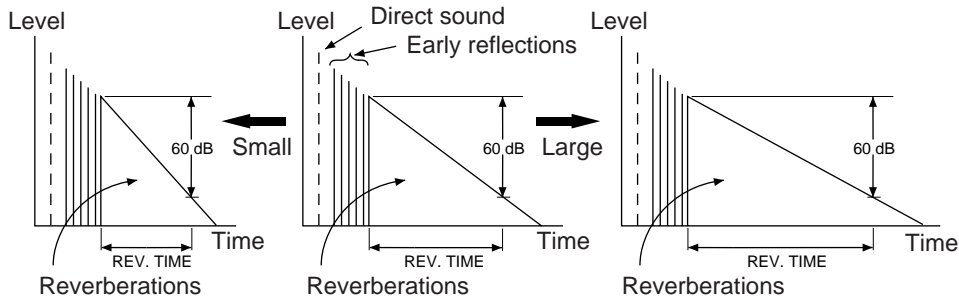

- **EFCT TRIM (Effect Trim)**

Performs fine adjustment of the level of all the effect sounds.

Control Range:

–3 dB to 3 dB

- **DELAY**

Adjusts the delay between the direct sounds (at the main left, center and main right channels) and the effect sounds (at the front effect and rear effect channels). The larger the value, the later the effect sounds are generated.

Control Range:

15 – 30 milliseconds

TROUBLESHOOTING

PROBLEM	POSSIBLE CAUSE	WHAT TO DO
Power does not come on.	AC cord not properly plugged in.	Carefully plug AC plug into outlet.
Hum.	Bad cable connection.	Firmly plug in all connection cables.
No sound.	Bad or incorrect input connection. Incorrect input source selection.	Check connections. Select the appropriate input source with the input selector switch.
No sound from the effect speakers.	The EFFECT switch is set off. The DOLBY PRO LOGIC program is being used with material not encoded with Dolby Surround.	Press the EFFECT switch to turn on. Use a different sound field program.
No sound from the center speaker.	The center mode is in "PHNTM". Incorrect sound field program.	Select the appropriate center mode. Select the appropriate program.
The sound suddenly goes off.	The protection circuit has activated because of short circuit etc.	Turning the unit off and then on will reset the protection circuit.
The volume level cannot be increased, or sound is distorted.	The power to the component connected to the REC OUT jacks of this unit is off.	Turn the power to the component on.
DSP parameters or other settings on this unit cannot be changed.	The "MEMORY GUARD" function is set ON.	Turn the "MEMORY GUARD" OFF.
Left rear and right rear channels not balanced in certain digital sound field programs.	This is normal operation and is an exact duplication of the actual data which was measured for that particular hall etc.	
The sound field cannot be recorded.	It is not possible to record the sound field on a tape deck connected to this unit's TAPE REC OUT jacks.	
The remote control unit does not function properly.	Dead batteries. Wrong distance or angle. Direct sunlight or lighting (of an inverter type of fluorescent lamp etc.) is striking the remote control sensor of the main unit.	Replace batteries. The remote control unit will function from a maximum range of 7 meters, no more than 30 degrees off-axis from the front panel. Change position of the main unit.
Noise from nearby TV or tuner.	This unit is too close to the affected equipment.	Move the unit further away from the affected equipment.

SPECIFICATIONS

Minimum RMS Output Power Per Channel

Main (20 Hz – 20 kHz 0.015% THD 8Ω)	
[U.S.A. and Canada models]	65W+65W
[Australia, Europe, U.K. and General models]	60W+60W
Center (20 Hz – 20 kHz 0.015% THD 8Ω)	
[U.S.A. and Canada models]	65W
[Australia, Europe, U.K. and General models]	60W
Rear Effect (1 kHz 0.03% THD 8Ω)	25W+25W

Maximum Output Power [General model]

Main (1 kHz 10% THD 8Ω)	95W+95W
Center (1 kHz 10% THD 8Ω)	95W

Dynamic Power Per Channel

(by IHF Dynamic Headroom Measuring Method)

[U.S.A. and Canada models]	
(8Ω/6Ω/4Ω)	75W/90W/105W

DIN Standard Output Power Per Channel [Europe model]

(1 kHz 0.7% THD 4Ω)	100W
---------------------	------

Dynamic Headroom [U.S.A. and Canada models]

(8Ω)	1.2 dB
------	--------

IEC Power [Europe model]

(1 kHz 0.015% THD 8Ω)	70W
-----------------------	-----

Damping Factor

(1 kHz 8Ω)	More than 75
------------	--------------

Input Sensitivity/Impedance (100W/8Ω)

CD/TUNER/TAPE/LD/VCR/AUX	150 mV/47 kΩ
--------------------------	--------------

Maximum Input Signal

CD/TUNER/TAPE/LD/VCR/AUX	
(1 kHz 0.5% THD, EFFECT ON)	More than 2.3V

Output Level/Impedance

REC OUT	150 mV/1 kΩ
LOW PASS (fc=200 Hz) (EFFECT OFF)	4.0V/1.8 kΩ

Headphone Jack Rated Output/Impedance

Output Level (8Ω, 1kHz, 0.03% THD)	0.2V
Impedance	100Ω

Frequency Response (20 Hz – 20 kHz)

CD/TUNER/TAPE/LD/VCR/AUX to MAIN L/R SP OUT	0±0.5 dB
---	----------

Total Harmonic Distortion

CD/TUNER/TAPE/LD/VCR/AUX to SP OUT	
30W/8Ω, MAIN L/R, 20 Hz – 20 kHz	Less than 0.02%
10W/8Ω, REAR L/R, 1 kHz	Less than 0.3%
Built-in amplifier	
30W/8Ω, MAIN L/R, CENTER, 20 Hz – 20 kHz	Less than 0.008%
10W/8Ω, REAR L/R, 20 Hz – 20 kHz	Less than 0.03%

Signal-to-Noise Ratio (IHF-A Network)

CD/TUNER/TAPE/LD/VCR/AUX (Input Shorted) (EFFECT OFF)	
	More than 96 dB

Residual Noise (IHF-A Network)

MAIN L/R SP OUT	Less than 150 μV
-----------------	------------------

Channel Separation Vol –30 dB

CD/TUNER/TAPE/LD/VCR/AUX Input 5.1 kΩ Terminated (EFFECT OFF)	
1 kHz/10 kHz	More than 60 dB/45 dB

Tone Control Characteristics (MAIN L/R)

Bass	
Boost/Cut	±10 dB (50 Hz)
Turnover frequency	350 Hz
Treble	
Boost/Cut	±10 dB (20 kHz)
Turnover frequency	3.5 kHz

Filter Characteristics (Highcut Filter)

LOW PASS (fc = 200 Hz)	6 dB/oct.
------------------------	-----------

Audio muting	-20 dB
--------------	--------

Video Section

Video Signal Type	
[U.S.A. and Canada models]	NTSC
[Australia, Europe and U.K. models]	PAL
[General Model]	NTSC/PAL
Video Signal Level	1 Vp-p/75Ω
S-Video Signal Level	
Y	1 Vp-p/75Ω
C	0.286 Vp-p/75Ω
Maximum Input Level	More than 1.5 Vp-p
Signal-to-Noise Ratio	More than 50 dB
Monitor Out Frequency Response	5 Hz – 10 MHz, –3 dB

Power Supply

U.S.A. and Canada models	AC 120V/60 Hz
Australia and U.K. models	AC 240V/50 Hz
Europe model	AC 230V/50 Hz
General model	AC 110/120/220/240V 60/50 Hz

Power Consumption

U.S.A., Australia, Europe, U.K. and General models	230W
Canada model	230W, 320 VA

AC Outlets

2 SWITCHED OUTLETS	
[U.S.A. and Canada models]	120W max. total
[General model]	100W max. total
1 SWITCHED OUTLET	
[Australia, Europe and U.K. models]	100W max.
1 UNSWITCHED OUTLET	
[U.S.A. and Canada models]	180W max.
[General model]	200W max.

Dimensions (W x H x D)	435 x 146 x 410 mm (17-1/8" x 5-3/4" x 16-1/8")
-------------------------------	--

Weight	11.0 kg (24 lbs. 3 oz.)
---------------	-------------------------

* Specifications are subject to change without notice.

YAMAHA CORPORATION

YAMAHA ELECTRONICS CORPORATION, USA 6660 ORANGETHORPE AVE., BUENA PARK, CALIF. 90620, U.S.A.
YAMAHA CANADA MUSIC LTD. 135 MILNER AVE., SCARBOROUGH, ONTARIO M1S 3R1, CANADA
YAMAHA ELECTRONIK EUROPA G.m.b.H. SIEMENSSTR. 22-34, D-25462 RELINGEN BEI HAMBURG, F.R. OF GERMANY
YAMAHA ELECTRONIQUE FRANCE S.A. RUE AMBROISE CROIZAT BP70 CROISSY-BEAUBOURG 77312 MARNE-LA-VALLÉE CEDEX02, FRANCE
YAMAHA ELECTRONICS (UK) LTD. YAMAHA HOUSE, 200 RICKMANSWORTH ROAD WATFORD, HERTS WD1 7JS, ENGLAND
YAMAHA SCANDINAVIA A.B. J A WETTERGRENS GATA 1, BOX 30053, 400 43 VÄSTRA FRÖLUNDA, SWEDEN
YAMAHA MUSIC AUSTRALIA PTY, LTD. 17-33 MARKET ST., SOUTH MELBOURNE, 3205 VIC., AUSTRALIA