



Electronic Calculator Operating Manual
Calculatrice Electronique Manuel du Fonctionnement
Calculadora Electronica Manual de Instrucciones



**Model
Modèles
Modelos**

**1530-6
1560-6
1570-6**

Preface

Congratulations on your choice of a Victor electronic calculator. Careful design, quality materials, painstaking workmanship, and advanced research and production facilities have given you a calculator that, with proper care, will provide years of trouble-free service. To assure future optimum performance, ask your Victor representative about low-cost protection offered by Victor's Extended Guarantee Protection Program. (To order see enclosed form on Page 68)

This operating manual describes the features and operation of the Victor 1530-6, 1560-6 and 1570-6 electronic calculators. Where applicable, differences among the three calculators are clearly noted in the manual. Each model is a commercial-grade calculator with 10, 12 or 14-digit capacity and two-color ribbon printing.

Model 1530-6 is a print/display calculator, 10-digit,
with one independent memory

Model 1560-6 is a print/display calculator, 12-digit,
with one independent memory

Model 1570-6 is a print/display calculator, 14-digits,
with two independent memories

Each calculator also features the four basic arithmetic operations, financial, amortization, present value/future value, days between days, time calculations, grand total, percentage and percentage-of-change, cost, sell, margin, change sign, sigma, item count with averaging, non-add/date functions, programmable tax rate key, backspace, units/price mode calculations, square root function, time and date functions with battery back-up.

TABLE OF CONTENTS

Operations and General Maintenance	3
Replacing the Ribbon/Cartridge	4
Paper Feed	5
Battery Replacement	5
Keyboard Diagrams	6
Keyboard Layout	7
Slide Switch Features	8
Key Features	10
Troubleshooting	14
Application Examples	39
Setting the Date and Time	65,66
Warranty	67
Extended Warranty	68

BEFORE TURNING ON - Please remove the shipping-cushion placed on the ribbon and check the rating label on the bottom to see if the rated voltage corresponds to the local voltage before plugging in the AC cord.

Note: Ribbon cushion is located under printer cover.

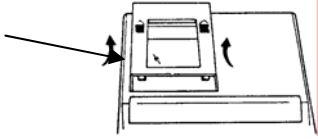

ACTIVATE BACKUP BATTERY

Before start using the calculator, please remove the insulation paper below the backup battery.

1. Turn the AC power switch OFF and remove the battery compartment cover located on the bottom case.
2. Remove the insulation paper located below the backup battery.
3. PRESS THE RESET SWITCH.
4. Replace the battery compartment cover.
5. Turn ON the AC power switch.
6. Program the date and time according to the instruction manual.

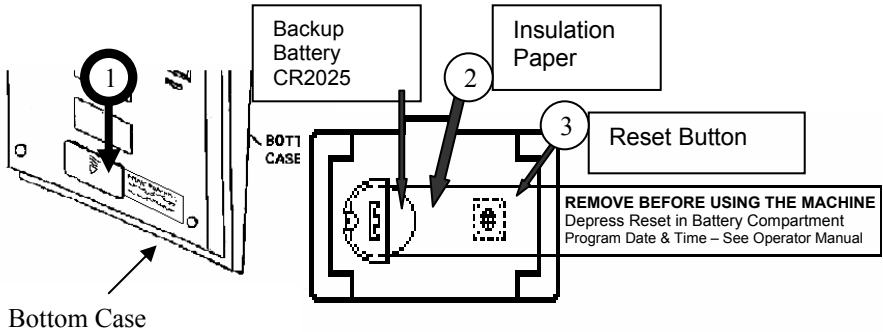

GENERAL MAINTENANCE

1. Do not place the machine in hot, dusty or damp locations.
2. To clean the housing use a silicon-treated cloth. Do not use water or detergents.
3. Do not place anything on the housing, particularly on the head of the printer mechanism:
4. Turn off the power switch before removing the plug from AC wall outlet.
5. Turn the power switch off while not in use.

REPLACING THE RIBBON

Your calculator is shipped with a 2-color ribbon already in place. You do not need to install or change it before you begin using the calculator. When you have been using your calculator for some time, however, the print will gradually become faint, indicating that you should change the ribbon. To change the ribbon, follow these steps.

1. Remove paper roll, tearing paper at rear of calculator. Use the Paper Advance (↑) key to feed the remaining paper tape through the printer. Then remove the printer cover.
2. Remove the old ribbon by pulling upward.
3. Install the ribbon spool with the black edge up. Roll from the outside of the full spool and place the first spool on the spindle not engaged by the lever. Thread the new ribbon along the outside of the guides and in front of the print wheels. Switch the lever to the other side and replace the second spool.
4. Rotate the spools to take up any slack. Replace the printer cover and the paper tape. **(Replace with Victor Ribbon #7010)**

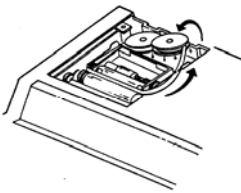

Correct Direction

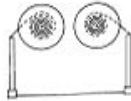

Incorrect Direction

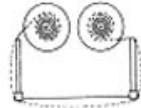

REPLACING WITH CARTRIDGE RIBBON

You have the option to use a cartridge ribbon in this model.

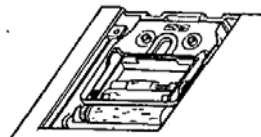

1. Remove paper roll, tearing paper at rear of calculator. Use the Paper Advance (↑) key to feed the remaining paper tape through the printer. Then remove the printer cover.
2. Remove the old ribbon/cartridge by pulling upward
3. Install the new cartridge by pressing it down with the VICTOR logo facing up, as shown.
4. Replace the printer cover and the paper tape. **(Replace with VICTOR cartridge #7011)**

HOW TO FEED THE PAPER TAPE

1. Put the new paper roll on the paper arm.
2. Insert the paper into the slot as indicated.
3. Depress the paper feed key.
4. Suitable paper roll:

Width: max. 58mm (2.25")
Diameter: max. 50mm (1.97")
Paper: Normal paper
(45kg/1000 sheets/788 x 1091 mm)

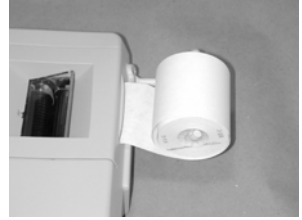

BATTERY REPLACEMENT

1. Turn the AC power switch off
2. Remove - the battery compartment cover located on the calculator bottom case.
3. Remove the old battery and install a new CR2025 or equivalent.
4. Turn on the AC power switch
5. **PRESS THE RESET BUTTON**
6. Replace the battery compartment cover.
7. Reprogram the date and time.
(See page 64 & 65)

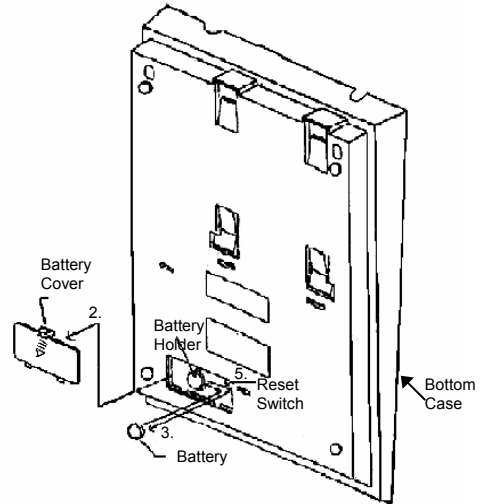

CAUTION

Danger of explosion if battery is incorrectly replaced. Only replace with the same or equivalent type recommended by the manufacturer. Dispose of used batteries according to the manufacturers' instructions.

Model 1570-6 Keyboard Layout

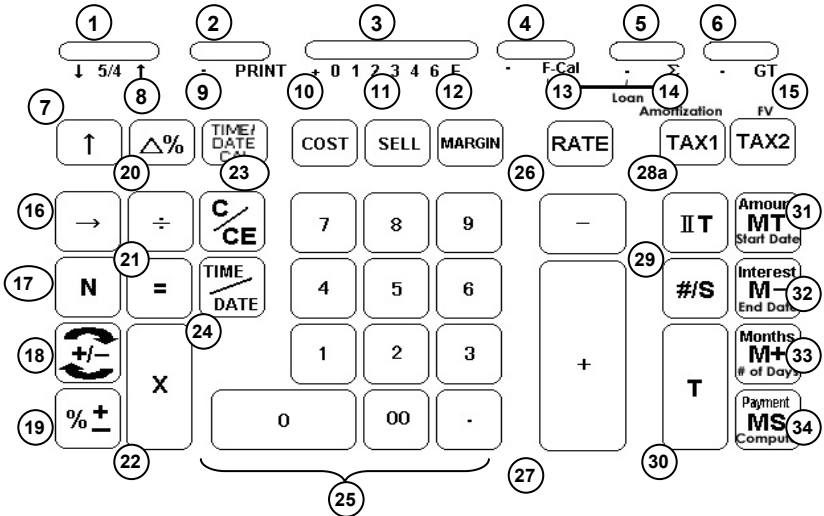

Model 1560-6 and 1530-6 Keyboard Layout

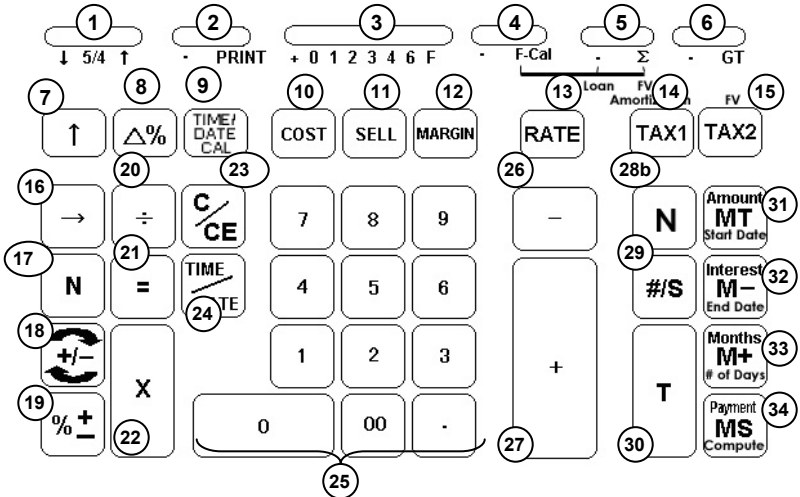

KEYBOARD LAYOUT

1. Rounding Selector	19. Percentage
2. Print Switch	20. Division
3. Decimal Selector	21. Equal
4. Financial Calculation Switch	22. Multiplication
5. Sigma/Loan and FV Switch	23a. Clear / Clear Entry
6. Grand Total Switch	24. Time / Date Display
7. Paper Feed	25. Numeric Key Pad
8. Delta Percentage	26. Subtraction
9. Time/Date Calculation	27. Addition
10. Cost	28a. Memory II Selector
11. Sell	28b. Item Count
12. Margin	29. Subtotal / Date
13. Tax Rate Preset	30. Total
14. Tax 1/Amortization	31. Memory Total / Amount/Start Date
15. Tax 2/Future Value	32. Memory Subtraction / Interest/End Date
16. Back Space	33. Memory Addition / Months/# of Days
17a. Item Count	34. Memory Subtotal / Payment/Compute
18. Sign Change	

This section describes the mode switches, data entry keys, and operating keys provided on your calculator. The following terms are used in discussing your calculator's operation:

- The **accumulator** is the area of the calculator's logic that stores a running total of the results of addition and subtraction operations. It is the "adding machine" portion of the calculator.
- The **calculating register** is the area of the calculator's logic where the intermediate and final results of multiplication, division and percentage calculations are stored. The contents of the calculating register do not affect the accumulator.
- The **keyboard register** is the area of the calculators logic that stores the value that will immediately be used in the next calculation.
- The **item count register** is the area of the calculator's logic that counts your entries into the accumulator. Each positive entry is counted as one item. Each Negative entry is subtracted resulting in a net item count. It is also net or gross programmable.
- The **memory register** is the area of the calculator's logic that accumulates amounts you add to or subtract from the memory. Because the memory register is

independent of the accumulator and the calculating register, it retains its value until you clear it with the Memory Total (MT) key.

SLIDE SWITCH FEATURES

This section illustrates and describes the mode switches you can use to control your calculator's operation.

1. ↓ 5/4 ↑ Decimal Rounding Selector

↓ This causes automatic round down (truncation).

5/4 This setting causes automatic round off. If the last digit of the result that will be printed or printed/displayed upon rounding is followed by a value of 0 to 4, the digit is unchanged. If the last digit of the result that will be printed or printed/displayed upon rounding is followed by a value of 5 to 9, the digit is rounded up.

↑ This setting causes automatic round up

2. • PRINT Printer Select Switch

• (Non-print) Printer is activated only when feed key or non-add/date key is pressed.

PRINT Printer is activated as long as calculator is turned on.

3. + 0 1 2 3 4 6 F Decimal Point Selector

+ Monetary Add Mode: At this setting, amounts entered are assumed to be monetary. The calculator automatically supplies a decimal point to the left of the last two digits entered. Use this setting to add, subtract, multiply and divide decimals.

Units/price mode operation:

Multiplication: The first factor will be entered as a whole number and the second factor will have a decimal point supplied to the left of the last two digits.

Division: The first factor will have a decimal point supplied to the left of the last two digits and the second factor will be entered as a whole number.

0,1,2,3,4,6 Fixed decimal point mode; these settings specify the number of digits to the right of the decimal point that are shown in the result.

F Floating decimal point mode; this setting specifies that all digits of the result are shown, up to a maximum of 10 on model 1530-6, and 12 on model 1560-6 and 14 on model 1570-6. If the result exceeds these capacities, excess digits to the right of the decimal point are dropped. No rounding takes place.

4. • F-Cal Financial Calculation Switch

• Without Financial Calculation

F-Cal Tax 1 key change to Amortization key

Tax 2 Key change to FV key
 Memory Total key change to Amount key
 Memory Minus key change to Interest key
 Memory Plus key change to Months key
 Memory Subtotal key change to Payment key

Note: Cost-Sell-Margin is disabled when in this mode.

5. • Σ /Loan FV Sigma/Loan and Futre Value Switch

F-Cal=Off • work as **Sigma off**

 Σ work as **Sigma on**

F-Cal = ON • work as **Loan**

 Σ work as **FV**

Σ
 (Sigma On) When the Sigma switch is in the “ Σ ” position, the results of multiplication or division calculations completed by the = or % key are automatically added to the accumulator.

(Sigma Off) When the Sigma switch is in this position, the results of these calculations are not added to the accumulator. The sum of these accumulations is displayed by depressing the Subtotal key and are displayed and cleared by depressing the Total key.

Loan
 FV
 Basic Financial Calculation
 Calculation for Future Value

6. • GT Grand Total Switch

• Calculation without Grand Total

GT **1570-6:** Any total taken with **T** key is automatically accumulated to Grand Total memory. The accumulated grand total can be recalled by pressing the **IIT** key then the **T** key.

1560-6 & 1530-6: Any total taken with **T** key is automatically accumulated to memory. The accumulated grand total can be recalled by pressing the **MT** key.

NOTE: For model 1560-6 and 1530-6, when F-Cal switch is ON, Grand Total is inaccessible because MT is Amount Key.

7. \uparrow Paper Feed Key
 Advance the paper roll.

8. $\Delta\%$ Delta Percentage
 Automatically compares any two amounts and then calculates and prints the difference and percent of change.

9. TIME/DATE CAL Time/DATE Calculation Key
 Pressing this key once will set the calculator to Time Mode. +, -, S and T will be calculated and displayed in Time Mode (hours, minutes). A second depression will set the calculator and display to Date Mode

(MM-DD-YYYY). In Date mode, **MT** key changes to **Start Date** key, **M-** key changes to **End Date** key, **M+** key changes to **Number of Days** key and **MS** key changes to **Compute** key.

10. **[COST]**

Cost Key

Used to enter the Cost factor in a Gross Profit Margin calculation.

11. **[SELL]**

Sell Key

Used to enter the Selling price in a Gross Profit Margin calculation.

12. **[MARGIN]**

Margin Key

Used to enter the desired Margin in a Gross Profit Margin calculation.

13. **[RATE]**

TAX Rate Preset Key

Used to enter TAX rate.

14. **[TAX 1/Amortication]**

Tax 1/Amoritzation Key (dual operation)

Tax 1: Calculate an amount of tax with tax rate preset by **RATE** key. Use **+** key for calculating an amount including VAT, and **-** key for calculating an amount excluding VAT.

Amortization: Prints the amortization schedule for a period, selected range of periods or the complete term of the loan.

15. **[TAX 2/FV]**

Tax 2/Future Value Key (dual operation)

Tax 2: Calculate an amount of tax with tax rate preset by **RATE** key. Use **+** key for calculating an amount including VAT, and **-** key for calculating an amount excluding VAT.

FV: If this key is pressed after 10-key input, it means enter the value as FV. If Amount, Interest, Months and Payment are entered in prior, or modification is done on any of the three as above in prior, user can calculate/recalculate the FV by pressing this key.

16. **[→]**

Right Shift Key

Deletes right most character of a live entry.

17a. **[N]**

Item Count Key

Model 1570-6

Calculations with item count and/or averaging. Also used to set the N count to Gross or Net.

18. **[+/-]**

Sign Change Key

Reverse the sign on the display.

19. **[%+]**

Percent Key

Completes percent calculation when Multiple or Division key is used.

20. **[÷]**

Division Key

The Division key performs division, automatic constant division and intermediate sequential operations. It establishes the next amount as a constant divisor. The **÷** key also causes the calculator to divide when

you depress the =, %, **M+**, **M-**, **X** or **÷** key. Each divisor entry is retained as a constant (except **M+** and **M-** entries) until you depress the **X**, **÷** or Clear.

21. **[=]**

Equal Key

To get the result in multiplication or division.

22. **[X]**

Multiplication Key

The multiplication key performs multiplication, automatic constant multiplication and intermediate sequential operations. It establishes the amount entered or the previous printed or printed/displayed amount as a constant multiplicand. The **X** key also causes the calculator to multiply when you depress the =, %, **M+**, **M-**, **X** or **÷** key. Each multiplicand entry is retained as a constant (except **M+** and **M-** entries) until you depress the **X**, **÷**, or Clear.

23a. **[C/CE]**

Clear / Clear Entry Key

Model 1570-6

Clears a live entry by pressing this key once. Press twice to clear the accumulator or pending calculation. Does not clear the Memory or Grand total.

23b. **[CE]**

Clear Entry

Model 1560-6 & 1530-6

Clears a live entry.

24. **[TIME/DATE]**

Time and Date Display Key

Used to display or program the date and time. Depressing this key once will cause the date to display, a second depression will display the time. Holding the key down for three seconds will cause the date or time to flash, this is the program mode.

25. **[0]-[9], [00] & [.]** **Numeric Keys**

The calculator uses the conventional 10-key indexing keyboard, and includes the double zero key and decimal point key. Whole numbers are entered exactly as they are written.

26. **[−]**

Minus Key

Subtracts an amount from the accumulator. To subtract the same amount more than one time (repeat subtraction), enter that amount once and depress the Minus key as many times as necessary. If this key is depressed immediately after [%] key, it works as percent minus key.

27. **[+]**

Plus Key

Adds an amount to the accumulator. To add the same amount more than one time (repeat addition), enter that amount once and depress the Plus key as many times as necessary. If this key is depressed immediately after [%] key, it works as percent plus key.

28a. **[IIT]**

Memory II Selector Key

Model 1570-6

Calculation on memory II by press Memory II key follow by plus, minus, subtotal or total key.

28b. **[N]**

Item Count Key

Model 1560-6 & 1530-6

Calculations with item count and/or averaging. Also used to set the N count to Gross or Net.

29. **[# / S]**

Date / Subtotal Key

: It will print live entry as an identifier as an invoice number with “#” mark.

S : It prints but does not clear the accumulator.

30. **[T]**

Total Key

Prints and clears the accumulator. When this key is pressed with the “GT” switch is on, the result is accumulated automatically in the memory register.

31. **[MT / Amount/Start Date] Memory Total Key / Amount Start Date (Dual Operation)**

MT: Prints and clears the memory.

Amount: When you are in Financial Mode and this key is used to enter the principal amount of the loan. However, if Interest, Month, and Payment have previously been entered this key will produce the principal amount.

Start Date: Used to enter start date. Entry must follow format (MM-DD-YYYY)

32. **[M- / Interest/End Date] Memory Minus Key / Interest /End Date (Dual Operation)**

M-: Subtracts an amount from memory. If there is a live calculation pending, the Memory Minus key will complete the calculation and subtract the amount from Memory.

Interest: This key will enter the 10-key input value as Loan Interest. Loan Interest must be entered in order to do any financial calculation. Therefore, this key will only be able to use for recall Loan Interest, or enter the 10-key value.

End Date: Used to enter end date. Entry must follow (MM-DD-YYYY)

33. **[M+ / Months/ # of Days] Memory Plus Key / Months/# of days (Dual Operation)**

M+: Adds an amount to memory. If there is a live calculation pending, the Memory plus key will complete the calculation and accumulate the result to Memory.

Months: If this key is pressed after 10-key input, it means enter the value as Number of Months to settle the Loan. If Amount, Interest, and Payment are entered in prior, or modification is done on any of the three as above in prior, user can calculate / recalculate the Number of Months

of Days: Used to calculate two different dates. If days is not change sign that is calculate future date. If days is change sign that is calculate past date.

**34. [MS / Payment/Compute] Memory Subtotal Key / Payment/Compute
(Dual Operation)**

MS: Prints but do not clear the memory.

Payment: If this key is pressed after 10-key input, it means enter the value as Payment. If Amount, Interest, and Months are entered in prior, or modification is done on any of the three as above in prior, user can calculate / recalculate the Payment by press this key.

Compute: Calculate days between dates, future date and past date

35. [÷], [=] R Square Root
By depressing the ÷ and then the = key the square root result will be achieved.

Troubleshooting

Many problems such as no power, no key response etc. Can be resolved using the RESET button. Please follow these instructions:

1. Machine must be plugged in and ON, and in the PRINT mode.
2. Turn machine over so you can see the battery compartment.
3. Open the battery compartment and locate the RESET button located next to the silver battery.
4. Depress the RESET button; you will hear the machine cycle. If you do not hear the machine recycle, push the button a 2nd time.
5. Replaced the battery compartment cover and turn the machine right side up.
6. Test the machine.

If this procedure has not successfully resolved your problem please call 800-628-2420 for further assistance.

French:

Plusieurs problèmes tels que le manqué d'alimentation électrique, le manqué de réaction des touches du clavier, etc. peuvent être résolues en appuyant sur le bouton de réenclenchement. Pour ce faire, veuillez suivre les consignes suivantes.

1. La calculatrice doit être mise sous tension et sous le mode imprimer (PRINT).
2. Retourner la calculatrice afin de voir le compartiment des piles qui se trouve en-dessous.
3. Ouvrir le compartiment des piles et localiser le bouton de réenclenchement (RESET) près de la pile argentée.
4. Appuyer sur le bouton de réenclenchement, vous entendrez le cycle de la calculatrice. Si vous ne l'entendez pas, appuyez sur le bouton une deuxième fois.
5. Refermer le compartiment des piles et retourner la calculatrice.
6. Faites l'essai de votre calculatrice.

Si ces consignes n'ont pas réglé le problème de votre calculatrice, veuillez communiquer avec la compagnie VICTOR au 1-800-628-2420 pour tout renseignement supplémentaire.

Spanish:

Muchos problemas tales como falta de potencia, ninguna respuesta de las teclas etc. puede ser resueltos usando el botón del reajuste. Siga por favor estas instrucciones.

1. La maquina debe de estar enchufada, prendida, y en el modo de impresion.
2. Devuelve la calculadora poca bajo, para ver el compartimiento de la batería.
3. Abra el compartimiento de batería y localice el botón del reajuste, situado al lado de la batería de plata.
4. Presione el botón del reajuste, usted debe de oír el ciclo de la maquina. Si usted no oye la maquina reciclar presione el botón una Segunda vez.
5. Sustituye la cubierta del compartimiento de batería y devuelve la maquina poca arriba.
6. Pruebe la maquina.

Si este procedimiento no ha dado resultados con su problema, por favor llame a: 001-877-628-2420, para ayuda adicional.

Application Examples

Ejemplos de Aplicacion

Exemples d'Application

English – Spanish – French

1. Backspace – Retroceso – Rappel Arrière

	<u>Rounding</u> 5/4	<u>Print</u> P	<u>Decimal</u> 4	<u>F-Cal</u> .	<u>Σ</u> .	<u>GT</u> .
Problem Problema Problème		Enter Apriete Appuyer Sur		Display Desplegado Afficher		Paper Papel Bande
5.4321 + 2.34567 = ?		5.4321 2.3457 67	[+] [→] [+] [T]	5.4321 2.345 7.77777 7.7778		5.4321 + 2.34567 + 7.7778 T

2. Rounding for Addition/Subtraction – Redondeo para Adicion/Sustraccion- Arrondi pour l'addition/soustraction

	<u>Rounding</u> ↓	<u>Print</u> P	<u>Decimal</u> 0	<u>F-Cal</u> .	<u>Σ</u> .	<u>GT</u> .
Problem Problema Problème		Enter Apriete Appuyer Sur		Display Desplegado Afficher		Paper Papel Bande
3.4 + 2.1 = ?		3.4 2.1	[+] [+] [T]	3.4 5.5 5.		3.4 + 2.1 + 5. T

	<u>Rounding</u> 5/4	<u>Print</u> P	<u>Decimal</u> 0	<u>F-Cal</u> .	<u>Σ</u> .	<u>GT</u> .
Problem Problema Problème		Enter Apriete Appuyer Sur		Display Desplegado Afficher		Paper Papel Bande
3.4 + 2.1 = ?		3.4 2.1	[+] [+] [T]	3.4 5.5 6.		3.4 + 2.1 + 6. T

3. Addition & Subtraction – Adicion Y Sustraccion – Addition et Soustraction

Rounding Print Decimal F-Cal Σ GT
 5/4 P F . . .

Problem
Problema
Problème

Enter
Apriete
Appuyer Sur

Display
Desplegado
Afficher

Paper
Papel
Bande

2 + 3.1415926 – 6=?

2	[+]	2.
3.1415926	[+]	5.1415926
6	[-]	- 0.8584074
	[T]	- 0.8584074

2.	+
3.1415926	+
6.	-
0.8584074	-T

4. Addition/Subtraction in Add Mode – Adicion/Sustraccion en modo para Anadir– Addition/soustraction en mode monétaire

Rounding Print Decimal F-Cal Σ GT
 5/4 P + . . .

Problem
Problema
Problème

Enter
Apriete
Appuyer Sur

Display
Desplegado
Afficher

Paper
Papel
Bande

1.23 – 4.56 + 7.89 = ?

123	[+]	1.23
456	[-]	- 3.33
	[#/S]	- 3.33
789	[+]	4.56
	[T]	4.56

1.23	+
4.56	-
3.33	-S
7.89	+
4.56	T

**5. Item Count Presetting – Preestableciendo el contador de partidas –
Programmation du compteur d'articles**

<u>Rounding</u>	<u>Print</u>	<u>Decimal</u>	<u>F-Cal</u>	Σ	<u>GT</u>
5/4	P	+	.	.	.

**The Item Count is Programmable for Gross Count or Net Count
Contador de Partidos es programmable para Contador bruto ó
contador neto.**

La programmation du compteur d'articles peut être brute ou nette.

Gross Item Count: All entries both Positive (+) and Negative (-)
increment the counter positively.

Contador de Partidas Bruto: Todas las entradas positivos y negativos
incrementan el contador positivamente.

Programmation brute: Toute entrée positive ou négative augmente le
compteur positivement.

Example: $10 + 2 + 3 - 5 = 10$ **Item count is 4**

Net Item Count: Plus entries increment the counter, minus entries
decrement the counter.

Contador de Partidas Neto: Entradas de sumar incrementan el
contador, entradas de restar
decrementan el contador.

Programmation nette: Les entrées positives augmentent le compteur
et les entrées négatives diminuent le compteur.

Example: $10 + 2 + 3 - 5 = 10$ **Item count is 2**

<u>Problem</u> <u>Problema</u> <u>Problème</u>	<u>Enter</u> <u>Apriete</u> <u>Appuyer Sur</u>	<u>Display</u> <u>Desplegado</u> <u>Afficher</u>
Setting Item Estableciendo el artículo	[C/CE] [N] (Press & Hold 3 sec) (Presione y aguante por 3 seg)	0. (Blinking) 000. (Parpadeando)
Gross Item Count	[+] [C/CE]	000. 0.
Setting Item Estableciendo el artículo	[N] (Press & Hold 3 sec) (Presione y aguante por 3 seg)	(Blinking) 000. (Parpadeando)
Net Item Count Contador de Partidas Neto	[-]	000.

6. (A) Addition/Subtraction with Item Count in Gross Setting
Adicion/Sustraccion con Contador de Partidas en Modo Bruto
Addition/soustraction avec compteur brut d'item

Rounding Print Decimal F-Cal Σ GT
 5/4 P + . . .

Problem
Problema
Problème

Enter
Apriete
Appuyer Sur

Display
Desplegado
Afficher

Paper
Papel
Bande

11.32 + 7.98-33.33=?

1132	[+]	11.32
798	[+]	19.30
	[N]	⁰ 002.
	[#/S]	19.30
3333	[-]	- 14.03
	[N]	⁰ 003.
	[T]	- 14.03
	[C/CE]	0.

	11.32 +
	7.98 +
002	19.30 S
	33.33 -
003	14.03 -T
	0. C

6. (B) Addition/Subtraction with Item Count in Net Setting
Contador de partidas en modo neto
Addition/soustraction avec compteur net d'item

Rounding Print Decimal F-Cal Σ GT
 5/4 P + . . .

Problem
Problema
Problème

Enter
Apriete
Appuyer Sur

Display
Desplegado
Afficher

Paper
Papel
Bande

11.32 + 7.98-33.33=?

1132	[+]	11.32
798	[+]	19.30
	[N]	⁰ 002.
	[#/S]	19.30
3333	[-]	- 14.03
	[N]	⁰ 001.
	[T]	- 14.03
	[C/CE]	0.

	11.32 +
	7.98 +
002	19.30 S
	33.33 -
001	14.03 -T
	0. C

6. (C) Item Count with Averaging
Contador de partidas con promedio
Moyenne avec compteur d'item

Rounding Print Decimal F-Cal Σ GT
 5/4 P + . . .

<u>Problem</u> <u>Problema</u> <u>Problème</u>	<u>Enter</u> <u>Apriete</u> <u>Appuyer Sur</u>	<u>Display</u> <u>Desplegado</u> <u>Afficher</u>	<u>Paper</u> <u>Papel</u> <u>Bande</u>
123+456+789+987=?	123 [+]	1.23	1.23 +
	456 [+]	5.79	4.56 +
	789 [+]	13.68	7.89 +
	987 [+]	23.55	9.87 +
	[T]	23.55	23.55 T
	[N]	0004	
	[N]	5.89	5.89 *
			004

7. Grand Total Memory
Memoria Del Gran Total
Mémoire de Total général

A. Model 1570-6

Rounding Print Decimal F-Cal Σ GT
 5/4 P + . . GT

<u>Problem</u> <u>Problema</u> <u>Problème</u>	<u>Enter</u> <u>Apriete</u> <u>Appuyer Sur</u>	<u>Display</u> <u>Desplegado</u> <u>Afficher</u>	<u>Paper</u> <u>Papel</u> <u>Bande</u>
13.20 9.55	[C/CE]	0.	0. C
8.30 7.36	13.2 [+]	13.20	13.20 +
<u>2.95</u> <u>18.33</u>	8.3 [+]	21.50	8.30 +
24.45 +35.24	2.95 [+]	24.45	2.95 +
	[T] II	24.45	24.45 T+
	9.55 [+]	9.55	9.55 +
	7.36 [+]	16.91	7.36 +
	18.33 [+]	35.24	18.33 +
	[T] II	35.24	35.24 T+
	[IIT] II	35.24	
	[T] II	59.69	59.69 M II T

B. Model 1530-6, 1560-6

<u>Rounding</u> 5/4	<u>Print</u> P	<u>Decimal</u> +	<u>F-Cal</u> .	<u>Σ</u> .	<u>GT</u> GT
<u>Problem</u> <u>Problema</u> <u>Problème</u>	<u>Enter</u> <u>Apriete</u> <u>Appuyer Sur</u>		<u>Display</u> <u>Desplegado</u> <u>Afficher</u>		<u>Paper</u> <u>Papel</u> <u>Bande</u>
13.20 9.55		[C/CE]	0.		0. C
8.30 7.36	13.2	[+]	13.20		13.20 +
<u>2.95</u> <u>18.33</u>	8.3	[+]	21.50		8.30 +
24.45 +35.24 = T	2.95	[+]	24.45		2.95 +
		[T]	24.45	M	24.45 MT+
	9.55	[+]	9.55	M	9.55 +
	7.36	[+]	16.91	M	7.36 +
	18.33	[+]	35.24	M	18.33 +
		[T]	35.24	M	35.24 MT+
		[MT]	59.69		59.69 MT

8. Repetitive Calculation with Reference to Date
Repetición de la adición y sustracción con una fecha de referencia
Répéter addition et soustraction avec une référence de date

Reference date is April 25, 2005

La fecha referencia es 25, Abril, 2005

La date reference est 25, Avril, 2005

<u>Rounding</u> 5/4	<u>Print</u> P	<u>Decimal</u> +	<u>F-Cal</u> .	<u>Σ</u> .	<u>GT</u> GT
<u>Problem</u> <u>Problema</u> <u>Problème</u>	<u>Enter</u> <u>Apriete</u> <u>Appuyer Sur</u>		<u>Display</u> <u>Desplegado</u> <u>Afficher</u>		<u>Paper</u> <u>Papel</u> <u>Bande</u>
6.54 + 6.54 + 6.54 -	04.25.2005	[#/S]	4.25.2005		# 4.25.2005
7.89 - 7.89 = ?	654	[+]	6.54		6.54 +
		[+]	13.08		6.54 +
		[+]	19.62		6.54 +
	789	[-]	11.73		6.54 +
		[-]	3.84		7.89 -
		[T]	3.84		7.89 -
					3.84 T

9. Multiplication
Multiplicación
Multiplication

	<u>Rounding</u> ↓	<u>Print</u> P	<u>Decimal</u> 2	<u>F-Cal</u> .	<u>Σ</u> .	<u>GT</u> .
Problem Problema Problème	Enter Apriete Appuyer Sur		Display Desplegado Afficher		Paper Papel Bande	
1.238 x 456 =?	1.238 456	[X] [=]	1.238 456. 564.52		1.238 X 456.00 = 564.52 *	

10. Sequential (Chain) Multiplication
Multiplicación secuencial (en cadena)
Multiplication Sequentielle (Chaine)

	<u>Rounding</u> ↑	<u>Print</u> P	<u>Decimal</u> 3	<u>F-Cal</u> .	<u>Σ</u> .	<u>GT</u> .
Problem Problema Problème	Enter Apriete Appuyer Sur		Display Desplegado Afficher		Paper Papel Bande	
3.21 X 4.5 X 6.324 = ?	3.21 4.5 6.324	[X] [X] [=]	3.21 3.210 4.5 14.445 6.324 91.351		3.210 X 4.500 X 6.324 = 91.351 *	

11. Constant Multiplication
Multiplicación constante
Multiplication par une constante

	<u>Rounding</u> 5/4	<u>Print</u> P	<u>Decimal</u> 2	<u>F-Cal</u> .	<u>Σ</u> .	<u>GT</u> .
Problem Problema Problème	Enter Apriete Appuyer Sur		Display Desplegado Afficher			Paper Papel Bande
2 X 4 = 8, 2 x 5 = 10	2		2.			2.00 X
2 x 6 = 12		[X]	2.00			4.00 =
	4		4.			8.00 *
		[=]	8.00			5.00 =
	5		5.			10.00 *
		[=]	10.00			6.00 =
	6		6.			12.00 *
		[=]	12.00			

12. Constant Multiplication with Accumulation
Multiplicación constante can Acumulación
Multiplication par une constante avec accumulation

	<u>Rounding</u> 5/4	<u>Print</u> P	<u>Decimal</u> 2	<u>F-Cal</u> .	<u>Σ</u> Σ	<u>GT</u> .
Problem Problema Problème	Enter Apriete Appuyer Sur		Display Desplegado Afficher			Paper Papel Bande
\$1.79 x 167 = \$298.93	1.79		1.79			1.79 X
1.79 x -230 = -411.70		[X]	1.79			167.00 =
1.79 x 104 = +186.16 = ?	167		167.			298.93 +
		[=]	298.93			230.00 - =
	230		230.			411.70 - +
		[+/-]	-230.			104.00 =
		[=]	-411.70			186.16 +
	104		104.			73.39 T
		[=]	186.16			
		[T]	73.39			

13. Division – División – Division

<u>Problem</u> <u>Problema</u> <u>Problème</u>	<u>Rounding</u> ↓	<u>Print</u> P	<u>Decimal</u> 3	<u>F-Cal</u> .	<u>Σ</u> .	<u>GT</u> .
		<u>Enter</u> <u>Apriete</u> <u>Appuyer Sur</u>		<u>Display</u> <u>Desplegado</u> <u>Afficher</u>		<u>Paper</u> <u>Papel</u> <u>Bande</u>
178 ÷ 6 =?		178		178.		178.000 ÷ 6.000 = 29.666 *
			[+]	178.000		
		6		6.		
			[=]	29.666		

14. Constant Division – División Constante – Division par une constante

<u>Problem</u> <u>Problema</u> <u>Problème</u>	<u>Rounding</u> 5/4	<u>Print</u> P	<u>Decimal</u> 2	<u>F-Cal</u> .	<u>Σ</u> .	<u>GT</u> .
		<u>Enter</u> <u>Apriete</u> <u>Appuyer Sur</u>		<u>Display</u> <u>Desplegado</u> <u>Afficher</u>		<u>Paper</u> <u>Papel</u> <u>Bande</u>
755 ÷ 4 = 188.75		755		755.		755.00 ÷ 4.00 = 188.75 * 409.00 = 102.25 * 32.00 = 8.00 *
409 ÷ 4 = 102.25			[+]	755.00		
32 ÷ 4 = 8.00		4		4.		
			[=]	188.75		
		409		409.		
			[=]	102.25		
		32		32.		
			[=]	8.00		

15. Division with Accumulation
División con Acumulación
Division avec Accumulation

	<u>Rounding</u> 5/4	<u>Print</u> P	<u>Decimal</u> 4	<u>F-Cal</u> .	Σ Σ	<u>GT</u> .
<u>Problem</u> <u>Problema</u> <u>Problème</u>	<u>Enter</u> <u>Apriete</u> <u>Appuyer Sur</u>		<u>Display</u> <u>Desplegado</u> <u>Afficher</u>		<u>Paper</u> <u>Papel</u> <u>Bande</u>	
145 ÷ 12.25 + 15130 ÷	145		145.		145.0000 ÷	
123.50 + 159.36 ÷		[+]	145.0000		12.2500 =	
10.25=?	12.25		12.25		11.8367 +	
		[=]	11.8367			
	15130		15,130.		15,130.0000 ÷	
		[+]	15,130.0000		123.5000 =	
	123.50		123.50		122.5101 +	
		[=]	122.5101			
	159.36		159.36		159.3600 ÷	
		[+]	159.3600		10.2500 =	
	10.25		10.25		15.5473 +	
		[=]	15.5473			
		[T]	149.8941		149.8941 T	

16. Units/Price Calculations
Cálculo de precio de unidades
Calculs Unités / Prix

Rounding Print Decimal F-Cal Σ GT
 5/4 P + . Σ .

Problem Problema Problème	Enter Apriete Appuyer Sur		Display Desplegado Afficher	Paper Papel Bande
132 X \$ 5.67 = \$748.44	132		132.	132.00 X
146 X \$4.45 = \$649.70		[X]	132.00	5.67 =
155 X \$3.11 = \$482.05	567		567.	748.44 +
T = ?		[=]	748.44	
	146		146.	146.00 X
		[X]	146.00	4.45 =
	445		445.	649.70 +
		[=]	649.70	
	155		155.	155.00 X
		[X]	155.00	3.11 =
	311		311.	482.05 +
		[=]	482.05	
		[T]	1,880.19	1,880.19 T

17. Tax Rate Presetting
Preestablecimiento del valor del impuesto
Programmation du taux de taxe

Rounding Print Decimal F-Cal Σ GT
 ↑ P 2 . . .

Problem Problema Problème	Enter Apriete Appuyer Sur	Display Desplegado Afficher	Paper Papel Bande
Preset TAX 1 = 7.5%		[C/CE] or [C]	0. C
	Press & Hold 3 sec (Presione y aguante por 3 seg)	[RATE]	Blinking Parpadeando
	7.5	[TAX 1]	7.50
Preset TAX 2 = 18.6%		[C/CE] or [C]	0. C
	Press & Hold 3 sec (Presione y aguante por 3 seg)	[RATE]	Blinking Parpadeando
	18.6	[TAX 2]	18.60

18. Tax Calculation
Calculo del Impuesto
Calcul de la taxe

	<u>Rounding</u>	<u>Print</u>	<u>Decimal</u>	<u>F-Cal</u>	<u>Σ</u>	<u>GT</u>
	↑	P	2	.	.	.
Problem Problema Problème		Enter Apriete Appuyer Sur		Display Desplegado Afficher		Paper Papel Bande
Price without TAX 1 =261.56			[C/CE] or [C]	0.		0. C 261.56
Precio Sin [TAX 1] =		261.56	[TAX 1]	261.56	...1...	7.50 % 19.62 Δ 281.18 *
Prix sans taxe						
Price with TAX 1 =	?		[+]	281.18		281.18
Precio con [TAX 1]					...1...	7.50 % 19.62 Δ 261.56 *
Prix avec taxe			[TAX 1]	281.18		
			[-]	261.56		
Price without TAX 2 =300			[C/CE] or [C]	0.		0. C 300.00
Precio Sin [TAX2] =		300	[TAX 2]	300.	...2...	18.60 % 55.80 Δ 355.80 *
Prix sans taxe						
Price with TAX 2 =	?		[+]	355.80		355.80
Precio con [TAX2] =					...2...	18.60 % 55.80 Δ 300.00 *
Prix avec taxe						
Price without TAX 2			[TAX2]	355.80		
Precio sin [TAX 2]			[-]	300.00		
Prix sans taxe						
VAT including TAX 1 and TAX 2		200	[TAX 1]	200.	...1...	200.00
IVA incluyendo [TAX 1] y [TAX2]			[TAX 2]	200.	...2...	7.50 % 15.00 Δ
Prix avec taxe			[+]	252.20	...2...	18.60 % 37.20 Δ
Price Excluding TAX 1 and TAX 2			[TAX 1]	252.20	...1,2...	52.20 Δ 252.20 *
Precio excluyendo [TAX1] y [TAX2]			[TAX 2]	252.20		
Prix sans taxe			[-]	200.00		
					...1...	252.20
					...2...	7.50 % 15.00 Δ
					...1,2...	18.60 % 37.20 Δ
						52.20 Δ 200.00 *

NOTE: TAX calculation is fixed to 2 decimal points and the result will be rounded up.

NOTA: El calculo del impuesto esta fijado a 2 puntos decimales y el resultado sera redondeado para arriba.

NOTE: Le calcul de la taxe sera fixé avec 2 décimales après le point et le résultat sera arrondi.

19. Percent Add On
Adicion del porcentaje
Ajout pour cent

	<u>Rounding</u> ↓	<u>Print</u> P	<u>Decimal</u> 2	<u>F-Cal</u> .	<u>Σ</u> .	<u>GT</u> .
Problem Problema Problème		Enter Apriete Appuyer Sur		Display Desplegado Afficher		Paper Papel Bande
Price	\$ 3.95	3.95		3.95		3.95 X
Tax	5%		[X]	3.95		5.00 %
Tax Amount	\$.19	5		5.		0.19 *
Net Amount	\$ 4.14		[%±]	0.19		4.14 +%
Precio	\$ 3.95		[+]	4.14		
Impuesto	5%					
Cantidad de impuesto	\$.19					
Cantidad neta	\$ 4.14					
Prix	\$ 3.95					
Montant de Taxe	5%					
Taxe	\$.19					
Montant Net	\$ 4.14					

20. Percent Discount
Porcentaje de descuento
Rabais en pour cent

	<u>Rounding</u> 5/4	<u>Print</u> P	<u>Decimal</u> 2	<u>F-Cal</u> .	<u>Σ</u> .	<u>GT</u> .
<u>Problem</u> <u>Problema</u> <u>Problème</u>		<u>Enter</u> <u>Apriete</u> <u>Appuyer Sur</u>		<u>Display</u> <u>Desplegado</u> <u>Afficher</u>		<u>Paper</u> <u>Papel</u> <u>Bande</u>
Price	\$ 169.50	169.5		169.5		169.50 X
Discount	14%		[X]	169.50		14.00 %
Discount Amount	\$ 23.73	14		14.		23.73 *
Net Amount	\$ 145.77		[%±]	23.73		
Precio	\$ 169.50		[-]	145.77		
Descuento	14%					145.77 -%
Cantidad descontado	\$ 23.73					
Canatidad neta	\$ 145.77					
Prix	\$ 169.50					
Rabais	14%					
Montant Rabais	\$ 23.73					
Montant Net	\$ 145.77					

21. Chain Discount with Total Amount of Discount
Descuento en cadena con cantidad total de descuento
Réduction en chaîne avec montant total de la réduction

	<u>Rounding</u> 5/4	<u>Print</u> P	<u>Decimal</u> 2	<u>F-Cal</u> .	<u>Σ</u> .	<u>GT</u> .
<u>Problem</u> <u>Problema</u> <u>Problème</u>		<u>Enter</u> <u>Apriete</u> <u>Appuyer Sur</u>		<u>Display</u> <u>Desplegado</u> <u>Afficher</u>		<u>Paper</u> <u>Papel</u> <u>Bande</u>
\$23.15 less 15/10/5% = \$16.82 Net		23.15		23.15		23.15 M+
Total Amount of Discount \$6.33			[M+] I	23.15		23.15 X
			[X] I	23.15		15.00 %
\$23.15 menos 15/10/5% = \$16.82 neto		15		15.		3.47 *
Cantidad total de Descontar \$6.33			[%±] I	3.47		19.68 -%
			[-] I	19.68		
\$23.15 moins 15/10/5% = \$16.82 net			[X] I	19.68		19.68 X
Montant Total de Reduction \$6.33		10		10.		10.00 %
			[%±] I	1.97		1.97 *
			[-] I	17.71		17.71 -%
			[X] I	17.71		
		5		5.		17.71 X
			[%±] I	0.89		5.00 %
			[-] I	16.82		0.89 *
			[M-] I	16.82		
			[MT]	6.33		16.82 -%
						16.82 M-
						6.33 MT

22. Percent Change and Amount of Difference
Cambio de porcentaje y cantidad de diferencia
Changement en pour cent et montant de la différence

	<u>Rounding</u> 5/4	<u>Print</u> P	<u>Decimal</u> 2	<u>F-Cal</u> .	<u>Σ</u> .	<u>GT</u> .
<u>Problem</u> <u>Problema</u> <u>Problème</u>		<u>Enter</u> <u>Apriete</u> <u>Appuyer Sur</u>		<u>Display</u> <u>Desplegado</u> <u>Afficher</u>		<u>Paper</u> <u>Papel</u> <u>Bande</u>
Last Year's Expense	\$ 60.00	60		60.		60.00 Δ 130.00 = 70.00 Δ * 116.67 Δ%
This Year's Expense	\$130.00		[Δ%]	60.00		
Amount of Difference	\$ 70.00	130		130.		
Percent of Change	116.67%		[=] or [%±]	116.67		
Gastos del ano anterior	\$ 60.00					
Gastos del presente ano	\$130.00					
Cantidad de diferencia	\$ 70.00					
Cambio del porcentaje	116.67%					
Depense de l'annee derniere	\$ 60.00					
Depense de cette annee	\$130.00					
Montant de la Difference	\$ 70.00					
Pour cent de changement	116.67%					

23. Constant Percent Change and Amount of Difference
Cambio del porcentaje y cantidad de diferencia constantes
Changement en pour cent constant et montant de la différence

Rounding Print Decimal F-Cal Σ GT
 5/4 P 2 . . .

Problem Problema Problème	Enter Apriete Appuyer Sur	Display Desplegado Afficher	Paper Papel Bande
Last Year's Expense	\$125,000	125000	125,000.00 Δ
This Year's Expense	\$175,000	[Δ%]	175,000.00 =
Next Year's Expense	\$210,000	175000	50,000.00 Δ*
Percent of Change	?	[=]	40.00 Δ%
Amount of Difference	?	210000	210,000.00 =
Gastos del ano anterior	\$125,000	[=]	68.00 Δ*
Gastos del presente ano	\$175,000		85,000.00 Δ*
Gastos del año siguiente	\$210,000		68.00 Δ%
Cambio del porcentaje	?		
Cantidad de diferencia	?		
Depense de l'annee derniere	\$125,000		
Depense de cette annee	\$175,000		
Next Year's Expense	\$210,000		
Pour cent de changement	?		
Montant de la Difference	?		

24. Gross profit Margin Calculation COST-SELL-MARGIN
Càlculo del margen de beneficios gruesos COSTO-VENTA-MARGEN
Calcul de marge bénéficiaire brute MARGE-COUT-VENTE

	<u>Rounding</u> 5/4	<u>Print</u> P	<u>Decimal</u> 0	<u>F-Cal</u> .	<u>Σ</u> .	<u>GT</u> .
Problem Problema Problème		Enter Apriete Appuyer Sur		Display Desplegado Afficher		Paper Papel Bande
Cost = 100, Margin = 20%, Sell = ?		100	[COST]	100.		100. C
Cost = 100, Sell = 125, Margin = ?		20	[MARGIN]	125.		20. M%
Sell = 125, Margin = 20%, Cost = ?						25. Δ*
						125. S
Costo=100,Margen 20%,Venta=?		100	[COST]	100.		
Costo=100,Venta=125,Margen=?		125	[SELL]	20.		100. C
Venta=125,Margen=20%,Costo=?						125. S
						25. Δ*
Cout = 100,Marge = 20%, Vente=?		125	[SELL]	125.		20. M%
Cout =100, Vente=125, Marge = ?		20	[MARGIN]	100.		
Vente =125, Marge=20%, Cout = ?						125. S
						20. M%
						25. Δ*
						100. C

25. Square Root – You can use the ÷ and = keys to calculate square root
Càlculo de la raiz cuadrada – Para calcular la raiz cuadrada puede utilizar las teclas ÷ y =
Racine carreeé – Vous pouvez utiliser les touches ÷ et = pour calculer la racine carreeé.

	<u>Rounding</u> 5/4	<u>Print</u> P	<u>Decimal</u> 2	<u>F-Cal</u> .	<u>Σ</u> .	<u>GT</u> .
Problem Problema Problème		Enter Apriete Appuyer Sur		Display Desplegado Afficher		Paper Papel Bande
 58 = 7.62		58		58.		58.00 ÷
			[÷]	58.00		58.00 R
			[=]	7.62		7.62 *

26. Markdown and Selling Price
Reduccion y precio de venta
Escompte et prix de vente

Rounding Print Decimal F-Cal Σ GT
 5/4 P 2 . . .

Problem
Problema
Problème

Enter
Apriete
Appuyer Sur

Display
Desplegado
Afficher

Paper
Papel
Bande

Item Cost	\$ 100.00	100.00	[COST]	100.00
Markdown (Percent) (Based on to be determined selling price)	6.5 %	6.5	[+/-]	-6.5
Markdown (AMOUNT)	\$ 6.10			
Selling Price	\$ 93.90		[MARGIN]	93.90

100.00	C
6.50	M%
6.10	Δ*
93.90	S

Costo del articulo	\$ 100.00
Reduccion (Porcentaje) (Basandose en el precio de venta por determinar)	6.5 %
Reduccion (cantidad)	\$ 6.10
Precio de venta	\$ 93.90

Coût de l'article	\$ 100.00
Escompte (Pour cent) (Basé sur le prix de vente à déterminer)	6.5 %
Escompte (Montant)	\$ 6.10
Prix de vente	\$ 93.90

27. Invoice –Invoice Number 88901; Date 11/5/03
Factura – Numera de factura 88901; Fecha 11/5/03
Facture – Numéro de facture 88901; Date 11/5/03

			<u>Rounding</u>	<u>Print</u>	<u>Decimal</u>	<u>F-Cal</u>	$\frac{\Sigma}{\Sigma}$	<u>GT</u>
			5/4	P	+	.	Σ	.
<u>Problem</u>			<u>Enter</u>			<u>Display</u>		
<u>Problema</u>			<u>Apriete</u>			<u>Desplegado</u>		
<u>Problème</u>			<u>Appuyer Sur</u>			<u>Afficher</u>	<u>Paper</u>	
<u>Quantity</u>	<u>Price</u>	<u>Net</u>					<u>Papel</u>	
Cantidad	Precio	Neto	88901		88901.		#88901	
Quantite	Prix	Net	11.5.05		88,901.		#11.05.05	
16	3.29	52.64			11.505		16.00 X	
108	1.39	<u>150.12</u>	16		16.		3.29 =	
Gross,Grueso,Brut		202.76			[x]		52.64 +	
Less 10% discount					3.29			
Menos 10% descuento			3.29		3.29			
Moins Rabais de 10%		<u>- 20.28</u>			[=]		108.00 X	
		182.48			52.64		1.39 =	
Tax 5%			108		108.		150.12 +	
Impuesto 5%,Taxe de 5%		<u>+ 9.12</u>			108.00			
Net, Neto, Net		191.60			1.39		202.76 T	
					[=]			
					150.12			
					[T]		202.76 X	
					202.76		202.76 X	
					[X]		10.00 %	
			10		10.		20.28 +	
					[%±]			
					20.28			
					[-]		182.48 -%	
					182.48		182.48 -%	
			5		5.		182.48 X	
					[%±]		5.00 %	
					9.12		9.12 +	
					[+]			
					191.60		191.60+%	
					[C]		0. C	
					0.			

28. Payroll – Nomina – Paye

	<u>Rounding</u> 5/4	<u>Print</u> P	<u>Decimal</u> 2	<u>F-Cal</u> .	<u>Σ</u> Σ	<u>GT</u> .
<u>Problem:</u>	<u>Given</u>		<u>Find</u>			
	\$ 5.75 Hourly Rate		Regular Pay	\$218.50		
	38 Hours Worked		Total Deductions	\$ 44.12		
	7.15% FICA		Net Pay	\$174.38		
	\$23.75 Withholding					
	\$ 4.75 Insurance					
 <u>Problema:</u>	<u>Determinado</u>		<u>Buscar</u>			
	\$ 5.75 Sueldo por horas		Paga Regular	\$218.50		
	38 Horas trabajadas		Deducciones totales	\$ 44.12		
	7.15% FICA(contribucion)		Pago Neto	\$174.38		
	\$23.75 Retencion					
	\$ 4.75 Seguro					
 <u>Problème:</u>	<u>Donne</u>		<u>Trouver</u>			
	\$ 5.75 Taxu horaire		Paye Reguliere	\$218.50		
	38 Heures de travail		Total Deductions	\$ 44.12		
	7.15% Assurance Sociale		Salaire net	\$174.38		
	\$23.75 Retenue					
	\$ 4.75 Assurance					

<u>Problem</u>	<u>Enter</u>	<u>Display</u>	<u>Paper</u>
<u>Problema</u>	<u>Apriete</u>	<u>Desplegado</u>	<u>Papel</u>
<u>Problème</u>	<u>Appuyer Sur</u>	<u>Afficher</u>	<u>Bande</u>
See Above	5.75	5.75	
Miraar arriba	[X]	5.75	5.75 X
Voir ci-dessus	38	38.	38.00 =
	[M+]	I 218.50	218.50 M+
	[X]	I 218.50	
	7.15	I 7.15	218.50 X
	[%±]	I 15.62	7.15 %
	23.75	I 23.75	15.62 +
	[+]	I 39.37	
	4.75	I 4.75	23.75 +
	[+]	I 44.12	4.75 +
	[T]	I 44.12	44.12 T
	[M-]	I 44.12	
	[MT]	174.38	44.12 M-
			174.38 MT

29. Memory Calculation
Cálculo De la Memoria
Calcul De Mémoire

Rounding Print Decimal F-Cal Σ GT
 5/4 P F . . .

Problem Problema Problème	Enter Apriete Appuyer Sur	Display Desplegado Afficher	Paper Papel Bande
100 + 200 =?	[C/CE]	0.	
900 - 500 = ?	100 [+]	100.	0. C
20 x 7 = ?	200 [+]	300.	100. +
<u>12 x 5 = ?</u>	[T]	300.	200. +
Total ?	[M+]	300.	300. T
	900 [+]	900.	
	500 [-]	400.	300. M+
	[T]	400.	900. +
	[M+]	400.	500. -
	20 [X]	20.	400. T
	7 [=]	140.	
	[M+]	140.	400. M+
	12 [X]	12.	20. X
	5 [M+]	60.	7. =
	[MS]	900.	140. *
	[MT]	900.	
			140. M+
			12. X
			5. =
			60. M+
			900. MS
			900. MT

30. Using IIT Key and Units Price Mode for Model 1570-6
Uso de la tecla IIT y modo de precio de articulos para el modelo
1570-6
Utilisation de la touche IIT. Modèle 1570-6

Rounding Print Decimal F-Cal Σ GT
5/4 P + . . .

Problem
Problema
Problème

Enter
Apriete
Appuyer Sur

Display
Desplegado
Afficher

Paper
Papel
Bande

456 - 123 + 2 X 3 =

	[IIT]	0.
	[T]	0.00
456		456.
	[IIT]	456.
	[+]	II 4.56
123		II 123.
	[IIT]	II 123.
	[-]	II 1.23
	[IIT]	II 1.23
	[#/S]	II 3.33
2		II 2.
	[X]	II 2.00
3		II 3.
	[=]	II 0.06
	[IIT]	II 0.06
	[+]	II 0.06
	[IIT]	II 0.06
	[T]	3.39

0.00	^M _{II} T
4.56	^M _{II} +
1.23	^M _{II} -
3.33	^M _{II} S
2.00	X
0.03	=
0.06	*
0.06	^M _{II} +
3.39	^M _{II} T

31. Time Calculation- The "Time/Date Cal" key is used to enter and exit the time and date calculation mode.

Cálculo del tiempo- La tecla "Time/Date Cal" se utiliza para entrar y salir del modo del calculo del tiempo.

Calcul de temps- La touche "Time/Date Cal" est utilisée pour activer et désactiver le mode de calcul de temps.

Rounding Print Decimal F-Cal Σ GT
5/4 P 2 . . .

The following time calculation example shows addition and subtraction of hours and minutes.

El ejemplo siguiente son calculaciones de tiempo que demuestran adición y sustracción de horas y minutos.

L'exemple suivant démontre la procédure à suivre pour additionner et soustraire les heures et les minutes.

Problem Problema Problème	Enter Apriete Appuyer Sur	Display Desplegado Afficher	Paper Papel Bande
12 H 34 M	[TIME CAL]	00-00	
+ 5 H 12 M	1234 [+]	12-34	00 00 C
?	0512 [+]	17-46	12 34 +
	[#/S]	17-46	05 12 +
- 1 H 20 M	0120 [-]	16-26	17 46 S
?	[#/S]	16-26	01 20 -
	[T]	16-26	16 26 S
	[TIME CAL]	0.	16 26 T
			0. C

Note: When multiplying and dividing hours and minutes, the minutes are automatically converted to a decimal (a percentage of 60 minutes). After each function, depressing the plus (+) key converts the answer back to hours and minutes.

To exit time calculation functions, depress the "Time/Date Cal" button again.

Nota: Al multiplicar y dividir horas y minutos, los minutos automáticamente se convierten a un decimal (un porcentaje de 60 minutos). Después de cada función, presionando la tecla de sumar (+) convierte la respuesta de Nuevo a horas y minutos.

Para salir los funciones del tiempo, presione la tecla "Time/Date Cal" de nuevo.

Note: Lors des calculs de multiplication et de division des heures et des minutes, les minutes sont automatiquement converties en décimales (un pourcentage de 60 minutes). Après chaque opération, vous n'aurez qu'à presser la touche plus (+) pour reconverter le résultat en heures et minutes.

Pour désactiver le mode de calcul de temps, pressez la touche "Time/Date Cal" de nouveau.

The following time calculation example shows multiplication and division of hours and minutes.

El ejemplo siguiente son calculaciones de tiempo que demuestran multiplicación y división de horas y minutos.

L'exemple suivant démontre la procédure à suivre pour multiplier et diviser les heures et les minutes.

Problem Problema Problème	Enter Apriete Appuyer Sur	Display Desplegado Afficher	Paper
5 H 23 M x 4 = ?	[TIME CAL]	00-00	00 00 C
11 H 54 M ÷ 8 = ?	0523 [X]	5.383333333333	5.383333333333 X
Total ?	4 [=]	21.53	4.00 =
	[+]	21-32	21.53 *
	1154 [+]	11.90	21 32 +
	8 [=]	1.49	11.90 ÷
	[+]	23-01	8.00 =
	[T]	23-01	1.49 *
	[TIME CAL]	0.	01 29 +
			23 01 T
			0. C

Note: When multiplying and dividing hours and minutes, the minutes are automatically converted to a decimal (a percentage of 60 minutes). After each function, depressing the plus (+) key converts the answer back to hours and minutes.

To exit time calculation functions, depress the “Time/Date Cal” button again.

Nota: Al multiplicar y dividir horas y minutos, los minutos automáticamente se convierten a un decimal (un porcentaje de 60 minutos). Después de cada función, presionando la tecla de sumar (+) convierte la respuesta de Nuevo a horas y minutos.

Para salir los funciones del tiempo, presione la tecla “Time/Date Cal” de nuevo.

Note: Lors des calculs de multiplication et de division des heures et des minutes, les minutes sont automatiquement converties en décimales (un pourcentage de 60 minutes). Après chaque opération, vous n'aurez qu'à presser la touche plus (+) pour reconverter le résultat en heures et minutes.

Pour désactiver le mode de calcul de temps, pressez la touche "Time/Date Cal" de nouveau.

32. **Date Calculation** – The TIME/DATE CAL key is used to enter and exit the time and date calculation mode.

$$\frac{\text{Rounding}}{5/4} \quad \frac{\text{Print}}{P} \quad \frac{\text{Decimal}}{2} \quad \frac{\text{F-Cal}}{\cdot} \quad \frac{\Sigma}{\cdot} \quad \frac{GT}{\cdot}$$

To activate date function depress the [TIME/DATE CAL] key twice.

In date mode: [MT] key changed to [Start Date] key
 [M-] key changed to [End Date] key
 [M+] key changed to [# of Days] key
 [MS] key changed to [Compute] key

Example: Compute the number of days between 25-May-2005 and 30-May-2005

Problem
Problema
Problème

Enter
Apriete
Appuver Sur

Display
Desplegado
Afficher

Paper
Paapel
Bande

[TIME/DATE CAL]	[TIME/DATE CAL]	00-00-0000
05252005	[START DATE]	05-25-2005
05302005	[END DATE]	05-30-2005
	[COMPUTE]	5.

00 00 C
00 00 0000 C
05 25 2005
05 30 2005
.....
5.
.....
05 25 2005
5.
.....
05 30 2005

Example: Determine the date 4 days hence 25-May-2005

05252005	[START DATE]	05-25-2005
	[# OF DAYS]	0
5	[COMPUTE]	05-30-2005

05 25 2005
5.
.....
05 30 2005
5-
.....
05 25 2005
.....
0. C

Example: Determine the date 4 days prior 30-May-2005

05252005	[START DATE]	05-25-2005
	[# OF DAYS]	0
5	[+/-]	-5
	[COMPUTE]	05-25-2005
	[TIME/DATE CAL]	0

Note: Date range 1-1-1900 → 12-31-2999

33. Financial Calculation
Cálculo Financiero
Calcul Financier

Rounding Print Decimal F-Cal Loan/FV GT
5/4 P 2 F-Cal Loan • .

Problem Problema Problème		Enter Apriete Appuyer Sur		Display Desplegado Afficher	Paper Papel Bande
Loan Amount, Cantidad Del Préstamo, Quantité De Prêt	\$100,000	100000	[Amount]	100,000.00	100,000.00 Δ
Interest, Interés, Intérêt	6.5%	6.5	[Interest]	6.50	6.50 %
Months, Meses, Mois	180	180	[Months]	180.00	180.00 M
Payment, Pago, Paiement	?		[Payment]	871.11 871.11 C*
Payment changed to 600 months	?	600	[Payment]	600.00	600.00 C
Pago cambiante a 600 meses	?		[Months]	432.00 432.00 M*
Paiement changé en 600 mois	?				

Note: Cost-Sell-Margin is disabled when in this mode.

Nota: Costo-Venta-Margen es deshabilitado cuando esta en este modo.

Note: Lors de ce mode, les touches coûtant-vendant-marge sont désactivées.

34. Amortization
Amortissement
Amortización

Rounding Print Decimal F-Cal Loan/FV GT
 5/4 P 2 F-Cal Loan • .

Problem **Enter** **Display** **Paper**
Problema **Apriete** **Desplegado** **Papel**
Problème **Appuyer Sur** **Afficher** **Bande**

Loan Amount \$100,000	100000[Amount]	100,000.00
Payment \$871.11	871.11 [Payment]	871.11
Months 180	180 [Months]	180.
Interest ?	[Interest]	6.50

100,000.00 Δ
871.11 C
180. M
.....
6.50%
.....

Problem **Enter** **Display** **Paper**
Problema **Apriete** **Desplegado** **Papel**
Problème **Appuyer Sur** **Afficher** **Bande**

[Amortization]

#1	871.11 C
	329.44 Δ-
	541.67 G%
	541.67 G*
	99,670.56 Δ*

#2	871.11 C
	331.23 Δ-
	539.88 G%
	1,081.55 G*
	99,339.33 Δ*

#180	871.1 C
	866.42 Δ-
	4.69 G%
	56,799.00 G*
	0.80 Δ*

(continue print until 180 months)

(months)

(Payment Amount)
 (Principle Applied)
 (Interest Paid)
 (Accumulated Interest Paid)
 (New Balance)

To stop the printing of the Amortization Schedule, press [C/CE] key.
 User can select a month or range of months for printing an amortization schedule.
 For example, if you wish to print the schedule for month 3, enter 3 then the press Amortization key.

Para dejar de imprimir en la funcion de amortización debe oprimir la tecla [C/CE]
 El usuario puede seleccionar una mes o un par de meses para imprimir un horario bajo la funcion de amortización
 Por ejemplo, si decea imprimir un horario para el mes numero 3 haga lo siguiente : entre 3 y despues oprima la tecla de amortización.

Pour interrompre l'impression du tableau d'amortissement, appuyez sur la touche [C/CE].
 L'utilisateur peut choisir un mois ou une portée de mois pour imprimer un tableau d'amortissement.
 Par exemple, si vous voulez imprimer le calendrier pour le mois 3, entrez 3, puis appuyez sur la touche Amortissement

Problem
Problema
Problème

Enter
Apriete
Appuyer Sur
 3 [Amortization]

Display
Desplegado
Afficher
 0.

Paper
Papel
Bande

#3
871.11 C
333.02 Δ-
538.09 G%
1,619.64 G*
99,006.31 Δ*
.....

Example : If you wish to print the schedule between months 12 and 24, enter 12.24 the press the [Amortization] key.

Problem
Problema
Problème

Enter
Apriete
Appuyer Sur
 12.24 [amortization]

Display
Desplegado
Afficher
 0.

Paper
Papel
Bande

#12
871.11 C
349.61 Δ-
521.50 G%
6,380.07 G*
95,926.75 Δ*
.....
#13
871.11 C
351.51 Δ-
519.60 G%
6,899.67G*
95,575.24 Δ*
.....
(Print schedule for months 12 through and including 24)

35. Future Value
Valor Futuro
Valeur capitalisée

	<u>Rounding</u> 5/4	<u>Print</u> P	<u>Decimal</u> 2	<u>F-Cal</u> F-Cal	<u>Loan/FV</u> FV	<u>GT</u> .
Problem Problema Problème			Enter Apriete Appuyer Sur	Display Desplegado Afficher		Paper Papel Bande
Deposit Amount	\$10,000.00		10000 [Amount]	10,000.00		10,000.00 Δ
Payment	\$100.00		100 [Payment]	100.00		100.00 C
Months	48		48 [Months]	48.		48. M
Interest	3.5%		3.5 [Interest]	3.50		3.5%
Future Value	?		[FV]	16,644.60	 16,644.60 Δ+
FV Changed to	\$100000.00		100000 [FV]	100,000.00		100,000.00 Δ+
Payment	?		[Payment]	1,720.37	 1,720.37 C*

NOTE : All financial items will be clear once user changes financial mode switch or by pressing the [C/CE] key.

NOTA : Todas las calculaciones financieras seran borradas si usted se sale de la funcion financiera o si pregiona la teclas [C/CE]

REMARQUE : Toutes les entrées financières seront effacées lorsque l'utilisateur change l'interrupteur du mode financier ou appuie sur la touche [C/CE].

36. Setting the DATE Ajuste de la FECHA Réglage de la DATE

Set Slide Switches as Example Below:

Ajuste los selectores de modo como el ejemplo abajo:

Placer les commutateurs comme ci-après

Rounding Print Decimal F-Cal Σ GT
5/4 P 2 . . .

EXAMPLE: Set DATE to September 14, 2005 (09-14-05)

EJEMPLO: Ajuste FECHA a 14 Septiembre, 2005 (14-09-05)

EXEMPLE: Régler la DATE au 14, septembre 2005 (14-09-05)

English:

Step #	Enter	Depress This Key	Your Display Will Show	Tape Will Read
1.		Clear Key (C) or (CE)	0.	0.C
2.		TIME/DATE Key and hold until display flashes	Flashing Numbers in This Format - MM-DD-YYYY	
3.	09		9	
4.	14		914	
5.	05		91405	
6.		Tap TIME/DATE Key	09-14-2005	
7.		#/S Key	09-14-2005	#9.14.2005

1. Depress the **C** or **C/CE** key. Your display will show 0. and the tape will read 0.C.
2. Depress the **TIME/DATE** key and hold until the display is flashing.
3. Enter the month, in our example, 09. Your display will show 9.
4. Enter the day, in our example, 14. Your display will show 914.
5. Enter the year, in our example 2005, as 05. Your display will show 91405.
6. Tap the **TIME/DATE** key to set the DATE. Your display will now show 09-14-2005.
7. To PRINT the DATE, depress the (**#/S**) key, your tape will show # 9.14.2005.

Spanish:

1. Presione la tecla **C** o **C/CE**. El desplegado va a demostrar 0. y el papel va a leer 0.c.
2. Presione y aguante la tecla **TIME/DATE** hasta que empiece ha parpadear.
3. Entre el mes, en nuestro ejemplo, 09. Su desplegado va demostrar 9.
4. Entre el día, en nuestro ejemplo, 14. Su desplegado va demostrar 914.
5. Entre el año, en nuestro ejemplo 2005, como 05. Su desplegado va demostrar 91405.
6. Toque la tecla **TIME/DATE** para ajustar la FECHA. Su desplegado ahora va demostrar 09-14-2005.
7. Para imprimir la FECHA, presione la tecla (**#S**), su papel va demostrar # 9.14.2005.

French :

1. Appuyez sur la touche **C** ou **C/CE**. 0. sera affiché et 0.C. sera imprimé sur le ruban de papier.
2. Appuyez sur la touche **TIME/DATE** et la tenir enfoncée jusqu'à ce que l'affichage clignote.
3. Entrez le chiffre du mois: dans notre exemple 09. 9 sera affiché.
4. Entrez le chiffre du jour: dans notre exemple 14. 914 sera affiché.
5. Entrez les 2 derniers chiffres de l'année: dans notre exemple 03 pour 2005. 91405 sera affiché.
6. Appuyez sur la touche **TIME/DATE** pour sauvegarder la DATE. 09-14-2005 sera maintenant affiché.
7. Pour imprimer la DATE sur le ruban de papier, appuyez sur la touche (**#/S**). # 9.14.2005 sera imprimé sur le papier.

- NOTE: The only key to enter the Date/Time display mode is the TIME/DATE key. The only key to exit the Time/Date display mode is the C or CE key and the C/CE key on the Model 1570-6.
- NOTA: La única tecla para entrar en el modo visualización de Fecha/Hora es la tecla TIME/DATE (HORA). La única tecla para salir del modo visualización de Fecha/Hora es la tecla C o CE y la tecla C/CE en el Modelo 1570-6.
- NOTE: La seule touché servant à entrer le mode d'affichage Date/Time (Date/Heure) est la touché TIME/DATE (HEURE). La seule touché servant à quitter le mode d'affichage Time/Date (Heure/Date) est la touché C ou CE et la touché C/CE sur le Modele 1570-6.

37. Setting the TIME Ajuste del HORA Réglage de la HEURE

Set Slide Switches as Example Below:

Ajuste los selectores de modo como el ejemplo abajo:

Placer les commutateurs comme ci-après

Rounding Print Decimal F-Cal Σ GT
 5/4 P 2 . . .

EXAMPLE: Set TIME to 4:37 PM

EJEMPLO: Ajuste HORA a 4:37 DEPUSE DEL MEDIODIA

EXEMPLE: Réglage HEURE a 4:37 APRES-MIDI

Step #	Enter	Depress This Key	Your Display Will Show	Tape Will Read
1.		Clear Key (C) or (CE)	0.	0.C
2.		TIME/DATE Key and hold until display flashes	Flashing Numbers in This Format - MM-DD-YYYY	
3.		Tap TIME/DATE key to switch to Time Mode	Flashing Numbers in This Format - HH-MM-SS	
4.	16		16	
5.	37		1637	
6.		Tap TIME/DATE Key	P 04-37-00	
7.		#/S Key	P 04-37-00	#•04•37

English:

1. Depress the **C** or **C/CE** key. Your display will show 0. and the tape will read 0.C.
2. Depress the **TIME/DATE** key and hold until the display is flashing.
3. Tap the **TIME/DATE** key to go to Time Mode.
4. Enter the hour, in our example 16 in military time. Your display will show 16.
5. Enter the minutes, in our example 37. Your display will show 1637.
6. Tap the **TIME/DATE** key to set the TIME. Your display will now show P 04-37-00 and the seconds will begin counting.
7. To **PRINT** the TIME, depress the **(#/S)** key, your tape will show #•04•37.

Spanish:

1. Presione la tecla **C** or **C/CE**. El desplegado va a demostrar 0. y el papel va a leer 0.c.
2. Presione y aguante la tecla **TIME/DATE** hasta que empiece ha parpadear.
3. Toque la tecla **TIME** para llegar al modo de la hora
4. Entre la hora, en nuestro ejemplo 16. Su desplegado va demostrar 16.
5. Entre los minutos, en nuestro ejemplo 37. Su desplegado va demostrar 1637
6. Toque la tecla **TIME/DATE** para ajustar la HORA. Su desplegado ahora va demostrar P 04-37-00 y después va a comenzar contando.
7. **Para imprimir** la hora, presione la tecla **(#/S)**, su papel va demostrar #•04•37.

French:

1. Appuyez sur la touche **C** ou **C/CE**. 0. sera affiché et 0.C sera imprimé sur le ruban de papier.
2. Appuyez sur la touche **TIME/DATE** et la tenir enfoncée jusqu'à ce que l'affichage clignote.
3. Appuyez sur la touche **TIME/DATE** pour entrer dans mode de programmation de l'heure.
4. Entrez le chiffre des heures: dans notre exemple 16. 16 sera affiché.
5. Entrez le chiffre des minutes: dans notre exemple 37. 437 sera affiché.
6. Appuyez sur la touche **TIME/DATE** pour sauvegarder l'HEURE. P 04-37-00 sera maintenant affiché et les secondes commenceront à s'ajouter.
7. **Pour imprimer** l'HEURE sur le ruban de papier, appuyez sur la touche **(#/S)**. #•04•37 sera imprimé sur le papier.

NOTE: On the **PRINT** on the paper tape, the dot in front (#•07•05) means PM, there will be no dot printed for AM.

El punto en frente quiere decir PM, no habrá un punto mostrado para AM.

Le point en face de 07 signifie PM (après-midi). L'absence d'un point signifie AM (matin).



WARRANTY

Your new VICTOR electronic calculator is guaranteed to the original purchaser for three (3) years for all parts and labor, providing repair work is performed at an authorized VICTOR Regional Service Center and the unit is sent prepaid. Warranty repair requires a copy of the original purchase invoice or receipt to be packed with the machine. The address and phone number of our National Service Depot is below.

Any warranty, statutory or otherwise, does not include service and/or replacement or repair of parts when damage or defect is a result of accident, abuse, or the elements.

GARANTIE

Votre nouvelle calculatrice électronique VICTOR est garantie au premier acheteur pendant une période de trois ans pour toutes les pièces et la main d'œuvre, à condition que les réparations soient effectuées dans un Centre de Service Régional VICTOR autorisé et que l'appareil soit envoyé par courrier affranchi. Pour les Centres de Service situés à l'extérieur des États-Unis, veuillez consulter votre distributeur de fournitures de bureau local ou le site Web de VICTOR. Pour qu'une réparation soit couverte par la garantie, il faut joindre la facture ou le reçu d'achat avec l'appareil.

Toute garantie, légale ou autre, n'inclut pas l'entretien et/ou le remplacement ou la réparation de pièces lorsque le dommage ou la défectuosité est dû à un accident, à un mauvais usage ou aux éléments.

LA GARANTÍA

Su nueva calculadora electrónica de VICTOR se garantiza a el comprador original durante tres años para todas las partes y labora, mientras proporcionando el trabajo de la reparación ha realizado en un Centro Regional de Reparaciones autorizado por VICTOR y la unidad se envía por el correo pagado por adelantado. Para los Centros de Servicio fuera del EE.UU por favor consultan su suministro de la oficina local distribuidor o VICTOR Web Site. La reparación de la garantía requiere una copia de la factura de la compra original o recibo ser condensado con la máquina.

Cualquier garantía, estatutario o por otra parte, no incluya el servicio y o reemplazo o reparación de partes cuando daño o defecto es un resultado de accidente, abuse, o los elementos.

Victor Technology
780 West Belden Avenue
Addison, IL 60101 USA
Telephone: 800-628-2420
Fax: 630-268-8450
<http://www.victortech.com>



REGISTER ON LINE AT www.victortech.com

Or

FILL OUT THIS FORM AND MAIL TO THE ADDRESS ON BACK

Date Purchased: _____ Model No. _____ Serial No. _____

User's Name: _____

Company Name (if applicable): _____

Address: _____

City: _____ State: _____ Zip: _____

Purchased From: _____

Address: _____

City: _____ State: _____ Zip: _____



VICTOR EXTENDED PROTECTION PROGRAM

ONLY \$25.00

Act now and extend your VICTOR warranty for another full year!

Covers all parts and labor.

Name: _____ Date: _____

Address: _____

City: _____ State: _____ Zip: _____

To receive repair coverage on your VICTOR calculator for one full year from expiration of VICTOR'S 3 year warranty, enclose this form and proof of purchase (invoice) showing your name, complete address, model and serial number along with your check or money order for \$25.00 payable to: Victor Technology, Attn: Extended Warranty Dept., 780 West Belden, Addison, IL 60101.

VICTOR will acknowledge receipt, send you an authorized coverage agreement, and provide the address of the authorized VICTOR Regional Service Center nearest you.

Repair necessitated by accident or abuse is excluded.

If repairs are needed during the coverage period, ship your VICTOR calculator to the nearest authorized VICTOR Regional Service Center, freight PREPAID. It will be promptly repaired and returned to you freight prepaid.

Retain packing box and materials. Offer void 30 days after Purchase.

Place
Stamp
Here

Victor Technology
780 West Belden Avenue
Addison, IL 60101

Technical Specifications Spécifications techniques Caractéristiques Techniques

Type: Desktop Adding Machine/Calculator, Electronic Print /VFD
Tipo: Maquina Sumadora / Calculadora de Escritorio, Impresión Electrónica / VFD
Type: Calculatrice de bureau à impression électronique

Basic Operations: Addition/subtraction and multiplication/division
Operaciones Básicas: Adición / sustracción y Multiplicación / división
Opérations de base: Addition/soustraction et multiplication/division

Capacity: Input and result 14 Digits for 1570-6
Input and result 12 digits for 1560-6
Input and result 10 digits for 1530-6

Capacidad: Entrada y Resultado de 14 dígitos para el modelo 1570-6
Entrada y Resultado de 12 dígitos para modelos 1560-6
Entrada y Resultado de 10 dígitos para modelos 1530-6

Capacité: Entrée et résultat de 14 chiffres pour la 1570-6
Entrée et résultat de 12 chiffres pour les 1560-6
Entrée et résultat de 10 chiffres pour les 1530-6

Decimal System: Add Mode (+), Floating (F), Fixed (0,1,2,3,4,6)
Sistema Decimal: Modo de agregar (+), Flotable (F), Fijado (0,1,2,3,4,6)
Système décimal: Mode d'addition (+), flottante (F), fixe (0, 1, 2, 3, 4, 6)

Functions: 4 rules, successive calculation, memory calculation, grand total calculation, constant calculations, time calculation, financial calculation, tax calculation, cost, sell and margin calculation.

Funciones: 4 reglas, calculo sucesivo, calculo de la memoria, calculo del gran total, cálculos constantes, calculo del tiempo, calculo financiero, calculo del impuesto, calculo de costo, venta, y margen.

Fonctions: 4 règles, calcul en chaîne, calcul de la mémoire, grand total, calculs avec constantes, calcul de temps, calculs financiers, calcul de la taxe, coûtant, vendant et marge.

Printer: Character wheel selection type.
Impresora: Tipo de la selección de la rueda de carácter
Imprimante: Sélection de la roulette de caractères.

Power Consumption: 11 Watts
Consumo de Energía: 11 Vatios
Consommation d'énergie: 11 watts

Ink: **Victor** Twin Spool Ribbon 7010, Cartridge, 7011
Tinta: Rodillo Doble de Cinta 7010, Cartucho de Cinta 7011
Rouleau encreur: Double bobine Victor #7010, Cartouche Victor 7011

Paper Width: 2-1/4", 57.5 ± 0.5mm
Anchura de Papel: 57.5 = 0.5mm
Largeur de papier: 2 ¼" ou 57.5mm

Display: 14 digit VFD Display for 1570-6
 12 Digit VFD display for 1560-6
 10 Digit VFD display for 1530-6

Pantalla: Exhibición VFD de 14 dígitos para el modelo 1570-6
 Exhibición VFD de 12 dígitos para modelos 1560-6
 Exhibición VFD de 10 dígitos para modelos 1530-6

Écran: Affichage VFD de 14 chiffres sur le modèle 1570-6
 Affichage VFD de 12 chiffres sur les modèles 1560-6
 Affichage VFD de 10 chiffres sur les modèles 1530-6

Operating Temp: 32° ~ 104° F, 0° ~ 40° C
Temp de Funcionamiento: 0C – 40C
Température d'utilisation: 0°C - 40°C

Dimensions: 12-1/2" L x 8-1/2" W x 2-5/8" H
Dimensiones: 31.75 cm L x 21.59 cm A x 6.35 cm A
Dimensions: 31.75cm L x 21.59cm l x 6.35 cm H

Weight: 4.1 lbs, 1.86kg
Peso: 1.86kg
Poids: 1.86kg

This information is furnished to comply with FCC requirements

This equipment generates and uses radio frequency energy and if not installed and used properly, that is, in accordance with the manufacturer's instructions, may cause interference to radio and television reception. It has been type tested and found to comply with the limits for a Class B computing device in accordance with the specifications in Subpart j of Part 15 of FCC Rules, which are designed to provide reasonable protection against such interference in a residential installation. However, there is not guarantee that interference will not occur in a particular installation. If this equipment does cause interference to radio or television reception, which can be determined by turning the equipment off and on, the user is encouraged to try to correct the interference by one or more of the following measures:

- Reorient the receiving antenna.
- Relocate the computing device with respect to the receiver.
- Move the computing device away from the receiver.
- Plug the computing device into a different outlet so that the computing device and receiver are on different branch circuits.

If necessary, the user should consult the dealer or experienced radio/television technician for additional suggestions. The user may find the folwing booklet prepared by the Federal Communications Commission helpful:

How to Identify and Resolve Radio-TV Interference Problems

This booklet is available from the U.S. Government Printing office, Washington, DC 20402, Stock No. 004-000-00345-4.

To assure future optimum performance use genuine VICTOR replacement ribbons. Contact you local VICTOR dealer or call our Customer Service Department at 800-628-2420 to place an order.

**Corporate Office
And
National Service Office
VICTOR TECHNOLOGY
780 W. Belden Avenue
Addison, IL 60101
Phone: 630-268-8400
Fax: 630-268-8450
www.victortech.com**