

1

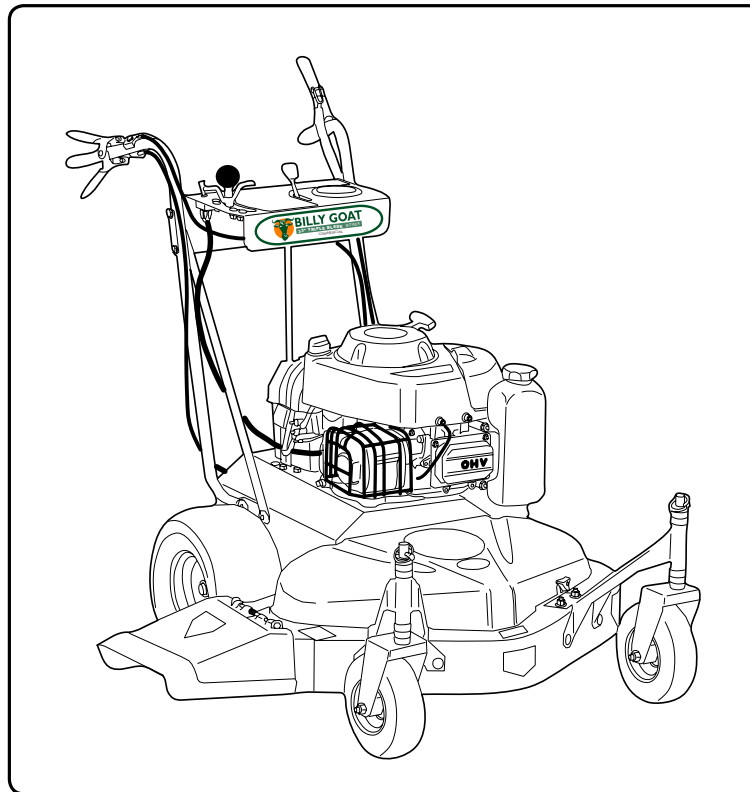

*Thank You for Selecting
The Powerful Self-Propelled Billy Goat Mower*

Operator Owner's Manual

FM3301IN & FM3301INE

Patent Number: D494985

2 **Accessories**

Mulching Kit
P/N 520144
Reduces lawn clippings to fine nutrient-rich particles that filter down to the soil.

Grass Catcher Kit
P/N 520142
Easily convert your mower to bag grass and leaves.

Transaxle Guard Kit
P/N 520155
To protect the transaxle from accidental contact from concrete curbs or other hazards.

3 **Specifications**

	FM3301IN	FM3301INE
Engine: HP	13.0 HP (9.7 kW)	13.0 HP (9.7 kW)
Engine: Type	B&S INTEK OHV	B&S INTEK OHV ELECTRIC START
Engine: Fuel cap.	3.0 qt. (2.8 L)	3.0 qt. (2.8 L)
Engine: Oil Cap.	1.5 qt. (1.4 L)	1.5 qt. (1.4 L)
Weight: Unit	267 # (121 Kg)	277 # (126 Kg)
Weight: Shipping	343# (156Kq)	353# (160Kq)
UNIT SIZE:	OVERALL LENGTH - 57" (1.44 m) OVERALL WIDTH - 43" (1.09 m) OVERALL HEIGHT - 47" (1.19 m)	

5



IN THE INTEREST OF SAFETY

BEFORE STARTING ENGINE, READ AND UNDERSTAND THE "ENTIRE OPERATOR'S MANUAL & ENGINE MANUAL."

THIS SYMBOL MEANS WARNING OR CAUTION. DEATH, PERSONAL INJURY AND/OR PROPERTY DAMAGE MAY OCCUR UNLESS INSTRUCTIONS ARE FOLLOWED CAREFULLY.



WARNING: The Engine Exhaust from this product contains chemicals known to the State of California to cause cancer, birth defects or other reproductive harm.

WARNING: DO NOT

1. **DO NOT** run engine in an enclosed area. Exhaust gases contain carbon monoxide, an odorless and deadly poison.

2. **DO NOT** place hands or feet near moving or rotating parts.

3. **DO NOT** store, spill or use gasoline near an open flame, or devices such as a stove, furnace, or water heater which use a pilot light or devices which can create a spark.

4. **DO NOT** refuel indoors where area is not well ventilated. Outdoor refueling is recommended.

5. **DO NOT** fill fuel tank while engine is running. Allow engine to cool for 2 minutes before refueling. Store fuel in approved safety containers.

6. **DO NOT** remove fuel tank cap while engine is running.

7. **DO NOT** operate engine when smell of gasoline is present or other explosive conditions exist.

8. **DO NOT** operate engine if gasoline is spilled. Move machine away from the spill and avoid creating any ignition until the gasoline has evaporated.

9. **DO NOT** transport unit with fuel in tank.

10. **DO NOT** smoke when filling fuel tank.

11. **DO NOT** choke carburetor to stop engine. Whenever possible, gradually reduce engine speed before stopping.

12. **DO NOT** run engine at excessive speeds. This may result in injury & /or damage to unit.

13. **DO NOT** tamper with governor springs, governor links or other parts which may change the governed engine speed.

14. **DO NOT** tamper with the engine speed selected by the engine manufacturer.

15. **DO NOT** check for spark with spark plug or spark plug wire removed. Use an approved tester.

16. **DO NOT** crank engine with spark plug removed. If engine is flooded, place throttle in "FAST" position and crank until engine starts.

17. **DO NOT** strike flywheel with a hard object or metal tool as this may cause flywheel to shatter in operation. Use proper tools to service engine.

18. **DO NOT** operate engine without a muffler. Inspect periodically and replace, if necessary. If engine is equipped with muffler deflector, inspect periodically and replace, if necessary, with correct deflector.

19. **DO NOT** operate engine with an accumulation of grass, leaves, dirt or other combustible material in the muffler area.

20. **DO NOT** use this engine on any forest covered, brush covered, or grass covered unimproved land unless a spark arrester is installed on the muffler. The arrester must be maintained in effective working order by the operator. In the State of California the above is required by law (Section 4442 of the California Public Resources Code). Other states may have similar laws. Federal laws apply on federal lands.

21. **DO NOT** touch hot muffler, cylinder, or fins

because contact may cause burns.

22. **DO NOT** run engine without air cleaner or air cleaner cover.

23. **DO NOT** operate during excessive vibration!

24. **DO NOT** leave machine unattended while in operation.

25. **DO NOT** park machine on a steep grade or slope.

WARNING: DO

1. **ALWAYS DO** remove the wire from the spark plug when servicing the engine or equipment TO PREVENT ACCIDENTAL STARTING.

2. **DO** keep cylinder fins and governor parts free of grass and other debris which can affect engine speed.

3. **DO** pull starter cord slowly until resistance is felt. Then pull cord rapidly to avoid kickback and prevent hand or arm injury.

4. **DO** examine muffler periodically to be sure it is functioning effectively. A worn or leaking muffler should be repaired or replaced as necessary.

5. **DO** use fresh gasoline. Stale fuel can gum carburetor and cause leakage.

6. **DO** check fuel lines and fittings frequently for cracks or leaks. Replace if necessary

7. **Follow** engine manufacturer operating and maintenance instructions.

8. **Inspect** machine and work area before starting unit.

6 TABLE OF CONTENTS

SAFETY INSTRUCTIONS	2
GENERAL SAFETY	3
ASSEMBLY	4
LIT. BAG & CONTROLS	5
LABELS	5 - 6
OPERATION	6 - 9
MAINTENANCE	10 - 14
PARTS DRAWING & LIST	15 - 18
ACCESSORIES	19
TROUBLESHOOTING	20
WARRANTY PROCEDURE	20

7

SOUND

Sound tests conducted were in accordance with 2000/14/EEC and were performed on 9/18/03 under the condition listed.

NOTE: Sound power level listed is the highest value for any model in this manual. Please refer to serial plate on the unit for the sound level for your model.

Sound level of 95 dBA at operator position

GENERAL CONDITION: Sunny

L_{WA}

100 dB

(FM3301IN MODEL)

TEMPERATURE: 75 °F (23.9 °C)

WIND SPEED: 8.1 MPH (13.0 KPH)

WIND DIRECTION: South West

HUMIDITY: 63%

BAROMETRIC PRESSURE: 29.9" Hg (759mm Hg)

8

VIBRATION

VIBRATION LEVEL 1.8 g

Vibration levels at the operators handles were measured in the vertical, lateral, and longitudinal directions using calibrated vibration test equipment. Tests were performed on 10/1/03 under the conditions listed:

GENERAL CONDITION: Sunny

TEMPERATURE: 46 °F (7.8 °C)

WIND SPEED: 7.0 MPH (11.3 kmh)

WIND DIRECTION: South West

HUMIDITY: 66%

BAROMETRIC PRESSURE: 30.4" Hg (772mm Hg)

For your safety and the safety of others, these directions should be followed:



Do not operate this machine without first reading owner's manual and engine manufacturer's manual.



Use of Ear Protection is recommended while operating this machine.



Use of Eye and Breathing protection is recommended when using this machine.

This cutting machine is capable of amputating hands and feet and throwing objects. Failure to observe the following safety instructions could result in serious injury or death.

I. General Operation

1. Read, understand, and follow all instructions on the machine and in the manual(s). Be thoroughly familiar with the controls and the proper use of the mower before starting.
2. Do not put hands or feet near or under rotating parts. Keep clear of the discharge opening at all times.
3. Only allow responsible individuals, who are familiar with the instructions, to operate the mower.
4. Clear the area of objects such as rocks, toys, wire, bones, sticks etc., which could be picked up and thrown by the blade(s).
5. Be sure the area is clear of other people before mowing. Stop mower if anyone enters the area.
6. Do not operate the mower when barefoot or wearing open sandals. Always wear substantial foot wear.
7. Do not pull mower backwards unless absolutely necessary. Look down and behind before and while moving backwards.
8. Do not operate the mower without proper guards, plates, grass catcher or other safety protective devices in place.
9. See manufacturer's instructions for proper operation and installation of accessories. Only use accessories approved by the manufacturer.
10. Stop the blade(s) when crossing gravel drives, walks, or roads.
11. Stop the engine (motor) whenever you leave the equipment, before cleaning the mower or unclogging the chute.
12. Shut the engine (motor) off and wait until the blade comes to complete stop before removing grass catcher.
13. Mow only in daylight or good artificial light.
14. Do not operate the mower while under the influence of alcohol or drugs.
15. Never operate mower in wet grass. Always be sure of your footing; keep a firm hold on the handle and walk; never run.
16. Disengage the self-propelled mechanism or drive clutch on mowers so equipped before starting the engine (motor).
17. If the equipment should start to vibrate abnormally, stop the engine (motor) and check immediately for the cause. Vibration is generally a warning of trouble.
18. Always wear safety goggles or safety glasses with side shields when operating mower.

II. Slope Operation

Slopes are a major factor related to slip and fall accidents which can result in severe injury. All slopes require extra caution. If you feel uneasy on a slope, do not mow it.

DO:

Mow across the face of slopes; never up and down. Exercise extreme caution when changing direction on slopes.

Remove objects such as rocks, tree limbs, etc. Watch for holes, ruts, or bumps. Tall grass can hide obstacles.

DO NOT:

Do not mow near drop-offs, ditches, or embankments. The operator could lose footing or balance.
Do not mow excessively steep slopes.

Do not mow on wet grass. Reduced footing could cause slipping.

III. Children

Tragic accidents can occur if the operator is not alert to the presence of children. Children are often attracted to the mower and the mowing activity. Never assume that children will remain where you last saw them.

1. Keep children out of the mowing area and under the watchful care of a responsible adult.
2. Be alert and turn mower off if children enter the area.
3. Before and while moving backwards, look behind and down for small children.
4. Never allow children to operate the mower.
5. Use extra care when approaching blind corners, shrubs, trees, or other objects that may obscure vision.

IV. Service

1. Use extra care in handling gasoline and other fuels. They are flammable and vapors are explosive.
 - a) Use only an approved container.
 - b) Never remove gas cap or add fuel with the engine running. Allow engine to cool before refueling. Do not smoke.
 - c) Never refuel the machine indoors.
 - d) Never store the machine or fuel container inside where there is an open flame, such as a water heater.
2. Never run an engine inside a closed area.
3. Never make adjustments or repairs with the engine (motor) running. Disconnect the spark plug wire, and keep the wire away from the plug to prevent accidental starting.
4. Keep all nuts and bolts, especially blade attachment bolts, tight and keep equipment in good condition.
5. Never tamper with safety devices. Check their proper operation regularly.
6. Keep mower free of grass, leaves, or other debris build-up. Clean up oil or fuel spillage. Allow mower to cool before storing.
7. Stop and inspect the equipment if you strike an Object. Repair, if necessary, before restarting.
8. Never attempt to make wheel height adjustments while the engine (motor) is running.
9. Always disconnect electric mowers (live operated) before cleaning, repairing, or adjusting.
10. Grass catcher components are subject to wear, damage, and deterioration, which could expose moving parts or allow objects to be thrown. Frequently check components and replace with manufacturer's recommended parts, when necessary."
11. Mower blades are sharp and can cut. Wrap the blade(s) or wear gloves, and use extra caution when servicing them.
12. Do not change the engine governor setting or overspeed the engine.

11 ASSEMBLY



Read all safety and operating instructions before assembling or starting this unit.



PUT OIL IN ENGINE BEFORE STARTING.



DISCONNECT SPARK PLUG WIRE BEFORE ASSEMBLING UNIT.

Your Billy Goat Mower is shipped from the factory in one crate, completely assembled except for the handles and console assembly.

NOTE: All item numbers called out in the assembly, operation, and maintenance sections of this manual can be found on Parts List (pages 15-18).

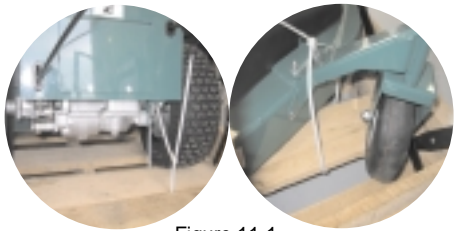

Figure 11-1

1. Cut and remove the nylon retaining straps (see figure 11-1).

2. With the console and handle assembly positioned as shown in Figure 11-3, insert the shift linkage rod (Item 31) into the shift linkage connector (Item 54).

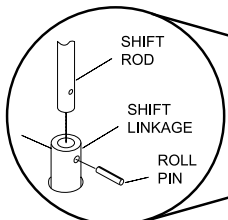

Figure 11-3

3. To assemble the shift rod (item 31) to the shift linkage (item 54), use the roll pin in the parts/literature bag. If you'll notice on the shift linkage, the hole is larger on one side than the other. It will be easier to start the roll pin from the larger side, forcing it through the shift rod and the hole on the other side of the shift linkage, using a hammer or large adjustable pliers.



Figure 11-4

4. Insert one of the handle mounting bolts (Item 102) with split lock washer (Item 6) on top of flat washer (Item 184) through the rear handle mounting hole of the right side handle, and screw it into the rear handle mounting hole on the right side of engine base chassis (Item 61). Repeat this procedure for the left side using the left handle.

5. On each side of the mower, insert one of the handle mounting bolts (Item 102) with split lock washer (Item 6) on top of flat washer (Item 184) through the hole in one end of the handle brace (Item 32), the front handle mounting hole of the handle and screw into the front handle mounting hole in the engine base chassis (Figure 11-5).



Figure 11-5

6. Assemble blade clutch lever (Item 76) to upper handle using pin (Item 97), washer (Item 150, and pal nut (Item 3) (see figure 11-6 and 11-7).

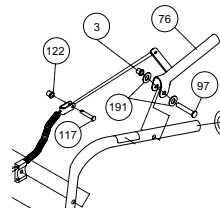

Figure 11-6



Figure 11-7

7. Position control cables and use 2 cable ties on each handle to secure the cables in position. The top cable tie should be 1" below the console and the lower tie should be 12" below the console (see figure 11-8 and 11-9).

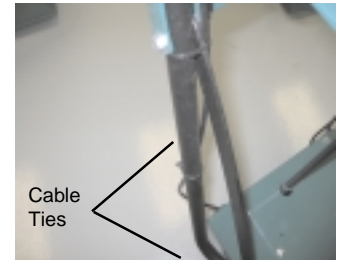

Figure 11-8

8. Check the position of the shift rod guide (Item 69), and if necessary, snap it in place in the shift bracket (Item 78) as shown in Figure 11-8.

9. Put shift lever in NEUTRAL, depress the brake lever (release the brake) and carefully pull the machine back off the pallet.

10. Fill with oil and gas to the proper level and the unit is ready to mow. (a battery will also have to be installed on electric models.)

11. Read the operator's manual.

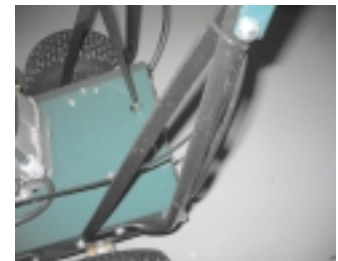



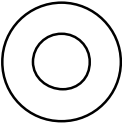
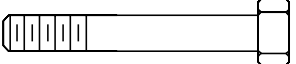

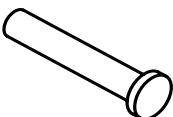

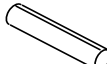

Figure 11-9



Figure 11-10

12 LITERATURE ASSY P/N 520165

Literature Checklist					
Check <input type="checkbox"/>	Owner's Manual 520188	Check <input type="checkbox"/>	Warranty Card 400972	Check <input type="checkbox"/>	Declaration of Conformity 520167

<p>900407 Ty Wrap Qty 4</p> 	<p>8171004 Washer 3/8" FC Qty 4</p> 
<p>8041051 Screwcap 3/8" x 1.25" Qty 4</p> 	<p>8177012 Washer Split Lock 3/8" Qty 4</p> 
<p>520119 Clevis Pin Qty 1</p> 	<p>8171003 Washer 5/16" FC Qty 2</p> 
<p>520156 Roll Pin 1/4" x 1" long Qty 1</p> 	<p>360218 Pal Nut 3/8" Qty 1</p> 

13 CONTROLS

Throttle Control

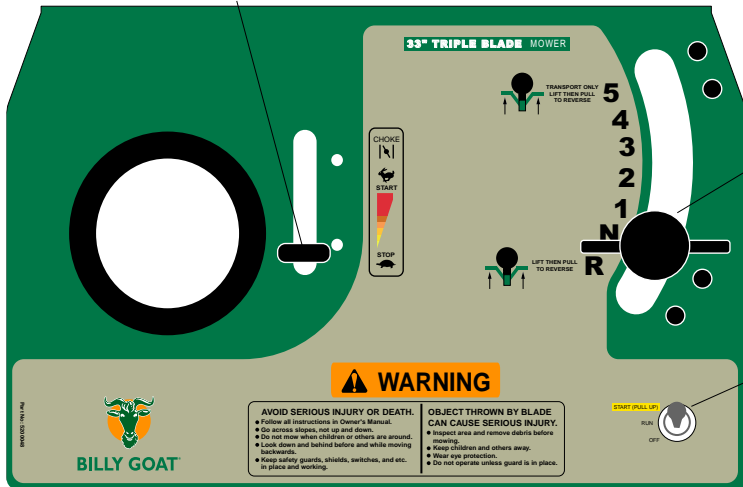

WARNING

AVOID SERIOUS INJURY OR DEATH.

- Follow all instructions in Owner's Manual.
- Do across slopes, not up and down.
- Do not mow when children or others are around.
- Look down and behind before and while moving backwards.
- Keep safety guards, shields, switches, and etc. in place and working.

OBJECT THROWN BY BLADE CAN CAUSE SERIOUS INJURY.

- Inspect area and remove debris before mowing.
- Keep children and others away.
- Wear eye protection.
- Do not operate unless guard is in place.

Speed Control





5th gear (Transporting Speed): Lift up on the lever then push to engage in the 5th gear.

Rev: Lift up on the lever then pull back for reverse.

Electric Start Only

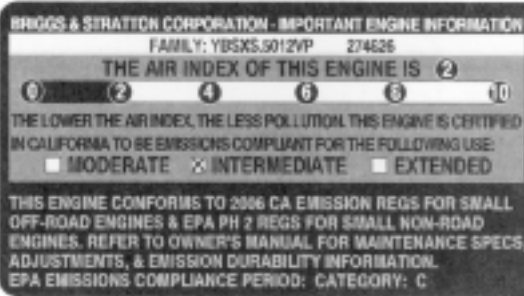
Pull up on the switch then push forward to start the engine.

14 ENGINE LABELS

	<div style="border: 1px solid black; padding: 5px;"> <p style="text-align: center;">WARNING</p> <p> Read and follow Operating Instructions before running engine.</p> <p> Gasoline is flammable. Allow engine to cool at least 2 minutes before fueling.</p> <p> Engines emit carbon monoxide, DO NOT run in enclosed area.</p> </div>
---	---

These labels should be included on your Billy Goat Finish Mower. If any of these labels are damaged, replace them before putting this equipment into operation. Item and part numbers are given to help in ordering replacement labels..



Label Do Not Fill While Engine Is Hot
Item 4 Part No.400268



Label Ear Eye Breathing
Item No. 114 Part No. 890254



Label Warning Guards
Item 119 Part No.900327



Label Design Patent FM
Item 178 Part No.520191



Label Danger Keep Hands and Feet Away
Item 5 Part No.400424



Label Danger Flying Material
Item No. 2 Part No. 810736



Label Warning Mower
Item No. 17 Part No. 510206



Label Read Owner's Manual
Item 52 Part No.890301

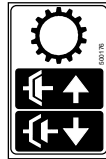

Label Clutch Drive
Item No. 10 Part No. 500176

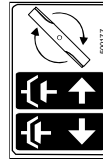

Label Blade Drive
Item No. 11 Part No. 500177



Label Push to Release Brake
Item 95 Part No. 520117

Label FM Electric Console
Item 47 Part No. 520048

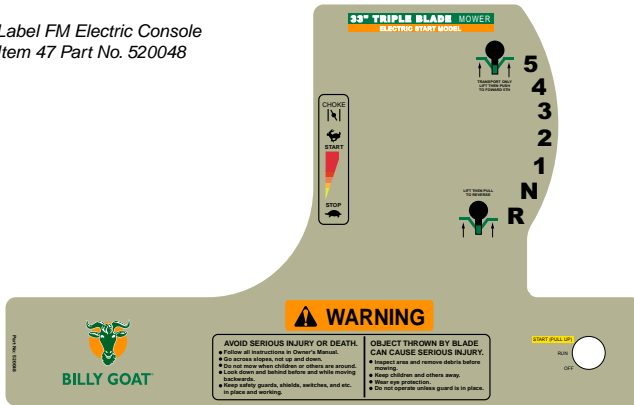

Label FM Console
Item 47 Part No. 520079

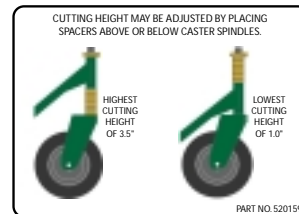

Label Hgt. Guideline
Item No. 7 Part No. 520159

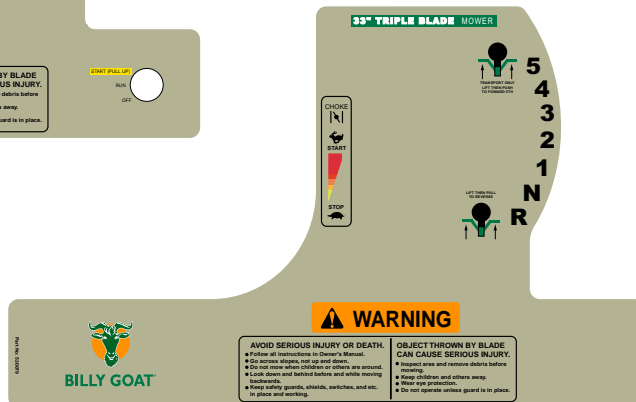

OPERATION

INTENDED USE: This unit is mainly designed for cutting grass. Some overgrown weeds, and taller grass may also be cut. Be sure to inspect work area and machine before operating. Make sure that all operators of this equipment are trained in general machine use and safety.

 Like all mechanical tools, reasonable care must be used when operating machine. Do not operate unit in areas where bystanders may be present.

Do not operate if excessive vibration occurs. If excessive vibration occurs, shut engine off immediately and check for damaged or worn blade, loose blade jam nut, loose engine or lodged foreign objects. Note: See maintenance section for proper blade jam nut torque specifications.

16.1 STARTING



CLOSE & TWIST LOCK OIL DRAIN VALVE.



PUT OIL IN ENGINE THEN CHECK THE LEVEL BEFORE STARTING.

 **ENGINE:** See engine manufacturer's instructions for type and amount of oil and gasoline used. Engine must be level when checking and filling oil and gasoline.

ENGINE SPEED: Controlled by throttle lever on the control console plate.

FUEL VALVE: Move fuel valve to "ON" position (when provided on engine).

CHOKE: Operated with the throttle control by moving the throttle control to the full start position.

THROTTLE: Move remote throttle control to fast position. Pull starting rope to start engine.

ELECTRIC START: Choke the engine if necessary. Pull up then push forward on the toggle switch until engine starts, then release switch to run.

1. Select desired cutting height before starting engine.
2. Place mower on a sidewalk or driveway where the mower blade is in an unloaded condition. If it must be started on the lawn, move mower over previously cut grass.
3. Be sure drive lever or blade lever are not engaged.
4. Choke if necessary.
5. Pull back on starter rope slowly until resistance is felt. Then pull cord rapidly to start. Repeat if necessary.

16.2 CUTTING OPERATION



CAUTION: Stop Blade when crossing gravel drives, walks or roads and under all conditions where thrown objects might be a hazard.



CLEARING A CLOGGED CUTTING DECK: Turn engine off and wait for blade to stop completely. Disconnect spark plug wire.



Wearing durable gloves, remove clog.

Danger, the clog may contain sharp materials. Reconnect spark plug wire.



CAUTION: Use extreme care when operating the blade. Inspect the work area for foreign objects that could cause damage to the unit or injure the operator if struck by the blade. Never operate the blade with bystanders in the work area.

GENERAL OPERATION: To engage the blade, depress the operator's left hand control lever against operator's handle. The blade is disengaged by releasing this lever. (See Fig. 1.1) To engage the wheel drive, lift the operator's right hand control lever against operator's handle. The drive is disengaged by releasing this lever. (See Fig. 1.2) Ground speed can be varied by shifting gears as described on page 8. To begin cutting, engage the blade lever, allow the blade to spin up to speed, and engage the wheel drive to begin moving forward into the material to be cut.

NOTE: Do not engage blade during transport between work sites. The blade should remain disengaged at all times when work is not being performed.

The best performance is achieved when cutting in dry conditions. If the deck becomes choked with grass or debris during operation, back unit off of debris allowing machine to clear itself and continue cutting, or shut the unit off and clear the clog by hand (See above). A drop in engine RPM or a noticeable change in engine sound is usually a good indicator of a clogged discharge or other interference.

Under most conditions cutting should be done in second or third gear. Fourth gear should be reserved for conditions where grass is thinned out or not as tall. The quality of the cut produced is directly related to the unit's ground speed during cutting. If the quality of the cut is not satisfactory (i.e. material left standing) you should shift into a lower gear during cutting. For improved control in confined areas, this machine can be pushed forward or backward by releasing the drive lever located at the bottom of the operator's right-hand handle while depressing the brake release lever.

16.3 CUTTING HEIGHT ADJUSTMENT

CAUTION: DO NOT make cutting height adjustment when engine is running.

Cutting height can be adjusted from 1.0" to 3.5" by placing spacers above or below caster spindles. For easiest adjustment change the height on one side at a time. To change cutting height, tilt the unit back, remove lynch pin, remove all spacers then set it off to the side, remove caster rig, add or subtract spacers, reinstall caster rig, place remainder of spacers if any, then reinsert lynch pin (see figure 16-1 through 16-4). Repeat this step on other side.

NOTE: Be sure that the spacers are even on both casters. Running the deck out of level will result in poor cut quality and increased belt wear.

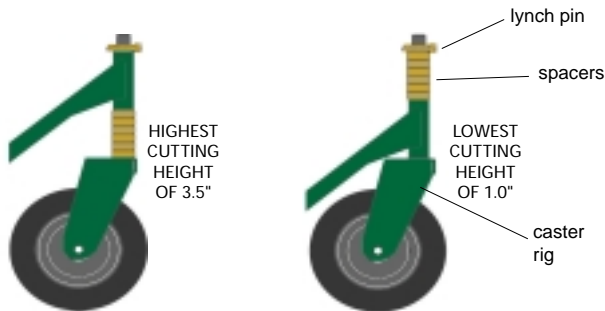

Figure 16-1



Figure 16-2



Figure 16-3



Figure 16-4

16.4 BLADE CLUTCH

The FM mower blade clutch is controlled by an operator presence control. To engage the blade, depress the operator's left hand control lever against operator's handle. The blade is disengaged by releasing this lever. (see figure 16-5)

NOTE: The blade clutch must be either fully engaged for cutting or fully disengaged to bring the blade to a stop. Do not operate the unit with the blade clutch partially engaged. Premature belt wear and clutch failure will result from improper operation of the clutch.

CAUTION: Use extreme care when operating the blade. Inspect the work area for foreign objects that could cause damage to the unit or injure the operator if struck by the blade. Never operate the blade with bystanders in the work area. Lever operate the blade without either the discharge deflector chute or the grass catcher in place.

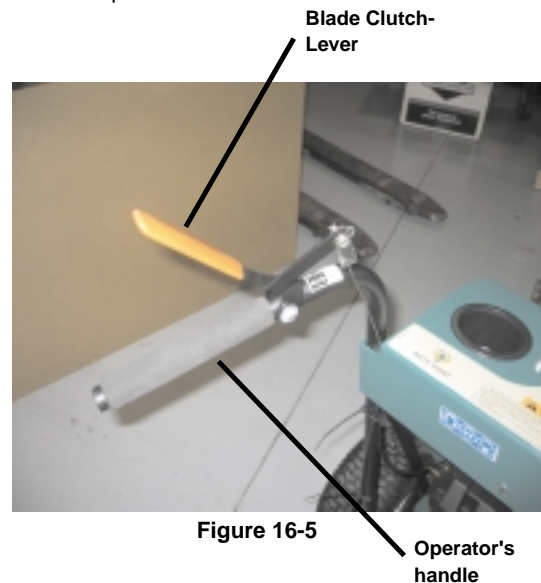

Figure 16-5

Operator's handle

16.5 PROPULSION

This unit is self-propelled, and is controlled by an operator presence control. To engage the wheel drive, first push down on the BRAKE RELEASE lever on the right side, then lift the operator's DRIVE lever on the right side against operator's handle. The drive is disengaged by releasing the lower lever. (see figure 16-6). Push and hold the Brake lever to free wheel.

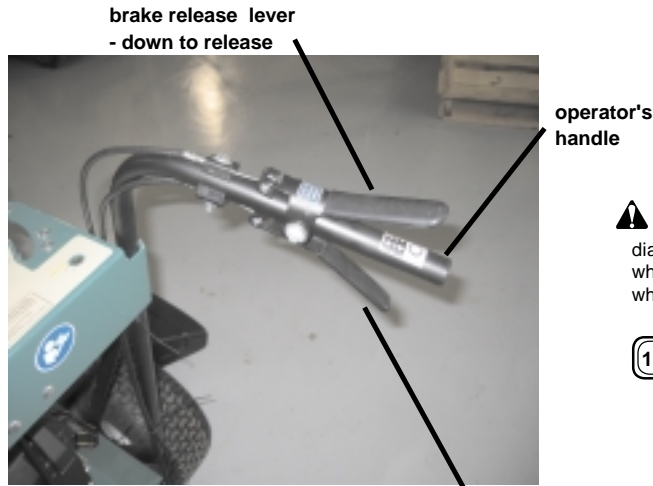

Figure 16-6

drive lever -
up to drive

GROUND SPEED can be varied by selecting a higher or lower gear using the gear shift lever on top of the console (see figure 16-7). Under most conditions cutting should be done in second or third gear. Fourth gear should be reserved for conditions where grass is thinned out or not as tall. The quality of the cut produced is directly related to the unit's ground speed during cutting. If the quality of the cut is not satisfactory (i.e. material left standing), you should shift into a lower gear during cutting. For improved control in confined areas, this machine can be pushed forward or backward by releasing the drive lever located at the bottom of the operator's right-hand handle while depressing the brake release lever.



Figure 16-7

16.6 HILLSIDE MOWING

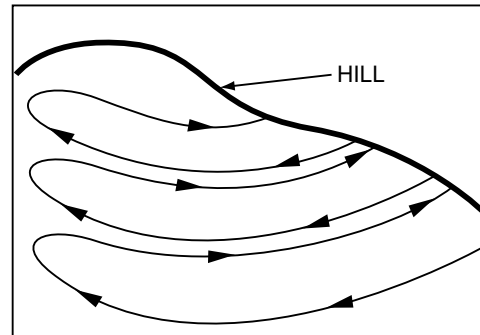

Figure 16-8

- WARNING!** Never mow on any slope greater than 15 degrees. Always mow across the face of slopes; never up and down or diagonally (see figure 16-8). DO NOT attempt sudden starts or stop when mowing on a slope. Avoid sudden turns and use extreme caution when changing direction on a slope.

16.7 HANDLING & TRANSPORTING:



CAUTION: ENGINE MUST BE OFF while handling, lifting, or transporting the unit on or off the vehicle.

Using two people to lift machine is recommended. Lift holding the handle and front of deck. Secure in place during transport.

16.8 STORAGE

- WARNING!** Never store engine indoors or in enclosed poorly ventilated areas with fuel in tank, where fuel fumes may reach an open flame, spark or pilot light, as on a furnace, water heater, clothes dryer or other gas appliance. **If engine is to be unused for 30 days or more, prepare as follows:**

- WARNING!** Be sure engine is cool. Do not smoke. Remove all gasoline from carburetor and fuel tank to prevent gum deposits from forming on these parts and causing possible malfunction of engine. Drain fuel outdoors, into an approved container, away from open flame. Run engine until fuel tank is empty and engine runs out of gasoline.

NOTE: Fuel stabilizer (such as Sta-Bil) is an acceptable alternative in minimizing the formation of fuel gum deposits during storage. Add stabilizer to gasoline in fuel tank or storage container. Always follow mix ratio found on stabilizer container. Run engine at least 10 min. after adding stabilizer to allow it to reach the carburetor.

- WARNING!** **CAUTION: Wheels must be chocked or blocked when unit is parked on a slope.**

MAINTENANCE



Use only a qualified mechanic for any adjustments, disassembly or any kind of repair .



DISCONNECT SPARK PLUG WIRE BEFORE SERVICING UNIT.



WARNING: TO AVOID PERSONAL INJURY, ALWAYS TURN MACHINE OFF, MAKE SURE ALL MOVING PARTS COME TO A COMPLETE STOP.



RECONNECT SPARK PLUG WIRE, AND ALL GUARDS BEFORE STARTING ENGINE.



WARNING: FOLLOWING ENGINE OIL CHANGE BE SURE OIL DRAIN VALVE IS CLOSE & TWIST LOCKED.

Note: Blade, blade brake puck, transaxle brake, and drive belts are normal wear items. These should be inspected on a regular basis and replaced if worn.

MAINTENANCE HISTORY	
Date of Service	Service Performed



ADJUST ALL BELT TENSIONS AFTER FIRST 5 HRS. OF USE TO PROLONG THE LIFE OF BELTS.

Maintenance Operation	Follow these hourly maintenance intervals.				
	Every Use	Every 5 hrs or (Daily)	Every 25 hrs	Every 50 hrs	Every 200-250 hrs
Engine (See Engine Manual)					
Check for excessive vibration		●			
Inspect for loose parts		●			
Inspect for worn/damaged parts	●				
Sharpen Blade			●		
Inspect belts for wear			●		
Replace blade and traction belts					●
Grease caster pivots and lubricate height adjustment spacers			●		
Lubricate pivot points of all three control levers			●		
Check tire pressure			●		
NOTE: inflate to mfr.'s specification as shown on tire side-wall			●		
Check brake puck				●	
Check parking brake				●	

17.1 CABLE ADJUSTMENTS



CAUTION: DO NOT make cable adjustment when engine is running. Disconnect spark plug wire before making any adjustments.

Brake Adjustment

The brake control cable is spring loaded and requires no adjustment; however, the transaxle brake is adjustable. When the mower is in neutral and can be pushed by hand without depressing the brake lever, the transaxle brake needs adjustment.

Using a ½ inch wrench turn the adjusting nut ¼ turn clockwise (see figure 17-1).

With the machine in neutral and:

1. The brake lever not depressed, the brake should be on and inhibit the machine from being rolled by pushing.
2. The brake lever depressed the brake should be off and the machine should roll uninhibited by the brake.



Figure 17-1

Transaxle Drive Control Cable Adjustment

When the transaxle drive belt slips, the drive control cable needs to be adjusted or the belt needs to be replaced with a new belt.

Cable Adjustment:

1. Using a 3/8" wrench, remove the rear access door (Item 51).
2. Using a ½ " open end wrench, turn the inside adjusting nut counter-clockwise and back it off 1/8", then tighten the outboard adjusting nut against the support bracket (see figure 17-2).
3. Check for proper operation. If the operation is not correct, repeat step 2.
4. Replace the access door.

The drive control cable adjustment should be the minimum amount required so the belt does not slip when the drive is engaged.



Figure 17-2

Blade Drive Control Cable Adjustment

When the blade drive control lever is depressed, the blades should turn and the blade drive belt should not slip. When the cable is properly adjusted the tension spring on the end of the control cable will open slightly (only enough for a piece of paper to slip between the coils). See figure 17-3.

Cable Adjustment:

1. Remove the deck belt cover (Item 81).
2. Observe the tension spring on the end of the cable when the blade drive lever is depressed. The spring should just break open.
3. If adjustment is required, using a ½" open end wrench, turn the inboard adjustment nut counter-clockwise and back it off 1/8" (Figure 4). Then tighten the outboard adjustment nut against the cable support bracket (Item 49).
4. Check the spring tension with the blade drive lever depressed.
5. Readjust the control cable as needed for proper tension.
6. Replace the deck belt cover.

Note: Too much tension will shorten belt and bearing life and too little tension will allow the belt to slip.



Figure 17-3

17.2 STARTER SWITCH WIRING

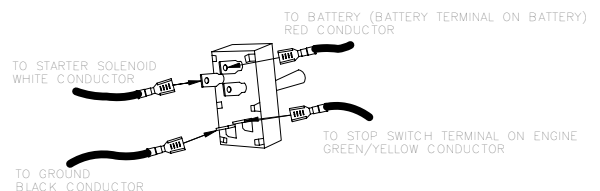

17.4 BLADE REMOVAL / SHARPENING

▲ NOTE: When sharpening the blade it is a good idea to check the balance of the blade. A properly balanced blade will increase life of the bearings and other components.

Tools required: ratchet, 3/4" inch socket, torque wrench, adequate support, block to inhibit blade rotation.

1. Disconnect spark plug wire.
 2. Support front of unit to allow access to the blades.
- Note: Unit is heavy. Be sure support is adequate to prevent personal injury.
3. Block the blade to prevent it from rotating during removal (see figure 17-4).

For Each Spindle:

4. Remove the blade bolt (Item 35), lock washer (33), and large friction washer (103).
5. Remove the blade (18) and replace or sharpen the blade.
NOTE: Use only B.G.I. Part no. 520001 (Standard blade) or B.G.I. Part no. 520002 (Mulch blade).
6. Reinstall the blade using all fasteners in the exact order they were removed (see figure 17-4).
7. Torque blade screw to 60 ft-lbs.

- NOTE:** Before installing the fasteners inspect them for wear and replace as necessary.
8. Reconnect spark plug wire.

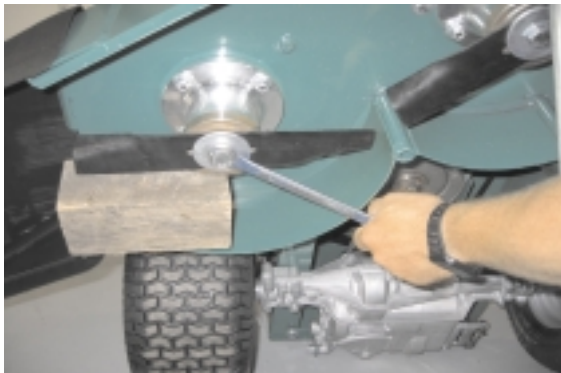

Figure 17-4



Figure 17-5

17.5 BELT REPLACEMENT

When replacing one belt the other should be inspected for wear and replaced if worn. It is good practice to change both belts when either is worn beyond use. Use only original equipment belts for replacement. Billy Goat uses only premium quality, kevlar corded and coated belts in your unit. **Substitute belts do not meet the design and performance requirements for your unit , and will greatly reduce machine performance and belt life.**

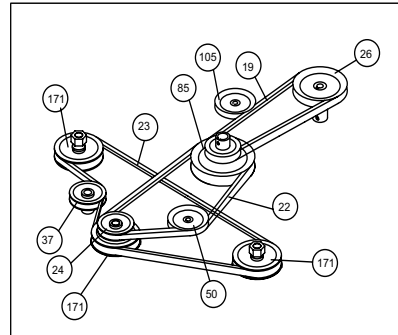

Figure 17-6

Blade Drive Belt Replacement

Tools required: ratchet, 3/4 inch socket, 10" extension bar for socket, two 1/2" wrenches and adequate support for machine.

1. Disconnect spark plug wire.
 2. Remove the deck belt cover.
 3. Support front of unit to allow access to underside of the machine near the engine.
- Note: Unit is heavy. Be sure support is adequate to prevent personal injury.
4. Observe the orientation of the belt fingers (Item 90) under the engine.
 5. Remove the 4 engine mount bolts (Item 48) being careful not to let engine slide out of place.
 6. Remove the left and right belt fingers (These fingers are interchangeable).
 7. Observe the orientation of the belt finger (Item 91) on idler (Item 50).
 8. Loosen but do not remove idler/belt finger retaining nut (Item 144).
 9. Observe belt routing and remove the belt from front spindle pulley (Item 46).
 10. Remove the belt from the idler pulley and from the engine pulley.
 11. Install new belt on engine pulley, idler and front spindle pulley following the original belt routing.
 12. Position the idler belt finger centered on idler bracket and tighten the retaining nut (Item 144).
 13. Reinstall the left and right belt guide fingers under the engine base using all fasteners in the exact order they were removed.
- NOTE:** Before installing the fasteners inspect them for wear and replace as necessary.
14. Torque the four engine bolts to 40 ft-lbs.
- Note: With clutch levers engaged, be sure belt guides do not touch belts after installation.

Blade Drive Belt Replacement continued

15. Observe the idler pulley when the blade drive lever is lowered and released (see figure 17-7).

NOTE: Idler should tighten the belt when blade drive lever is pressed and the belt should be slack when the lever is released. With the lever depressed, the edge of the belt guide should not rub on the belt.

16. Replace the cover

17. Reconnect spark plug wire.

18. Start engine and check for proper operation of blade drive system.

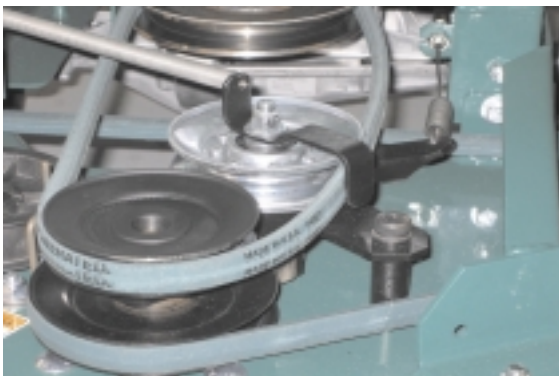

Figure 17-7

Spindle Drive Belt

Tools required: 3/8 inch socket, 1/2 inch socket.

1. Disconnect spark plug wire.
2. Follow steps to remove the Blade Drive Belt (on the spindle pulley side only) from the previous section.
3. Loosen the two idler plate nuts (Item 143).
4. Slide the belt idler to release the belt tension.
5. Observe the belt routing, then remove the old belt and install the new belt using the original routing.
6. Tension the belt using a long screwdriver or other pry bar to push the idler pulley against the belt.
- Note:** Take care not to damage the idler pulley.
7. Tighten the two idler plate nuts just enough to avoid slippage while checking the belt tension.
8. Check belt deflection. Finger pressure should give 0.5" to 0.75" (see figure 17-8).
9. Increase/decrease belt tension for proper deflection.
10. Finish Tightening the two idler plate nuts.
11. Follow steps to reinstall Blade Drive Belt from the previous section.
11. Replace cover.
12. Reconnect spark plug wire.



Figure 17-8

Transaxle Drive Belt Replacement

Tools required: 1/2 Wrench or ratchet and 1/2 inch socket, adequate support for machine.

1. Remove the Blade Drive Belt (Steps 1-10: Blade Drive Belt Replacement Procedure).
2. Assure that spark plug wire is disconnected.
3. Support rear of unit to allow access to underside of the machine near the rear.

Note: Unit is heavy. Be sure support is adequate to prevent personal injury.

4. Observe the belt fingers (Item 63), position of idler and belt routing.
5. Remove the belt finger retaining nuts and bolts (Items 125 and 143).
6. Remove the belt finger and remove the belt from the transaxle pulley (Item 48).
7. Remove the belt from the drive idler (Item 105).
8. Remove the belt from the engine drive pulley (Item 85).

9. Install new belt on the top (small) engine pulley, drive idler and transaxle pulley using the original belt position and routing.

10. Reposition and secure the belt finger (Item 63) using the original bolts, washers and nuts.

NOTE: Before installing the fasteners inspect them for wear and replace as necessary.

11. Reinstall the Blade Drive Belt (Steps 11-16: Blade Drive Belt Replacement Procedure).

Note: With clutch levers engaged, be sure belt guides do not touch belts after installation.

12. Replace the cover

13. Reconnect spark plug wire.

14. Start engine and check both belts for proper operation of blade drive system and mower drive system.

WARNING: If the drive belt begins to squeal or slip, do not continue to operate your unit until adequate adjustment or repair has been performed. Improper adjustment can cause drive belt to slip and overheat, greatly reducing machine performance and transmission life.

BRAKE PUCK REPLACEMENT

Tools Required: 5/32" Allen wrench; 3/8" wrench.

1. Remove the spark plug wire.
2. Remove the belt deck cover.
3. Remove the brake spring (A) and control cable spring (B) (see figure 17-10).
4. Remove the blade drive belt (C) from the drive pulley (D).
5. Using a 3/8" wrench and 5/32" allen wrench, remove the nuts from the #10 puck retaining bolts (see figure 17-11).
6. Remove the bolts from the puck.
7. Remove the brake puck.

Note: The puck ends are symmetrical and can be interchanged to use a new braking surface unless both ends are already worn (Figure 4). When both ends have been used replace the puck with a new one.

8. Inspect the nylon brake arm spacer (Item 44) by removing the belt finger (Item 91) and idler pulley (Item 50).
9. Replace the spacer if it shows signs of wear.
10. Reassemble all parts in the same orientation as when removed.

Note: Be sure that the brake puck is centered and contacts both sides of the pulley groove after tightening.

Note: Before installing fasteners, inspect them for wear and replace as necessary. Be sure that when reinstalling control cable spring (B), the open side of the spring hook faces up.

11. Check the operation of the clutch and brake mechanism. The drive belt should be slack and the brake engaged (center pulley will not turn easily by hand) when no pressure is exerted on blade drive lever.

Note: When the blade drive lever is depressed, the brake puck should not rub on the center pulley, the belt should be under tension, and not rub on the belt finger (see figure 17-10).

13. Replace the belt cover and connect the spark plug wire. Start the engine and check the clutch/brake operation under power.

Note: When the blade clutch control lever is pressed down, the blades should spin up to speed without belt slippage indicated by a pronounced belt squealing sound. When the clutch control lever is released, the blades should stop spinning in 5 seconds or less.

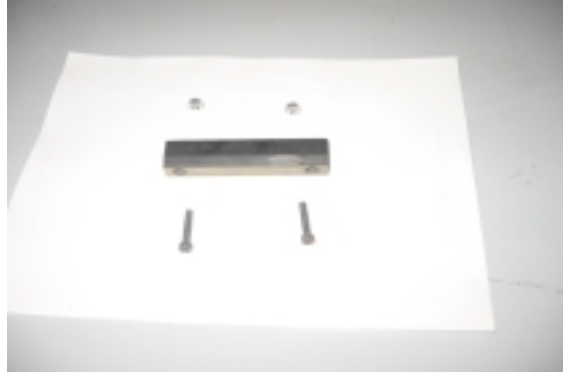

Figure 17-9

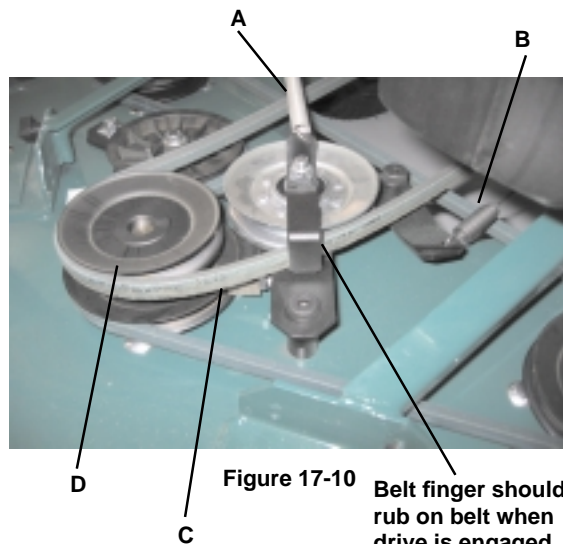

Figure 17-10

Belt finger should not rub on belt when drive is engaged.

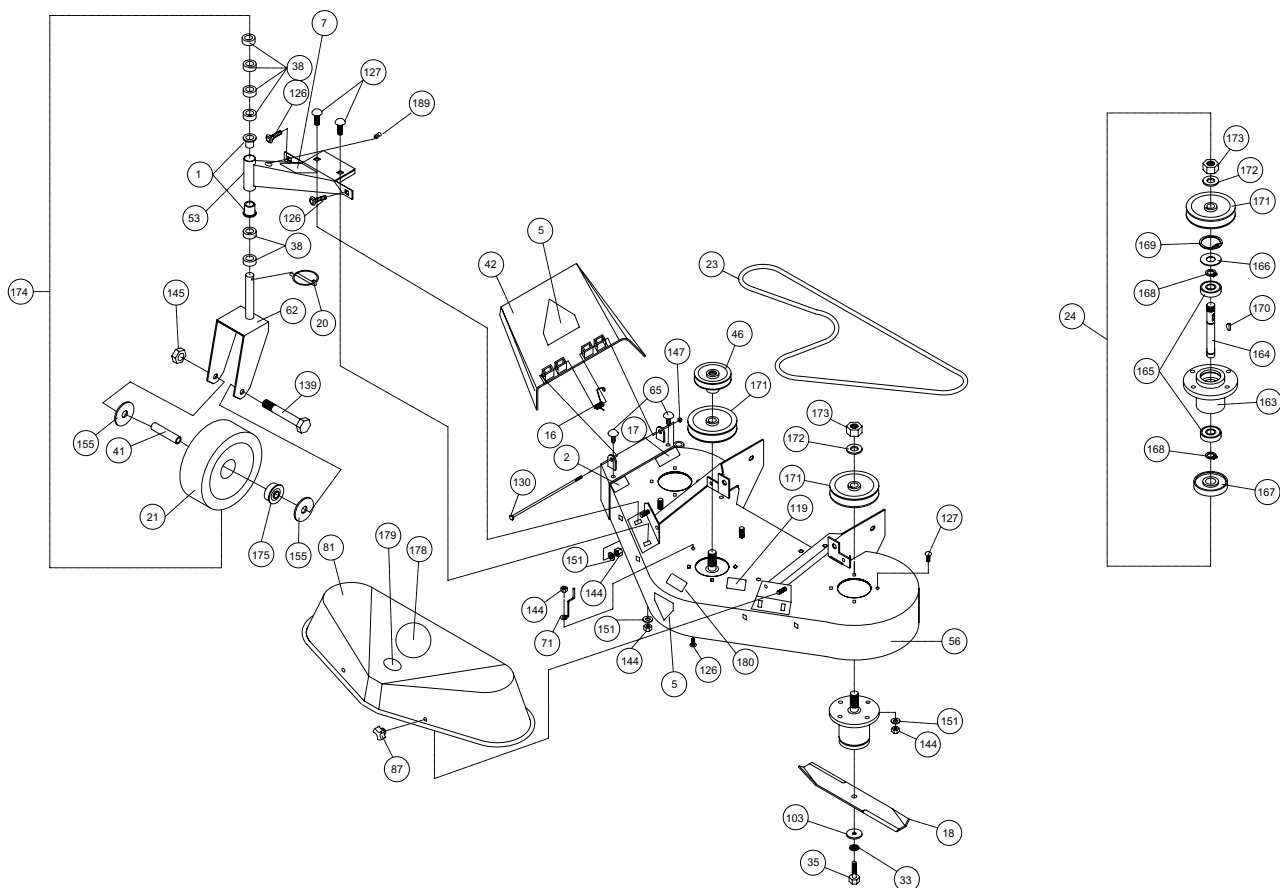

Figure 17-11



18 PARTS DRAWING

**FM3301IN & FM3301INE
DECK ASSEMBLY**



ITEM NO.	DESCRIPTION	FM3301INE QTY	FM3301IN QTY	ITEM NO.	DESCRIPTION	FM3301INE QTY	FM3301IN QTY
		PART NO.	PART NO.			PART NO.	PART NO.
1	BUSHING BRONZE	520184	4	126	BOLT CARRIAGE 3/8-16X1" ZP	8024058	5
2	LABEL DANGER FLY	810736	1	127	BOLT CARRIAGE 3/8-X 1 1/4	8024059	16
5	LABEL WARNING	400424	2	130	SCREW CAP 1/4 - 20 X 7"	8041023	1
7	LABEL HGT. GUIDELINE	520159	1	139	SCREW CAP 1/2-13 X 4 1/2	8041107	2
16	SPRING EXHAUST CHUTE	510205	1	144	NUT 3/8-16 LOCK NYLON	8160003	21
17	LABEL WARNING MOWER	510206	1	145	NUT 1/2-13 LOCK NYLON	8160005	2
18	BLADE 11.88"	520001	3	147	NUT 1/4-20 LOCK NYLON	8160001	1
20	LYNCH PIN 3/16" X 1 9/16	520004	2	151	WASHER 5/16" FC	8171003	20
21	WHEEL AND TIRE 8" ASSY.	520005	2	155	WASHER 3/4 FC	8172015	4
23	BELT SPINDLE DRIVE	520007	1	163	HOUSING SPINDLE	520008-01	3
24	SPINDLE ASSY FM	520008	3	164	SHAFT SPINDLE 1215 C. D. S.	520008-02	3
33	WASHER 1/2 INNER TOOTH	520025	3	165	BEARING BALL 6305-25	520008-03	6
35	SCREW CAP 1/2-20X1.25	520028	3	166	WASHER	520008-04	3
38	BUSHING CASTER SPACERS	520034	12	167	SHIELD	520008-05	3
41	SPACER FRONT CASTER	520041	2	168	RETAINING RING	520008-06	6
42	EXHAUST CHUTE DEFLECT.	520042	1	169	RETAINING RING	520008-07	3
46	PULLEY DECK FRONT DRIVE	520047	1	170	WOODRUFF KEY # 605	520008-08	3
53	CASTER ARM FM WA ?	520067-S	2	171	PULLEY 4.75" DIA. 3/4" BORE	520008-09	3
56	DECK WA W/ LABELS	520071-S	1	172	MACHINERY BUSHING 3/4"	520008-10	3
62	BRACKET CASTER FM WA	520161	2	173	NUT 3/4-16 NYLON HEX	520008-11	3
65	PLUG 3/8" BUTTON HEAD	520081	2	174	FRONT CASTER ASSY.	520140	2
71	WIRE BELT FINGER	520088	1	175	BEARING CASTER WHEEL	520124	4
81	GUARD BELT W/ LABELS FM	520100-S	1	178	LABEL BGI BIG CIRCLE	430303	1
87	KNOB 3 PRONG 1/4"	520109	4	179	LABEL 33" CUT FM	520115	1
103	WASHER 1/2" X 2	610308-P	3	180	LABEL MADE IN USA	520116	1
119	LABEL DANGER	900327	1	189	FITTING GREASE	610363	2



18 PARTS DRAWING

FM3301IN & FM3301INE ENGINE ASSEMBLY

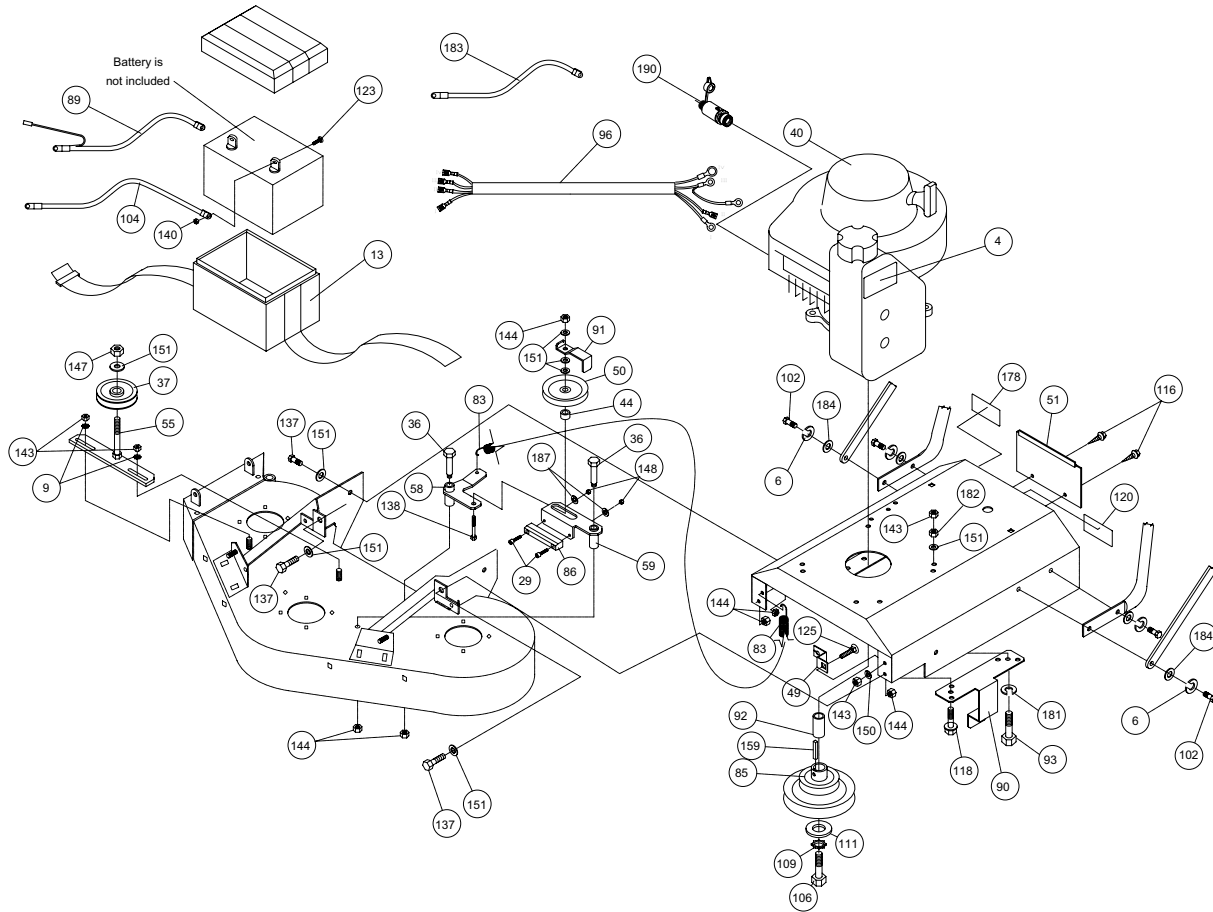

ITEM NO.	DESCRIPTION	FM3301INE QTY	FM3301IN QTY	ITEM NO.	DESCRIPTION	FM3301INE QTY	FM3301IN QTY
		PART NO.	PART NO.			PART NO.	PART NO.
4	LABEL DO NOT FILL HOT	400268	400268	106	SCREWCAP 7/16 X 2 1/4 GR 8	830114	830114
6	WASHER SPLIT LOCK 3/8"	8177012	8177012	109	WASHER LOCK 7/16 TWIST	850132	850132
9	WASHER 5/16" TWISTED LK.	430298	430298	111	WASHER ENGINE PULLEY	850443	850443
13	BOX BATTERY ASSY	500300	-	116	SCREW 1/4" - 20 X 5/8"	890359	890359
29	SCREW SOCKET #10 X 1"	520018	520018	118	SCREWCAP 3/8" 1 1/2" TAP	890408	890408
36	BOLT SHOULDER 1/2" X 2"	520031	520031	120	LABEL GUARDS	900327	900327
37	IDLER PLASTIC 4" X 0.375	520032	520032	123	BOLT CARRIAGE 1/4" X 3/4"	8024039	8024039
40	ENGINE 13 HP B&S	520169	520168	125	BOLT CARRIAGE 5/16" X 1"	8024040	8024040
44	SPACER NYLON BRAKE	520045	520045	137	SCREW CAP 3/8"-16 X 1 HEX	8041050	8041050
49	BRKT CLUTCH CABLE FM	520052	520052	138	SCREW CAP 3/8"-16 X 2 HEX	8041054	8041054
50	PULLEY IDLER BLADE DRIVE	520061	520061	140	NUT LOCK 1/4"-20 NYLON	8160001	8160001
51	PLATE ACCESS DOOR FM	520062	520062	143	NUT LOCK 5/16"-18 NYLON	8160002	8160002
55	BRKT IDLER DECK BLADE WA	520070	520070	144	NUT LOCK 3/8"-16 NYLON	8160003	8160003
58	PLATE BLADE CLUTCH IDL.	520073	520073	147	NUTLOCK 3/8"-16 LW TH ZP	8161042	8161042
59	PLATE BLADE CLUTCH BK	520074	520074	148	NUT LOCK #10	8155007	8155007
83	SPRING TENSION WIRE	520103	520103	150	WASHER 1/4" FC	8171002	8171002
85	PULLEY DOUBLE 6 / 3.5 FM	520105	520105	151	WASHER 5/16" FC	8171003	8171003
86	BRAKE PUCK FM	520106	520106	159	KEY 1/4" SQ. X 2.25" LONG	9201123	9201123
89	CABLE BATTERY POS 10"	520111	-	178	LABEL DESIGN PATENT FM	520191	520191
90	BRACKET BELT FINGER	520112	520112	181	WASHER SPLIT LOCK 5/16"	8177011	-
91	BRACKET BELT FINGER BK.	520113	520113	182	NUT JAM 5/16"	8142002	-
92	SPACER HUB 1" BORE 1.5"	520114	520114	183	POSITIVE CABLE 10"	520123	-
93	SCREWCAP 5/16" -18 x 2"	8041032	-	184	WASHER 3/8" FLATCUT	8171004	8171004
96	WIRE HARNESS	520118	-	187	WASHER #10 FLATCUT	8171001	8171001
102	SCREWCAP 3/8" - 1.25"	8041051	8041051	190	VALVE OIL DRAIN	520182	520182
104	CABLE BATTERY BLACK 10"	790133	-				



18 PARTS DRAWING

**FM3301IN & FM3301INE
DRIVE ASSEMBLY**

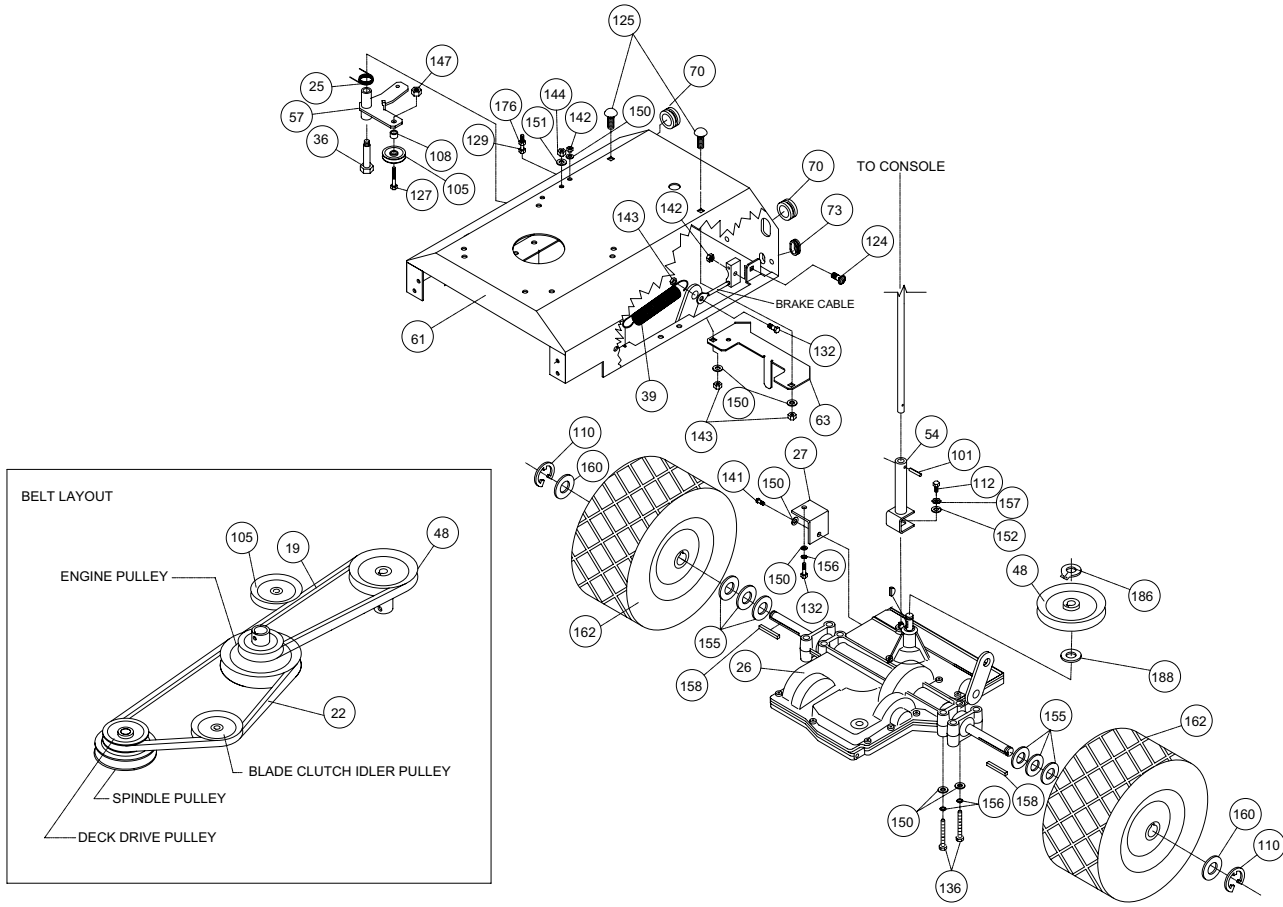

ITEM NO.	DESCRIPTION	FM3301INE QTY	FM3301IN QTY	ITEM NO.	DESCRIPTION	FM3301INE QTY	FM3301IN QTY
		PART NO.	PART NO.			PART NO.	PART NO.
19	BELT TRANS DRIVE FM	520003	520003	127	SCREWCAP 3/8-16 X 1 3/4	8041053	8041053
22	BELT BLADE DRIVE FM	520006	520006	129	SCREWCAP 1/4"-20 X 2.75"	8041013	8041013
25	SPRING TORSION WIRE	520009	520009	132	SCREWCAP 5/16-18 X 1.25"	8041029	8041029
26	TRANSAXLE 5SPD FM	520010	520010	136	SCREW CAP 5/16 - 18 x 2.75	8041035	8041035
27	BRACKET T-AXLE SUPPORT	520016	520016	141	SCREW SELF TAP 5/16	8123128	8123128
36	BOLT SHOULDER 1/2" X 2"	520031	520031	142	NUT LOCK 1/4-20 NYLON	8160001	8160001
39	SPRING BRAKE	520037	520037	143	NUT LOCK 5/16-18 NYLON	8160002	8160002
48	PULLEY 5" OD "A" SEC. FM	520181	520181	144	NUT LOCK 3/8-16 NYLON	8160003	8160003
54	SHIFT LINKGAGE FM	520068	520068	147	NUTLOCK 3/8"-16 LW TH ZP	8161042	8161042
57	BRKT IDLER GRND DRIVE	520072	520072	150	WASHER 1/4" FC	8171002	8171002
61	BASE ENGINE W/INSERTS	520177	520177	151	WASHER 5/16" FC	8171003	8171003
63	BRACKET BELT GUIDE DRV	520078	520078	152	WASHER 1/4 SAE	8172007	8172007
70	GROMMET RUBBER 1"	520087	520087	155	WASHER 3/4 FC	8172015	8172015
73	GROMMET RUBBER 1.25"	520092	520092	156	WASHER LOCK 5/16 SPLIT	8177011	8177011
101	ROLL PIN 1/4" X 1.0 IN LONG	520156	520156	157	WASHER LOCK 1/4" EXT.	8181007	8181007
105	PULLEY IDLER TENSION	800260	800260	158	KEY 3/16 x 2 1/8	9201087	9201087
108	TUBE PIVOT IDLER VQ	830526	830526	160	WASHER 3/4 THIN	850238	850238
110	RING SNAP 0.75	850230	850230	162	WHEEL AND TIRE 13"	830177	830177
112	SCREW CAP 1/4-28X1/2" GR 5	850408	850408	176	NUT JAM 1/4-20	8143001	8143001
124	BOLT CARR. 1/4-20X1.25"	8024023	8024023	186	RING SNAP 5/8 T.A.	850233	850233
125	BOLT CARR. 5/16-18X1"	8024058	8024058	188	WASHER 3/4	850230	850230



18 PARTS DRAWING

**FM3301IN & FM3301INEB
HANDLE ASSEMBLY**

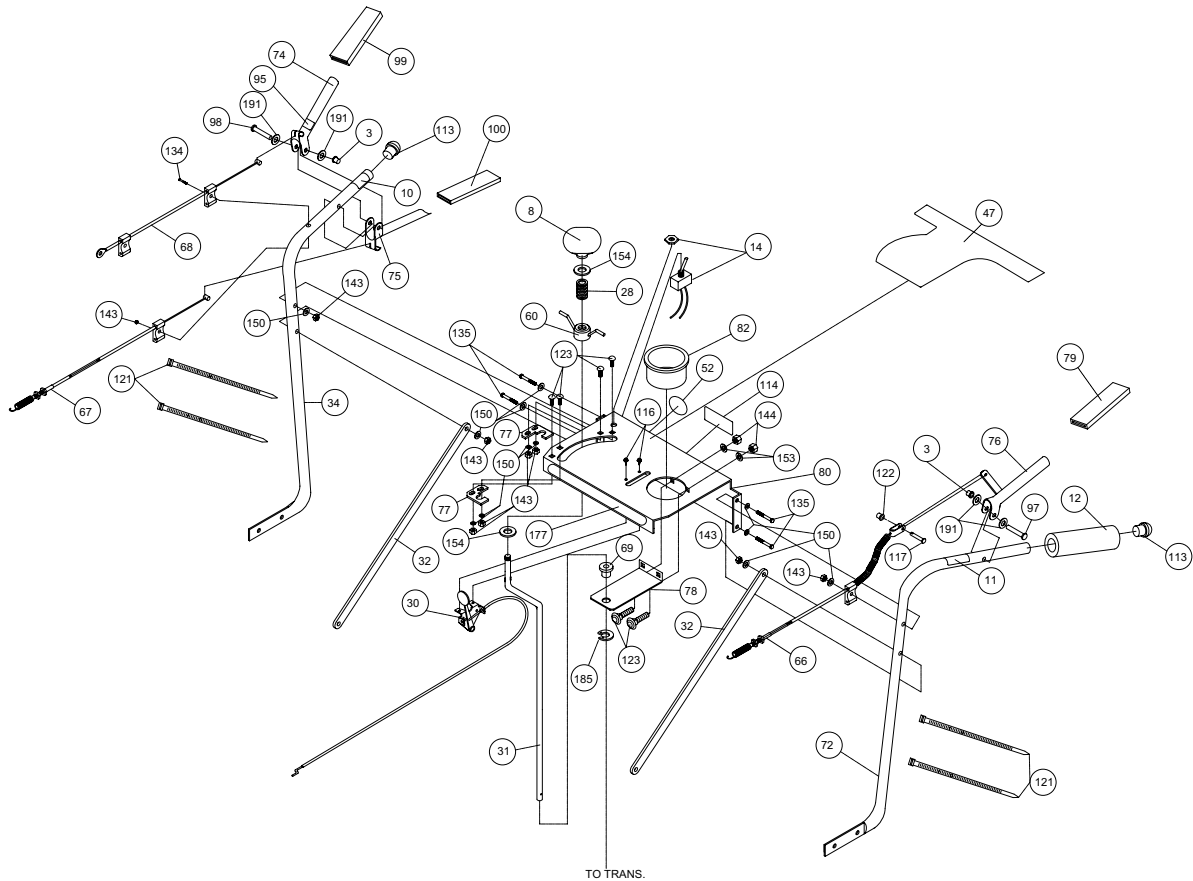

TO TRANS.

ITEM NO.	DESCRIPTION	FM3301INE QTY	FM3301IN QTY	ITEM NO.	DESCRIPTION	FM3301INE QTY	FM3301IN QTY
		PART NO.	PART NO.			PART NO.	PART NO.
3	PALNUTS 3/8"	360218	2	80	CONSOLE FM W/ LABELS	520146	1
8	KNOB 1/2" THREAD	430128	1	82	CUP HOLDER	520102	1
10	LABEL CLUTCH DRIVE	500176	1	95	LABEL PUSH TO RELEASE	520117	1
11	LABEL BLADE DRIVE	500177	1	97	CLEVIS PINS 3/8 - 1.625	520119	1
12	GRIP HANDLE 1" x 7"	500267	1	98	CLEVIS PINS 3/8 - 2.125	520120	1
14	SWITCH ELECTRIC W/ NUT	500307	1	99	GRIP LEVER 0.125-1.00-3.75	520121	1
28	SPRING COMPRESSOR 1/2"	520017	1	100	GRIP LEVER 0.125-0.75X3.75	520122	1
30	CONTROL THROTTLE POS	520019	1	113	PLUG TUBE INSERT 1"	890132	2
31	ROD SHIFT LINKGAGE	520179	1	114	LABEL EAR-EYE-BREATHE	890254	1
32	BAR HANDLE BRACE FM	520024	2	116	SCREW 1/4" - 20 X 5/8	890359	2
34	HANDLE RH FM	520026-S	1	117	PIN CLEVIS 5/16-24	830513	1
47	LABEL CONSOLE	520048	1	121	TY-WRAP	900407	4
52	LABEL READ MANUAL	890301	1	122	PAL NUTS 5/16"	360203	1
60	SHIFT LOCK HANDLE FM WA	520075	1	123	BOLT CARRIAGE 5/16-18 X 3/4	8024039	6
66	CABLE CLUTCH BLADE FM	520083	1	134	SCREW CAP 5/16-18 X 2	8041032	1
67	CABLE CLUTCH DRIVE FM	520084-S	1	135	SCREWCAP 5/16-18 x 2 1/4	8041033	4
68	CABLE CLUTCH BRAKE FM	520085	1	143	NUT LOCK 5/16-18 NYLON	8160002	9
69	BUSHING NYLON	500130	1	144	NUT LOCK 3/8-16 NYLON	8160003	2
72	HANDLE LH FM	520091-S	1	150	WASHER 1/4" FC	8171002	12
74	LEVER CONTROL BRAKE FM	520093-S	1	153	WASHER 5/16 SAE	8172008	2
75	LEVER CONTROL DRIVE FM	520094	1	154	WASHER 1/2" SAE ZP	8172011	2
76	LEVER CONTROL BLADE FM	520095	1	177	LABEL BGI OVAL FM	520110	1
77	PLATE REV LOCK OUT	520096	2	185	RETAINING RING EXTERNAL	520176	1
78	BRACKET SHIFT PIVOT FM	520097	1	191	WASHER 5/16" FC	8171003	4
79	GRIP LEVER ORANGE	520098	1				

19.1 GRASS CATCHER KIT 520142

Purpose: Easily convert your mower to bag grass and leaves.

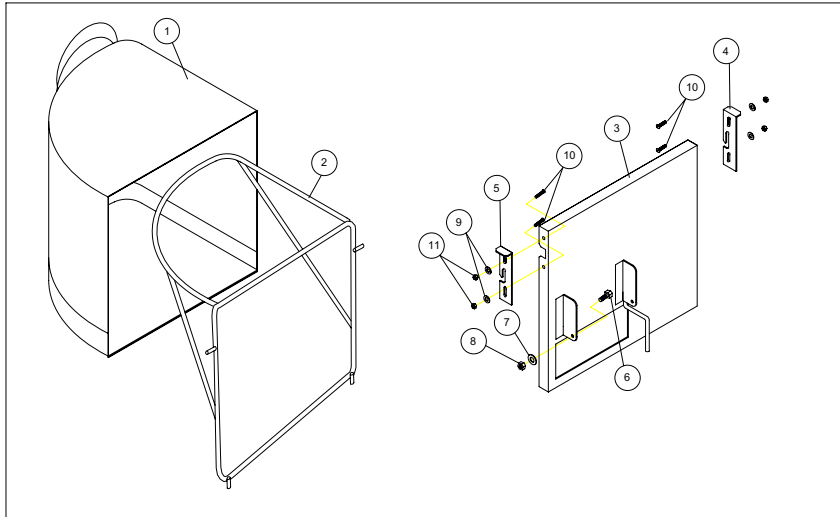

Item No.	Part No.	Description	Qty
1	520012	GRASS CATCHER BAG	1
2	520038	WIRE FRAME GRASS CATCHER FM	1
3	520069	GRASS CATCHER MOUNT WA FM	1
4	520059	BRACKET GRASS CATHCER LATCH L FM	1
5	520060	BRACKET GRASS CATHCER LATCH R FM	1
6	8041006	SCREWCAP 1/4" - 20 X 1" ZP	1
7	8171002	WASHER 1/4" FC ZP	1
8	8160001	NUTLOCK 1/4" - 20	1
9	520126	WASHER #8 SAE	4
10	520128	SCREW ROUND HEAD #8-32 X 3/4" CLEAR ZINC	4
11	520129	NUTLOCK #8 - 32	4
12	520147	LIT GRASS CATCHER KIT FM	1

19.2 MULCHING KIT 520144

Purpose: Reduces lawn clippings to fine nutrient-rich particles that filter down to the soil.

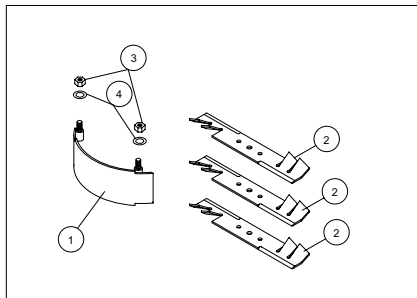

Item No.	Part No.	Description	Qty
1	520014	MULCHING PLATE WA FM	1
2	520002	BLADE 11.88" MULCHING	3
3	8161042	NUTLOCK 3/8"-16 THIN HGT	2
4	8171003	WASHER 5/16 FC	2
5	520148	LIT MULCHING KIT FM	1

19.3 TRANSAXLE GUARD KIT 520155

Purpose: To protect the transaxle from accidental contact from concrete curbs or other hazards.

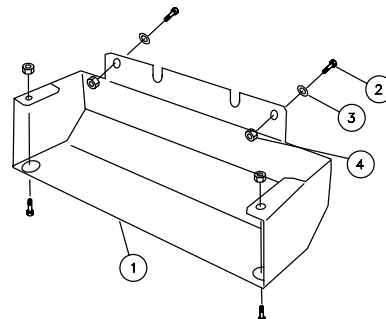

Item No.	Part No.	Description	Qty
1	520151	BRACKET GUARD TRANSAXLE FM	1
2	8041028	SCREWCAP 5/16-18X1"	4
3	8171002	WASHER 1/4 FC	2
4	8160002	NUTLOCK 5/16 - 18	4

NOTE: For repairs beyond the minor adjustments listed below, contact your nearest authorized service dealer.

Problem	Possible Cause	Solution
The engine will not start	1. Engine not properly primed. 2. Out of gasoline or bad or old gasoline. 3. Spark plug wire disconnected. 4. Dirty air cleaner. 5. Blade Clutch is engaged.	1. Prime to choke. 2. Check gasoline. 3. Check for spark with an approved tester. 4. Clean or replace air cleaner. 5. Disengage the Blade Clutch Lever.
The engine will not stop	1. Damaged control cable. 2. The Harness Wire is disconnected or damaged (electric start model) 3. Damaged ignition switch (electric start model).	1. Replace control cable. 2. Reconnect the Harness Wire or replace if damaged. 3. Replace switch.
Engine runs poorly	1. Spark plug wire loose. 2. Engine RPM set too low. 3. Carburetor out of adjustment. 4. Water or dirt in fuel system. 5. Spark plug fouled, faulty or wrong gap.	1. Sharpen or replace blade (see page 8). 2. Check engine RPM.(refer to engine manual). 3. Adjust carburetor (refer to engine manual). 4. Drain or siphon then replace with fresh gasoline. 5. Reset gap or replace spark plug (refer to engine manual).
Will not cut or has poor cutting performance.	1. Dull or bent Blade. 2. Clogged deck. 3. Engine running at too low RPM. 4. Wet grass. 5. Excessively high grass.	1. Sharpen blade or replace blade (see page 10). 2. Unclog deck (see page 6). 3. Check engine RPM (refer to engine manual). 4. Do not mow when grass is wet; wait until later to cut. 5. Mow once at a high cutting height then mow again at desired height or make a narrower cutting path.
Uneven cut	1. Height adjust is not set correctly. 2. Dull or bent blade.	1. Be sure height adjust is set the same on both sides (see page 7). 2. Sharpen blade or replace blade (see page 10).
Abnormal vibration.	1. Loose or out of balance blade. 2. Bent blade. 3. Loose engine.	1. Check blade mount and balance or replace if required. 2. Replace with the new blade (see page 10). 3. Check Engine mount.
Belt slips or smokes.	1. Belt tension too low. 2. Belt worn or stretched. 3. Pulleys worn or damaged. 4. Control Cable is out of adjustment.	1. Increase tension at idler(see page 10-11). 2. Replace belt. 3. Replace pulleys. 4. Adjust Control Cable (see page 9).
No self propelling.	1. Not set to gear. 2. Out of adjustment clutch cable. 3. Broken clutch cable. 4. Worn or broken belt.	1. Shift lever in desired gear 2. Adjust clutch cable (see page 9). 3. Replace with new cable. 4. Replace belt (see page 11).
Self propelled drive will not release .	1. Clutch cable out of adjustment. 2. Damaged Drive Clutch Lever.	1. Adjust clutch cable (see page 11). 2. Replace Drive Clutch Lever.
Engine is locked, will not pull over.	1. Debris locked against blade. 2. Damaged engine. 3. Broken control cable	1. Remove debris (see page 6). 2. Refer to your engine owner's manual. 3. Replace control cable.

ENGINE

When servicing engine refer to specific manufacturers engine owner's manual. All engine warranty is covered by the specific engine manufacturer. If your engine requires warranty or other repair work contact your local servicing engine dealer. When contacting a dealer for service it is a good idea to have your engine model number available for reference(See table page 11). If you can not locate a servicing dealer in your area you can contact the manufacturers national service organization.



To reach: Briggs & Stratton: 800-233-3723

22.1

Engine Service and Warranty
Contact your nearest engine manufacturer's authorized servicing dealer.

21

Serial Plate Record your machine model, serial number and date-of-purchase and where purchased

  100 dB		1803 S.W. Jefferson Lee's Summit, MO 64082 / USA Tel (816) 524-9666 Fax (816) 524-6983
	Model <input type="text"/> Serial No. <input type="text"/> Unit(Weight) <input type="text"/> lbs. <input type="text"/> kg Engine Power <input type="text"/> kW <input type="text"/> rpm	

Purchase Date _____ Purchased from _____

22

WARRANTY PROCEDURE

Should a Billy Goat Machine fail due to a defect in material and / or workmanship, the owner should make a warranty claim as follows:

- The Machine must be taken to the dealer from whom it was purchased or to an authorized Servicing Billy Goat Dealer.
- The owner must present the remaining half of the Warranty Registration Card, or, if this is not available, the invoice or receipt.
- The Warranty Claim will be completed by the authorized Billy Goat Dealer and submitted to their respective Billy Goat Distributor for their territory. Attention: Service Manager. Any parts replaced under warranty must be tagged and retained for 90 days.
- The distributor service manager will sign off on the claim and submit it to Billy Goat for consideration.
- The Technical Service Department at Billy Goat will study the claim and may request parts to be returned for examination. Billy Goat will notify their conclusions to the distributor service manager from whom the claim was received.
- The decision by the Quality / Service department at Billy Goat to approve or reject a Warranty claim is final and binding.

Note: To process a Warranty Claim, it is necessary to quote the Model & Serial Number which are printed on the Billy Goat Serial Plate (See owner's manual).



BILLY GOAT INDUSTRIES INC.
 PO BOX 308 LEE'S SUMMIT, MO 64063-0308 / USA
 PHONE: 816-524-9666 FAX: 816-524-6983 www.billygoat.com