



ATTO Technology, Inc.
FastStream VT 5300

Installation and Operation Manual

Fibre Channel to SCSI Virtual Tape Appliance

© 2006 ATTO Technology, Inc. All rights reserved. All brand or product names are trademarks of their respective holders. No part of this manual may be reproduced in any form or by any means without the express written permission of ATTO Technology, Inc.

Contents

1.0 ATTO FastStream VT 5300 increases reliability	1
Hardware features	
Virtual Tape features	
Backup and restore features	
Management and control features	
1.1 Physical attributes	3
Dimensions	
Cooling and airflow	
Power	
Fibre Channel port	
SCSI ports	
Ethernet port	
Serial port	
LED indicators	
2.0 Installation	5
Unpack the packing box; verify contents	
Install the FastStream	
Install Windows drivers	
Discover the IP address	
Begin initial configuration	
2.1 Configure Virtual Tape	7
Use quick initial configuration	
Use custom initial setup	
Use Hot Spare devices	
Secure data through Write Protection	
Move Virtual Tape Cartridges	
2.2 Optional changes to system parameters	11
Customize the username, password	
Change system configurations	
Advanced CLI page	
3.0 Monitor storage and diagnose configurations	13
Monitor VTL page	
Health and Status Monitor page	
Configuration Display page	
Phone home: E-mail messages	
Measure drive performance	
Scan drive surfaces	
Verify storage	

4.0 Modify storage	17
Initialize and verify drives	
Add drives to a RAID Group	
Rebuild RAID Groups	
Add or remove Hot Spares	
Add a VTL from another FastStream VTL	
Delete a VTL	
Secure data through Write Protection	
Move Virtual Tape Cartridges	
5.0 Update storage and firmware	21
Remove stale VTL configuration data	
Update firmware	
Preliminary steps	
Use FTP over Ethernet	
Use the RS-232 serial link	
6.0 Interface options	23
Use the FastStream VT 5300 GUI	
Use the serial port	
Use Telnet	
Appendix A Cabling	i
SCSI cabling	
Cable types	
Connecting SCSI devices to SCSI ports	
Fibre Channel connections	
Appendix B Designing RAID groups	iii
JBOD (Just a Bunch of Disks)	
RAID Level 0	
RAID Level 1	
RAID Level 10	
RAID Level 5	
Appendix C CLI provides an ASCII-based interface	v
CLI error messages	
CLI summary	
CLI command explanations	
Appendix D Standards and compliances	xix
FCC Standards: Radio and Television Interference	
Canadian Standards	
European Standards	
Declaration of Conformity	
Appendix E Warranty, contact information	xxi
Manufacturer limited warranty	
Contact ATTO Technology, Inc.	

1.0 ATTO FastStream VT 5300 increases reliability

The ATTO FastStream™ Virtual Tape 5300 Appliance is a mid-range storage solution that emulates a tape library for fast backups on demand and error-free restores of critical data.

The ATTO FastStream Virtual Tape 5300 is seen by system applications as a conventional tape library, allowing you to use existing disk-based storage as if it were tape.

The ATTO FastStream VT 5300 delivers immediate performance improvements to backup, restore and archive applications.

Adding a disk-based Virtual Tape Library (VTL) ensures high speed access to your data. The FastStream VT can be seamlessly integrated into existing storage environments as if it were a traditional tape library. The ATTO FastStream VT 5300 also provides high performance RAID parity protection to existing disk-based storage without regard to manufacturer, type of drive, capacity or speed.

Adding RAID ensures your data is protected without compromising performance.

The ATTO FastStream VT 5300 is available in 1U desktop and industry-standard rack-mount enclosures.

Hardware features

- Dual independent 4-Gigabit Fibre Channel Host Interfaces to integrate existing direct attached storage into a high performance SAN environment
- Dual Ultra320 SCSI device high speed connections backward compatible with Ultra160 devices
- O/S and platform independent. 64 bit OS supported

Virtual Tape features

- Seen by ISV applications as a conventional tape library.
- Configure one or two Virtual Tape libraries
- Configure up to 30 Virtual Tape drives and 256 Virtual tapes for each library.

- Hardware RAID Level 0, RAID Level 1, RAID Level 5, RAID Level 10 and JBOD, all user configurable

Backup and restore features

- Performs up to 30 concurrent backups for each virtual tape library
- SpeedWrite feature ensures responsive and error-free backup in the shortest possible time
- Backup and restore data at up to 1.5 TB per hour
- Uses reliable disk storage to take the place of conventional tape to deliver immediate performance improvements to backup and restore applications

Management and control features

- Browser-based GUI simplifies configuration, management and navigation
- Advanced Management
 - In-band SCSI, FC
 - Out-of-band through RS-232 and Ethernet
- Field updateable firmware with the ability to save configuration settings for easy field replacement
- Automatic rebuild of RAID groups and Rebuild Priority keep the system operational if a drive fails
- Global Hot Spares ensure continuous operation if a drive fails. The Hot Spare automatically comes on-line and rebuild starts if a disk failure is detected
- ECC Protected Memory assures data integrity and continued up time by implementing Error Correcting Checksum (ECC) and Parity checks on all data paths. Potential corruption cannot go undetected
- Phone Home error notification automatically generates an E-mail alert in the event of a failure
- Drive initialization and verification identifies attached drives which exhibit poor performance or soft failures
- Capable of measuring performance during normal operation and during the drive initialization process

Possible storage configurations

Ethernet 
 Fibre Channel 
 SCSI 

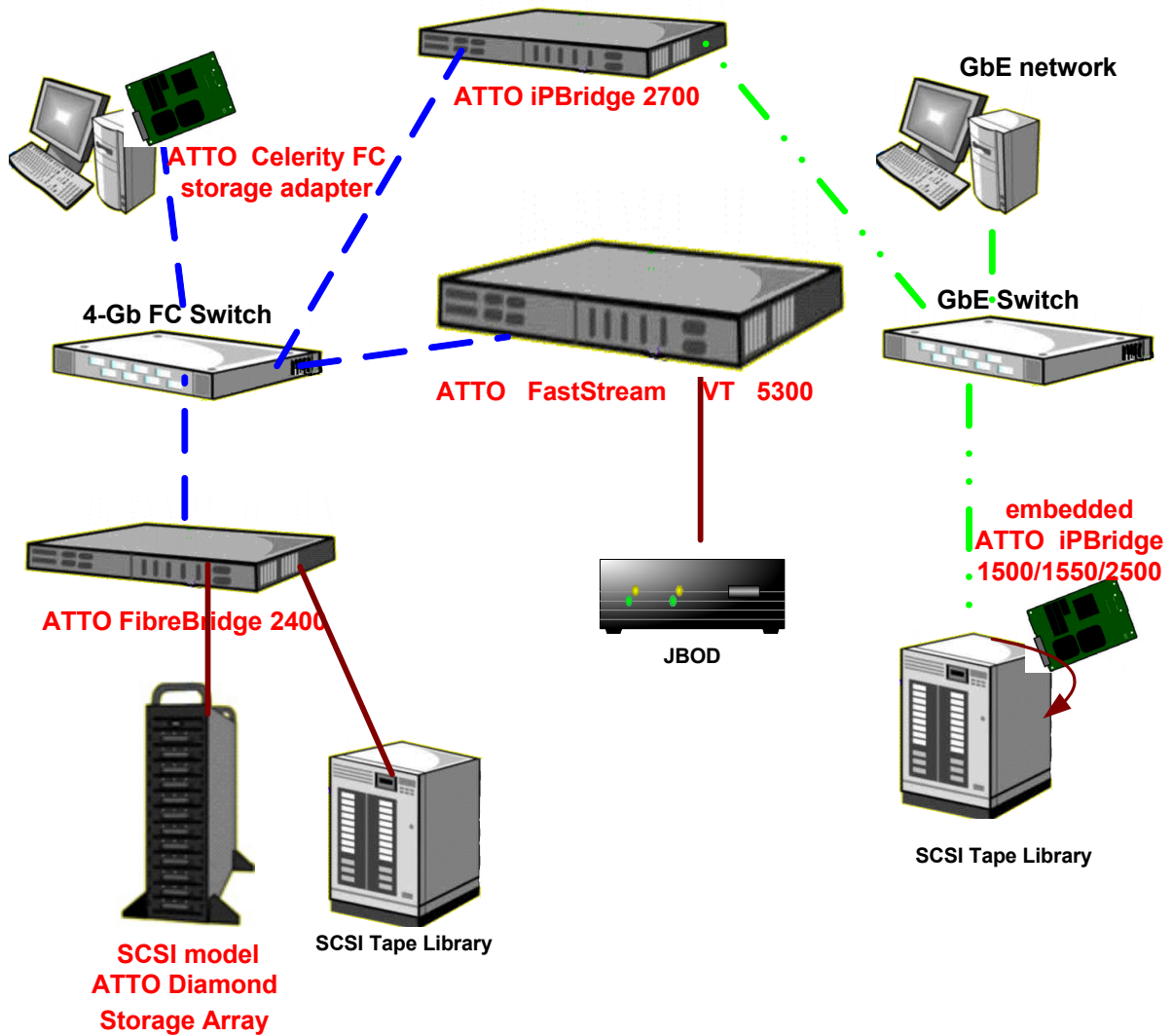

1.1 Physical attributes

The ATTO FastStream VT 5300 is a Fibre Channel to SCSI virtual tape appliance which can be seamlessly integrated into an existing storage environment.

The ATTO FastStream VT 5300 is available in an industry-standard 1U form factor for easy integration into racks. It supports next-generation media and, as a result, is equipped to handle the throughputs needed by advanced disk technologies.

Dimensions

Width: 17 inches

Length: 11 inches

Height: 1.7 inches (1U)

Weight: approximately 10 pounds

Cooling and airflow

Operating Temperature: 0-40° C external

Humidity: 10-90% non-condensing

Air enters from the front and is exhausted out the connector side by a blower inside the enclosure which provides 11 cubic feet per minute of airflow. Ambient air near the inlets should not exceed 40°C. The unit automatically stops operation if the temperature goes beyond this threshold.



CAUTION

Do not block the enclosure's vents. The FastStream VT 5300 shuts down if overheating occurs.

Power

The power supply circuit is permanently mounted within the enclosure and is not hot swappable. It has one standard IEC320 power receptacle and switch.

The universal power supply provides power for the FastStream VT 5300 board and cooling fan.

The power requirements of the ATTO FastStream VT 5300 plus the power draw of the other equipment in the rack must not overload the supply circuit and/or wiring of the rack.

Input voltage: 10/230V AC, with operating input range of 90-132V AC or 175-264V AC, 47-63Hz, single phase. The AC input range selection is automatic with no manual or jumper switchover required.

Power draw: 2 amps at 110V, 1.6 amps @ 90V

Fibre Channel port

The four independent 4-Gigabit Fibre Channel ports can connect the FastStream VT 5300 to either a Fabric or Arbitrated Loop.

- Full support for full duplex FC data transfers, FC-AL, PLDA and public loop login.
- Small Formfactor Pluggable (SFP) interface
- Auto negotiates with 1-, 2- and 4-Gb/sec. devices

SCSI ports

The two SCSI ports connect storage devices into the Fibre Channel Storage Area Network (SAN). Each port is totally independent from the other.

The ports are Ultra 320 SCSI busses with VHDCI connector, downward compatible with all forms of single-ended SCSI and all previous SCSI protocols.

Ethernet port

The 10/100 Base T Ethernet port is accessible from the RJ45 connector. Local diagnostics are supported through an integrated web server (ATTO FastStream VT 5300 browser-based user interface), CLI, Telnet and FTP. Includes support for DHCP, Telnet, FTP, SNMP and ICMP.

Serial port

The RS-232 serial port provides support for remote monitoring and management using a DB9 connector. The baud rate is programmable and preset at the factory to 115200 bps.

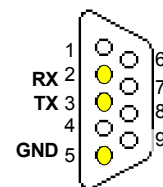

LED indicators

The LED indicators can be viewed from the connector side and the front side of the FastStream VT 5300. (See Exhibit 1.1)

LEDs on the connector side are:

A bicolor Ready/Fault LED lights green to indicate ready, lights yellow to show a faulted condition, and is off to indicate not ready.

Embedded in the Ethernet port connector: a lighted green LED shows a valid link; off indicates that no link is present. A separate blinking yellow LED indicates activity.

Fibre Channel port: A lighted green LED indicates link; off means no link. A separate green LED indicates activity if it is lit, no activity if it is off.

SCSI ports: A green LED on each port indicates activity if is lit.

LEDs on the faceplate are:

A bicolor Ready/Fault LED is lighted green to indicate ready, lighted yellow to show a faulted condition, and off indicates not ready.

SCSI ports: A green LED on each port indicates activity if is lit.

Fibre Channel port: bicolor LED indicates FC speed. If it is off, speed is 1-Gb; if it is green, 2-Gb, and yellow indicates 4-Gb FC. A separate green LED indicates activity if it is lit, no activity if it is off.

Exhibit 1.1-1 FastStream VT 5300 front panel LEDs.

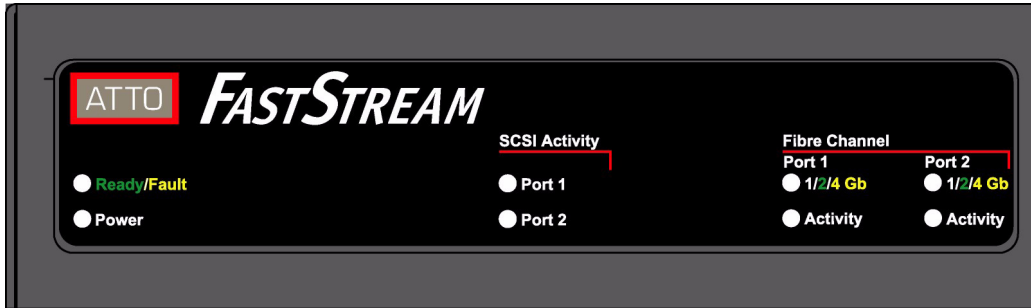
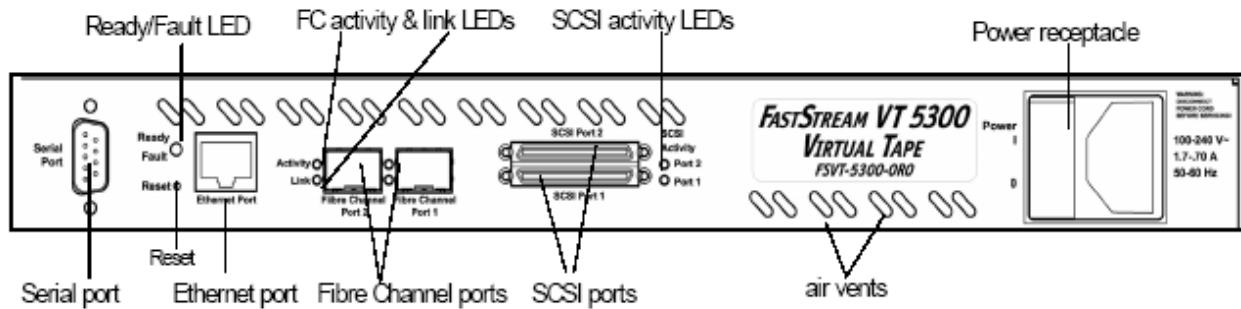

Exhibit 1.1-2 Connectors, LEDs and power receptacle



2.0 Installation

If you have not already completed the instructions on the *Quick Start* page packed with your FastStream VT 5300, use the following instructions to install the FastStream VT 5300.

Unpack the packing box; verify contents

- The FastStream. Note the serial number of your FastStream unit: _____
- Power cord
- “L” brackets for mounting in a 19” rack
- CD which includes the Firmware, Installation and Operation Manual, QuickNAV IP discovery program and system drivers

Install the FastStream

- 1 Place the FastStream VT 5300 on a stable flat surface or install it into a standard rack.
If installing into a rack,
 - a. Attach “L” brackets so that the front side with the LEDs face front and the connector side is at the back.
 - b. Install the FastStream horizontally within the rack so it does not reduce the air flow within the rack.
- 2 Connect the FastStream Fibre Channel ports to your SAN using SFPs and multimode fiber optic cables. Keep cable lengths as short as possible to ensure the highest signal quality and performance. For details, refer to [Cabling](#) on page i of the Appendix.
- 3 Connect SCSI storage devices to the FastStream SCSI ports. For details, refer to [Cabling](#) on page i of the Appendix.
- 4 Power up the SCSI devices
- 5 Connect the Ethernet port to your network. For details, refer to [Cabling](#) on page i of the Appendix.
- 6 Connect the AC power cord from the FastStream to the proper AC source outlet.
If you are using a rack:
 - a. Properly ground the FastStream to the rack equipment. The earth ground connection must be maintained.
 - b. The power requirements plus the power draw of the other equipment in the rack must not overload the supply circuit and/or wiring of the rack.
- 7 Use the power switch and switch on power to the FastStream

- 8 Wait up to two minutes for the FastStream Ready LED to light indicating the FastStream has completed its power-on self test sequence.
- 9 Windows® users continue to [Install Windows drivers](#) ; Mac® users continue to [Discover the IP address](#)

Install Windows drivers

- 1 Windows will automatically detect the FastStream 5300 and ask for the driver in the **Add Hardware** wizard. Select **Install from a list or specific location**
- 2 Click **Next**
- 3 Choose **Don't Search**
- 4 Click **Next**
- 5 Choose **Have disk**
- 6 The VT media changer and the VT tape have separate driver files. Repeat the following steps for each driver.
 - a. Specify the driver as found in the **VTMediaChanger** or **VTTapeDrive** folder in the setup CD. The files will be in a folder based on your operating system: Win2K drivers for Windows 2000 and Windows XP; Win2K3 drivers for all 2003 Server products.



Note

Use the files directly from the CD or copy them onto a floppy or to a local directory on your hard drive.

- b. Follow the remaining instructions to complete the installation procedure.
- 7 After the driver for each device is installed, the tape drive is listed under **Tape Drives** and the VT media changer is listed under **Media Changer** in the **System Devices** folder.

Discover the IP address

Before using QuickNav, the GUI which discovers the IP address automatically, ensure the following are in place:

- The host running QuickNav and the FastStream VT 5300 are on the same subnet.

- The switch(es) allows UDP broadcast messages to be passed through.
- A router is not placed between the host running QuickNav and the FastStream VT 5300.
- You have connected the FastStream VT 5300 and the network using at least Cat5e cabling.
- You have noted the FastStream VT 5300 serial number from the bottom of the unit.



Note

The FastStream VT 5300 is initially configured with DHCP enabled. It is best if you have access to a DHCP server.

- 1 Work from the computer attached to the FastStream VT 5300 Ethernet port on the same broadcast domain. From the CD supplied with your FastStream, run the QuickNav Utility **QuickNAV-windows.exe** for Windows or **QuickNAV-Mac** for Mac OS X.
- 2 Locate the FastStream with the serial number recorded earlier.
- 3 Highlight the serial number.
- 4 Click **Next**.

If a DHCP server is available on your network, an address is assigned automatically by the server. Note the assigned address:

If you do not have a DHCP server, get an IP address and subnet mask from your network administrator, type it into the area provided, and select **Next**.

- 5 Click on **Launch Browser**
Your browser points to the FastStream VT 5300 splash screen.

Begin initial configuration

- 1 The FastStream GUI welcome screen appears. Click on **Enter Here**
- 2 Type in the username and password.



Note

*The default username is **root**; it is case insensitive. The default password is **Password**; it is case sensitive. It is best practice to change the passwords. Refer to [Optional changes to system parameters](#) on page 11.*

- 3 The **Initial Setup** page appears.
Before creating a Virtual Tape Library, you may wish to initialize and verify your drives to ensure drive integrity. Refer to [Initialize and verify drives](#) on page 17.



CAUTION

Selecting Drive Initialization causes all previous storage data on the drive to be erased. Make sure all of your information is backed up before initializing drives.

- 4 Go on to [Configure Virtual Tape](#) on page 7.

Exhibit 2.0-1 General bracket assembly.

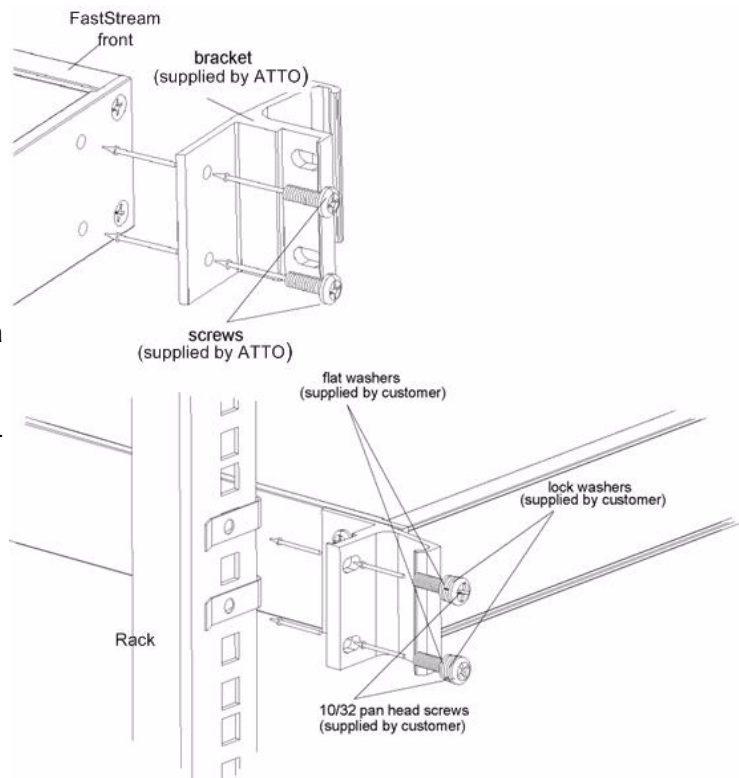

2.1 Configure Virtual Tape

The ATTO FastStream VT 5300 allows configuration of storage into a JBOD, RAID Level 0, RAID Level 1, RAID Level 10 or RAID Level 5 Virtual Tape Library (VTL). RAID is a storage configuration which uses multiple drives to increase capacity, performance and/or reliability.

The FastStream VT 5300 appears to hosts as a tape library, allowing ISV packages to issue a set of tape library commands to perform backup and restore operations to the FastStream.

The FastStream VT 5300 configures your storage into one or two Virtual Tape Libraries (VTL) depending on the choices you make using the FastStream GUI (refer to [Interface options](#) on page 23).

For every Virtual Tape Library created on the FastStream VT 5300, an underlying RAID Group is created from the selected drives to provide the physical storage medium for the virtual tape cartridges.

You may either use the **Quick Configuration** or **Custom Initial Setup**.

- **Quick Configuration:** quickly generates a Virtual Tape Library after you answer a few key questions. The procedure uses all attached SCSI disks to build a single VTL. If you want to initially create more than one VTL, use custom setup. You may modify this configuration after initial setup.
- **Custom Setup:** allows you to configure the FastStream VT 5300 to best suit the needs, performance and level of reliability for your application. If you want to initially create more than one VTL, use custom setup.

Whichever method you choose, you may change the configuration later. However, changing configuration erases data and may affect performance. Backup all previously stored data

and plan carefully if you choose to use the custom setup procedure.

Explanations of many aspects of the FastStream VT 5300 operation are displayed when choices are made in the FastStream GUI. Read all information and warnings.



CAUTION

Selecting Commit during configuration causes all previous storage data on the drive to be erased. Make sure all of your information is backed up.

Before beginning these procedures you may want to ensure drives are reliable by initializing and verifying the drives in your system as outlined in [Initialize and verify drives](#) on page 17.



CAUTION

Selecting Drive Initialization causes all previous storage data on the drive to be erased. Make sure all of your information is backed up before initializing drives.

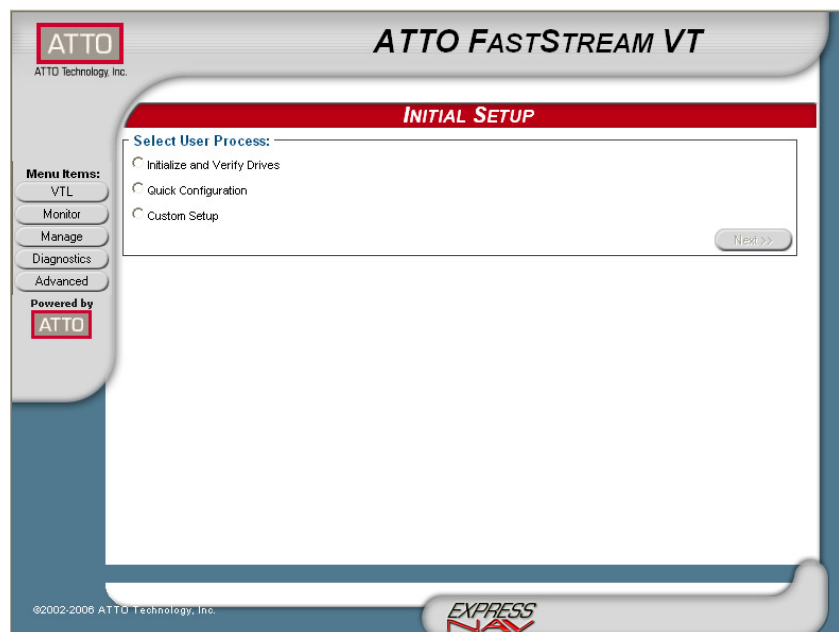

Use quick initial configuration

Quick Configuration quickly generates a Virtual Tape Library after you answer a few key questions. The procedure uses all attached SCSI disks to build a single VTL. If you want to initially create more than one VTL, use custom setup. You may modify this configuration after initial setup.

- 1 If you are not already in the FastStream GUI, type the IP address of your appliance, as found in [Use the FastStream VT 5300 GUI](#) on page 23, in a standard browser, click **Enter Here** and type in your username and password.
- 2 From the **Initial Setup** page, choose **Quick Configuration**.
The FastStream scans your system for devices; the **Quick Configuration** page appears displaying the number of devices discovered and the total capacity of those devices.
- 3 Type in a name for your Virtual Tape Library. Names may be up to 14 characters and may not contain any spaces.

- 4 Answer the questions in **Step 2** based on the needs of your software vendor.
 - If your devices are RAID protected, the FastStream does not reconfigure them and you do not need to answer the next question. If they are not, the FastStream sets the RAID level depending on your answer to the next question.
 - If you choose **Throughput**, you must have at least two devices, or three devices if you want a Hot Spare drive. If you choose **Capacity**, you must have three devices, or four devices if you want a Hot Spare drive.
 - Select the number of simultaneous backups you wish to run, from 1 to 30.
 - Click in the box if you want a Hot Spare (refer to [Use Hot Spare devices](#) on page 9.)
- 5 Select **Next**
- 6 Verify you want to continue: click **Yes**.
- 7 The **Monitor VTL** page appears showing a single VTL has been created using all discovered SCSI devices.

Use custom initial setup

Custom Setup allows you to configure the FastStream VT 5300 to best suit the needs, performance and level of reliability for your application. If you want to initially create more than one VTL, use custom setup.

- 1 If you are not already in the FastStream GUI, type the IP address of your appliance, as found in [Use the FastStream VT 5300 GUI](#) on page 23, in a standard browser, click **Enter Here** and type in your username and password.
- 2 On the **Initial Setup** page, choose the **Custom Setup** button.
- 3 Click on **Next**.
- 4 Type a name for your Virtual Tape Library in the box provided on the page under the **Step 1** heading.
 - In **Step 2**, select a RAID level. Refer to [Designing RAID groups](#) on page iii in the Appendix for more information. Click on the Hot Spares radio button if you want a Hot Spare. Refer to [Use Hot Spare devices](#) on page 9.
- 5 Click on the **System Scan** button to discover the drives available for VTL configuration.

- 6 When the scanned drives box is populated, select the drives to be used for the underlying RAID Group associated with the VTL.
- 7 Click **Next**.
- 8 Answer the questions in **Step 4** to define your virtual storage as if it were a physical tape storage array based on the needs of your ISV.
 - Enter the number of tape drives (max. 30) and number of tape cartridges (max. 256). You cannot continue unless you fill in these two parameters.
 - The tape bar code prefix is entered automatically, but you may change it here, specifying the first four to six alpha-numeric characters of a tape bar code used by tape backup software. The remaining characters are entered by the system automatically to provide a unique identity for each virtual tape.
 - Choose LTO or DLT media type
 - The **Media Changer Vendor ID, Media Changer Product ID, Media Changer Revision, Tape Drive Vendor ID, Tape Drive Product ID** and **Tape Drive Revision**

are filled in automatically by the FastStream but you may change these parameters if you wish.

9 Click **Next**.

10 The **Virtual Tape Library Setup** page appears. If the new configuration is the way you want it, click on **Commit**.

If you wish to change anything, click on **Cancel**. Return to the **Monitor VTL** page by clicking on the **VTL** menu item on the left-hand side of the page, and begin this procedure again.

11 In the warning box, verify that you want to add the VTL by clicking on **Yes**. Clicking on **No** ends the procedure without making a change.

12 The **VTL Setup** page appears.

- Click on **Done** if you do not want to create another VTL. The **Monitor VTL** page appears.
- Click on **Configure Another** to create another VTL. The **Virtual Tape Library Setup** page appears.

Use Hot Spare devices

If a member of a virtual device becomes degraded or faulted, you lose some redundancy in your VTL until a new member is rebuilt into the VTL. However, Hot Spare devices may be designated as replacements for faulted devices without intervention by you or a host.



Note

JBOD and RAID Level 0 groups do not provide redundancy, making Hot Spare devices unnecessary.

The ATTO FastStream VT 5300 replaces degraded or faulted virtual devices in VTL without intervention by you or a host if you set up a pool of Hot Spare devices of different sizes appropriate for your VTL.



Note

Block devices in the Hot Spare pool should be of appropriate size to the RAID Group so that smaller block devices are not replaced by much larger Hot Spare devices.

When the ATTO FastStream VT 5300 detects a faulted device, the Controller searches the Hot Spare pool for the smallest block device of sufficient size to substitute for the faulted drive. The FastStream VT 5300 replaces the faulted device with the device from the Hot Spare pool.

The FastStream VT 5300 begins an automatic rebuild of the VTL.



Note

Hot Spares may be set up by the FastStream VT 5300 automatically depending on your choices during initial setup.

- 1 If you are not already in the FastStream GUI, type the IP address of your appliance, as found in [Use the FastStream VT 5300 GUI](#) on page 23, in a standard browser, click **Enter Here** and type in your username and password.
- 2 The **Monitor VTL** page appears. On the left hand side menu, click on **Manage**.
- 3 On the splash page, click on the **FastStream** arrow.
- 4 Click on the **Add/Remove Hot Spares** button
- 5 Click on **Next**.
- 6 The **Add/Remove Hot Spares** page appears. Follow the on-screen directions. When you complete your changes, click on **Commit**.

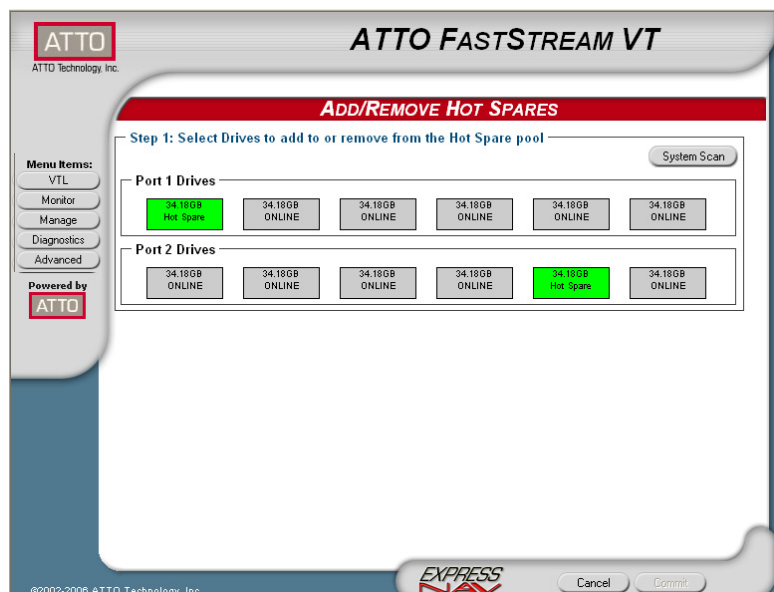

Secure data through Write Protection

For added security, write protection can be enabled for any tape cartridge with a VTL. When write protection is enabled, existing data on the tape cartridge cannot be overwritten or erased.

The displayed data can be sorted by any field by clicking on the heading for the field; clicking twice reverses the sort order.

- 1 If you are not already in the FastStream GUI, type the IP address of your appliance, as found in [Use the FastStream VT 5300 GUI](#) on page 23, in a standard browser, click **Enter Here** and type in your username and password.
- 2 The **Monitor VTL** page appears. On the menu at the left hand side of the page, choose **Manage**.
- 3 The **Manage VTL** page appears. Choose the **Virtual Tape Libraries** arrow.

- 4 Click in the **Enable/Disable Write Protection** button.
- 5 Click on **Next**.
- 6 Click on the tab with the name of the VTL for which you wish to change write protection.
- 7 Click in the radio box to change the write protection level for that VTL.
- 8 Click **Commit**.
- 9 A warning box appears. If you wish to proceed, click on **Yes**. Clicking on **No** ends the procedure without making a change.
- 10 The **Enable/Disable Write Protection** page appears.
- 11 If you wish to protect elements in another library, select the library and repeat this procedure.

Move Virtual Tape Cartridges

The **Move Medium** page is an interface which simulates a generic library front panel operation.

- 1 If you are not already in the FastStream GUI, type the IP address of your appliance, as found in [Use the FastStream VT 5300 GUI](#) on page 23, in a standard browser, click **Enter Here** and type in your username and password.
- 2 The **Monitor VTL** page appears. On the menu at the left hand side of the page, choose **Manage**.
- 3 The **Manage VTL** page appears. Choose the **Virtual Tape Libraries** arrow.
- 4 Click in the **Move Medium** button.
- 5 Click on **Next**.
- 6 Click on the tab with the name of the VTL for which you wish to move medium.
- 7 Click on the radio button next to the Virtual Tape Cartridge element you wish to move.

- 8 Click on the radio button next to the new place where you want the Virtual Tape Cartridge element.
- 9 Click **Commit**.
- 10 The **Monitor VTL** page appears.
- 11 If you wish to move other VTL cartridges elements, repeat this procedure.

ATTO FASTSTREAM VT

MOVE MEDIUM

STEP 3: PRESS RESET, COMMIT, OR CANCEL BUTTON

Barb1

Contents	LU/ID Element	Element Type	Capacity (GB)	% Write Full Protect
empty	1 0 000	Medium Transport	0	- -
empty	1 1 260	Data Transfer	0	- -
ATTOVT677a0000	- 004	Storage	6.82GB	1% enabled
ATTOVT677a0001	- 005	Storage	6.82GB	1% disabled
ATTOVT677a0002	- 006	Storage	6.82GB	1% enabled
ATTOVT677a0003	- 007	Storage	6.82GB	1% disabled
ATTOVT677a0004	- 008	Storage	6.82GB	1% disabled
empty	- 009	Storage	0	- -
empty	- 010	Storage	0	- -
empty	- 011	Storage	0	- -
empty	- 012	Storage	0	- -

©2002-2006 ATTO Technology, Inc. EXPRESS Reset Cancel Commit

2.2 Optional changes to system parameters

Default values are appropriate for most configurations, but may be modified for your needs using ATTO FastStream VT 5300 browser-based user interface.

Customize the username, password

It is best practice to change the default username and password to a username and password significant to you.

While opening a Command Line Interface session is not usually recommended, you must use the CLI to change the username and password.



Note

The username is case insensitive and password is case sensitive.

- 1 Open a CLI session either using Telnet or the serial port as shown in [Interface options](#) on page 23.
 - 2 Type **set Username [user name]**
 - 3 Press **Enter**.
 - 4 Type **set Password**
 - 5 Press **Enter**.
 - 6 Follow the instructions on the screen to confirm your old and new password.
- The username and password for all Telnet, FTP and ATTO FastStream VT 5300 browser-based user interface sessions is changed.

Change system configurations

You may change several parameters using the **System Configuration** page of the FastStream GUI.

- 1 If you are not already in the FastStream GUI, type the IP address of your appliance, as found in [Use the FastStream VT 5300 GUI](#) on page 23, in a standard browser, click **Enter Here** and type in your username and password.
 - 2 The **Monitor VTL** page appears. In the left-hand menu, click on the **Manage** button.
 - 3 In the main splash screen, click on the **FastStream** menu item.
 - 4 Click on the **System Configuration** button
 - 5 Click on **Next**.
 - 6 Click on the choices available. A choice may be greyed out because it is not available based on a previous choice.
- **Enable or disable Simple Network Time Protocol.**

Enabling SNTP means the FastStream sets its time and date based on the information supplied by a server on the World Wide Web. If you disable SNTP, you set the time and date yourself in the text boxes.
 - **Change the Fibre Channel configuration for each port**
 - **Data rate**

Specifies the SCSI initiator ID on the specified SCSI port as found in NVRAM. All maps coinciding with the ID are destroyed

Specifies the rate the FastStream VT 5300 uses 1 Gigabit/sec., 2 Gigabit/sec. 4 Gigabit/sec. or auto negotiate. The default is auto.

- **Connection mode**

Controls the connection mode the FastStream VT 5300 uses when communicating across a FC network, either to an arbitrated loop (FC-AL) when you select **loop** mode, or point-to-point when you choose **ptp**. If you choose **loop-ptp** or **ptp-loop**, the FastStream VT 5300 tries to use the first parameter first, but uses the second if it cannot use the first. The default is loop
 - **Enable or disable hard address assignment**

Under soft addressing, the FastStream VT 5300 loop address is assigned during loop initialization. Enter the hard address if you enable hard addressing: a hexadecimal value representing the address the FastStream VT 5300 tries to use. Choices are 0 through 125 and default is fp1=3; fp2=4
 - **Change the SCSI configuration for each port**
 - **Bus speed**

Controls the transfer rate at which the unit attempts to negotiate with its SCSI devices. Default is Ultra 320
 - **Initiator ID**

after the command is issued. Default is 7
- 7 When you have completed your changes, click on **Commit**.

Exhibit 2.2-1 System Configuration page

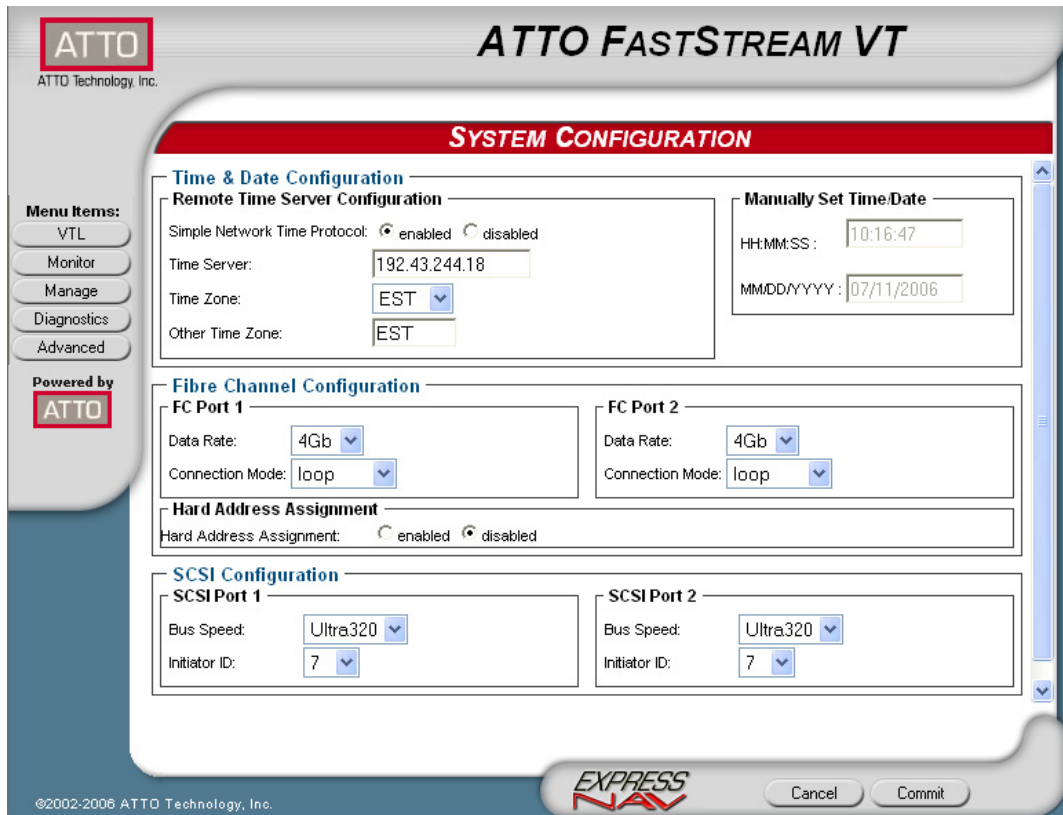

Advanced CLI page

Changes to other parameters may be made using the **Advanced** page.



CAUTION

Do not use this page unless you are directed to by an ATTO technician.

Changing parameters may cause loss of data and/or disruption to performance and reliability of the FastStream.

The FastStream GUI is the preferred method to manage the FastStream.

- 1 If you are not already in the FastStream GUI, type the IP address of your appliance, as found in [Use the FastStream VT 5300 GUI](#) on page 23, in a standard browser, click **Enter Here** and type in your username and password.

- 2 The **Monitor VTL** page appears. In the left-hand menu, click on the **Advanced** menu item on the left side of the screen.
- 3 The **Advanced CLI Configuration** page appears. Wait for the **Ready** prompt, then type in the CLI command in the text box provided. Refer to [CLI provides an ASCII-based interface](#) on page v of the Appendix.
- 4 Click the **Submit** button: this is equivalent to typing in the CLI command into a telnet or serial port CLI session.

A text field beneath the box lists the most recent commands issued to the FastStream through this page. If you enter an incorrect parameter, the CLI help text is displayed, showing the parameters available. An asterisk next to the **Ready** prompt indicates you must type **SaveConfiguration restart** in the text box for changes to take effect.

3.0 Monitor storage and diagnose configurations

You may determine the performance of drives attached to the FastStream VT 5300 using various displays and tests in the FastStream GUI.

The following instructions assume you have already set up at least one Virtual Tape Library. Refer to [Configure Virtual Tape](#) on page 7.

The ATTO FastStream VT 5300 collects various metrics to measure performance for physical drives attached to the FastStream during normal system operation and drive initialization and verification.



CAUTION

New performance data is updated every 60 seconds which impacts performance slightly, even if you minimize the browser window. Exit the browser GUI completely whenever you need maximum performance.

Monitor VTL page

The **Monitor VTL** page is the first page you see when you open the FastStream GUI after setting up at least one VTL.

Each VTL has its own tab. Information displayed includes RAID Level, RAID status, capacity, the Fibre Port and LUN to which the VTL is mapped,

the element, element type and contents and the percentage of capacity used.

To get further information or to manage the VTL, click on the menu items on the left-hand side of the screen. To return to this screen, click on **VTL**.

ATTO
ATTO Technology, Inc.

ATTO FASTSTREAM VT

MONITOR VTL

VTL1 VTL2

Menu Items:
VTL
Monitor
Manage
Diagnostics
Advanced
Powered by **ATTO**

System Status

RAID Level	RAID Status	Capacity (GB)	% Full
RAID1	ONLINE	8.49GB	0%

Capacity of each tape: 2.12GB

Element Status

FP/LUN	Element	Element Type	Contents	% Full
1 0	0	Medium Transport		
1 1	260	Data Transfer		
1 2	261	Data Transfer		
	4	Data Storage	ATTOV Taab10000	0%
	5	Data Storage	ATTOV Taab10001	0%
	6	Data Storage	ATTOV Taab10002	0%
	7	Data Storage	ATTOV Taab10003	0%
	8	Data Storage		
	9	Data Storage		
	10	Data Storage		

©2002-2008 ATTO Technology, Inc. **EXPRESS** **NAV**

Health and Status Monitor page

- 1 If you are not already in the FastStream GUI, type the IP address of your appliance, as found in [Use the FastStream VT 5300 GUI](#) on page 23, in a standard browser, click **Enter Here** and type in your username and password.
- 2 The **Monitor VTL** page appears. On the menu at the left hand side of the page, click on **Diagnostics**.
- 3 The **Health and Status Monitor** page appears. If you click **Details**, added information about each parameter appears on the **Configuration Display** page (refer to [Configuration Display page](#) below).

- **RAID Groups**
RAID Group names, RAID status, available Hot Spares and number of faulted drives
- **Environmental Status**
Temperature and voltage
- **Interface Status**
Ethernet management port link status and Fibre Channel port link, speed and connection mode
- Drive status by port
Size and status

Configuration Display page

Clicking on **Details** in the **Health and Status Monitor** page (refer to details above) gives you added information about each parameter on the **Configuration Display** page. You may view the details of any parameter from this page.

- **RAID Groups**
RAID Group names, RAID status, available Hot Spares, number of faulted drives, RAID Level, Interleave and total capacity of each RAID Group.

- **Drives**
Drive Configuration by port, including drive size and status
- **Interfaces**
Ethernet management port link status and Fibre Channel port link, speed, connection mode, Node Name and Port Name.



Note

*At any point, if you do not want to continue before you click **Commit**, click on the **Cancel** button to return to the previous setup menu.*

Phone home: E-mail messages

E-mail notification allows the FastStream VT 5300 to send an E-mail message to you, a network administrator or other users when certain events occur with the FastStream. Serious error messages are sent immediately, while messages for less serious errors are sent every 15 minutes.

- **Types of errors**
 - SCSI device errors such as medium error, aborted command and hard error
 - Device transitions from online to offline
 - Critical and warning temperature conditions
 - Critical and warning voltage conditions
 - Power recycle/power failure conditions
- **Warning messages**
 - device down
 - medium error

- abort command
- **Warning levels**
 - **All:** warnings, critical events and informational messages are sent
 - **Critical:** critical event E-mails are sent
 - **Warning:** warnings and critical event E-mails are sent
 - **None:** no E-mails are sent

You may send E-mails to up to five E-mail addresses and designate which conditions prompt each E-mail notification.

For example, a recipient with a critical severity level only receives critical messages and not warning or informational messages.

When an event occurs that warrants E-mail notification, the FastStream VT 5300 sends the

message; it cannot respond to a rejection by a server for an invalid address. Ensure all E-mail addresses typed in are valid.

Each E-mail is time stamped when it leaves as part of the SMTP header information as shown in Exhibit 3.0-1.

- 1 If you are not already in the FastStream GUI, type the IP address of your appliance, as found in [Use the FastStream VT 5300 GUI](#) on page 23, in a standard browser, click **Enter Here** and type in your username and password.
- 2 The **Monitor VTL** page appears. On the menu at the left hand side of the page, choose **Manage**.
- 3 The **Manage VTL** page appears. Click on the **FastStream** arrow.
- 4 Click the **Set up Error Notification** button
- 5 Click **Next**.
- 6 Click on the **Enabled** button for **Notification Configuration**
- 7 Type in the sender address (E-mails show this name in the **From** field)
- 8 Type in the SMTP Server IP Address
- 9 Type in the Username and Password of your SMTP E-mail account
- 10 Type in up to five E-mail addresses
- 11 Choose **All**, **Critical** or **Warning** for each E-mail address.
- 12 When all information is typed in, click **Commit**.
- 13 Your settings are displayed. You may change or disable E-mail notification at any time from the **Error Notification** page.

Exhibit 3.0-1 The E-mail messages sent by the FastStream VT 5300 follow this format.

```
Subject: [The Type of Event that Occurred]

Message Body:

This is a status message from [FastStream name]. Identifying information as well as the most recent entries from the event log appear below.
***** Unit Information *****
Serial Number : [Serial Number]
IP Addresses:  [IP Address1]
               [IP Address2]
***** Event Log Entries *****
[Listing of the ten latest event log entries]
```

Measure drive performance



CAUTION

New performance data is updated every 60 seconds which impacts performance slightly, even if you minimize the browser window. Exit the browser GUI completely whenever you need maximum performance.

The FastStream VT 5300 collects various metrics to measure performance for physical drives attached to the FastStream during normal system operation and drive initialization and verification.

- 1 If you are not already in the FastStream GUI, type the IP address of your appliance, as found in [Use the FastStream VT 5300 GUI](#) on page 23, in a standard browser, click **Enter Here** and type in your username and password.
- 2 The **Monitor VTL** page appears. On the menu at the left hand side of the page, click on **Diagnostics**.
- 3 The **Diagnostics Menu** page appears. Select **Drive Performance and Health**.
- 4 Click **Next**.
- 5 The **Drive Performance and Health** page appears. Click on a drive in the drive section.
- 6 Click **Start**.
- 7 Drive performance is displayed under the **Drive Metrics** section of the page.

Scan drive surfaces

The read only test performs a non-destructive scan over the entire surface of each drive to identify bad areas of the disk drives and determine read performance. It may be run while data is passing through the FastStream.

Running this test may negatively impact performance. Once the Read-only test has completed, system operation returns to normal.

- 1 If you are not already in the FastStream GUI, type the IP address of your appliance, as found in [Use the FastStream VT 5300 GUI](#) on page 23, in a standard browser, click **Enter Here** and type in your username and password.
- 2 The **Monitor VTL** page appears. On the menu at the left hand side of the page, click on **Diagnostics**.
- 3 The **Diagnostics Menu** page appears.
- 4 Click the **Read-Only Drive** test button
- 5 Click **Next**

- 6 Choose the drives you wish to test
- 7 Click **Commit**
- 8 A warning message displays; choose **yes** to continue.
- 9 The **Drive Performance and Health** screen appears with the **Drive Metrics** box displaying basic information about the drives. Click on the **Show Help Text and Drives** arrow.
- 10 If a drive is being read, its display shows the percentage of progress. When the test is complete, click on each drive to see its information highlighted in the **Drive Metrics** window.



Note

*If you close the browser or navigate away from this page, you may re-access these results by clicking the **Diagnostics** button and choosing the **Drive Performance and Health** option. Results are available until the FastStream is restarted.*

Verify storage

Verify the status of attached storage to identify drive issues after drives have been initialized. If the verify operation detects an error, the FastStream tries to re initialize the drive, erasing information stored on the drive. Be sure to back up data before performing verification.



CAUTION

Data may be erased during this process. Back up your data before selecting Commit.

These operations have a negative impact on the performance of normal operations; all activity should be stopped.

- 1 If you are not already in the FastStream GUI, type the IP address of your appliance, as found in [Use the FastStream VT 5300 GUI](#) on page 23, in a standard browser, click **Enter Here** and type in your username and password.
- 2 The **Monitor VTL** page appears. On the menu at the left hand side of the page, click on **Diagnostics**.
- 3 The **Diagnostics Menu** page appears.
- 4 Click the **Initialize and Verify** button
- 5 Click **Next**
- 6 Click on the drives you wish to test; the drives are highlighted.
- 7 Select **Verify Only**
- 8 Click **Commit**
- 9 A warning message displays; choose **yes** to continue.
- 10 The **Drive Performance and Health** screen appears
- 11 The **Time Remaining** box tells you how much time remains until the verification process is complete. The representation of each drive in the **Drives** box shows the percentage of verification completed.

4.0 Modify storage

Use the FastStream GUI to replace a failed drive, add new drives or redesign VTL configurations.

The FastStream GUI takes you step by step through many procedures which allow you to modify your storage and VTL. Read all notes and cautions carefully as you go to ensure the best performance and use of your storage.

For every Virtual Tape Library created on the FastStream VT 5300, an underlying RAID Group is created from the selected drives to provide the physical storage medium for the virtual tape cartridges.

Initialize and verify drives

When you initially set up the FastStream, replace a failed drive or add new drives to the FastStream, perform drive initialization and verification to ensure the integrity of these drives.

When the drives are selected, the ATTO FastStream VT 5300 writes a pattern to the entire drive; the drives may then be read back and verified for integrity to fix soft errors and reallocate bad blocks on your existing drives.



CAUTION

Selecting Drive Initialization causes all previous storage data on the drive to be erased. Make sure all of your information is backed up before initializing drives.

- 1 If you are not already in the FastStream GUI, type the IP address of your appliance, as found

in [Use the FastStream VT 5300 GUI](#) on page 23, in a standard browser, click **Enter Here** and type in your username and password.

- 2 Select **Initialize and Verify Drives**
- 3 Click **Next**
- 4 Select **Initialize and Verify**
- 5 All eligible drives are highlighted in green; the system only initializes highlighted drives. Ensure only the drives you are initializing are selected. Click **Commit**



Note

Do not restart the FastStream or disconnect or power cycle drives during Drive Initialization and Verification or you must start the verification process from the beginning.

Add drives to a RAID Group

If you have unallocated drives, you can increase the number of drives used by an existing VTL by adding an unallocated drive to the VTL's RAID Group. The increased capacity of the RAID Group will be seen as an additional Virtual Tape cartridge in the library. You may have to add more than one drive.

- 1 Initialize and verify your new storage as outlined in [Initialize and verify drives](#) above.
- 2 Click on the **Manage** button
- 3 Select the **RAID Groups** drop down arrow.
- 4 Click on **Add Drives to a RAID Group**
- 5 Click on **Next**
- 6 Select the RAID Group associated with the VTL you wish to add the drives to from the drop down menu.

- 7 Click on the drives you wish to add to the RAID Group.



CAUTION

Adding drives to an existing RAID Group may adversely impact performance. You cannot reverse this operation unless you delete the RAID Group.

- 8 When you have completed your changes, click on **Commit**
- 9 In the warning box, verify that you want to add the drives to the RAID Group by clicking on **Yes**. Clicking on **No** ends the procedure without making a change.
- 10 The **Health and Status Monitor** page appears.

Rebuild RAID Groups

If you receive an E-mail notification from the FastStream VT 5300 as set up previously using the Phone Home error notification (refer to [Configuration Display page](#) on page 14) or otherwise realize a VTL's RAID Group has been compromised because of a failed drive, you need to rebuild the VTL's associated RAID Group.

- 1 If you are not already in the FastStream GUI, type the IP address of your appliance, as found in [Discover the IP address](#) on page 5, in a standard browser, click **Enter Here** and type in your username and password.
- 2 The **Health and Status Monitor** page appears showing the status of each drive connected to the FastStream VT 5300. Click on the **Diagnostics** button on the left side under **Menu Items**.
- 3 Click on **Identify Drive** under **Select Diagnostic**
- 4 Click **Next**
- 5 Click on the degraded drive.
- 6 Click **Commit**
- 7 The LED on the degraded drive flashes.



Note

*The status of a drive which cannot be accessed is displayed as **Unavailable**. To identify this drive, observe the access lights for all drives in the RAID Group during disk access: if the LED is not flashing on a drive, it is the unavailable drive.*

- 8 When you have identified the failed drive, select the drive in the **Identify Drive** box to stop the LED flash.



Note

It is best practice to stop drive activity while changing drives.

- 9 Remove the failed drive from the array.
- 10 Insert the new drive into the array.
- 11 In the FastStream GUI, click the **Manage** button.
- 12 Click the arrow next to **RAID Groups**.
- 13 Select **Rebuild RAID Groups**.
- 14 Click **Next**.
- 15 At the **Step 1: Select a RAID group**, select **Degraded Drives** from the drop down menu.
- 16 Degraded drives are listed under **Step 2: select a RAID group member**. Click on the degraded drive to rebuild. The graphic changes color.
- 17 Under **Step 3: select a replacement drive**, select the new drive. The graphic changes color.
- 18 Click **Commit**
- 19 In the warning box, verify that you want to rebuild the RAID Group by clicking on **Yes**. Clicking on **No** ends the procedure without making a change.
- 20 When the procedure is complete, the **RAID Group Rebuild** page appears.

Add or remove Hot Spares

For an explanation of Hot Spares, refer to [Use Hot Spare devices](#) on page 9.

- 1 If you are not already in the FastStream GUI, type the IP address of your appliance, as found in [Use the FastStream VT 5300 GUI](#) on page 23, in a standard browser, click **Enter Here** and type in your username and password.
- 2 Click on the **Manage** button.
- 3 Click on the **FastStream** drop down arrow.
- 4 Select the **Add/Remove Hot Spares** button.

- 5 Click **Next**
- 6 Select the drive(s) you want to add or remove from the Hot Spare pool.
- 7 When you have completed your changes, click **Commit**.
- 8 In the warning box, verify that you want to add or remove the Hot Spare by clicking on **Yes**. Clicking on **No** ends the procedure without making a change.
- 9 When the process is complete the **Health and Status Monitor** page appears.

Add a VTL from another FastStream VTL

If you want one FastStream VT 5300 to recognize a library from another FastStream device, the FastStream VT 5300 must discover it through mapping. When you created your first library, the media changer and tape drive LUNs are mapped automatically to one of two ports. A second library is mapped to the other port.



Note

The FastStream VT 5300 supports two libraries, one on each port.

- 1 If you are not already in the FastStream GUI, type the IP address of your appliance, as found

in [Use the FastStream VT 5300 GUI](#) on page 23, in a standard browser, click **Enter Here** and type in your username and password.

- 2 Click on the **Advanced** button.
- 3 In the text box provided type **AutoMap**.
- 4 Click on **Submit**.
- 5 When **Ready*** is displayed in the screen below, type **SaveConfiguration**.
- 6 Click on **Submit**.
- 7 Click on the **VTL** menu item on the left hand side of the screen.
- 8 The **Monitor VTL** page appears. A tab for the library you just added is displayed.

Delete a VTL

- 1 If you are not already in the FastStream GUI, type the IP address of your appliance, as found in [Use the FastStream VT 5300 GUI](#) on page 23, in a standard browser, click **Enter Here** and type in your username and password.
- 2 The **Monitor VTL** page appears. On the menu at the left hand side of the page, choose **Manage**.
- 3 The **Manage VTL** page appears. Choose the **Virtual Tape Libraries** arrow.
- 4 Click in the **Delete Virtual Tape Library** button.

- 5 Click on **Next**.
- 6 Click on radio box displaying the name of library.
- 7 Click **Commit**
- 8 In the warning box, verify that you want to delete the VTL by clicking on **Yes**. Clicking on **No** ends the procedure without making a change.
- 9 After the process completes, the **VTL Monitor** page appears

Secure data through Write Protection

For added security, write protection can be enabled for any tape cartridge with a VTL. When write protection is enabled, existing data on the tape cartridge cannot be overwritten or erased.

The displayed data can be sorted by any field by clicking on the heading for the field; clicking twice reverses the sort order.

- 1 If you are not already in the FastStream GUI, type the IP address of your appliance, as found in [Use the FastStream VT 5300 GUI](#) on page 23, in a standard browser, click **Enter Here** and type in your username and password.
- 2 The **Monitor VTL** page appears. On the menu at the left hand side of the page, choose **Manage**.
- 3 The **Manage VTL** page appears. Choose the **Virtual Tape Libraries** arrow.

- 4 Click in the **Enable/Disable Write Protection** button.
- 5 Click on **Next**.
- 6 Click on the tab with the name of the VTL for which you wish to change write protection.
- 7 Click in the radio box to change the write protection level for that VTL.
- 8 Click **Commit**.
- 9 A warning box appears. If you wish to proceed, click on **Yes**. Clicking on **No** ends the procedure without making a change.
- 10 The **Enable/Disable Write Protection** page appears.
If you wish to protect elements in another library, select the library and repeat this procedure.

Move Virtual Tape Cartridges

The **Move Medium** page is an interface which simulates a generic library front panel operation.

- 1 If you are not already in the FastStream GUI, type the IP address of your appliance, as found in [Use the FastStream VT 5300 GUI](#) on page 23, in a standard browser, click **Enter Here** and type in your username and password.
- 2 The **Monitor VTL** page appears. On the menu at the left hand side of the page, choose **Manage**.
- 3 The **Manage VTL** page appears. Choose the **Virtual Tape Libraries** arrow.
- 4 Click in the **Move Medium** button.
- 5 Click on **Next**.
- 6 Click on the tab with the name of the Virtual Tape Cartridge for which you wish to move medium.
- 7 Click on the radio button next to the Virtual Tape Cartridge element you wish to move.
- 8 Click on the radio button next to the new place where you want the Virtual Tape Cartridge element.
- 9 Click **Commit**.
- 10 The **Monitor VTL** page appears.
- 11 If you wish to move other VTL cartridge elements, repeat this procedure.

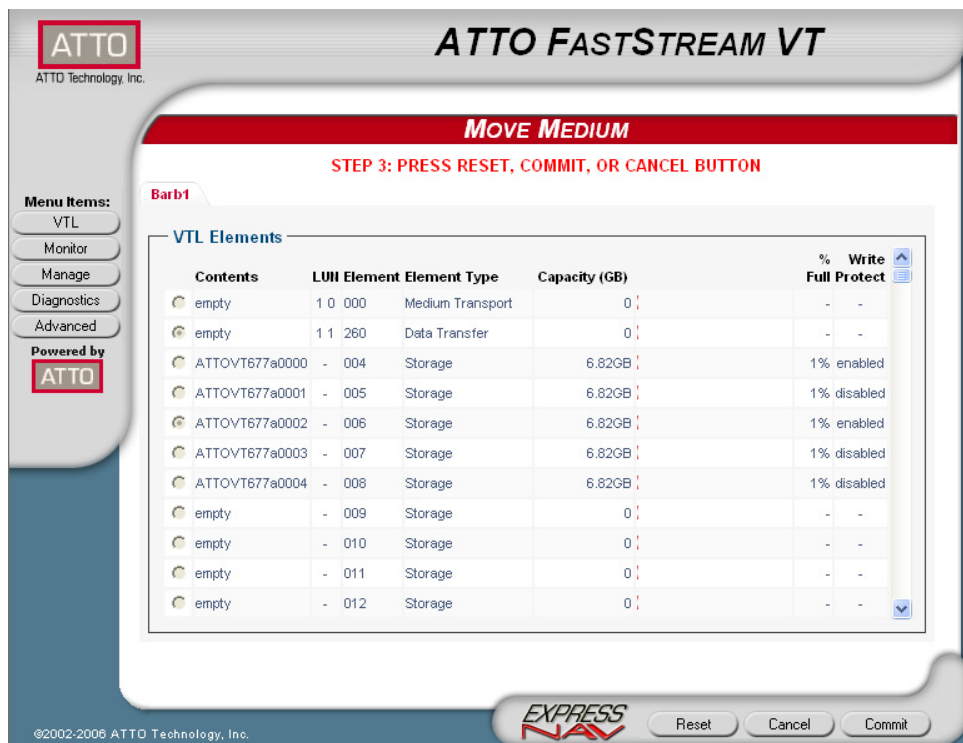

5.0 Update storage and firmware

You can update the ATTO FastStream VT 5300 at any time. Refer to www.attotech.com for complete information.

Several methods are available to update the ATTO FastStream firmware and to re-initialize attached storage. Be sure all data is backed up

before using any of these procedures to prevent data loss.

Remove stale VTL configuration data

Initializing the attached storage may be used to remove stale VTL configuration data from a drive that is known to be in good health.

This operation erases all information stored on your drive; back up data before selecting **Commit**.



CAUTION

Data is erased during this process. Back up your data before selecting Commit. These operations have a negative impact on the performance of normal operations; all activity should be stopped.

- 1 If you are not already in the FastStream GUI, type the IP address of your appliance, as found in [Use the FastStream VT 5300 GUI](#) on page 23, in a standard browser, click **Enter Here** and type in your username and password.

- 2 Click the **Diagnostics** button
- 3 Click the **Initialize and Verify** button or the **Initialize Only** button.
- 4 Click **Next**
- 5 Click on the drives you wish to test; the drives are highlighted.
- 6 Select **Initialize and Verify**
- 7 Click **Commit**
- 8 A warning message displays; choose **yes** to continue.
- 9 The **Drive Performance and Health** screen appears
- 10 The **Time Remaining** box tells you how much time remains until the process is complete. The representation of each drive in the **Drives** box shows the percentage completed.

Update firmware

The ATTO FastStream VT 5300 has several processors which control the flow of data. The firmware to control these processors can be upgraded in the field using the PUT command from an FTP connection or the zModem utility over an RS-232 serial connection.

Preliminary steps

- 1 The ATTO FastStream VT 5300 firmware is distributed as a compressed .zip file. Uncompress the .zip file into an image file (.ima). Note the filename. The .zip file can be uncompressed using any utility that supports the zip format.



CAUTION

Ensure that all I/O to the ATTO FastStream VT 5300 has stopped.

During this procedure, do not interrupt the flash process. Do not power down the host or the ATTO FastStream VT 5300 until the display returns the Ready prompt.

Interrupting the flash process makes your ATTO FastStream VT 5300 inoperable and you will have to return it to ATTO for repair.

- 2 Decide whether to use FTP over Ethernet or a terminal program using the RS-232 serial link, and continue with one of the following procedures.

Use FTP over Ethernet

- 1 Establish an FTP link to the ATTO FastStream VT 5300 that is to be flashed.
- 2 Use the **PUT** command to download the firmware. For example

```
PUT c:\firmware\FS5300100.IMA
```

- 3 Once the download is complete, cycle power on the ATTO FastStream VT 5300 to implement the new firmware.

Use the RS-232 serial link

- 1 Load a Terminal Program such as Hyper Terminal.
- 2 Set the terminal and the ATTO FastStream VT 5300 for the highest possible baud rate for your terminal.

- 3 Turn on power to the ATTO FastStream VT 5300.
- 4 Once the Ready prompt appears, type **ZMODEM RECEIVE**. The ATTO FastStream VT 5300 displays that it is preparing to receive a file from your terminal program.
- 5 On the terminal program, choose **Transfer Send File**
- 6 In the **Send File** box, type in the current ATTO FastStream VT 5300 **.ima** file or click the browse button to find it
- 7 Click **Send File**
- 8 The ATTO FastStream VT 5300 should acknowledge receiving the file and display a message not to interrupt power for 90 seconds.
- 9 Once the download is complete, cycle power on the ATTO FastStream VT 5300 to invoke the new firmware.

6.0 Interface options

The best way to manage, monitor and configure the FastStream VT 5300 is to use its GUI, but you may use a terminal emulation program or Telnet.

The FastStream VT 5300 GUI is the preferred method to operate and manage the FastStream VT 5300. However, it may be necessary to use other methods to access the FastStream VT 5300, such as to change the username and password (refer to [Customize the username, password](#) on page 11).



CAUTION

Changing parameters other than those offered in the FastStream VT 5300 GUI may cause loss of data and/or disruption to performance and reliability of the FastStream.

Use the FastStream VT 5300 GUI

Use the FastStream VT 5300 GUI to manage, monitor and configure the unit. The choices you make lead you from screen to screen. Choices which are not available are greyed out.

- 1 Working from the computer attached to the FastStream VT 5300 Ethernet port, open your browser and type in the FastStream VT 5300 IP Address as noted in [Discover the IP address](#) on page 5.
- 2 Your browser points to the FastStream VT 5300 splash screen. Press **Enter**.

- 3 Type in the username and password values.



Note

The default values are username: "root" and password: "Password". The username is case insensitive and the password is case sensitive

The pages which next appear depend on whether or not you have begun configuring the FastStream VT 5300. Refer to [Configure Virtual Tape](#) on page 7.

Use the serial port

To connect to a terminal emulation program or Telnet to manage the FastStream VT 5300, use the serial port.

- 1 Connect a cable from FastStream VT 5300 RS-232 serial port or header to the serial (COM) port on a personal computer.
- 2 Turn on the FastStream VT 5300.
- 3 Start a terminal emulation program on the personal computer, and use it to connect to the FastStream VT 5300. For example, if you are using HyperTerminal on a computer running a Windows operating system,
 - a. Type **FastStream VT 5300** in the **New Connection** dialog box.
 - b. Click **OK**.
 - c. In the **Connect To** dialog box, for the **Connect using field** select the COM port

number to which your serial cable is connected.

- d. Click **OK**.
 - e. In the COM Properties dialog box select the following values:
 - Bits per second: 115200
 - Data Bits: 8
 - Parity: None
 - Stop Bits: 1
 - Flow Control: None
 - Terminal type: ASCII
 - Echo: on
 - f. Click **OK**.
- 4 After you connect to the FastStream VT 5300, start-up messages are displayed. The last line in the start-up message sequence is **Ready**. See the example in Exhibit 5 on page 24.

Make adjustments to the FastStream VT 5300 using the Command Line Interface as described in [CLI provides an ASCII-based interface](#) on page v of the Appendix..



Note

*In serial port sessions, there is no prompt on the line below the word **Ready**. Begin typing commands in the blank line where the cursor is resting. No username or password is required for serial port access.*

- 5 To verify that you have connected successfully, type **help** after the **Ready** prompt and press **Enter**.

Use Telnet

Up to three Telnet sessions can be conducted simultaneously. A serial port session can use the CLI while Telnet sessions are open. Whichever session issues the first “set” CLI command can continue to issue set commands, while the other sessions can only issue “get” commands or display information. Once a connection is established, refer to [CLI provides an ASCII-based interface](#) on page v of the Appendix..

- 1 Connect to the FastStream VT 5300 from a computer on the same Ethernet network.
- 2 Start a Telnet session.



Note

There is more than one way to connect to the FastStream VT 5300 using a telnet

If a list of all available commands does not appear on the screen, review the steps in this section, check the cable, or contact service personnel until the problem is solved.

If you have difficulty using the serial port, verify that you have the correct settings and that your serial cable is less than two meters long.

program. Your telnet program may operate differently than in the following instructions.

- 3 At the telnet prompt, issue the **open** command where x.x.x.x is the IP address of the FastStream VT 5300.

```
telnet > open x.x.x.x
```

- 4 If you have to specify a port type, type in the port type “telnet” and the terminal type “vt100”.

```
port type: telnet
terminal type: vt100
```

- 5 Type in the default values for the username, “root”, and the password, “Password”, if you did not set new values in [Discover the IP address](#) on page 5.

Appendix A Cabling

Additional information to physically connect ports to devices and to your SAN.

SCSI cabling

Cables and devices must be chosen to maximize performance and minimize the electrical noise from the high-speed data transfers available with the SCSI protocol. Cabling and termination methods become important considerations for proper performance. SCSI cables and devices are subject to specific length and number limitations to deal with electrical problems that arise at increased operating speeds.

Cable types

Use high-quality cables rated for the type of SCSI transfers required: well-insulated SCSI cables ensure error free communications. Try to keep cable lengths as short as possible to ensure higher signal quality and performance.



Note

UltraSCSI is very sensitive to SCSI bus noise, cable distances and the number of devices connected on the SCSI bus. Carefully connect your devices when working with UltraSCSI.

Exhibit A-1 Various types of SCSI operate at different speeds and require different bus lengths to support a certain number of devices.

STA terms	Bus speed MB/sec. maximum	Bus width bits	Max. bus lengths in meters			Maximum device support
			Single- ended	Differential	LVD	
Fast SCSI	10	8	3	25	NA	8
Fast/WIDE SCSI	20	16	3	25	NA	16
UltraSCSI	20	8	1.5	25	NA	8
Ultra/WIDE SCSI	40	16	NA	25	NA	16
Ultra/WIDE SCSI	40	16	1.5	NA	NA	8
Ultra/WIDE SCSI	40	16	3	NA	NA	4
Ultra2 SCSI	80	16	NA	NA	12	8
Ultra2/WIDE SCSI	80	16	NA	NA	12	16
Ultra160/WIDE SCSI	160	16	NA	NA	12	16
Ultra320 SCSI	320	16	NA	NA	12	16

Connecting SCSI devices to SCSI ports

SCSI ports connect SCSI storage devices to the network. Each SCSI port is totally independent from the other SCSI port.

Each SCSI port is a bus capable of supporting 15 devices and each bus is capable of 40, 80 or 160 MB/sec. (Ultra, Ultra2 or Ultra160) transfer rates.

Each SCSI bus auto-negotiates the appropriate sync rates with the connected devices. If slower devices are mixed with faster devices, the bus

communicates at the rate of the slowest device, thus wasting the performance capabilities of the faster devices. Connect slower devices to one SCSI port and connect faster devices to the other port.

The FastStream supports a wide variety of SCSI storage devices including stand-alone drives, removable drives, JBODs, RAIDs, tape, CD and DVD drives, changers and libraries.

- 1 Connect the cable from the SCSI device to a VHDCI SCSI port on the FastStream VT 5300.
- 2 Check the type of cable, cable length limit and number of devices recommended for the port. See Exhibit A-1.
Keep cable lengths as short as possible to ensure the highest signal quality and performance. These cable lengths include the wiring inside the devices.
- 3 Set the IDs of the SCSI devices connected to the FastStream to a value other than 7.
Use a sequential ID starting at 0 for each device. The SCSI port has an internal factory setting ID of 7, typical for a SCSI initiator device.
- 4 Terminate the SCSI bus after the last device. The FastStream VT 5300 is terminated internally.

Fibre Channel connections

The Fibre Channel port connects the FastStream VT 5300 into either a Fabric or Arbitrated Loop. The FastStream VT 5300 uses optical SFP connectors and multimode fiber optic cable.

Make sure all cables are anchored securely at both ends with the proper connectors. Use the shortest possible cable length for best performance.

Cable length	Cable size
Up to 175 meters	62.5 micron
Up to 500 meters	50 micron

Appendix B Designing RAID groups

The ATTO FastStream VT 5300 provides instant hardware data protection and intelligence to existing SCSI storage independent of the storage type.



CAUTION

Selecting RAID configuration causes all previous storage data on the drive to be erased. Make sure all of your information is backed up before setting up RAID groups.

The ATTO FastStream VT 5300 allows RAID functionality. In general, the process begins with individual drives also called block devices.



Note

If a drive has corrupt or outdated configuration data, that drive cannot be assigned to any RAID Group. Ensure all drives to be assigned to RAID groups are configured properly. Refer to [Initialize and verify drives](#) on page 17.

A RAID Group is a virtual, independent single drive whose data is written to physical drives according to a RAID algorithm. The ATTO FastStream VT 5300 supports JBOD, RAID Level 0, RAID Level 1, RAID Level 10 and RAID Level 5.

JBOD (Just a Bunch of Disks)

JBOD (Just a Bunch of Disks) configuration allows many individual drives to be available for normal storage operations with no special data protection.

Using the ATTO FastStream VT 5300 allows you to concatenate several individual drives into one large drive.

A JBOD drive can be constructed as a special case of a RAID Group. When multiple physical drives are assigned to a JBOD RAID Group, their storage areas appear as a single spanned area of storage. The ATTO FastStream VT 5300 supports 1 to 32 drives per JBOD-configured RAID Group.

Exhibit A-2 JBOD: Just a Bunch of Disks: no redundancy; each disk is treated independently

JBOD

Disk 0	Disk 1	Disk 2
D0	D4	D8
D1	D5	D9
D2	D6	D10
D3	D7	D11

RAID Level 0

RAID Level 0 (striping) is based on the fact that increased performance can be achieved by simultaneously accessing data across multiple drives, increasing data transfer rates while reducing average access time by overlapping drive seeks. RAID Level 0 groups provide data that is striped across several drives. Drives are accessed alternately, as if stacked one on top of the other.

RAID Level 0 provides no data protection. If one drive fails, all data within that stripe set is lost.

The ATTO FastStream VT 5300 supports 2 to 32 drives per RAID Level 0 group.

RAID Level 0 is used by applications requiring high performance for non-critical data.

Exhibit A-3 Exhibit 1.0-2 RAID Level 0, no redundancy

RAID Level 0

Stripe	Disk 0	Disk 1	Disk 2	Disk 3	Disk 4	Disk 5
0	D0	D1	D2	D3	D4	D5
1	D6	D7	D8	D9	D10	D11
2	D12	D13	D14	D15	D16	D17
3	D18	D19	D20	D21	D22	D23

RAID Level 1

RAID Level 1 ensures the security of data by writing the exact same data simultaneously to two or more different drives. This application is for

users with critical data which cannot be lost or corrupted due to the failure of a single drive.

With RAID Level 1, the host sees what it believes to be a single physical drive of a specific size: it does not know about the mirrored pair.

The ATTO FastStream VT 5300 manages where data is written and read, allowing one drive to fail without the host knowing it has failed. RAID Level 1 is used in applications containing mission critical data. The ATTO FastStream VT 5300 supports an even number of 2 to 32 drives per RAID Level 1 group.

Exhibit A-4 RAID Level 1: Data is written to two or more drives simultaneously.

RAID Level 1

Stripe	Disk 0	Disk 1	Disk 2	Disk 3	Disk 4	Disk 5
0	D0	D0	D4	D4	D8	D8
1	D1	D1	D5	D5	D9	D9
2	D2	D2	D6	D6	D10	D10
3	D3	D3	D7	D7	D11	D11

RAID Level 10

RAID Level 10 increases data transfer rates while ensuring security by writing the exact same data simultaneously to two or more different drives. RAID Level 10 is used in applications requiring high performance and redundancy, combining the attributes of RAID Levels 1 and 0.

The ATTO FastStream VT 5300 supports an even number of 4 to 32 drives per RAID Level 10 group.

Exhibit A-5 RAID Level 10 with mirroring and spanning; redundancy is shown in shaded blocks.

RAID Level 10

Stripe	Disk 0	Disk 1	Disk 2	Disk 3	Disk 4	Disk 5
0	D0	D0	D1	D1	D2	D2
1	D3	D3	D4	D4	D5	D5
2	D6	D6	D7	D7	D8	D8
3	D9	D9	D10	D10	D11	D11

RAID Level 5

RAID Level 5 increases reliability while using fewer drives than mirroring by employing parity redundancy. Distributed parity on multiple drives allows you to rebuild a failed drive from the remaining good drives. The ATTO FastStream VT 5300 operates in degraded mode if a drive fails.

The ATTO FastStream VT 5300 supports 3 to 32 drives per RAID Level 5 group.

Exhibit A-6 RAID Level 5 with parity blocks shaded.

RAID Level 5

Stripe	Disk 0	Disk 1	Disk 2	Disk 3	Disk 4	Disk 5
0	D0	D1	D2	D3	D4	P0-4
1	D6	D7	D8	D9	P5-9	D5
2	D12	D13	D14	P10-14	D10	D11
3	D18	D19	P15-19	D15	D16	D17
4	D24	P20-24	D20	D21	D22	D23
5	P25-29	D25	D26	D27	D28	D29

Appendix C CLI provides an ASCII-based interface

The command line interface (CLI) uses ASCII commands typed while in CLI mode.



CAUTION

Do not use CLI unless you are directed to by an ATTO technician.

Changing parameters may cause loss of data and/or disruption to performance and reliability of the FastStream.

The FastStream VT 5300 GUI is the preferred method to operate and manage the FastStream VT 5300. Refer to [Interface options](#) on page 23 for details.

The command line interface (CLI) is a set of ASCII-based commands which perform configuration and diagnostic tasks. Refer to [Interface options](#) on page 23.

- CLI commands are context sensitive and generally follow a standard format

```
[Get|Set] Command [Parameter1|Parameter2]
```

followed by the **return** or **enter** key

- CLI commands are case insensitive: you may type all upper or all lower case or a mixture. Upper and lower case in this manual and the **help** screen are for clarification only.
- Commands generally have three types of operation: get, set and immediate.

- The get form returns the value of a parameter or setting and is an informational command.
- Responses to get commands are followed by **Ready**.
- The set form is an action that changes the value of a parameter or configuration setting. It may require a **SaveConfiguration** command and a restart of the system before it is implemented. The restart can be accomplished as part of the **SaveConfiguration** command or by using a separate **FirmwareRestart** command. A number of set commands may be issued before the **SaveConfiguration** command.
- Responses to **set** commands are either an error message or **Ready**. *. The asterisk indicates you must use a **SaveConfiguration** command to finalize the **set** command.
- Set commands which do not require a **SaveConfiguration** command, defined as immediate commands, are immediately executed.



Note

Using CLI commands during normal operation can cause a performance drop. Once command actions are complete, performance should return to normal levels.

Exhibit A-7 Symbols, typefaces and abbreviations used to indicate functions and elements of the command line interface used in this manual.

Symbol	Indicates
[]	Required entry
< >	Optional entry
	pick one of
\n	end of line
-	a range (6 – 9 = 6, 7, 8, 9)
Boldface words	must be typed as they appear
<i>Italicized words</i>	Arguments which must be replaced by whatever they represent
fl	Fibre Channel lun number (0 <= fl <= 31)
fp	Fibre Channel port number (0<= fp <= 2)
sb	SCSI bus number (0<= sb <= 3)
sl	SCSI lun ID (0 <= sl <= 7)
st	SCSI target ID (0 <= st <= 15)

Symbol	Indicates
mp1	Ethernet port used to manage the FastStream VT 5300
BlockDevID	index designation of a block device not assigned to any other RAID Group
cap	capacity of the block device
DevIndex	index designation of the RAID member
GroupName	ASCII name of a RAID Group
grpName	the name of the RAID Group to which the block device is assigned, or blank if the block device is available
id	index designation of a block device
ileave	interleave of RAID Group in blocks
mem	number of RAID members in the RAID Group
MemberIndex	index designation of a RAID Group member
numLines	number of output lines to follow
prodId	16-character ASCII SCSI product ID of the RAID member
rebuildStatus	rebuild status: OK, INPROGRESS, FAULTED or HALTED
rev or rv	4-character ASCII Revision string of the RAID member
serNum	least significant 16 digits of the RAID member's serial number
stat or status	current RAID Group status--NEW, ONLINE, DEGRADED, WAITING, or OFFLINE
type	RAID Group type: JBOD, RAID0, RAID1, or RAID10
vld or vendid	8-character ASCII SCSI vendor ID of the RAID member

CLI error messages

The following error messages may be returned by the Command line Interface

ERROR. Invalid Command. Type 'Help' for command list.

ERROR. Wrong/Missing Parameters

Usage: <usage string>

ERROR Invalid RAID Group state

ERROR Invalid Block Device index

ERROR Invalid RAID Member index

ERROR Maximum number of RAID Groups exceeded

ERROR Insufficient number of RAID Group members

ERROR

Block Device at specified index no longer available

ERROR Insufficient RAID Group members for RAID type

CLI summary

The following chart summarizes the Command Line Interface commands, their defaults, and an example of how to enter the commands. Commands which have no default values have a blank entry in that column of the table.



CAUTION

Do not use CLI unless you are directed to by an ATTO technician.

Changing parameters may cause loss of data and/or disruption to performance and reliability of the FastStream.

The FastStream VT 5300 GUI is the preferred method to operate and manage the FastStream VT 5300. Refer to [Interface options](#) on page 23 for details.

Command	Default	Example
AutoMap		automap
AutoResume	all disabled	set autoresume all enabled
BlockDevClean		blockdevclean block ID
BlockDevIdentify		blockdevidentify Alpha
BlockDevIDStop		blockdevidstop alpha
BlockDevScan		blockdevscan
BridgeModel		get bridgemodel
BridgeName	" "	set bridgename Omega6
ClearEventLog		clear eventlog
Date	01/01/2000	set date 03:03:03
DefaultInterleave	128	set defaultinterleave 64
DHCPFixedDelay	0	set dhcpfixeddelay 15
DisplayEventLog		displayeventlog
DisplayEventLogFilter	all all	set displayeventlogfilter gen info
DriveTest		drivetest begin
DriveTestConfig	not initiated	set drivetestconfig read
DriveTestList		drivetestlist all
DriveTestStatus		get driveteststatus
DumpConfig		dumpconfig
DumpEventLog		dumpeventlog
EmailFromAddress		set emailfromaddress notify1@attotech.com
EmailNotify	disabled	set emailnotify enabled
EmailNotifyAddress		get emailnotifyaddress
EmailPassword		set emailpassword alpha123
EmailServerAddress	0.0.0.0	get emailserveraddress
EmailUsername		get emailusername
EthernetMDIX	MDI	ethernetmdix
EthernetSpeed	auto	set ethernetspeed 100
EventLog	enabled	set eventlog disabled
EventLogFilter	all all	set eventlogfilter gen info

Command	Default	Example
Exit		exit
FCConnMode	loop	set fconnmode ptp
FCDataRate	auto	get fcdata rate
FCHard	disabled	set fchard disabled
FCHardAddress	fp1=3; fp2=4	set fchardaddress 1 122
FCPortErrors		get fcporterrors
FCPortList		fcportlist
FCSCSIBusyStatus	busy	set fcscsibusystatus busy
FCWWName		get fcwwname 1
FirmwareRestart		firmwarerestart
Help		help driveinfo
HSAdd		hsadd 3
HSDisplay		hsdisplay
HSRemove		hsremove 3
IdentifyBridge	disabled	set identifybridge enabled
Info		info
IPAddress	10.0.0.1	get ipaddress mp1
IPDHCP	enabled	set ipdhcp mp1 disabled
IPGateway	0.0.0.0	get ipgateway mp1
IPSubnetMask	255.255.0.0	get ipsubnetmask mp1
IsReserved		isreserved
MaxOpTemp	70	get maxoptemp
Metrics		metrics display all
MinOpTemp	0	set minoptemp 10
OpTempWarn	5	set optempwarn 15
PartitionDisplay		partitiondisplay alpha1
Password	Password	set password
Performance		get performance 2
Ping		ping 192.42.155.155
QuickTape		refer to explanation QuickTape on page xiv
RAIDCommandTimeout	30000	raidcommandtimeout 10000
RAIDRebuildPriority	same	set raidrebuildpriority low
Reserve		reserve disabled
ResetFCPortErrors		resetfcporterrors 1
RestoreConfiguration		restoreconfiguration default
RGAddStorage		rgaddstorage g1 span commit
RGCancelAddStorage		rgcanceladdstorage g1
RGCommit		rgcommit all
RGCreate		rgcreate g1
RGDelete		rgdelete g1
RGDisplay		rgdisplay all

Command	Default	Example
RGHaltConversion		rghaltconversion g1
RGHaltRebuild		rghaltrebuild g1
RGMemberAdd		rgmemberadd g1 22
RGMemberRemove		rgmemberremove g1 22
RGRebuild		rgrebuild g1
RGResumeConversion		rgresumeconversion g1
RGResumeRebuild		rgresumerebuild g1
RGSpanDepth	1	set rgspandepth g1 22
RGSpeedRead	disabled	set regspeedread enabled
RGWaitTimeout	5	rgwaittimeout 30
RMState		set rmstate g1 online
RMStatus		rmstatus g1
Route		route Alpha1 delete
RouteDisplay		routedisplay SCSI
SaveConfiguration		saveconfiguration restart
SCSIInitId	0x07	set scsiinitid 2 12
SCSIPortBusSpeed	ultra320	set scsiportbusspeed 2 ultra160
SCSIPortList		scsiportlist
SCSIPortReset		scsiportreset 1
SCSIPortResetOnStartup	enabled	set scsiportresetonstartup 1 disabled
SCSIPortSelTimeout	250ms	
SCSIPortSyncTransfer	enabled	set scsiportsynctransfer 2 disabled
SCSIPortTermination	enabled	set scsiporttermination 1 enabled
SCSIPortWideTransfer	enabled	set scsiportwidetransfer 2 disabled
SCSITargetLUNs	8	set scsitargetluns 1 64
SCSITargets		scsitargets 1
SerialNumber		get serialnumber
SerialPortBaudRate	115200	set serialportbaudrate 19200
SerialPortEcho	enabled	get serialportecho
SNTP	enabled	get sntp
SNTPServer	192.43.244.18	set sntpserver 129.6.15.28
TailEventLog		taileventlog
TapeLibDelete		tapelibdelete barb2
TapeLibInfo		tapelibinfo barb1
TapeWriteProtect	disabled	tapewriteprotect all enabled
Temperature		get temperature
Time	00:00:00	set time 03:32:30
TimeZone	EST	set timezone pst
Username	root	set username Barbara
VerboseMode	enabled	set verbosemode disabled
VirtualDriveInfo		virtualdriveinfo

Command	Default	Example
Voltage		get voltage
WrapEventLog	enabled	set wrapeventlog disabled
zModem		zmodem receive

CLI command explanations

Command Line Interface commands are listed alphabetically with explanations of what they are used for, their defaults and syntax.



CAUTION

Do not use CLI unless you are directed to by an ATTO technician.

Changing parameters may cause loss of data and/or disruption to performance and reliability of the FastStream.

The FastStream VT 5300 GUI is the preferred method to operate and manage the FastStream VT 5300. Refer to [Interface options](#) on page 23 for details

AutoMap

Automap automatically maps a subset of target devices visible to the firmware. All previous maps are deleted.

AutoMap

AutoResume

Enables/disables the automatic continue feature for interrupted rebuild, erase and write pattern operations at startup. If AutoResume is enabled, all interrupted rebuild, erase and write pattern operations are continued at startup. Optional parameter GroupName specifies the RAID Group whose Restart features to be set. If no GroupName is specified, all existing RAID Groups are affected.

Default: all disabled

set AutoResume [Rebuild | Erase | WritePattern | all]
[enabled | disabled] <GroupName>

BlockDevClean

Removes any ATTO configuration data from the block device with the specified BlockDevID. BlockDevID is the index of a block device provided by the **BlockDevScan** CLI command.

BlockDevClean [BlockDevID]

Date

Regulates the current date for this unit. The date range is 1/1/2000 to 12/31/2099.

BlockDevIdentify

Causes the I/O LED of the drive to illuminate for one minute if it is accessible through the SCSI port



CAUTION

The BlockDevIdentify command is intended for diagnostic purposes only. Executing this command may adversely impact the performance and throughput of the FastStream for the time that the LED is illuminated.

BlockDevIdentify <Groupname> [BlockDevID | MberIdx]

BlockDevIDStop

Turns off the IO LED of a previously identified disk drive.

BlockDevIDStop

BlockDevScan

Lists all currently connected physical drives along with any potential RAID Group association. Each block device listed is assigned a unique index at the time of the scan to identify drives for other CLI operations.

BlockDevScan

BridgeModel

Reports model information about the FastStream.

get BridgeModel

BridgeName

Specifies the eight-character name assigned to the FastStream used to identify individual FastStream units. It is not the World Wide Name. The string is alphanumeric, eight characters long.

Default: ""

set BridgeName [value]

Requires a SaveConfiguration command

get BridgeName

ClearEventLog

Clears the contents of the event log. No new entries are recorded until ClearEventLog has completed.

ClearEventLog

Default: 01/01/2000

set Date [MM] [DD] [YYYY]

get Date

DefaultInterleave

DefaultInterleave assigns or retrieves the system-default interleave size for new RAID Groups. If an interleave size is not explicitly specified when a RAID Group is created, then the DefaultInterleave value is used instead.

Default: 128
set DefaultInterleave [16 | 32 | 64 | 128 | 256]
get DefaultInterleave

DHCPFixedDelay

Selects/displays the delay, in seconds, between DHCP client request intervals, from between 0 seconds to 255 seconds. 0 time is typical.

Default: 0 (no delay)
set DHCPFixedDelay [0 - 255]
get DHCPFixedDelay

DisplayEventLog

*Displays the most recent page of event log entries. Typing a +, - or = causes the next, previous or same page of event log entries to be displayed. No events are recorded until the command has been completed. Type **q** to disable the command, begin new log entries, and return to CLI.*

DisplayEventLog <+ | - | = | q >

DisplayEventLogFilter

*Filters the display of data for specified subsystems and levels during **DisplayEventLog** mode. Valid event log subsystem entries are platform-dependent.*

Subsystem	Levels
ECC	INFO
ENET	WARN
GEN	CRIT
HTTP	FAIL
NVRAM	ALL
PERF	
SCSI	
NDMP	
FC	
ALL	

Default: all all
set DisplayEventLogFilter [subsystem | all] [level | all]
get DisplayEventLogFilter [subsystem | all] [level | all]

DriveTest

Immediate command which starts or stops a drive test with the previously specified configuration and drive list. Drives which are in-use by the test are not available for RAID configuration or RAID operations. Only one test can be run at a time.

DriveTest [Begin | Cancel]

DriveTestConfig

*Configures the next drive test to perform one of the following operations: initialize (destructive write-only), read (non-destructive read-only), verify (destructive verify), or init-verify (destructive write-read-verify). The test is not started until the **DriveTest Begin** command is given.*

Default: not initiated
set DriveTestConfig [init | read | verify | init-verify]
get DriveTestConfig

DriveTestList

*Specifies drives to be run in the next drive test including drives which are not part of a RAID group and not Hot Spares. The **all** parameter automatically chooses eligible drives. The test is not started until the **DriveTest Begin** command is given.*

set DriveTestList [drive [BlockDevID] | all]
get DriveTestList

DriveTestStatus

*Displays the status of the currently running drive test but does not display performance metrics. If a block device ID is not running or cannot be found, its state is **idle** and percent complete is **0**.*

get DriveTestStatus <drive [BlockDevID]>

DumpConfig

Displays a unit's configuration.

DumpConfig

DumpEventLog

Dumps the contents of the entire event log to the current CLI session without impact on the log itself (the log is not cleared). No events are recorded until the command has been completed.

DumpEventLog

EmailFromAddress

Configures the E-mail address that the FastStream uses to talk to the E-mail server. Full E-mail address is a fully qualified Internet E-mail address, not more than 128 characters.

set EmailFromAddress [full email address]
get EmailFromAddress

EmailNotify

Regulates E-mail notification.

Default: disabled.
set EmailNotify [enabled | disabled]
Requires a SaveConfiguration command
get EmailNotify

EmailNotifyAddress

Configures notification addresses using an index (a number between 1 and 5, inclusive), the full E-mail address of the recipient, a fully qualified Internet E-mail address not more than 128 characters long, and a level.

Levels are

None: no E-mails sent.

Critical: critical event notification.

Warning: warnings and critical event notification.

All: all warnings, critical events

set EmailNotifyAddress [index] [full email address]
[warning level]

get EMailNotifyAddress

EmailPassword

Configures the password used to authenticate the login to the SMTP email server. The password must not be more than 64 characters. A password is not required if the email server does not require authentication.

set EmailPassword

EmailServerAddress

Configures the address of the server that the FastStream should contact in order to send E-mails.

Default: 0.0.0.0

set EmailServerAddress [IP address]

get EmailServerAddress

EmailUsername

Configures the username used to authenticate the login to the SMTP email server. The username must not be more than 128 characters. A username is not required if the email server does not require authentication.

set EmailUsername [Username]

get EmailUsername

EthernetMDIX

Specifies the Ethernet twisted-pair connection type.

The **MDI** setting connects the unit's Ethernet port to an Ethernet hub or switch port with a standard Ethernet patch cable (or to a PCI card with a cross-over cable).

The **MDIX** setting connects the unit's Ethernet port to an Ethernet PCI card with a standard Ethernet patch cable (or to a hub or switch with a cross-over cable).

The **Auto** setting attempts to automatically determine the correct setting.

Default: MDI

set EthernetMDIX [mp1] [MDI | MDIX | auto]

get EthernetMDIX [mp1]

EthernetSpeed

Sets/displays the current speed of the Ethernet connection. Choices are **10**, **100**, and **Auto**.

Default: auto

set EthernetSpeed [mp1] [10 | 100 | Auto]

Requires a SaveConfiguration command

get EthernetSpeed [mp1]

EventLog

When enabled, records various system errors to the event log.

Default: enabled

set EventLog [enabled | disabled]

get EventLog

EventLogFilter

Filters data from specific unit subsystems and levels when event logging is enabled. The specific entries supported are platform-dependent.

Subsystem	Levels
ECC	INFO
ENET	WARN
GEN	CRIT
HTTP	FAIL
NVRAM	ALL
PERF	
SCSI	
NDMP	
FC	
ALL	

set EventLogFilter [subsys | all] [event level | all] [all | none]

get EventLogFilter [subsystem] [level]

Exit

Exits the current Ethernet telnet CLI session; it has no effect if used during a serial or in-band CLI session.

Exit

FCConnMode

Controls/reports the connection mode the FastStream uses when communication across a FC network, either to an arbitrated loop (FC-AL) when you select **loop** mode, or point-to-point when you choose **ptp**. If you choose **loop-ptp** or **ptp-loop**, the FastStream tries to use the first parameter first.

Default: loop

set FCConnMode [fp] [loop | ptp | loop-ptp | ptp-loop]

Requires a SaveConfiguration command

get FCConnMode [fp]

FCDataRate

Specifies the rate the FastStream uses, 1 Gigabit/sec., 2 Gigabit/sec. 4 Gigabit/sec. or auto negotiate.

Default: auto

set FCDataRate [fp] [1Gb | 2Gb | 4Gb | auto]

Requires a SaveConfiguration command

get FCDataRate

FCHard

*Used to enable or disable FC hard address assignment. Under soft addressing, the FastStream loop address is assigned during loop initialization. If you enable hard addressing use **FCHardAddress** (described below).*

Default: disabled

set FCHard [enabled | disabled]

Requires a SaveConfiguration command

get FCHard

FCHardAddress

Sets/displays the value used as the FC-AL hard address. This hexadecimal value represents the address the FastStream tries to use if hard addressing is enabled. When an address is not set, the current value is displayed. The valid range of values is 0 through 125.

Default fp1=3; fp2=4

set FCHard Address [fp | [address]]

Requires a SaveConfiguration command

get FCHardAddress [fp]

FCPortErrors

FCPortErrors displays the number of Fibre Channel errors that have occurred since the last reboot/power-on or ResetFCPortErrors.

get FCPortErrors

FCPortList

Returns a list of available FC ports and their current status. Valid status values are OK and Failed.

FCPortList

FCSCSIBusyStatus

Chooses to report BUSY or QUEUE FULL when a unit is unable to accept a SCSI command.

Default: busy

set FCSCSIBusyStatus [busy | qfull]

Requires a SaveConfiguration command

get FCSCSIBusyStatus

FCWWName

Reports the Word Wide Name (WWN) of the FC interface. Each FC port has an individual and unique WWN. The least significant 3 bytes of the WWN are used as the Ethernet MAC address. The lower nibble of the highest byte designates the port number.

get FCWWN [fp]

FirmwareRestart

*Resets and reinitializes the unit firmware. Use the **forced** option to override any CLI reservations held by other sessions.*

FirmwareRestart <forced>

Help

Displays a list of available commands. If command name is specified, displays detailed command-specific information.

Help <command name>

HSAdd

Assigns a Block Device to the Hot Spare pool.

HSAdd [BlockDevID]

HSDisplay

Lists all devices in the Hot Spare pool.

HSDisplay

HSRemove

Removes a Block Device from the Hot Spare pool

HSRemove [BlockDevID]

IdentifyBridge

Enabling this option causes the front panel Ready LED of the FastStream to blink until the parameter is disabled.

Default: disabled

set IdentifyBridge [enabled | disabled]

get IdentifyBridge

Info

Displays version numbers and other production information for key components.

Info

IPAddress

*Regulates the current FastStream IP address. If IPDHCP is enabled (see below), get command reports current IP address assigned by DHCP server. Setting this value always modifies the internal NVRAM value of the IP Address, whether or not a **SaveConfiguration** is performed.*

Default IP Address: 10.0.0.1

set IPAddress [mp1] xxx.xxx.xxx.xxx

get IPAddress [mp1]

IPDHCP

Selecting DHCP allows the FastStream to request an IP address from the network. The network must have at least one DHCP server.

Default: enabled

set IPDHCP [mp1] [enabled | disabled]

Requires a SaveConfiguration command

get IPDHCP [mp1]

IPGateway

Controls the current default gateways used by any Ethernet port(s) on the unit. If IPDHCP is enabled, the 'get' command reports the current IP gateway assigned by the network DHCP server.

Default: 0.0.0.0

set IPGateway [mp1] [xxx.xxx.xxx.xxx]

get IPGateway [mp1]

IPSubnetMask

Sets/displays the current subnet mask. If IPDHCP is enabled (see above), get command reports current subnet mask assigned by DHCP server. Setting this value always modifies the internal NVRAM value of the IP subnet mask whether or not a SaveConfiguration is performed.

Default: 255.255.0.0

set IPSubnetMask xxx.xxx.xxx.xxx

get IPSubnetMask

IsReserved

Displays the reservation status of the current unit.

IsReserved

MaxOpTemp

Regulates the maximum operating temperature of this unit in degrees Celsius. Valid entries are between 55 and 70 degrees.

Default: 70

set MaxOpTemp [55 – 70]

get MaxOpTemp

Metrics

Controls the collection of standard data metrics within a product via the command's Start, Stop and Display parameters.

Metrics [Start | Stop | Display] [drive [BlockDevID] | all | running]

MinOpTemp

Regulates the minimum operating temperature of this unit in degrees Celsius. Valid entries are between 0 and 15 degrees.

Default: 0

set MinOpTemp [0 – 15]

get MinOpTemp

OpTempWarn

Regulates the number of degrees Celsius before a thermal control event precipitates a warning to the user. Valid entries are between 0 and 15 degrees.

Default: 0

set OpTempWarn [0 – 15]

get OpTempWarn

PartitionDisplay

Lists all the partitions available in the specified RAID Group. The partitions are listed in order of contiguousness (as opposed to index order).

PartitionDisplay [GroupName]

Password

Specifies password for all non-serial sessions: Telnet, ftp and FastStream browser-based user interface. You are prompted for the current password, to type the new password, and to confirm the new password. If local **echo** is enabled, password echoes all * characters. In verbose mode only, CLI requests the password be re-typed. When the password is all 0s, Telnet and ftp do not validate the password and MD5 authentication is disabled. Passwords are case sensitive and can be 1-32 characters long with no spaces.

Default: Password

set Password

Requires a SaveConfiguration command

Performance

Returns the performance data for the FC port you specify. Data includes the average rate (MB per sec.) and number of I/Os measured over the previous sampling period where a sampling period is approximately one second. Successful SCSI Read (08h, 28h) and Write (0ah, 2Ah) commands are considered I/Os. Reported performance may be affected by FC port and SCSI bus availability and saturation, SCSI device speeds and overall system use.

get Performance <fp>

Ping

Sends an ICMP echo request to the specified host.

ping [mp1] [xxx.xxx.xxx.xxx] <count <size>>

QuickTape

Sets up virtual tape configuration.

QuickTape [TapeLibraryName] [# tape drives] # tape volumes] [RAID Group Name] [MC Vendor ID] MC Product ID] [MC Revision] [TD Vendor ID] [TD Product ID] [TD Revision] [Medium Type] [Hot Spares RAID Group Name | disabled] <Barcode prefix>

RAIDCommandTimeout

Specifies in milliseconds the range of time the drives have to respond. You must use **RGCommit** before using this command.



CAUTION

If you set this value too low, failures may occur during normal operation.

Default: 30000

set RAIDCommandTimeout [100 - 3600000]

get RAIDCommandTimeout

RAIDRebuildPriority

Sets or displays the RAID rebuild priority. A RAID rebuild priority set to **high** gives higher priority to RAID rebuilds and lower priority to the processing of simultaneous I/O transactions. A RAID rebuild priority set to **low** gives lower priority to the rebuild and a higher priority to I/O transactions. Set **same**, the RAID rebuild and processing of I/O transactions is the same.

Default: same

set RAIDRebuildPriority [high | low | same]

get RAIDRebuildPriority

Reserve

Reports the state of CLI reservation for the current CLI session. If the command reports that Reservations are enabled, then another CLI session has control of parameter modification on the unit.

Reserve

ResetFCPortErrors

ResetFCPortErrors resets all Fibre Channel error counts for the specified port to zero. See FCPortErrors.

ResetFCPortErrors [fp]

RestoreConfiguration

Issued with the **default** option, forces the unit NVRAM settings to their original defaults. The **saved** option undoes any changes made to this session since the last save.

RestoreConfiguration < Default | Saved >

RGAddStorage

Adds additional storage to an existing RAID Group.

Mirror|Stripe|Span specifies the method used to expand the storage. Optional parameter BlockDeviceID specifies available block device(s) to be added to the RAID Group. Optional parameter **commit** specifies that the **RGCommit** command is run automatically.



Note

Mirrors cannot be added to a RAID 5 group.

RGAddStorage [GroupName] [Mirror | Stripe | Span]
<BlockDeviceID> <commit>

RGCancelAddStorage

Cancels the **RGAddStorage** command.

RGCancelAddStorage [GroupName]

RGCommit

Stamps a NEW RAID Group's configuration to its member drives. After this command, a RAID Group can be considered operational and transitions from the NEW state to the **Online**, **Degraded**, or **Offline** state depending on the health of the selected member drives. **RGCommit** also stamps an EXISTING RAID Group's configuration to its member drives, when the EXISTING RAID Group is in the process of having storage added.

RGCommit [GroupName | all]

RGCreate

Creates a NEW empty RAID Group. GroupName is an ASCII name for the RAID Group (15 chars max, no spaces). The optional value after the RAID Group type parameter represents the desired interleave for the RAID Group. If this value is not provided then the system-default interleave size is used.

RGCreate [GroupName] [RAID [0|1|10|5] |JBOD]
<16|32|64|128|256>

RGDelete

Deletes the specified RAID Group. If **All** is used, the command deletes all existing RAID groups that do not have mapped Virtual drives. Any commands outstanding to the RAID Group when this command is issued are completed before deleting the RAID Group. A successful delete clears the configuration area of the member drives. This command fails if the specified RAID Group does not exist. You are asked to confirm the delete if you have enabled verbose mode.

RGDelete [GroupName | All]

RGDisplay

*Displays status information for a single RAID Group, or if **ALL** is used, all available RAID groups.*

RGDisplay [GroupName | All]

RGHaltConversion

Stops the conversion on the specified existing RAID Group.

RGHaltConversion [GroupName]

RGHaltRebuild

Stops the rebuild(s) on the specified existing RAID Group. MemberIndex specifies the RAID member whose rebuild is stopped. If no MemberIndex is specified, all rebuilds on that RAID Group are stopped.

RGHaltRebuild [GroupName] <MemberIndex>

RGMemberAdd

*Adds an available block device to a NEW RAID Group. This command fails if the specified RAID Group does not exist, if the specified RAID Group is not in the NEW state, or if the specified block device index does not represent an available device. The RAID Group cannot have been saved using the **RGCommit** command.*

RGMemberAdd [GroupName] [BlockDevID]

RGMemberRemove

*Removes a RAID member from a NEW RAID Group. This command fails if the specified RAID Group does not exist, if the specified RAID Group is not in the NEW state, or if the specified block device index does not represent an available device. The RAID Group cannot have been saved using the **RGCommit** command.*

RGMemberRemove [GroupName] [BlockDevID]

RGRebuild

Starts rebuilding the specified existing RAID Group. Optional parameter MemberIndex specifies the member to rebuild. If no member is specified, all degraded members are rebuilt. Optional parameter BlockDeviceID allows an available block device to be substituted for the RAID Member currently assigned to the MemberIndex.

RGRebuild [GroupName] <MemberIndex>
<BlockDeviceID>

RGResumeConversion

Continues the stopped conversion on the specified existing RAID Group.

RGResumeConversion [GroupName]

RGResumeRebuild

Continues the rebuild(s) on the specified existing RAID Group. MemberIndex specifies the RAID member whose stopped rebuild is continued. If no MemberIndex is specified, all stopped rebuilds on that RAID Group are continued.

RGResumeRebuild [GroupName] <MemberIndex>

RGSpanDepth

Sets the span depth on the specified existing RAID Group. The RAID Group must be RAID Level 0, RAID Level 1, RAID Level 5, or RAID Level 10.

Default: 1

set RGSpanDepth [GroupName] [SpanDepth [1-32]]
get RGSpanDepth [GroupName]

RGSpeedRead

*Performs look-ahead during reads from RAID Group member disks for **ALL** or the specified RAID Group. This command fails if the RAID Group does not exist. GroupName is the ASCII name of the RAID Group for which look-ahead reads are performed.*

Default: disabled

set RGSPEEDRead [GroupName | all] [enabled | disabled]
get RGSPEEDRead [GroupName | all]

RGWaitTimeout

*Specifies the maximum time in seconds that the system waits to discover previously-configured RAID groups attached to the drive. The timeout is used during system boot time and when the **BlockDevScan** command is issued.*

Default: 5

set RGWaitTimeout [1-3600]
get RGWaitTimeout

RMState

Sets the member state on the specified existing RAID Group member(s). RAID Group may not be in the NEW state. Optional parameter MemberIndex specifies the RAID Member whose status is to be set. If no MemberIndex is specified, the status of all members of the specified RAID Group is set.



Note

Members undergoing rebuild are not changed. Rebuilds on these members must first be stopped.

set RMState [GroupName] <MemberIndex> [Online |
Degraded | Unavailable | Faulted]
get RMStatus

RMStatus

Displays the status of all RAID Members within the specified RAID Group or a specific RAID member (if specified) within the specified RAID Group. This command fails if the specified RAID Group does not exist or a specified member index within the RAID Group does not exist.

RMStatus [GroupName] <MemberIndex>

Route

Assigns a SCSI LUN protocol address to a target. Use the **Delete** identifier to remove the map. In verbose mode, overwriting a map requires secondary confirmation of the action.

Route FC [lun] [[RAID [GroupName] | Delete]

RouteDisplay

Displays a list of Fibre Channel to SCSI address mappings on the FastStream.

RouteDisplay FC <fp> <fl>

SaveConfiguration

Issued with the restart option, cycles unit power after saving configuration changes. The **norestart** option saves changes without restarting.



Note

Certain modifications require a system restart.

SaveConfiguration <Restart | NoRestart>

SCSIInitID

Specifies or reports the SCSI initiator ID on the specified SCSI port as found in NVRAM. All maps coinciding with the user-specified **SCSIInitID** are destroyed after the command is issued.

Default: 7

set SCSIInitID [sb [0-15]]

get SCSIInitID

SCSIPortBusSpeed

Controls the transfer rate at which the unit attempts to negotiate with its SCSI devices.

Default: ultra320

set SCSIPortBusSpeed [sb] [fast | ultra | ultra2 | ultra160 | ultra320]

get SCSIPortBusSpeed [sb]

SCSIPortList

Returns a list of available SCSI ports and their current status. Valid status values are OK and Failed

SCSIPortList

SCSIPortReset

Resets the specified SCSI bus.

SCSIPortReset [sb]

SCSIPortResetOnStartup

Specifies if the SCSI port should be reset on power-up.

Default: enabled

set SCSIPortResetOnStartup [sb [enabled | disabled]]

Requires a SaveConfiguration command

get SCSIPortResetOnStartup [sb]

SCSIPortSyncTransfer

Specifies whether synchronous SCSI transfers should be negotiated with devices on the specified SCSI port.

Default: enabled

set SCSIPortSyncTransfer [[sb [enabled | disabled]]

Requires a SaveConfiguration command

get SCSIPortSyncTransfer [sb]

SCSIPortTermination

Configures/reports the SCSI internal termination of the SCSI port identified on the FastStream.

Default: enabled

set SCSIPortTermination [sb] [enabled | disabled]

Requires a SaveConfiguration command

get SCSIPortTermination [sb]

SCSIPortWideTransfer

Specifies whether wide SCSI transfers should be negotiated. **Enabled** allows wide transfer negotiation

Default: enabled

set SCSIPortWideTransfer [sb [enabled | disabled]]

Requires a SaveConfiguration command

get SCSIPortWideTransfer

SCSITargetLUNs

Sets the maximum number of SCSI LUNs per target the FastStream tries to query during a SCSI bus scan.

Default: 8

set SCSITargetLUNs [sb] [8 | 64]

Requires a SaveConfiguration command

get SCSITargetLUNs

SCSITargets

Returns a list of SCSI devices operational on the referenced SCSI port with SCSI target number, SCSI LUN number, device type, vendor ID, product ID, revision and serial number.

SCSITargets [sb]

SerialNumber

Reports the FastStream serial number which is unique for each FastStream. The serial number tracks the board throughout its life and should not be changed.

get SerialNumber

SerialPortBaudRate

Configures the baud rate for the unit's RS-232 serial port. The number of data bits is fixed at 8 with no parity.

```
set SerialPortBaudRate [ 2400 | 9600 | 19200 | 38400 |  
57600 | 115200 ]  
get SerialPortBaudRate
```

SerialPortEcho

Controls if the unit echoes characters on its RS-232 port. When enabled, all non-control character keyboard input is output to the display.

```
Default: enabled  
set SerialPortEcho [enabled | disabled]  
get SerialPortEcho
```

SNTP

Controls whether SNTP time server is used.

```
Default: enabled  
set SNTP [enabled | disabled]  
get SNTP
```

SNTPServer

Controls or displays the main IP address the client uses to retrieve the SNTP time.

```
Default: 192.43.244.18  
set SNTPServer[xxx.xxx.xxx.xxx]  
get SNTPServer
```

TailEventLog

*Displays new events to the terminal. Type **q** and press **Enter** to exit tail mode.*

```
TailEventLog
```

TapeLibDelete

Deletes the specified tape library or all tape libraries.

```
TapeLibDelete [GroupName | all]
```

TapeLibInfo

Lists information for the specified tape library or all tape libraries.

```
TapeLibInfo [LibName | all]
```

TapeWriteProtect

Enables or disables write protection for a particular virtual tape or both virtual tapes.

```
set TapeWriteProtect [TapeVol ID | all] [enabled |  
disabled]  
get TapeWriteProtect
```

Time

Controls or displays the current time as clocked by the unit in 24 hour format. Time cannot be set while SNTP is enabled.

```
set Time [HH: MM: SS]  
get Time
```

TimeZone

Controls or displays the time zone or an offset from GMT for the unit.

```
set TimeZone [[EST | CST | MST | PST] | [+/-HH:MM]]  
get TimeZone
```

Username

Specifies the username used for all sessions: NDMP, Telnet, FTP and Webserver. Username is case insensitive, 1 to 32 characters, and cannot contain spaces.

```
Default: root  
set Username [username]  
get Username
```

VerboseMode

*Controls the level of detail in CLI **Help** output and command response output for the current CLI session.*

```
Default: enabled  
set VerboseMode [enabled | disabled]  
get VerboseMode
```

VirtualDriveInfo

Displays characteristics and statistics for all the available virtual drives or any available virtual drive identified by its virtual drive ID.

```
VirtualDriveInfo <VirtualDrive ID>
```

Voltage

Displays the voltage levels monitored by the FastStream.

Representations of the voltages are

```
VDDA: +3.31 V
```

```
Vddb: +2.49 V
```

```
VDDC: +1.5V
```

```
VDDD: +1.35V
```

```
ALL: all monitored voltages
```

```
get Voltage <VDDA |Vddb |VDDC VDDD | all>
```

WrapEventLog

When enabled, the FastStream logs up to 2,048 event entries before wrapping (overwriting the first entries). If disabled, the FastStream stops logging event entries when the buffer is full.

```
Default: enabled  
set WrapEventLog [enabled | disabled]  
get WrapEventLog
```

zModem

*Uses the zMODEM protocol to transfer a file to or from the unit via the RS-232 port. The filename to retrieve is required if the **send** option is specified.*

```
Zmodem [send [filename] | receive]
```

Appendix D Standards and compliances

The equipment described in this manual generates and uses radio frequency energy. If this equipment is not used in strict accordance with the manufacturer's instruction, it can and may cause interference with radio and television reception. See the ATTO FastStream VT 5300 Technical Specification sheet for your particular model for a full list of certifications for that model.



FCC Standards: Radio and Television Interference



WARNING

This equipment generates, uses, and can radiate radio frequency energy and, if not installed and used in accordance with the instruction manual, may cause interference to radio communications. It has been tested and found to comply with the limits for a Class B computing device pursuant to Subpart J of Part 15 of FCC rules, which are designed to provide a reasonable protection against such interference when operating in a commercial environment. Operation of this equipment in a residential area is likely to cause interference, in which case the user, at his own expense, will be required to take whatever measures may be required to correct the interference.

If this equipment does cause interference to radio and television reception, which can be determined by turning the equipment off and on, try to correct the interference by one or more of the following measures:

- Move the receiving antenna.
- Relocate the FastStream VT 5300 with respect to the receiver, or move the FastStream VT 5300 away from the receiver.
- Plug the computer into a different outlet so the computer and receiver are on different branch circuits.
- If necessary, consult an ATTO authorized dealer, ATTO Technical Support Staff, or an experienced radio/television technician for additional suggestions.

The booklet *How to Identify and Resolve Radio/TV Interference Problems* prepared by the Federal Communications Commission is a helpful guide. It is available from the US Government printing office, Washington, DC 20402, Stock No. 004-000-00345-4.

Further results of FCC Testing

In certain instances, extraordinary variances in the AC power supplied to this unit will require the operating system's normal error recovery procedure to retry the current SCSI command. In this case, the unit can fully recover with no loss of data, and without user intervention. Note that other exceptional conditions in addition to variances in the AC power, such as improper cabling or unrecognized commands, may also trigger these normal error recovery procedures.



Canadian Standards

This Class A digital apparatus complies with Canadian ICES-003.

Cet appareil numérique de la classe A est conforme à la norme NMB-003 du Canada.



European Standards

Declaration of Conformity

This following statement applies to the ATTO FastStream VT 5300.

This device has been tested in the basic operating configuration and found to be compliant with the following European Union standards:

Application of Council Directive: 89/336/EEC

Standard(s) to which conformity is declared: EN55022, EN50082-1, EN60950

This Declaration will only be valid when this product is used in conjunction with other CE approved devices and when the entire system is tested to the applicable CE standards and found to be compliant.



The ATTO FastStream VT 5300 complies with Directive 2002/95/EC on the Restriction of the Use of Hazardous Substances in Electrical and Electronic Equipment (RoHS).

Appendix E Warranty, contact information

Manufacturer limited warranty

Manufacturer warrants to the original purchaser of this product that it is free from defects in material and workmanship as described in the ATTO Technology website, www.attotech.com. Manufacturer liability shall be limited to replacing or repairing, at its option, any defective product. There is no charge for parts or labor should Manufacturer determine that this product is defective.

Products which have been subject to abuse, misuse, alteration, neglected, or have been serviced, repaired or installed by unauthorized personnel shall not be covered under this warranty provision. Damage resulting from incorrect connection or an inappropriate application of this product shall not be the responsibility of Manufacturer. Manufacturer's liability is limited to Manufacturer's product(s); damage to other equipment connected to Manufacturer's product(s) is the customer's responsibility.

This warranty is made in lieu of any other warranty, express or implied. Manufacturer disclaims any implied warranties of merchantability or fitness for a particular purpose. Manufacturer's responsibility to repair or replace a defective product is the sole and exclusive remedy provided to the customer for breach of this warranty. Manufacturer is not liable for any indirect, special, incidental, or consequential damages irrespective of whether Manufacturer has advance notice of the possibility of such damages. No Manufacturer dealer, agent or employee is authorized to make any modification, extension or addition to this warranty.

Contact ATTO Technology, Inc.

Customer service, sales and technical support are available by phone Monday through Friday, 8 a.m. to 5 p.m EST., or by fax and web site 24-hours a day.

ATTO Technology, Inc.
155 CrossPoint Parkway
Amherst, New York 14068
(716) 691-1999 • voice
(716) 691-9353 • fax
www.attotech.com

ATTO Technology can also be reached via e-mail at the following addresses:

Sales Support: sls@attotech.com
Technical Support: techsupp@attotech.com

