

ViewSonic®

Pocket PC V37



User Guide



Table of Contents

Product Registration	v
For Your Records	v

Getting Started

Package Contents	1
Accessories	1
QUICK START	2
1 Identifying Components	2
2 Setting the Battery Switch	3
3 Charging the Battery	3
4 Starting Your V37	4
5 Installing Microsoft ActiveSync	4
Register Your Product	6
For More Information	6
Hardware Features	7
Front Components	7
Rear Components	8
Left-Side Components	9
Top Components	10
Bottom Components	10
V37 USB Cradle	11
Battery Charging Options	12
SD Memory and SDIO Capabilities	13

Basic Skills

Using the Stylus	15
Today Screen	16
Status Icons	17
Navigation Bar and Command Bar	18
Running Programs	19
Pop-up Menus	20
Notifications	20
Entering Information	21
Entering Text Using the Input Panel	21
Writing on the Screen	24

Drawing on the Screen	27
Recording a Message	28
Using My Text	29

Managing Your V37

Managing Power	31
Power-Saving Tips	31
Managing Memory	32
Storage and Program Memory	32
Memory Cards	32
SDRAM Memory Allocation	32
Finding and Organizing Information	34
Customizing Your V37	35
Setting a Password	36
Adding or Removing Programs	36
Adding Programs	36
Removing Programs	36
Backing Up Data	37
Using Backup	37

Microsoft ActiveSync

Using Microsoft ActiveSync	39
Synchronizing Data	40
Connecting to Your PC	41
Connecting by USB Cable	41
Connecting by Infrared	41

Pocket Outlook

Scheduling Appointments/Meetings	43
Creating an Appointment	44
Using the Summary Screen	45
Creating Meeting Requests	45
Managing Contacts	46
Finding a Contact	47
Using the Summary Screen	48
Tasks: Keeping a To Do List	49
Creating a Task	50
Using the Summary Screen	51
Notes: Capturing Thoughts and Ideas	52

Creating a Note	52
Inbox: Sending and Receiving Email	53
Synchronizing Email Messages	53
Using the Message List	53
Managing Email Messages and Folders	55

Companion Programs

Pocket Word	57
Using Pocket Word	57
Tips for Working in Pocket Word	58
Pocket Excel	58
Tips for Working in Pocket Excel	58
Windows Media Player for Pocket PC	59
Microsoft Reader	60
Getting Books onto Your V37	60
Using the Library	61
Reading a Book	62
Using Reader Features	62
Removing a Book	63
Other Programs	64

Pocket Internet Explorer

Using Pocket Internet Explorer	65
Viewing Mobile Favorites and Channels	66
Browsing the Internet	66
The Mobile Favorites Folder	66
Favorite Links	67
Mobile Favorites	67
Conserving Memory	67
Using AvantGo Channels	68

Getting Connected

Connecting to a Network or the Internet	69
Creating a Wireless Connection to a Network	69
Creating a Wireless Connection to the Internet	70
Using an Infrared Connection	70

Troubleshooting and Maintenance

Resetting your V37	71
--------------------------	----

Restoring Factory Defaults	72
Power Problems	73
Memory Problems	74
Screen Problems	75
V37Connection Problems	75
USB Cradle Connection Problems	75
Network Connection Problems	76
Infrared Connection Problems	76
Care and Maintenance	77
General Guidelines	77
Travel Guidelines	77
Customer Support	78

Appendix

Regulatory and Safety Information	79
Class B Regulations	79
European Regulatory Notice	80
Battery Replacement	80
About the AC Adapter	81
About Electrostatic Discharge	81
Limited Warranty	82
Specifications	83
Data Loss Disclaimer	84

Copyright © ViewSonic Corporation, 2003. All rights reserved.

ViewSonic and the three birds logo are registered trademarks of ViewSonic Corporation.

Microsoft, Windows, the Microsoft Internet Explorer logo graphic, ActiveSync, PowerPoint, Outlook, DirectX, DirectSound, Pocket Word, MSN, Pocket Excel, Pocket Internet Explorer, Microsoft Exchange, Visual Solutions, and the Windows logo are either registered trademarks or trademarks of Microsoft Corporation in the United States and/or other countries. ClearVue is a trademark of the Westtek Corporation.

Corporate names and trademarks are the property of their respective companies.

Disclaimer: ViewSonic Corporation shall not be liable for technical or editorial errors or omissions contained herein; nor for incidental or consequential damages resulting from furnishing this material, or the performance or use of this product.

In the interest of continuing product improvement, ViewSonic Corporation reserves the right to change product specifications without notice. Information in this document may change without notice.

No part of this document may be copied, reproduced, or transmitted by any means, for any purpose without prior written permission from ViewSonic Corporation.

Product Registration

To meet your future needs, and to receive any additional product information as it becomes available, please register your product on the Internet at: **www.viewsonic.com**.

For Your Records

Product Name:	ViewSonic Pocket PC V37
Model Number:	VSMW27026-1
Document Number:	A-CD-PPCV37-UG
Serial Number:	_____
Purchase Date:	_____

1 Getting Started

Congratulations on your purchase of the ViewSonic Pocket PC V37. The V37 is a Windows® Powered Pocket PC that enables you to keep your most important business and personal information up-to-date and close at hand. Microsoft ActiveSync increases the power of your device by allowing you to synchronize information on your desktop or laptop computer with your V37.

This chapter introduces you to the internal and external components of the ViewSonic Pocket PC V37.

Package Contents

When you unpack the contents of the Pocket PC V37, verify that you have all of the items listed below.

- ViewSonic Pocket PC V37
- Stylus
- AC adapter
- USB cradle
- SD dummy card (inside the slot)
- Carrying case
- ViewSonic Pocket PC V37 Companion CD (contains Microsoft ActiveSync®, Microsoft Outlook 2000, ClearVue Image, ClearVue Presentation, and the V37 User Guide in PDF format)
- Visual Solutions™ Developer Tools CD (contains Microsoft Visual Solutions utilities and documentation)
- User Guide

Accessories

You can expand your V37's capabilities or replace lost parts by purchasing accessories. Go to **www.viewsonic.com** for information about V37 accessories.

QUICK START

Using the V37 for the first time

1 Identifying Components

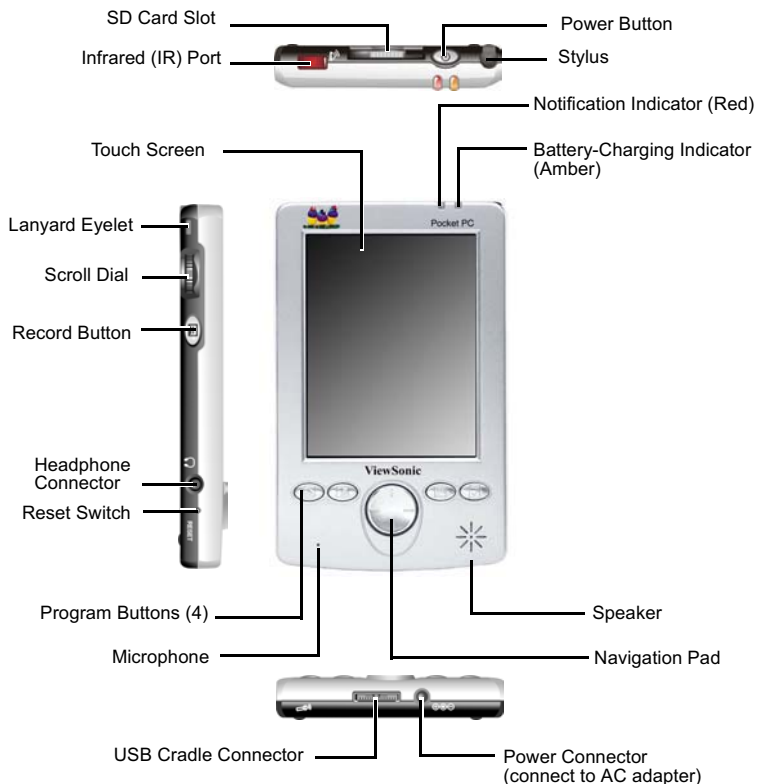

2 Setting the Battery Switch

The switch on the back of your Pocket PC V37 should be switched to the ON (down) position. If this is not the case, please set it to ON.

- 1 Make sure that the V37 is turned off.
- 2 Unscrew the cap at the top of the stylus. Use the pointed tip of the cap to slide the battery switch to the ON (down) position.
- 3 The Notification indicator will flash red for approximately 30 seconds, and then your V37 will automatically turn on and display the Welcome Wizard screen.



IMPORTANT: Keep the battery switch set to ON (down position) unless you need to restore factory defaults.

3 Charging the Battery

Connect your V37 to an AC power source.

- 1 Plug the V37 into the USB cradle.

NOTE: You can also connect the V37 directly to the AC adapter without using the USB cradle. For more information see "Battery Charging Options" in this chapter.

- 2 Plug the appropriate end of the AC adapter into the power connector on the USB cable.

NOTE: For information about battery replacement, see page 82.

- 3 Plug the other end of the AC adapter into a grounded AC outlet.



The battery-charging indicator lights amber when charging is in progress.

- 4 Fully charging may require a couple of hours. The amber battery-charging indicator turns off when the battery is fully charged.

NOTE: Whenever possible, charge the battery by connecting the V37 to an AC power source. This will keep the battery charged and prevent data loss or damage to the battery in case the battery has been kept in a discharged state for too long.

4 Starting Your V37

Press the power button to turn the V37 on.

The first time you start your V37, the Welcome Wizard screen appears. The wizard's on-screen instructions will lead you through the setup process. Follow the instructions to complete the process and begin using your V37.

5 Installing Microsoft ActiveSync

A key component of your V37 is the Microsoft ActiveSync® program. With Microsoft ActiveSync, you can synchronize the information on your PC with information on your V37 and update both with the most recent information.

ActiveSync is already installed on your V37. You need to install ActiveSync on your PC. Follow the procedure below:

IMPORTANT:

- **Before installation, make sure you have Microsoft Outlook installed on your PC. If you do not have Outlook, you can install Outlook 2000 from the provided ViewSonic Pocket PC V37 Companion CD.**
- **Do not connect your V37 to your PC before ActiveSync is installed.**

- 1 Turn on your PC.
- 2 Insert the Microsoft ActiveSync Utility CD into the CD-ROM drive of your PC. The ActiveSync installation screen should open immediately. If this does not happen, double-click **Setup.exe** and go to Step 3.
- 3 Click the arrow on the first screen to enter the main screen. Click **Start Here**, then click **Install ActiveSync 3.5**. Click **Install** to start the installation.
- 4 When prompted, connect your V37 to your PC using the USB cradle as follows:
 - (1) Place the V37 in the USB cradle.
 - (2) Connect the AC adapter to the power connector on the USB plug.
 - (3) Connect the USB cable to your PC. The **Found New Hardware Wizard** will appear.



- 5 Follow the on-screen instructions to complete the USB driver installation. The V37 will automatically connect to your PC.
- 6 Follow the on-screen instructions to synchronize the V37 with your PC.

After your first synchronization, the data you have stored on your PC, such as Calendar, Contacts, and Tasks, is copied to your V37. You're now ready to take it along with you when you go.

For more information on ActiveSync, see Chapter 4.

Register Your Product

Go to www.ViewSonic.com to register your V37. You will need to know the serial number of your V37 (see the back of the V37). To help with identification in the event of theft or loss, keep this User Guide as a permanent record of your purchase.

For More Information

For information on:	See this source
Complete information for operating the V37	V37 User Guide (In addition to the paper version, the User Guide is also available as a PDF file on the ViewSonic Pocket PC V37 Companion CD.)
Programs on your Pocket PC	V37 User Guide or ActiveSync Help on your PC.
Additional programs that can be installed on your Pocket PC	ViewSonic Pocket PC V37 Companion CD
Connecting to and synchronizing with a PC	V37 User Guide or online Help. Tap Help on the Start menu to view Help.
ViewSonic Customer Support	Chapter 9 of the V37 User Guide
Troubleshooting	V37 User Guide
Last-minute updates and technical information	The Read Me files in the "Microsoft ActiveSync" folder on your PC or the ViewSonic Pocket PC V37 Companion CD
The latest on Windows Powered Pocket PCs	The Microsoft Mobile Devices Web site: www.microsoft.com/mobile/pocketpc

Hardware Features

The illustrations below introduce you to the various buttons, connectors, ports, and other features of your V37.

Front Components



Ref	Component	Description
1	Touch Screen	Selects menu commands or input text.
2	Program Buttons	Provides a quick way to run a specific program. By default, they are Notes , Calendar , Contact , and Tasks buttons (left to right).
3	Microphone	Receives sound and voice to record voice notes.
4	Navigation Pad	Move up, down, left, or right in a document.
5	Speaker	Sends out music or audible reminders and alerts.
6	Battery Charge Indicator	Glowes amber when battery is being charged and turns Off when battery is fully charged.
7	Notification Indicator	Informs you about scheduled appointments, alarms, reminders, and voice recording status.

Rear Components



Ref	Component	Description
1	Battery Switch	Restores your V37 to the factory default settings and clears all data stored in RAM. NOTE: Always leave the switch in the ON (down) position unless you need to perform a hard reset.

Left-Side Components



Ref	Component	Description
1	Lanyard Eyelet	Lanyard attaches to this opening.
2	Scroll Dial	Selects the highlighted item, or scrolls up or down in a document.
3	Record Button	Record voice notes by pressing and holding this button.
4	Stereo Headphone Connector	Connects stereo headphones.
5	Reset Switch	Restarts your V37 NOTE: Unscrew the rear cap of the stylus and use the pointed end of the cap to reset the V37.

Top Components

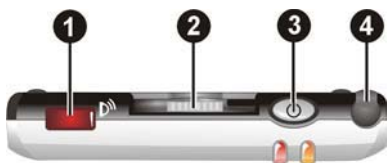

Ref	Component	Description
①	IR Port	Beams files to or from other mobile devices using infrared (IR).
②	SD Memory/SDIO Card Slot	Accepts an optional Secure Digital card for extended memory capacity or an <i>SDIO Now!</i> compatible 802.11b (WiFi) card.
③	Power Button	Turns your V37 On or Off, or turns the backlight On or Off by pressing and holding this button.
④	Stylus Slot	Stores the stylus when it is not in use.

Bottom Components

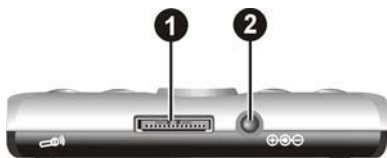

Ref	Component	Description
①	Cradle Connector	Connects the V37 to the USB cradle to charge the battery and to synchronize the V37 with your PC.
②	Power Connector	Connects the V37 to the AC adapter when not using the USB cradle.

V37 USB Cradle

The USB cradle provides a convenient way to charge your V37 and connect your V37 to a PC through a USB connection.



Ref	Component	Description
①	USB Connector	Connects to your PC for data synchronization.
②	Power Connector	Connects to the DC plug of the AC adapter.
③	Pocket PC Connector	Connects to your Pocket PC V37.
④	AC adapter	Connects to an AC outlet.

Battery Charging Options

With the cradle

- 1 Slide your V37 into the cradle.
- 2 Plug the appropriate end of the AC adapter into the power connector on the USB.
- 3 Plug the other end of the AC adapter into an AC outlet.



Without the cradle

Connect the DC plug from the AC adapter to the power connector on the bottom of the V37, and plug the AC adapter into an AC outlet.

The battery-charger indicator lights amber when charging is taking place.



- Allow the battery to become fully charged (about two hours). The amber Battery Charge Indicator turns off when the battery is fully charged.

Whenever possible, charge the battery by connecting your V37 to an AC power source. This will keep the battery charged and prevent data loss or damage to the battery in case the battery has been kept in a discharged state for too long.

SD Memory and SDIO Capabilities

Your V37 has an SDIO card slot which accepts an SD (Secure Digital) memory card and **SDIO Now!** (Secure Digital Input/Output) compatible cards. You can purchase an SD card to expand the memory capacity and capabilities of your V37. Currently, you can also purchase an 802.11B (WiFi) card that supports the **SDIO Now!** technology, and other peripherals may be available in the future.

NOTE: Make sure your SDIO card is compatible with **SDIO Now!** technology, developed by bSquare Inc.

To insert an SD memory card or SDIO card:

- 1 Slide the end of the card with the chipped corner into the SDIO slot (with the label side and the V37's front panel facing you).
- 2 Push the card into the slot until it clicks into place.

To remove an SD memory card or SDIO card:

- Press the card. When the card pops out slightly, you can remove it.

2 PanelBasic Skills

This chapter introduces you to the basics of working with programs and documents on your V37.

Using the Stylus

Use the stylus to navigate and select objects on the V37 touch-screen.

NOTE: You can extend the stylus to hold it more comfortably.

- **Tap:** Touch the screen once with the stylus to open items and select options.
- **Drag:** Hold the stylus on the screen and drag across the screen to select text and images. Drag in a list to select multiple items.
- **Press and hold:** Press and hold the stylus on an item to see a list of actions available for that item. On the pop-up menu that appears, tap the action you want to perform.



Today Screen

When you turn on your V37 for the first time each day (or after 4 hours of inactivity), you will see the Today screen. On the Today screen, you can see at a glance important information for the day.



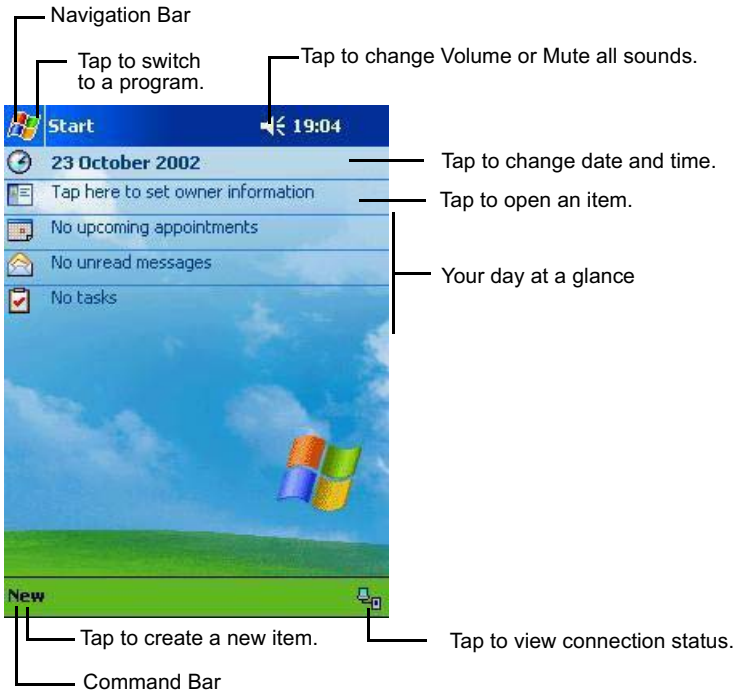



You can also display the Today screen by tapping  and then tapping **Today**.



Status Icons

When the Today screen is displayed, you may see the following status icons on the Command bar or Navigation bar. In most cases, you can tap a status icon to display the associated control panel or more information related to the item.

For example, tap  to see information about the battery status.

Icon	Meaning
	Speaker is On.
	Speaker is Off.
	Main battery is low.
	Main battery is very low.
	Main battery is fully charged.
	Synchronization is beginning or ending.

Navigation Bar and Command Bar

The Navigation bar is located at the top of the screen. It displays the active program and current time, and allows you to switch programs and close screens.

The Navigation bar and Start menu:

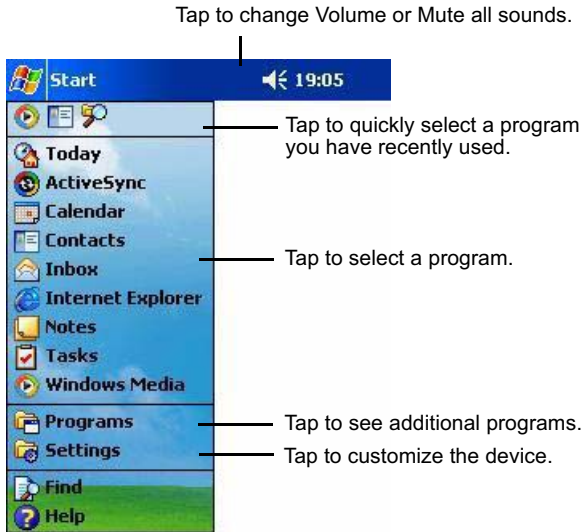

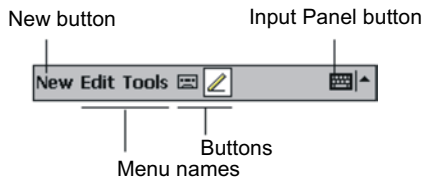

Use the Command bar at the bottom of the screen to perform tasks in programs. The Command bar includes menu names, buttons, and the Input Panel button. To create a new item in the current program, tap **New**. To see the name of a button, press and hold the stylus on the button. Drag the stylus off the button so that the command is not carried out.

The Command bar:











Running Programs

Depending on the program you want to run, you can:

- Tap  or tap **Start** at the top of the screen and select from the menu. (You can customize which programs you see on this menu. For information, see section "Customizing Your V37" in Chapter 3).
- Tap  and then tap **Programs** to access additional programs. Tap the icon to run the program.
- Press program buttons on the front of your V37 to open the program. The icons on the buttons identify the programs they are associated with. (You can customize which programs are associated with the buttons. For information, see the section "Customizing Your V37" in Chapter 3).

The following table contains a partial list of the program icons on your V37.

Icon	Program	Description
	ActiveSync	Synchronize information between your V37 and PC.
	Calendar	Keep track of your appointments and create meeting requests.
	Contacts	Keep track of your friends and colleagues.
	Inbox	Send and receive email messages.
	Pocket Internet Explorer	Browse Web and WAP (Wide Area Protocol) sites, and download new programs and files from the Internet.
	Notes	Create handwritten or typed notes, drawings, and recordings.
	Tasks	Keep track of your tasks.
	Pocket Excel	Create new workbooks or view and edit Excel workbooks created on your PC.
	Pocket Word	Create new documents or view and edit Word documents created on your PC.

Pop-up Menus

With pop-up menus, you can quickly choose an action for an item. For example, you can use the pop-up menu in the contact list to quickly delete a contact, make a copy of a contact, or send an email message to a contact. The actions in the pop-up menu vary from program to program. To access a pop-up menu, press and hold the stylus on the name of the item that you want to perform the action on.

When the menu appears, lift the stylus, then tap the action you want to perform. Or tap anywhere outside the menu to close the menu without performing an action.

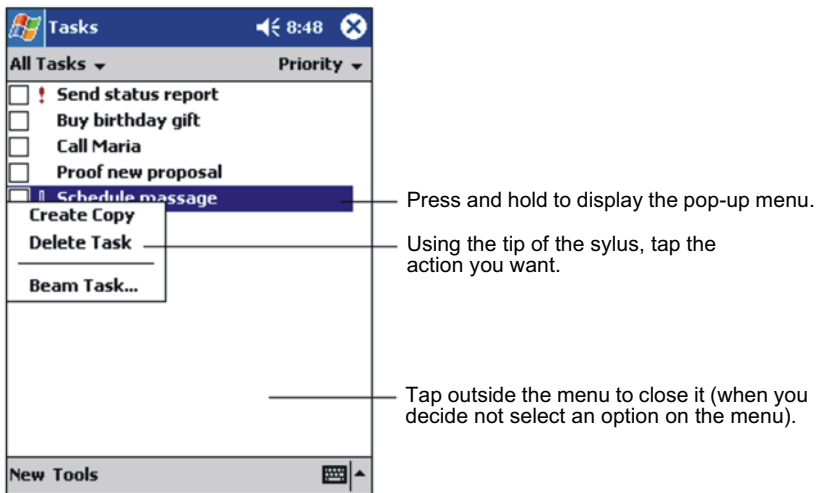

Notifications

Your V37 reminds you in a variety of ways when you have something to do. For example, if you have set up an appointment in Calendar, a task with a due date in Tasks, or an alarm in Clock, you will be notified in any of the following ways:

- A message appears on the screen.
- A sound, which you can specify, is played.
- The notification LED flashes.

To choose reminder types and sounds for your V37, tap **Settings** on the **Start** menu. On the **Personal** tab, tap **Sounds & Notifications**.

Entering Information

You have several options for entering new information:

- Use the Input Panel to enter typed text, either by using the soft (on-screen) keyboard or other input methods.
- Write directly on the screen.
- Draw pictures on the screen.
- Speak into the microphone to record a message. For more information on using the microphone, see the section on "Recording a Message".

Entering Text Using the Input Panel

Use the Input Panel to enter information in any program on your V37.

You can either type using the soft (on-screen) keyboard or write using the Block Recognizer or Letter Recognizer. In any case, the characters appear as typed text on the screen.

To show or hide the Input Panel, tap the **Input Panel** button. Tap the arrow next to the Input Panel button to see your choices.

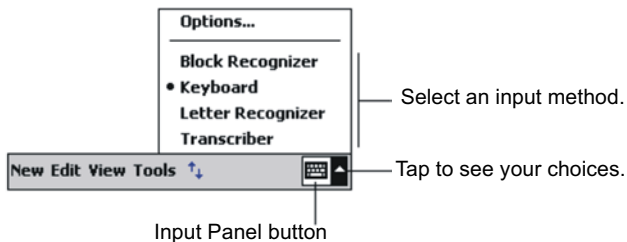

When you use the Input Panel, your V37 anticipates the word you are typing or writing and displays it above the Input Panel. When you tap the displayed word,

it is inserted into your text at the insertion point. The more you use your V37, the more words it learns to anticipate.

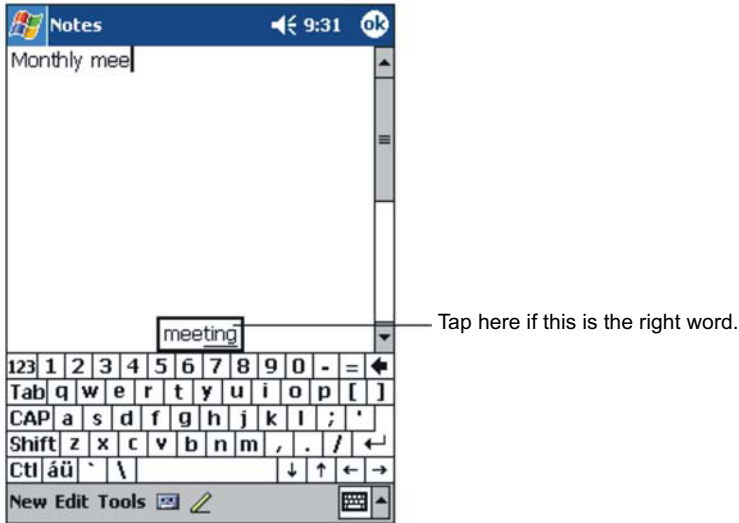

NOTE: To change word suggestion options, such as the number of words suggested at one time, tap **Setting** on the **Start** menu. On the **Personal** tab, tap **Input**, then tap the **Word Completion** tab.

Block Recognizer

With Block Recognizer, you can use the stylus to input characters and words.

To type with Block Recognizer:

- 1 Tap the arrow next to the Input Panel button, and then tap **Block Recognizer**.
- 2 Write a letter in the box.

When you write a letter, it is converted to typed text that appears on the screen. For specific instructions on using Block Recognizer, open Block Recognizer, and then tap the question mark (?) next to the writing area.

Soft Keyboard

The Soft Keyboard is an on-screen keyboard displayed at the bottom of the screen.

To type with the soft keyboard:

- 1 Tap the arrow next to the Input Panel button, and then tap **Keyboard**.
- 2 On the keyboard that is displayed, tap the keys with your stylus.

Letter Recognizer

With Letter Recognizer, you can write letters using the stylus just as you would use a pen on paper.

To type with Letter Recognizer:

- 1 Tap the arrow next to the Input Panel button, and then tap **Letter Recognizer**.
- 2 Write a letter in the box.

When you write a letter, it is converted to typed text that appears on the screen. For specific instructions on using Letter Recognizer, open Letter Recognizer and then tap the question mark next to the writing area.

Transcriber

With Transcriber you can write anywhere on the screen using the stylus just as you would on paper. Unlike Letter Recognizer and Block Recognizer, you can write a sentence or more of information; then, you pause and let Transcriber change the written characters to typed characters.

To type with Transcriber:

- 1 Tap the arrow next to the Input Panel button, and then tap **Transcriber**.
- 2 Write anywhere on the screen.

For specific instructions on using Transcriber, open Transcriber and then tap the question mark in the lower-right corner of the screen.

Writing on the Screen

In any program that accepts writing—such as the Notes program and the **Notes** tab in Calendar, Contacts, and Tasks—you can use your stylus to write directly on the screen. Write the way you do on paper. You can edit and format what you have written and convert the information to text later.

To write on the screen, tap the **Pen** button to switch from tapping to writing mode. This action displays lines on the screen to help you write.

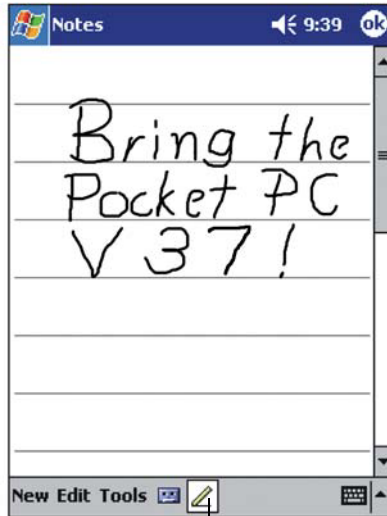

Tap the Pen button and use your stylus like a pen.

Some programs that accept writing may not have the Pen button. See the documentation for that program to find out how to switch to writing mode.

If you want to edit or format writing, you must select it first.

To select writing:

- 1 Press and hold the stylus next to the text you want to select until the insertion point appears.
- 2 Without lifting, drag the stylus across the text you want to select.

If you write accidentally on the screen, tap **Tools**, then **Undo**, and try again. You can also select text by tapping the **Pen** button to deselect it and then dragging the stylus across the screen.

You can cut, copy, and paste written text in the same way you work with typed text: press and hold the stylus on the selected words and then tap an editing command on the pop-up menu, or tap the command on the **Edit** menu.

To convert writing to text, tap **Recognize** on the **Tools** menu.

If you want to convert only certain words, select them before tapping **Recognize** on the **Tools** menu (or press and hold the selected words and then tap **Recognize** on the pop-up menu). If a word is not recognized, it is left as writing.

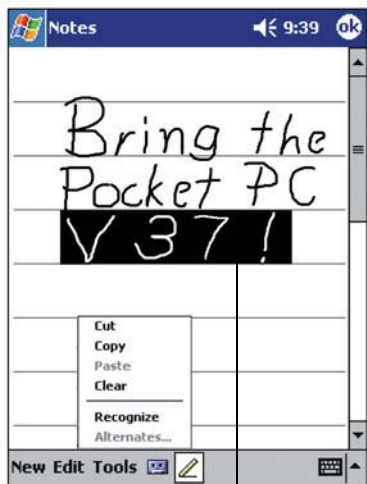

Select the text you want to convert and tap **Recognize** on the Pop-up menu.

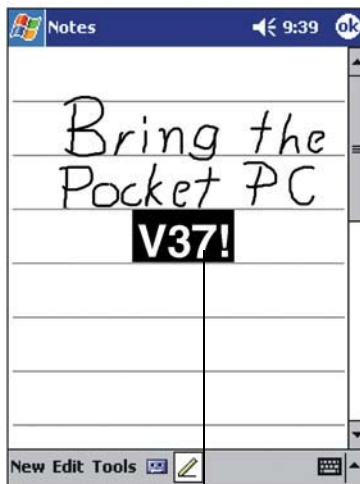

Your handwriting is turned into text.

If the conversion is incorrect, you can select different words from a list of alternates or return to the original writing. To do so, press and hold the incorrect word (tap one word at a time). On the pop-up menu, tap **Alternates**.

A menu with a list of alternate words appears. Tap the word you want to use, or tap the writing at the top of the menu to return to the original writing.

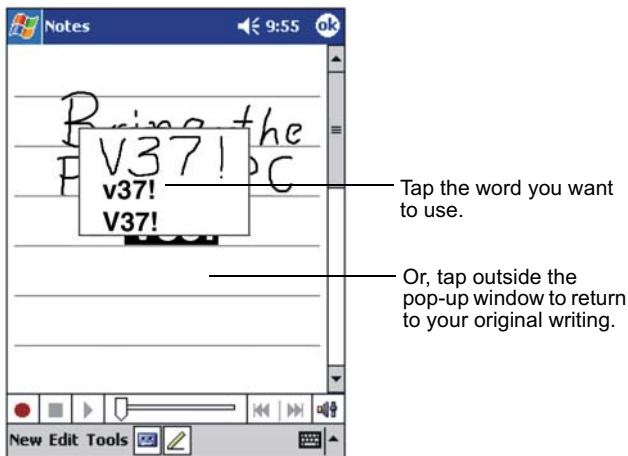

Some tips for getting good recognition are listed below:

- Write on the lines and draw descenders below the line. Write the cross of the "t" and apostrophes below the top line so that they are not confused with the word above. Write periods and commas above the line.

For better recognition, use the **Tools** menu to increase the zoom level to 300%.

- Write the letters of a word close together and leave big gaps between words.
- Hyphenated words, foreign words that use special characters such as accents, and some punctuation cannot be converted.
- If you add writing to a word to change it (such as changing a "3" to an "8") after you attempt to recognize the word, the writing you add will not be included if you attempt to recognize the writing again.

Drawing on the Screen

You can draw on the screen in the same way that you write on the screen. The difference between writing and drawing on the screen is how you select items and how they can be edited. For example, selected drawings can be resized, while writing cannot.

To create a drawing, cross three ruled lines on your first stroke. A drawing box appears. Drawings that do not cross three ruled lines will be treated as writing.

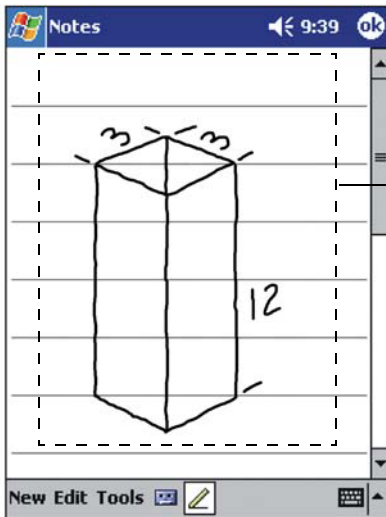

The drawing box indicates the boundaries of the drawing.

You may want to change the zoom level so that you can more easily work on or view your drawing. Tap **Tools**, then choose a zoom level.

If you want to edit or format a drawing, you must select it first.

To select a drawing, press and hold the stylus on the drawing until the selection handle appears. To select multiple drawings, deselect the Pen button and then drag to select the drawings you want.

You can cut, copy, and paste selected drawings by pressing and holding the selected drawing and then tapping an editing command on the pop-up menu, or by tapping the command on the **Edit** menu. To resize a drawing, make sure the Pen button is not selected, and then drag a selection handle.

Recording a Message

In any program where you can write or draw on the screen, you can also quickly capture thoughts, reminders, and phone numbers by recording a message. In Calendar, Tasks, and Contacts, you can include a recording in the **Notes** tab. In the Notes program, you can either create a stand-alone recording or include a recording in a written note. If you want to include the recording in a note, open the note first. In the Inbox program, you can add a recording to an email message.

To create a recording:

- 1 Hold the V37's microphone about three inches from your mouth.
- 2 Press and hold the record button on the left side of the unit. If the speaker is not muted, a beep indicates that your V37 is recording. The notification LED at the top of the unit glows red while recording is in progress.
- 3 While holding down the record button, speak into the microphone.
- 4 To stop recording, release the record button. Two beeps will sound. The new recording appears in the note list or as an embedded icon.

NOTE: You can also make a recording by tapping the **Record** button on the Recording toolbar.

To play a recording:

- Tap it in the list or tap its icon in the note.

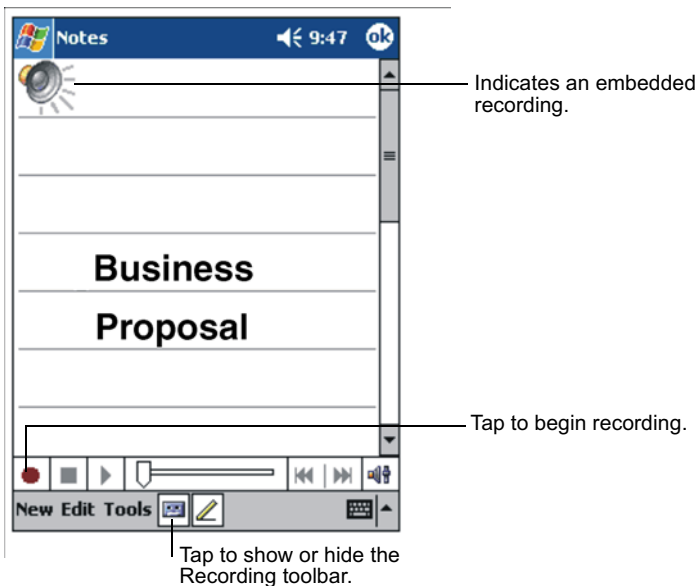

Recording Formats

Your V37 supports several formats for voice notes. The formats vary in both the quality of the recording and the size of the sound file. When selecting a recording format, you should consider the quality you need as well as how much storage memory the recording will use on your V37.

Not all recording formats are compatible with other software or computers. If you will share your recordings with others or transfer a recording to your PC, be sure to choose a recording format that is supported by the software used to play recordings on the other computer.

To select a recording format:

- 1 On the **Start** menu, tap **Settings**, and then tap the **Input** icon.
- 2 On the **Options** tab in the Input control panel, select a voice recording format from the drop-down list.

The list of recording formats on your V37 indicates the sample rate, whether the format is stereo or mono, and how much storage memory is required per second of recording. You may need to experiment with different sample rates and formats to determine which format best suits your voice.

Using My Text

When using Inbox, use My Text to quickly insert preset or frequently used messages into the text entry area. To insert a message, tap **My Text**, and then tap a message.

NOTE: After inserting a My Text message, you can add text to it before you send the message.

To edit a My Text message, on the **Tools** menu, tap **Edit My Text Messages**. Select the message you wish to edit and make desired changes.

3 Managing Your V37

This chapter tells you how to effectively manage power and memory, and how to add/remove programs and back up your data.

Managing Power

It is important to maintain a continuous power supply to the V37 to prevent data or files stored in RAM from being damaged. Your V37 can operate either on external AC power or internal battery power. Note that you will lose any information, programs or settings that you have added if the battery completely runs out of power.

A fully charged battery should provide power for up to 8 hours of use. The operating time of a fully charged battery depends on how you are using the V37. Using some functions, such as some of the multimedia features or a Secure Digital card, may consume extra battery power.

You should recharge the battery when a warning of low power is displayed on your V37, or the V37 will turn off automatically. You will need to connect the V37 to external AC power for charging before you can use it again.

See Chapter 1 for information about powering on your V37.

To check the remaining power:

- 1 On the **Start** menu, tap **Settings**.
- 2 On the **System** tab, tap the **Power** icon.

The remaining power is displayed on a status bar in the Power control panel.

Power-Saving Tips

Follow these suggestions to maximize the battery's operating time:

- **Turn off the backlight.** Press and hold the power button to turn off the backlight, or use the Backlight control panel to set the backlight to turn off automatically after a short period of inactivity.

- **Suspend frequently.** Use the Power control panel to shorten the length of continuous idle time before your V37 auto-suspends. Press the power button to turn off your V37 when it is not in use, even for a short time.
- **Always use AC power when connecting your V37 to your PC.** Note that your V37 will not auto-suspend while it is connected.
- **Turn off sounds.** Use the Sounds & Notifications control panel to turn off all but the most necessary system sounds.
- **Avoid using memory card accessories while on battery power.** Some memory cards use considerable power and will quickly drain your battery.
- **Do not "listen" for infrared transfers.** Although you can set your Pocket PC to constantly monitor the IR port for files sent from other devices, doing so will quickly drain your batteries.

Managing Memory

Your V37 uses two kinds of memory: storage and program memory (RAM), and optional memory cards.

Storage and Program Memory

RAM (Random Access Memory) on your V37 is shared between storage memory and program memory. "Storage memory" is used to store the data you create and additional programs you install. "Program memory" is used to run programs on your V37. Your V37 automatically manages the allocation between storage and program memory. However, in some situations, such as when the memory is running out, your V37 may not be able to automatically adjust the allocation.

Memory Cards

Memory cards are small, removable flash storage cards that enable you to expand the memory of your V37. You can use memory cards for backup storage, archives, or to transfer large files to other devices. Your V37 supports Secure Digital memory cards. Memory cards can be purchased from a variety of third-party vendors.

SDRAM Memory Allocation

The V37 has 64 MB of SDRAM memory:

- For the USA and European models: 27.5 MB is used by the Pocket PC 2002 Operating System, applications, and drivers.
For the Asian models: 35.5 MB is used by the Pocket PC 2002 Operating System, applications, and drivers.
- The remaining memory is available for user applications and file storage: 36.5MB for the USA and Europe V37 models and 28.5MB for the Asian V37 models.

Memory Map for 64MB SDRAM:

Description	USA and European Models	Asian Models
Flash ROM Image allocated for Pocket PC 2002 Operating System and applications	24.0 MB	32.0 MB
Drivers	3.5 MB	3.5 MB
Available for user applications and file storage	36.5 MB	28.5 MB
Total Memory	64.0 MB	64.0 MB

NOTE: The USA and European V37 models have an additional 36 MB of Flash ROM memory available for file storage called "My Flash Disk."

The Asian V37 models have an additional 31 MB of Flash ROM memory available for file storage. This additional Flash ROM is smaller because the Asian operating systems require more space.

Finding and Organizing Information

The Find feature on your V37 helps you quickly locate information.

To find a file, on the **Start** menu, tap **Find**. Enter the text you want to find, select a data type, and then tap **Go** to start the search.

NOTE: To quickly find information that is taking up storage space on your V37, select **Larger than 64KB** under **Type**.

You can also use the File Explorer to find files on your V37 and to organize these files into folders. On the **Start** menu, tap **Programs**, and then tap **File Explorer**.

Tap to change folders.

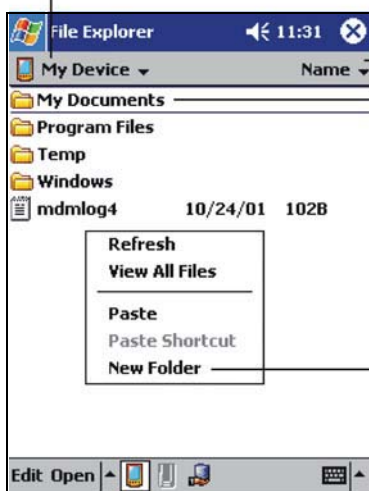

Select the sort order for the list.

Tap the folder name to open it.

Press and hold to create a new folder.

Customizing Your V37

You can customize the settings of the V37 to your own preferences.

Tap **Start**, then tap **Settings**. You can tap any of the icons on the **Personal**, **System**, or **Connections** tabs to customize your V37. The customization options are as follows:

	Options	Description
PERSONAL	Buttons	Assigns your favorite programs to the program buttons, and sets the repeat rate of the scroll dial.
	Input	Sets the settings related to Block Recognizer, soft keyboard, Letter Recognizer and Transcriber input methods.
	Menus	Selects the items that appear on the Start menu and the New menu on the Today screen.
	Owner Information	Saves your personal information.
	Password	Sets the password to your V37 to protect the stored data.
	Sounds & Notifications	Sets the conditions and types of the sounds, system volume, and ways of notifications.
	Today	Sets the items that appear on the Today screen.
SYSTEM	About	Shows information about the version of the operating system, the name of the Pocket PC, and copyrights.
	Backlight	Adjusts the backlight of the display.
	Clock	Sets the current time and alarm.
	Memory	Adjusts the allocation of data and program storage.
	Power	Shows the remaining battery and external AC power, and set the time for the V37 to turn off automatically.
	Regional Settings	Sets the region of your location, and formats for number, currency, time and date.
	Remove Programs	Removes programs pre-installed in RAM.
	Screen	Realigns the touch screen for accurate taps.

Setting a Password

A password can safeguard your V37 against unauthorized use. To set your password:

- 1 Tap **Start**, tap **Settings**, then tap the **Password** icon on the **Password** tab.
- 2 Tap the digits or characters to set your password. You can set a four-digit password, or a long password containing a combination of at least seven characters, digits or punctuation.
- 3 You can set the time for the V37 to prompt for a password after idling.
- 4 Tap **OK**.

Adding or Removing Programs

Adding Programs

You can add even more functionality to your V37 by installing additional software and programs. A wide variety of software is available for Windows Powered Pocket PCs, ranging from custom business applications and system utilities to games and entertainment. Some programs are available from software vendors or on the Web.

Install only programs designed specifically to run on a Pocket PC personal digital assistant and/or a Windows Powered Pocket PC. You cannot run programs designed for Windows on your V37. In addition, you may need a version of the program designed specifically for the X-Scale processor used by your V37.

Install software to your V37 by first loading the installation files onto your PC. Use ActiveSync on your PC to transfer and install programs to the storage memory (RAM) in your V37.

Removing Programs

To free storage memory on your V37, you can remove programs you no longer use. Only programs that are stored in RAM can be removed.

Programs pre-installed in Flash ROM cannot be removed; however, these programs do not use storage memory.

To remove a program:

- 1 On the **Start** menu, tap **Settings**.
- 2 On the **System** tab, tap **Remove Programs**.
- 3 Select the program in the list, and then tap **Remove**.

NOTE: If the program does not appear in the list of installed programs, use File Explorer on your V37. Locate the program, press and hold the stylus on the program, and then tap **Delete** on the pop-up menu.

Backing Up Data

To prevent loss of data, you should back up your V37 frequently. Your V37 comes with two programs for backing up data:

- **Microsoft ActiveSync.** ActiveSync enables you to back up data to your PC. You can back up all data on your V37, or only your PIM databases (Calendar, Contacts, and Tasks). You can set ActiveSync to back up automatically each time you connect, or you can back up manually, whenever you choose. For more information, see ActiveSync Help on your PC.
- **Backup.** Backup enables you to back up all data stored in the internal (RAM) memory on your V37. You can save the backup file on an optional Secure Digital memory card.

Using Backup

Backup gives you added flexibility in backing up your valuable data. With Backup, you can back up all data in RAM. You can save the backup file to an optional SD memory card, so you can safeguard your data even while you are traveling or away from your PC.

NOTE: An internal storage device called "My Flash Disk" is included. When using Backup, you can choose this disk as your target backup device.

Backing up data using Backup

- 1 Close all running applications and insert a memory card.
- 2 Disconnect your V37 from your PC.
- 3 On the **Start** menu on your V37, tap **Programs** and then tap the **Backup** icon.
- 4 Tap **Backup**, then tap **Next**.
- 5 Tap your preference of storage media for backing up your data, then tap **Next**.
- 6 Tap the item you want to back up, then tap **Next**.
- 7 Tap **Backup**, then tap **Yes** to start the backup process.
- 8 Remove the memory card after the backup is complete.

CAUTION:

- **Never delete the backup file in the memory card. If the backup file is deleted, the backup data will be lost and cannot be restored.**
- **When you use the backup file to restore information, information on your V37 is replaced with the information stored in the backup file. If you have created files on your V37 since the last backup and do not want to delete these files during the restore process, move the files from your V37 to your PC--or to an optional memory card--before restoring the information.**

Restoring data using Backup

- 1 Close all running applications and insert a memory card with the backup data.
- 2 Disconnect your V37 from your PC.
- 3 On the **Start** menu tap **Programs**, then tap the **Backup** icon.
- 4 Tap **Restore**, then tap **Yes**.
- 5 Tap your preference of storage media for restoring your data, then tap **Next**.
- 6 Tap the item you want to restore, then tap **Next**.
- 7 Tap **Restore**, then tap **Yes** to start the restore process.
- 8 Remove the memory card after the restore process is complete, and reset your V37.

IMPORTANT: When you restore data, your V37 must have the same regional settings that it had when you completed the backup; otherwise, you will not be able to restore the files. To change regional settings, on the **Start** menu, tap **Settings**, and then tap the **Regional Settings** icon on the **System** tab. Select your region from the drop-down list.

4 Microsoft ActiveSync

This chapter tells you what the Microsoft ActiveSync program is and what you need to do to use it.

Using Microsoft ActiveSync

NOTE: ActiveSync is already installed on your V37. You need to install ActiveSync on your PC. (For information on installing ActiveSync, see Step 5 of the Quick Start procedure in Chapter 1, "Installing Microsoft ActiveSync.")

Microsoft ActiveSync allows you to synchronize the information on your PC with information on your V37. Synchronization compares the data on the two sides and updates both computers with the most recent information. For example, you can:



- Keep your Pocket Outlook Contacts, Calendar, and Tasks databases up-to-date by synchronizing your V37 with Microsoft Outlook data on your PC.
IMPORTANT: Outlook must be installed on your PC in order to synchronize your email data.
- Synchronize email messages in your V37 Inbox with email messages in Microsoft Outlook on your PC.
- Synchronize Microsoft Word and Microsoft Excel files between your V37 and PC. Your files will be automatically converted to the correct format.

With ActiveSync, you can also:

- Back up and restore your V37 data.
- Copy (rather than synchronize) files between your V37 and PC.
- Add and remove programs on your V37.

Synchronizing Data

Once you have created a synchronization partnership and completed the first synchronization, you can initiate synchronization from your V37. Follow this procedure:

- 1 Connect your V37 to your PC. (See "Connecting Your PC" in Chapter 1.)
- 2 On your V37, tap , and then tap **ActiveSync**.
- 3 Tap  to begin synchronization.

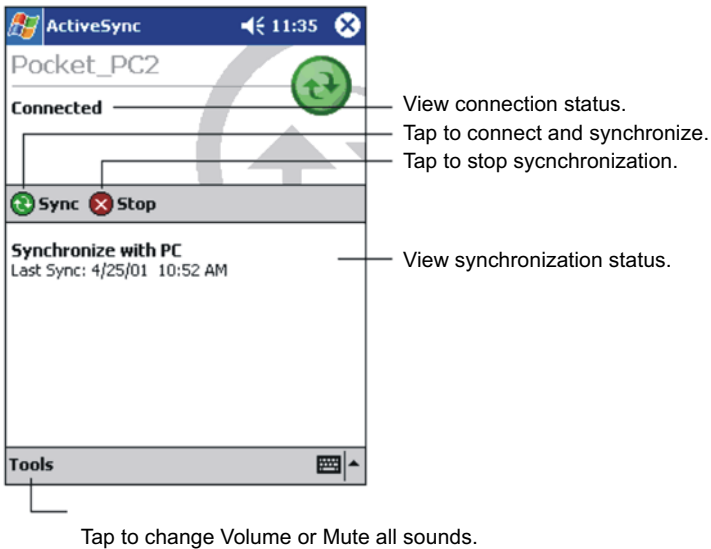

By default, ActiveSync does not automatically synchronize all types of information. Use ActiveSync options to turn synchronization on and off for specific information types. You can:

- Control when synchronization occurs by selecting a synchronization mode. For example, you can synchronize continually while the V37 is connected or only when you choose the synchronize command.
- Select which information types are synchronized and control how much data is synchronized. For example, you can choose how many weeks of past appointments you want synchronized.

For information on setting ActiveSync options and using ActiveSync on your PC, see ActiveSync Help on the PC. For information on using ActiveSync in your V37, see ActiveSync Help on the V37.

Connecting to Your PC

CAUTION: Do not shut down or restart your PC while your V37 is connected. Turn off your V37 or disconnect the USB cable before you shut down your PC.

Connecting by USB Cable

CAUTION: Before you connect your V37 to the cradle, be sure of the following: your PC is on, you have installed ActiveSync on your PC, and ActiveSync is configured to allow a USB connection.

You can keep your V37 in the cradle when you are not carrying it with you, which keeps it charged and synchronized.

For instructions on connecting, see "Installing Microsoft ActiveSync" in Chapter 1.

Connecting by Infrared

You can use the IR port to synchronize data with your PC, in place of using the cable.

IR ports can be found on many notebook computers; however, on a PC, you may need to install and configure an IR port. To install the port, follow the manufacturer's instructions.

For complete instructions on connecting to your PC by infrared, refer to ActiveSync Help on your PC.

5 Pocket Outlook

This chapter introduces you to the basics of Microsoft Pocket Outlook, including Calendar, Contacts, Tasks, Notes and Inbox.

Scheduling Appointments/Meetings

Use Calendar to schedule appointments, including meetings and other events.

You can check your appointments in one of several views (Agenda, Day, Week, Month, and Year) and easily switch views by using the **View** menu.

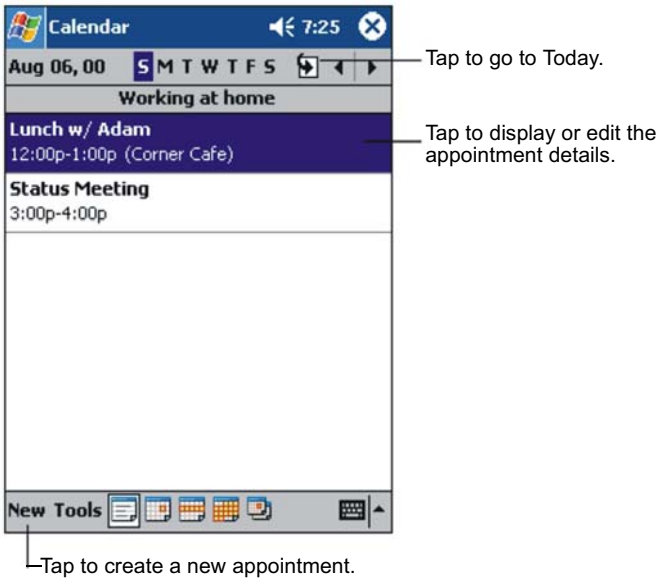

NOTE: You can customize the Calendar display (for example, change the first day of the week), by tapping **Options** on the **Tools** menu.

Creating an Appointment

- 1 In Day or Week view, tap the desired date and time for the appointment.
- 2 Tap **New**.

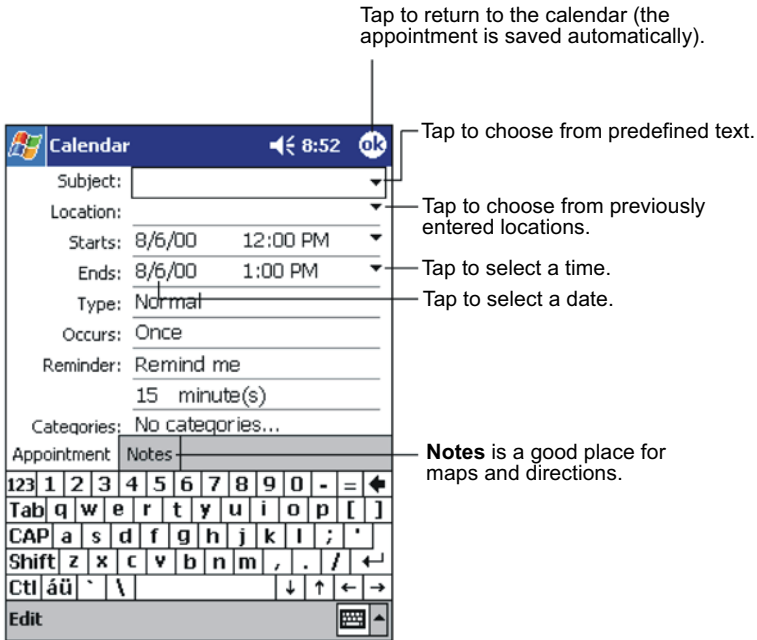

- 3 When using the Input panel, tap first to select the field, and then enter a description and a location.
- 4 If needed, tap the date and time to change them.
- 5 Enter other desired information. You will need to hide the Input panel to see all available fields.
- 6 To add notes, tap the **Notes** tab. You can enter text, draw, or create a recording. For more information on creating notes, see "Notes: Capturing Thoughts and Ideas" later in this chapter.
- 7 Tap **OK** to return to Calendar.

NOTE: If you select **Remind me** in an appointment, your V37 will remind you according to the options set in the Sounds & Notifications control panel.

Using the Summary Screen

When you tap an appointment in Calendar, a summary screen displays. To change the appointment, tap **Edit**.

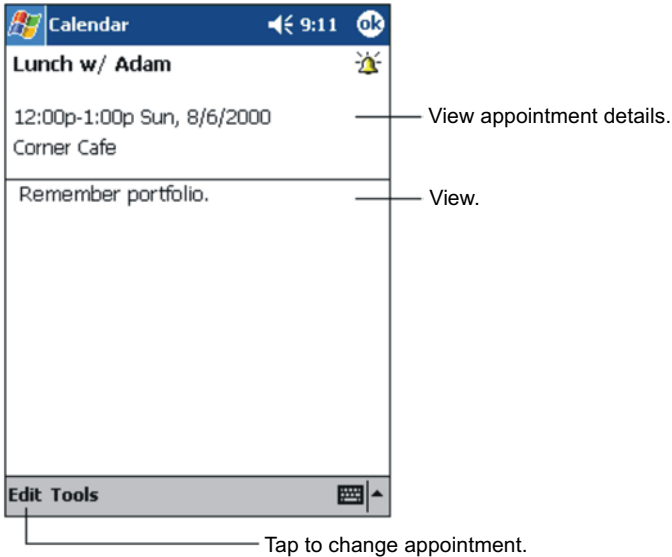

Creating Meeting Requests

You can use Calendar to set up meetings with users of Outlook or Pocket Outlook. The meeting notice will be created automatically and sent either when you synchronize Inbox or when you connect to your email server. Indicate how you want meeting requests sent by tapping **Tools** and then **Options**. If you send and receive email messages through ActiveSync, select **ActiveSync**.

To schedule a meeting:

- 1 Create an appointment.
- 2 In the appointment details, hide the Input panel, and then tap **Attendees**.
- 3 From the list of email addresses in Contacts, select the meeting attendees.

The meeting notice is created automatically and placed in the Outbox folder.

For more information on sending and receiving meeting requests, see Calendar Help and Inbox Help on your V37.

Managing Contacts

Contacts maintains a list of your friends and colleagues so that you can easily find the information you are looking for, whether you are at home or on the road. Using the IR port on the V37, you can quickly share Contacts information with users of Pocket PCs and other mobile devices.

Select the category of contacts you want to display in the list.



The screenshot shows the Contacts application interface. At the top, there is a title bar with the Windows logo, the word "Contacts", a back arrow, the time "2:06", and a close button. Below the title bar is a search bar with the text "All Contacts" and a dropdown arrow. Underneath is a keyboard-style navigation grid with letters: #, ab, cde, fgh, ijk, lmn, opq, rst, uvw, xyz. The list contains three entries: "Barr, Adam" with phone number "(206) 555-1212" and a phone icon; "Bready, Richard" with email "rich@proseware..." and an email icon; and "Brown, Jo" with phone number "(206) 555-1212" and a phone icon. A context menu is open over the "Brown, Jo" entry, listing "Create Copy", "Delete Contact", "Send E-mail to Contact...", and "Beam Contact...". At the bottom, there is a "New View Tools" bar with a small icon and an arrow.

Tap and enter part of a name to quickly find it in the list.

Tap to see additional phone numbers and e-mail addresses.

Tap to display or edit the contact details.

Press and hold to display a pop-up menu of actions.

Tap to create a new record.

NOTE: To change the way information is displayed in the list, tap **Tools** then tap **Options**.

1 Tap **New**.

Tap to return to the contact list (the contact is saved automatically).

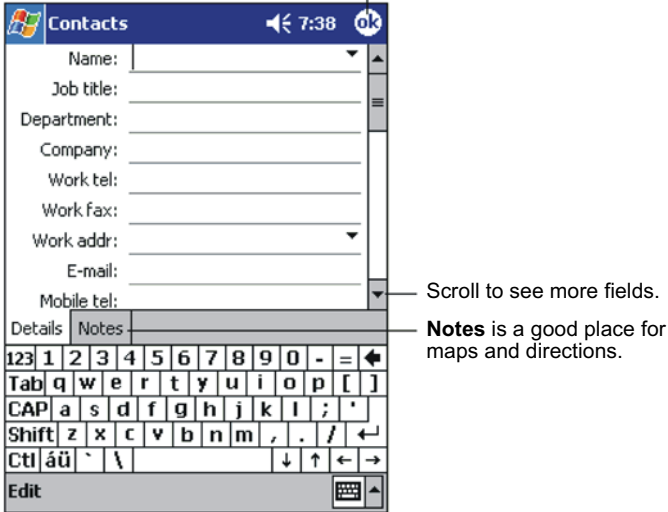

- Using the Input panel, enter a name and other contact information. You will need to scroll down to see all available fields.
- To assign the contact to a category, scroll to and tap **Categories** then select a category from the list. In the contact list, you can display contacts by category.
- To add notes, tap the **Notes** tab. You can enter text, draw, or create a recording. For more information on creating notes, see "Notes: Capturing Thoughts and Ideas" later in this chapter.
- Tap **OK** to return to the contact list.

Finding a Contact

There are four ways to find a contact:

- On the **Start** menu, tap **Find**, enter the contact name, select **Contacts** for the type, and then tap **Go**.
- In the contact list, enter a contact name in the box under the Navigation bar.

To show all contacts again, clear text from the box or tap the button to the right of the box.

- In the contact list, tap the category list (labeled **All Contacts** by default) then select the type of contact that you want displayed. To show all contacts again, select **All Contacts**. To view a contact not assigned to a category, select **None**.

- To view the names of companies your contacts work for, in the contact list, tap **View** then tap **By Company**. The number of contacts that work for that company will be displayed to the right of the company name.

Using the Summary Screen

When you tap a contact in the contact list, a summary screen displays. To change the contact information, tap **Edit**.

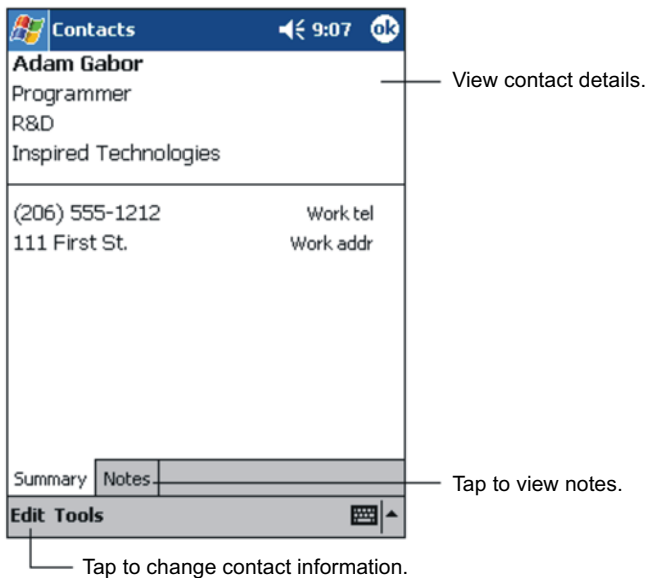

Tasks: Keeping a To Do List

Use Tasks to keep track of what you have to do.

Select the category of tasks you want to display in the list.

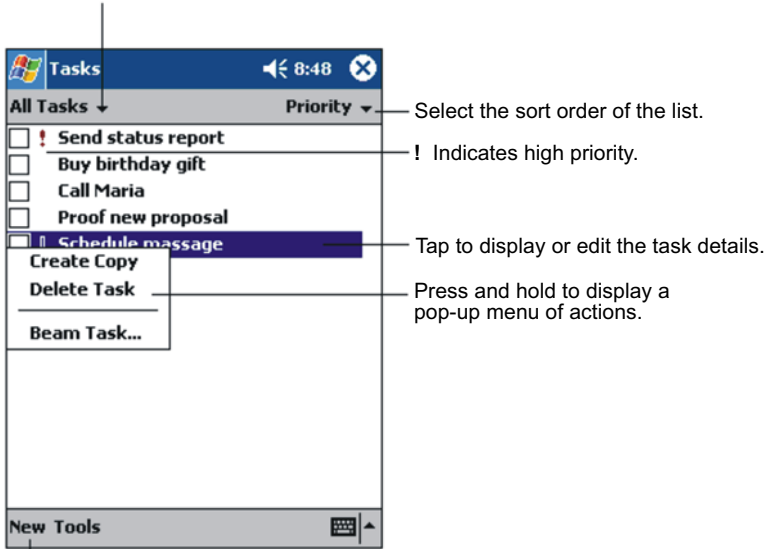

Select the sort order of the list.

! Indicates high priority.

Tap to display or edit the task details.

Press and hold to display a pop-up menu of actions.

Tap to create a new task.

Creating a Task

1 Tap **New**.

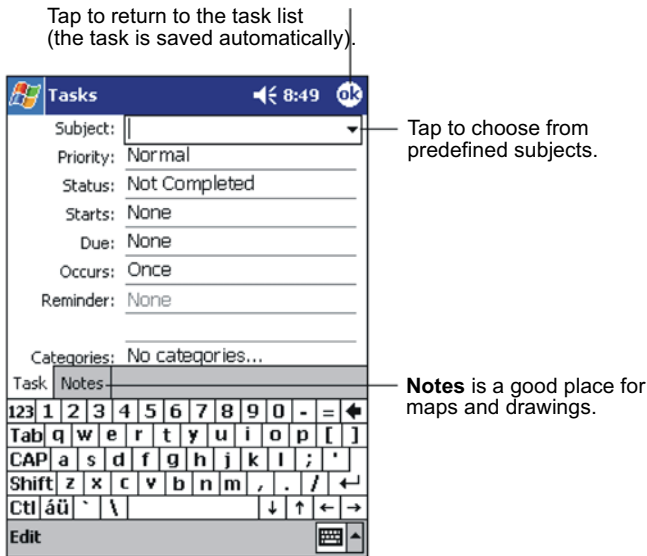

2 Using the Input panel, enter a description.

3 You can enter a start date and due date, or enter other information by first tapping the field. If the Input panel is open, you will need to hide it to see all available fields.

4 To assign the task to a category, tap **Categories** then select a category from the list. In the task list, you can display tasks by category.

5 To add notes, tap the **Notes** tab. You can enter text, draw, or create a recording. For more information on creating notes, see "Notes: Capturing Thoughts and Ideas" later in this chapter.

6 Tap **OK** to return to the task list.

Using the Summary Screen

When you tap a task in the task list, a summary screen displays. To change the task, tap **Edit**.

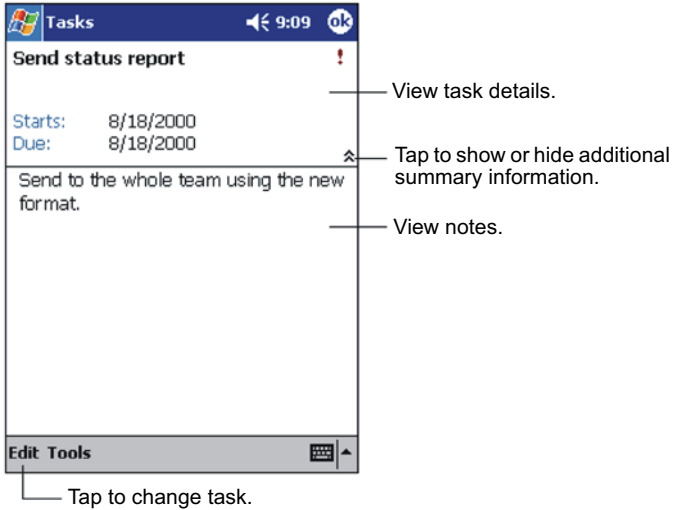

Notes: Capturing Thoughts and Ideas

Quickly capture thoughts, reminders, ideas, drawings, and phone numbers with Notes. You can create a written note or a recording. You can also include a recording in a note. If a note is already open when you create the recording, it will be included in the note as an icon. If the note list is displayed, the recording will be created as a stand-alone recording.

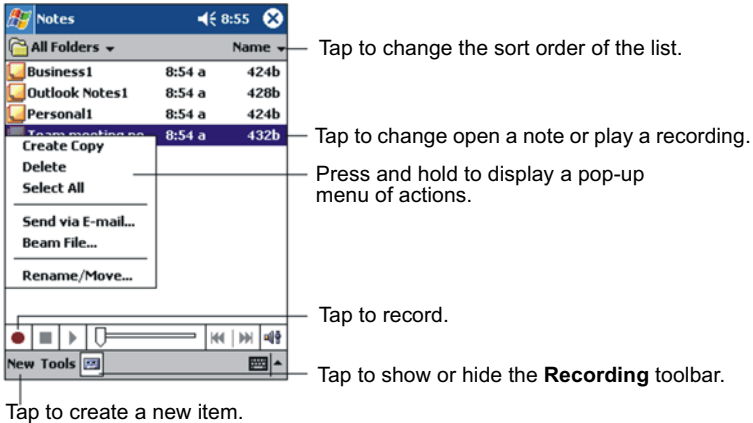

Creating a Note

- 1 Tap **New**.
- 2 Create your note by writing, drawing, typing, or recording. For more information about using the Input panel, writing and drawing on the screen, and creating recordings, see "Entering Information" in Chapter 2.

Inbox: Sending and Receiving Email

Use the Inbox to send and receive e-mail messages with Microsoft Outlook on your PC.

Synchronizing Email Messages

Email messages can be synchronized as part of the general synchronization process. To do this, you need to enable Inbox synchronization in ActiveSync. For information on enabling Inbox synchronization, see ActiveSync Help on the PC.

During synchronization:

- Messages are copied from the mail folders of Exchange or Outlook on your PC to the ActiveSync folder in Inbox on your V37.
- Email messages in the Outbox folder on your V37 are transferred to Exchange or Outlook, and then sent from those programs.
- Email messages in subfolders must be selected in ActiveSync on your PC in order to be transferred.

Using the Message List

Messages you receive are displayed in the message list. By default, the most recently received messages are displayed first in the list.

Select the Internet Service Provider and the folder you want to display.

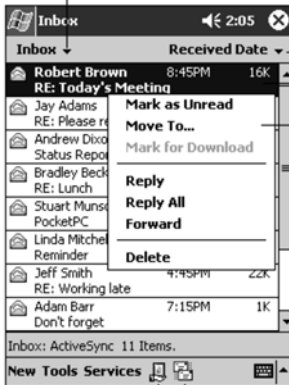

Select the sort order for messages.

Tap to open a message.

Press and hold to display a pop-up menu of actions.

Tap to connect, and to send and receive e-mail.

Tap to connect to the selected Internet Service Provider.

When you receive a message, tap it to open it. Unread messages are displayed in bold.

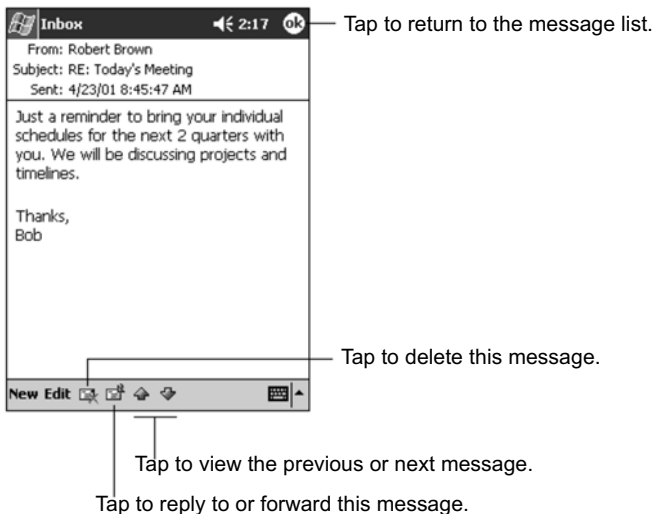

IMPORTANT: When you synchronize with your PC, by default, you will receive messages from the last three days only, the first 100 lines of each new message, and file attachments of less than 100 KB in size. The original messages remain on your PC.

To compose a message, do the following:

- 1 Tap **New**.
- 2 In the **To** field, enter an email of one or more recipients, separating them with a semicolon, or select a name from the contact list by tapping the **Address Book** button. All email addresses entered in the email fields in Contacts appear in the Address Book.

Tap to send the message.



Tap to show or hide the complete header.

Tap to show or hide the recording toolbar.

Tap to display the Address Book.

Tap to insert common (frequently used) messages.

- 3 Compose your message. To enter preset or frequently used messages, tap **My Text** and select a message.
- 4 Tap **Send** when you have finished the message. If you are working offline, the message is moved to the Outbox folder and is sent the next time you connect. The message is placed in the Outbox folder on your device.

Managing Email Messages and Folders

By default, messages are displayed in one of five folders for each service you have created: Inbox, Deleted Items, Drafts, Outbox, and Sent Items. The Deleted Items folder contains messages that were deleted from the V37.

The behavior of the Deleted and Sent Items folders depends on the options you have chosen. In the message list, tap **Tools** then tap **Options**. On the **Message** tab, select your options.

If you want to organize messages into additional sub-folders, tap **Tools**, then tap **Manage Folders** to create new folders. To move a message to another folder, in the message list, press and hold the message then tap **Move** on the pop-up menu.

6 Companion Programs

This chapter tells you about Microsoft Pocket Word and Microsoft Pocket Excel.

Pocket Word

Microsoft Pocket Word works with Microsoft Word on your PC to give you easy access to copies of your documents. You can create new documents on your V37 or you can copy documents from your PC.

IMPORTANT: Synchronize documents between your PC and your V37 regularly so that you have the most up-to-date content in both locations.

Using Pocket Word

- 1 On the **Start**, tap **Programs** and then tap the **Pocket Word** icon.
- 2 Type the name of a document in the file list or tap **New** to open a blank document.

NOTE: To open a template rather than a blank document, select a template for new documents. Tap on the **Tools** menu, tap **Options**, then browse to select the default template. When you tap **New**, the template appears with appropriate text and formatting already provided.

You can open only one document at a time; when you open a second document, you will be asked to save the first. You can save a document you create or edit in a variety of formats, including Pocket Word (.psw), Rich Text Format (.rtf), and Plain Text (.txt).

You can enter information in Pocket Word in four modes: writing, drawing, typing, and recording. Use the **View** menu to switch between modes. Each mode has its own toolbar which you can show or hide by tapping the **Show/Hide Toolbar** button on the Command bar.

- **Typing Mode.** Use the Input panel to enter typed text into the document with the soft keyboard. For more information on entering typed text, see "Entering Information" in Chapter 2.
- **Writing Mode.** In writing mode, use your stylus to write directly on the screen. Ruled lines are displayed as a guide, and the zoom magnification is greater than in typing mode to allow you to write more easily. For more

information on writing and selecting writing, see “Entering Information” in Chapter 2.

NOTE: Written words are converted to graphics (metafiles) when a Pocket Word document is converted to a Word document on your PC.

- **Drawing mode.** In drawing mode, use your stylus to draw on the screen. Gridlines appear as a guide. When you lift your stylus off the screen after the first stroke, you will see a drawing box indicating the boundaries of the drawing. Every subsequent stroke within or touching the drawing box becomes part of the drawing. For more information on drawing and selecting drawings, see “Entering Information” in Chapter 2.
- **Recording mode.** Use recording mode to embed a recording into your document. Recordings are saved as WAV files. For more information on recording, see “Entering Information” in Chapter 2.

Tips for Working in Pocket Word

- You can change the zoom magnification by tapping **View** and then tapping **Zoom**. Then select the percentage you want. Select a higher percentage to enter text and a lower one to see more of your document.
- If you are opening a Word document created on a PC, select **Wrap to Window** on the **View** menu so that you can see the entire document.

Pocket Excel

Microsoft Pocket Excel works with Microsoft Excel on your PC to give you easy access to copies of your workbooks. You can create new workbooks in your V37, or you can copy workbooks from your PC to your V37. Synchronize workbooks between your PC and your V37 so that you have the most up-to-date content in both locations. Pocket Excel provides fundamental spreadsheet tools, such as formulas, functions, sorting, and filtering, which enable you to create simple workbooks, such as expense reports and mileage logs.

- 1 On the **Start** menu, tap **Programs** and then tap the **Pocket Excel** icon.
- 2 Tap the name of a workbook in the file list or tap **New** to open a blank workbook.

You can open only one workbook at a time; when you open a second workbook, you will be asked to save the first. You can save a workbook you have created or edit in a variety of formats, including Pocket Excel (.pxl) and Excel (.xls).

Tips for Working in Pocket Excel

- View in full-screen mode to see as much of your worksheet as possible. Tap **View** and then tap **Full Screen**. To exit full-screen mode, tap **Restore**.
- If your workbook contains sensitive information, you can protect it with a password. To do so, open the workbook, tap **Edit**, and then tap **Password**.
- Show or hide window elements. Tap **View** then tap the elements you want to show or hide.

- Freeze panes on a worksheet. First, select the cell where you want to freeze panes. Tap **View** and then tap **Freeze Panes**. You might want to freeze the top and furthest left panes in a worksheet to keep row and column labels visible as you scroll through a sheet.
- Split panes to view different areas of a large worksheet. Tap **View** and then tap **Split**. Then drag the split bar to where you want it. To remove the split, tap **View** and then tap **Remove Split**.
- Show and hide rows and columns. To hide a row or column, select a cell in the row or column you want to hide, tap **Format**, tap **Column**, then tap **Hide**. To show a hidden row or column, tap **Tools**, tap **Go To** then type a reference that is in the hidden row or column. Tap **Format**, then tap **Row** or **Column**, then tap **Unhide**.

Windows Media Player for Pocket PC

Use Microsoft Windows Media Player for V37 to play digital audio and video files that are stored on your V37 or on a network. To switch to Windows Media Player for V37, tap  and tap **Windows Media**.

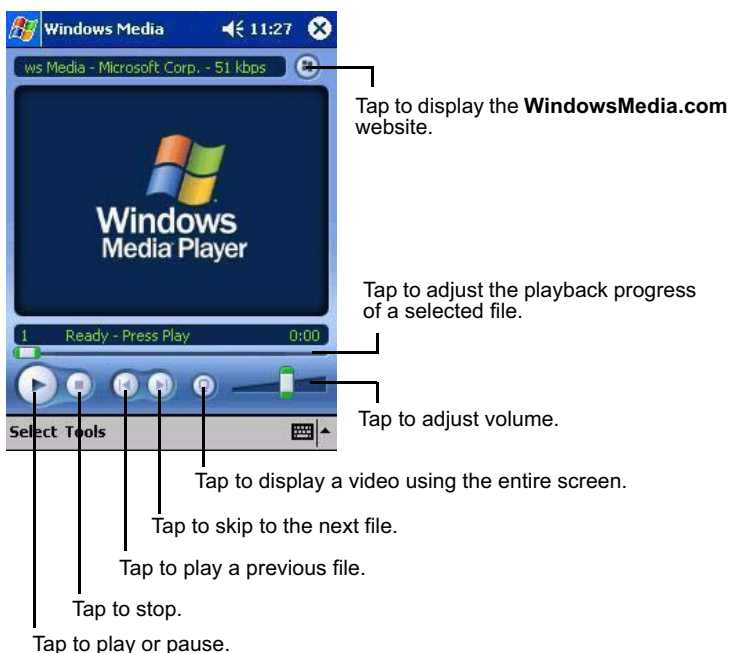

Use Microsoft Windows Media Player on your PC to copy digital audio and video files to your V37. You can play Windows Media and MP3 files on your V37.

For more information about using Windows Media Player, tap  then tap **Help**.

Microsoft Reader

Use Microsoft Reader to read eBooks on your V37. Download books to your PC from your favorite eBook Web site. Use ActiveSync to copy the book files to your activated V37. The books appear in the Reader Library, where you can tap them in the list to open them.

NOTE: Before you can use Microsoft Reader, you must activate it from the Microsoft activation site (<http://das.microsoft.com/activate>). Follow the directions given at the Microsoft site.

Each book consists of a cover page, an optional table of contents, and the pages of the book. You can:

- Page through the book by using the scroll dial on your V37 or by tapping the page number on each page.
- Annotate the book with highlighting, bookmarks, notes, and drawings.
- Search for text or look up definitions for words.

The Guidebook contains all the information you need to use the software. To open the Guidebook, tap **Help** on the Reader command bar. Or, on a book page, press and hold on the book title, and then tap **Help** on the pop-up menu.

To switch to Microsoft Reader, tap , tap **Programs** then tap **Microsoft Reader**.

Getting Books onto Your V37

You can download book files from the Web. Just visit your favorite eBook retailer and follow the instructions to download the book files.

Sample books and a dictionary are also included in the MSReader folder on the Companion CD.

Use ActiveSync to download the files from your PC to your activated V37 as described in the Read Me file in the MSReader folder.

Using the Library

The Library is your Reader home page. The home page displays a list of all books stored on your V37 or storage card.

To open the Library:

- On the Reader command bar, tap **Library**.
- On a book page, tap the book title, and tap **Library**, on the pop-up menu.

To open a book, tap its title in the Library list.

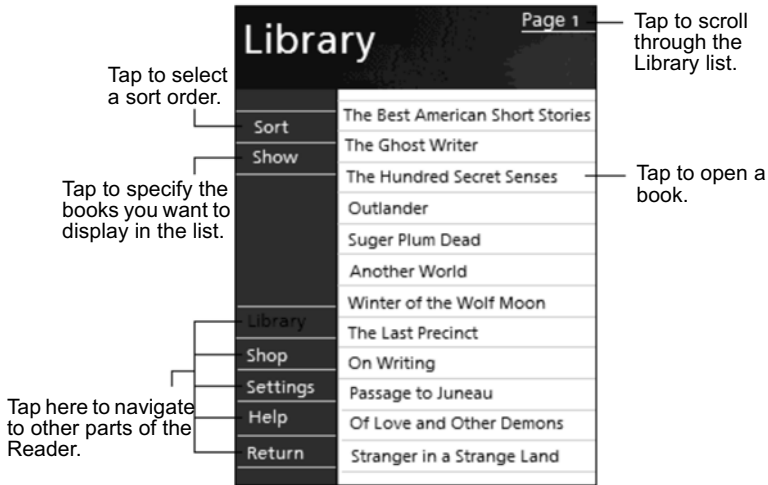

Reading a Book

Each book consists of a cover page, an optional table of contents, and the pages of the book. Navigation options are listed in the bottom portion of the cover page.

The first time you open a book, you will probably want to go to the first page or to the table of contents, if there is one. Subsequently, whenever you open the book, you automatically go to the last page read.

In addition to the text, each book page includes a page number and book title.

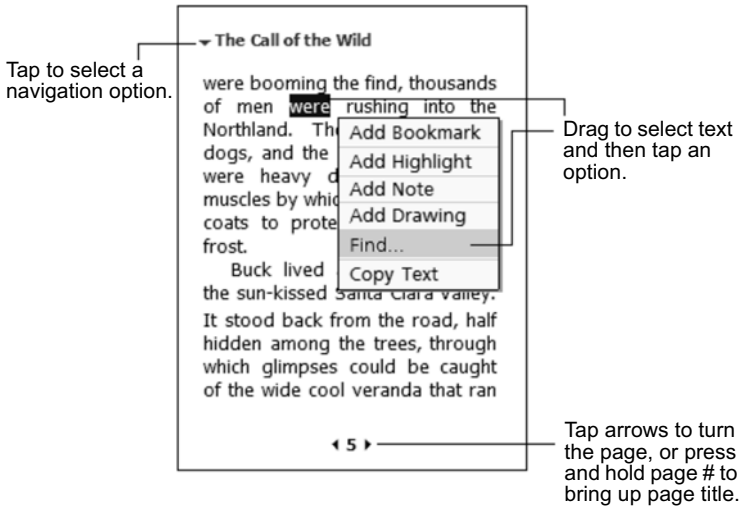

You can also page through a book by using the scroll dial on your V37.

Using Reader Features

Reading a book electronically gives you several options not available with paper books. These options are available from any book page.

Select text by dragging across the text on the page. Then, tap an option on the pop-up menu, as described here.

- **Search for Text.** Find text in a book by tapping **Find** on the pop-up menu. Enter the word you want to search for, and tap the desired Find option. Reader highlights found text on the page. To close Find, tap outside the box. To return to your original page, tap the title and then tap **Return** on the popup menu.
- **Copy Text.** You can copy text from books that support this feature into any program that accepts text. On a book page, select the text you want to copy. Then, tap **Copy Text** on the pop-up menu. The text can be pasted into the program of your choice.

- **Bookmarks.** When you add a bookmark to a book, a color-coded bookmark icon appears in the right margin. You can add multiple bookmarks to a book. Then, from anywhere in the book, tap the bookmark icon to go to the bookmarked page.
- **Highlights.** When you highlight text, it appears with a colored background.
- **Notes.** When you attach a note to text, you enter the text in a note pad that appears on top of the book page. A Note icon displays in the left margin. To show or hide the note, tap the icon.
- **Drawings.** When you add a drawing, a Drawing icon appears in the bottom-left corner of the page and drawing tools appear across the bottom of the page. Draw by dragging your stylus.

NOTE: To see a list of a book's annotations, including bookmarks, highlights, text notes, and drawings, tap **Annotations Index** on the book's cover page. You can tap an entry in the list to go to the annotated page.

Removing a Book

When you finish reading a book, you can delete it to conserve space on your V37. If a copy of the book is stored on your PC, you can download it again at any time.

To remove a book from your V37, press and hold the title in the Library list, and then tap **Delete** on the pop-up menu.

Other Programs

The following programs are permanently installed in your V37:

Program	How to Access the Program
Infrared Receiver	On the Start menu, tap Programs and then tap the Infrared Receive icon. Infrared Receive establishes the connection between your V37 and the IR device.
Terminal Services	On the Start menu, tap Programs and then tap the Terminal Services icon. Terminal Services allows you to access the programs and documents in a Windows NT server type PC that is running Terminal Services.
Backup	On the Start menu, tap Programs and then tap the Backup icon. Backup enables you to back up all data stored in the internal (RAM) memory on your V37. For more information, see section "Backing up Data" in Chapter 3.
.NET Compact Framework	.NET Compact Framework is built into the V37's Flash ROM image. Microsoft's Compact Framework provides developers an easy to use tool to develop managed code and XML web service clients for Pocket PCs and other smart devices. Because Compact Framework is a subset of Framework, developers can reuse existing Visual Studio .NET code and skills in smart device, desktop, and server environments.

You can also install the following programs from the V37 Companion CD:

	Program	Description
	ClearVue™ Image Viewer	Allows you to view BMP, JPG, and PNG images.
	ClearVue™ Presentation Viewer	Allows you to view presentations created with Microsoft PowerPoint 97, PowerPoint 2000, and PowerPoint 2002 (XP).

7 Pocket Internet Explorer

This chapter tells you about Microsoft Pocket Internet Explorer, Mobile Favorites Folder and AvantGo Channels.

Using Pocket Internet Explorer

Use Microsoft Pocket Internet Explorer to view Web pages by doing the following:

- During synchronization with your PC, download your favorite links and mobile favorites that are stored in the Mobile Favorites subfolder in Internet Explorer on the PC.

To start Pocket Internet Explorer:

- On the **Start** menu, tap **Internet Explorer**. The Pocket Internet Explorer home page:

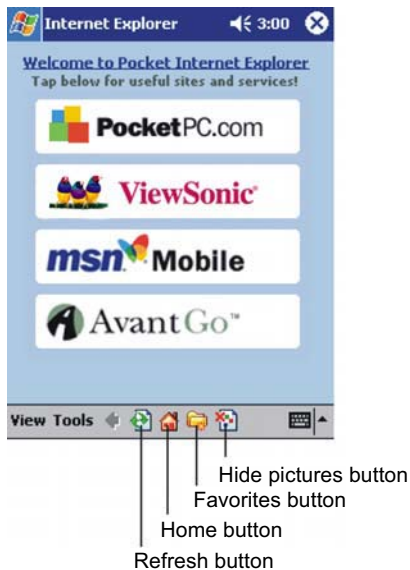

Viewing Mobile Favorites and Channels

- 1 Tap the **Favorites** button to display your list of favorites.
- 2 In the list, tap the page you want to view.

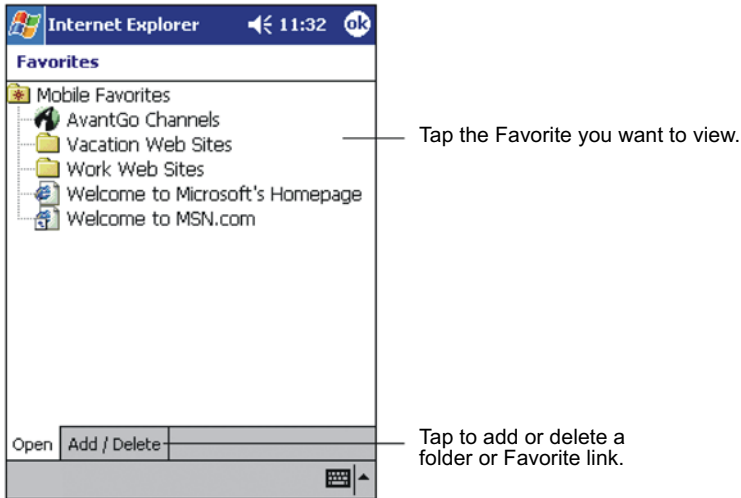

You will see the page that was downloaded the last time you synchronized with your PC. If the page is not on your V37, it will be dimmed in the Favorites list. You will need to synchronize with your PC again to download the page to your V37, or connect to the Internet to view the page.

Browsing the Internet

To connect and start browsing, do one of the following:

- Tap the **Favorites** button, and then tap the favorite you want to view.
- Tap **View**, and then tap **Address Bar**. In the address bar that appears at the top of the screen, enter the Web address you want to visit and then tap **Go**. Tap the arrow to choose from previously entered addresses.

The Mobile Favorites Folder

Only items stored in the Mobile Favorites subfolder in the Favorites folder in Internet Explorer on your PC will be synchronized with your Pocket PC. This folder is created automatically when you install ActiveSync.

Favorite Links

During synchronization, the list of favorite links in the Mobile Favorites folder on your PC is synchronized with Pocket Internet Explorer on your V37. Both computers are updated with changes made to either list each time you synchronize. Unless you mark the favorite link as a mobile favorite, only the link (and not the page) will be downloaded to your V37, and you must connect to your ISP or network to view the content. For more information on synchronization, see ActiveSync Help on your PC.

Mobile Favorites

If you are using Microsoft Internet Explorer 5 or later on your PC, you can download mobile favorites to your V37. When you synchronize your PC and V37, the content of your mobile favorites is downloaded to your V37 so that you can view pages while you are not connected to your ISP or your network.

Use the Internet Explorer plug-in installed with ActiveSync to create mobile favorites quickly.

To create a mobile favorite:

- 1 In Internet Explorer on your PC, click **Tools**, and then click **Create**.
 - To change the link name, enter a new name in the Name box.
 - To change how often the mobile favorite is updated, select a desired update schedule under **Update**.
- 2 Click **OK**. Internet Explorer downloads the latest version of the page to your PC.
- 3 If you want to download the pages that are linked to the mobile favorite you just created, right-click the mobile favorite and then click **Properties**. On the **Download** tab, specify the number of links deep you want to download. To conserve memory on your V37, download only one level of links.
- 4 Synchronize your V37 and PC. Mobile favorites that are stored in the Mobile Favorites folder in Internet Explorer are downloaded to your V37.

NOTE: If you do not specify an updated schedule, you must manually download content to keep the information updated on your PC and V37. Before synchronizing in Internet Explorer or your PC, click **Synchronize** on the **Tools** menu. You will see the last time content was downloaded to your PC, and you can manually download if needed.

NOTE: You can add a button to the Internet Explorer toolbar for creating mobile favorites. In Internet Explorer on your PC, on the **View** menu, click **Toolbars**, and then click **Customize**.

Conserving Memory

Mobile favorites take up storage memory on your V37. Follow these tips to minimize the amount of memory used:

- Use ActiveSync settings to turn off pictures and sounds for the Mobile Favorites information type or to stop some mobile favorites from being downloaded to your V37. For more information, see ActiveSync Help.
- Limit the number of downloaded linked pages. In Internet Explorer on the PC, right-click the mobile favorite you want to change, and then click **Properties**. On the **Download** tab, specify 0 or 1 for the number of linked pages you want to download.

Using AvantGo Channels

AvantGo is a free interactive service that gives you access to personalized content and thousands of popular Web sites. You subscribe to AvantGo channels directly from your V37. Then you synchronize your V37 with your PC or connect to the Internet to download the content. For more information, visit the AvantGo Web site.

To sign up for AvantGo:

- 1 In ActiveSync options on the PC, turn on synchronization for the AvantGo information type.
- 2 In Pocket Internet Explorer on your V37, tap the **Favorites** button to display your list of favorites.
- 3 Tap the **AvantGo Channels** link.
- 4 Tap the **Activate** button.
- 5 Follow the directions on the screen. You will need to synchronize your V37 with your PC, and then tap the **My Channels** button to complete the AvantGo setup.

When synchronization is complete, tap the **AvantGo Channels** link in your list of favorites to see a few of the most popular channels. To add or remove channels, tap the **Add** or **Remove** link.

8 Getting Connected

This chapter explains how to connect your V37 to the Internet or to a network using a wireless connection. In addition, the chapter explains how to connect to other mobile devices or your PC using an infrared (IR) connection.



Connecting to a Network or the Internet

You can connect to a wireless network at work or at home by installing an SDIO 802.11B (WiFi) network card (purchased separately) into the V37's SDIO slot. Once connected to a network, you can send and receive email messages using Inbox and/or access web pages on the Internet using Pocket Internet Explorer. See *Creating a Wireless Connection to a Network* below for information about using a wireless connection.

Creating a Wireless Connection to a Network

You first need to install an 802.11B (WiFi) SDIO network card (purchased separately). For instructions on inserting and using the SDIO WiFi or network card, see the owner's manual for the card.



NOTE: Make sure your SDIO card is compatible with **SDIO Now!** technology, developed by bSquare Inc.

- 1 If applicable, obtain the following information from your network administrator: *user name*, *password*, and *domain name*.
- 2 You do not need to create a new connection on your V37. The first time you install the SDIO network card, Network Settings appears automatically so you can configure the network card. Most networks use DHCP, so you should not have to change settings unless your network administrator instructs you to do so. If you need to change settings, do the following: Tap **OK**. If it does not appear to change settings later, tap  and tap **Settings**. On the **Connections** tab, tap **Network Adapters**, tap the adapter you want to change, and tap **Properties**.
- 3 Tap , tap **Settings**, and tap the **Connections** tab. From **My network card connects to** list, tap **Work**, and tap **OK**.

Creating a Wireless Connection to the Internet

You first need to install an 802.11B (WiFi) SDIO network card (purchased separately). For instructions on inserting and using the SDIO WiFi or network card, see the owner's manual for the card.

NOTE: Make sure your SDIO card is compatible with **SDIO Now!** technology, developed by bSquare Inc.

- 1 If applicable, obtain the following information from your ISP (Internet Service Provider): *user name*, *password*, and *domain name*.
- 2 You do not need to create a new connection on your V37. The first time you install the SDIO network card, Network Settings appears automatically so you can configure the network card. Most networks use DHCP, so you should not have to change settings unless your network administrator instructs you to do so. If you need to change settings, do the following: Tap **OK**. If it does not appear to change settings later, tap  and tap **Settings**. On the **Connections** tab, tap **Network Adapters**, tap the adapter you want to change, and tap **Properties**.
- 3 Tap , tap **Settings**, and tap the **Connections** tab. From the **My network card connects to** list, tap **The Internet**, and tap **OK**.

Using an Infrared Connection

An infrared (IR) connection will allow you use your V37 to exchange information (such as contacts and appointments) with other mobile devices as well as your PC. (For more information, see "Using Microsoft ActiveSync" in Chapter 4.)

Use the infrared (IR) port on the V37 to exchange (send/receive) files with another mobile device.

Sending Information

- 1 Switch to the program in which you created the item you want to send then locate the item in the list.
- 2 Align the IR ports so that they are unobstructed and within a close range.

CAUTION: If the devices are too far apart or if something blocks the path between the two ports, data might not be sent or received correctly.

- 3 Press and hold the item, then tap **Beam Item** on the pop-up menu.

NOTE: You can also send items, but not folders, from File Explorer. Press and hold the item you want to send, then tap **Beam File** on the pop-up menu.

Receiving Information

- 1 Align the IR ports so that they are unobstructed and within a close range.
- 2 Tap , tap **Programs**, then tap **Infrared Receive**.
- 3 Have the owner of the other device send the information to you. Your V37 will automatically receive it.

9 Troubleshooting and Maintenance

This chapter gives solutions to common V37 problems you may encounter when using the device. It also provides guidelines on taking care of your V37.

NOTE: If you encounter a problem you cannot solve, contact your reseller or ViewSonic Customer Support. See the “Customer Support” section at the end of this chapter.

Resetting your V37

CAUTION: Resetting will cause unsaved data to be lost.

Resetting your V37 is similar to restarting your PC. It restarts the operating system, but you will lose any unsaved data. Occasionally, you may need to reset your V37. For example, you should reset your V37:

- After you restore data from your PC.
- When your V37 stops responding. (In other words, it appears to be “frozen” or “locked up.”)

Follow this procedure to reset your V37:

- 1 Remove the memory card (if installed).

- 2 Unscrew the cap at the top of the stylus. Use the pointed tip of the cap to press the reset button on the side of your V37.



Restoring Factory Defaults

In some cases, you may need to restore your V37 to the factory default settings by clearing the memory (RAM) from your V37. For example, you should clear the memory:

- When your V37 does not respond after being reset.
- When you forget your password.

Clearing the memory means all data you have entered in RAM, including all files, system settings, and additional programs you have installed, will be erased. (Programs installed to ROM at the factory are not affected.)

CAUTION:

- **To ensure the integrity of your data should it be necessary to clear the memory, you are advised to regularly back up to your PC (using ActiveSync), or to an optional SD card (using the backup application). For more information on backing up data, see “Backing Up Data” in Chapter 3.**
- **Do not push the battery switch unless it is necessary.**

Follow this procedure to clear the memory from your V37:

- 1 Disconnect all cables, including the AC adapter, from your V37.
- 2 Unscrew the cap at the top of the stylus. Use the pointed tip of the cap to push the battery switch to the OFF (up) position.



- 3 Wait for three (3) minutes then push the battery switch to the ON (down) position.
- 4 The Notification indicator will flash red for approximately 30 seconds, and then your V37 will automatically turn on and display the Welcome Wizard screen.

NOTE: If the battery runs completely out of power and is not re-charged in time, the memory of your V37 will be cleared.

Power Problems

Power does not turn on when using battery power

- The remaining battery power may be too low to run your V37. Connect the AC adapter to your V37 and to external AC power. Then, turn on your V37. (Charge the battery whenever possible to avoid running out of battery power.)





Battery runs out of power quickly

- You might be using your V37 in ways that drain power quickly. (See "Managing Power" in Chapter 3 for tips on saving power.)

Memory Problems

If a warning message of not enough memory appears due to the memory allocation problem, try the following to free memory on your V37.

CAUTION: Be discreet when you delete files. Deleting files of which the function is unknown can cause programs or features to malfunction. It is recommended that you to create a backup before deleting files.

- Delete files you no longer need. Tap , **Programs**, and then **File Explorer**. Press and hold the file you wish to delete, then tap **Delete** on the pop-up menu. To find your largest files, tap  then **Find**. In the **Type** list, tap **Larger than 64KB**, then tap **Go**.
- Remove programs you no longer need. Tap  and then **Settings**. Tap **System** tab, then tap **Remove Programs**. Tap the program you want to remove then tap **Remove**.
- In Internet Explorer options, delete all files then clear history. In Internet Explorer, tap **Tools** then **Options**. Tap **Delete Files** then **Clear History**.
- If you are copying files from a computer or other device to your V37, try adjusting the slider in the Memory setting. Tap  then **Settings**. Tap **System** tab, then tap **Memory**. Check to see if you can manually move the slider before copying files.

Stop programs you are not currently using. In most cases, programs automatically stop to free needed memory. However, in some situations, such as when confirmation dialog boxes are waiting for a user response, the program may not be able to automatically stop. To check the state of your active programs, tap  then **Settings**. Tap **System** tab, tap **Memory**, then **Running Programs**. Tap the program you want to view then tap **Activate**. Close any open windows or messages and return the program to list view. If this does not work, you can stop the program manually. First, make sure that your work is saved by closing open items and return the program to list view. Then, stop the program by tapping **Stop** or **Stop All** on the **Running Programs** tab.

Reset your V37 as described earlier in this chapter.

If you have an SD card, move data to the SD card as follows:

- Tap , **Programs**, then **File Explorer**. Press and hold the file you want to move, then tap **Cut**. Browse to My Documents folder in the SD card folder, tap **Edit**, then **Paste**. Files stored in folders other than My Documents or stored in subfolders within subfolders in My Documents may not show up in the list view of some programs. When using Notes, Pocket Word, or Pocket Excel, you can also move files by opening the item then tapping **Tools** or **Edit** then **Rename/Move**.

Files stored in folders other than My Documents or stored in subfolders within subfolders in My Documents may not show up in the list view of some programs. When using Notes, Pocket Word, or Pocket Excel, you can also move files by opening the item then tapping **Tools** or **Edit** then **Rename/Move**.

Screen Problems

Screen is off

If the screen does not respond, even after you press the power button, try the following until the problem is solved:

- Connect the AC adapter to your V37 and to external AC power, then
- Reset your V37 as described in "Resetting Your V37" earlier in this chapter.

Screen responds slowly

- Make sure that your V37 is not running out of battery power or running many active programs. If the problem still exists, reset your V37 as described in "Resetting Your V37" earlier in this chapter.

Screen freezes

- Reset your V37 as described in "Resetting Your V37" earlier in this chapter.

Screen is hard to read

- Make sure that the backlight of the display is on.
- Move to a location with enough light.
- If you are having a hard time reading a document on the screen, try adjusting the zoom percentage or text size.
 - In Notes, tap **Tools** and select a zoom percentage.
 - In Pocket Word and Pocket Excel, tap **View**, tap **Zoom** then select a zoom Percentage.
 - In Pocket Internet Explorer, tap **View**, tap **Text Size** then select a size.
 - In Calendar, Contacts, and Tasks, tap **Tools**, tap **Options** then select User large font.

Inaccurate response to stylus taps

Realign the touch screen. Tap  and tap **Settings**. Tap **System** tab then tap **Align Screen**. If you cannot realign the touch screen, turn off the V37. Press and hold the scroll dial, then press the power button to turn on the V37. You should now be able to start the touch screen alignment process.



V37Connection Problems

USB Cradle Connection Problems

- Make sure that you have installed the correct version of ActiveSync on your desktop PC. Install the version ActiveSync included with your V37.
- Make sure that your V37 and your desktop PC are turned on.
- Make sure that you do not have any other active connections.
- When using the USB cradle, make sure that your V37 is properly seated.

- Make sure that the cable is securely plugged into the USB port on your desktop PC. Connect the USB cable directly to your desktop PC — do not run the cable through a USB hub.
- Make sure that the USB connection is enabled in ActiveSync on your desktop PC. If the USB connection is already enabled, disable the USB connection, close the Connection Settings window, and then reopen and re-enable the USB connection.
- Reset your V37 before connecting the USB cable. (See “Resetting Your V37” earlier in this chapter.) Always disconnect your V37 before you restart your desktop PC.
- Connect only one V37 or personal digital assistant to your desktop PC at a time.

Network Connection Problems

- Make sure that the SDIO network card is compatible with your Pocket PC V37 (compatible with **SDIO Now!** technology, developed by bSquare Inc.)
- Make sure that you have installed the proper drivers for your V37.
- In the Properties for your network card, make sure that you have correctly configured the IP settings, and the addresses of your DNS servers and/or WINS servers. Your network administrator can verify this.
- Make sure that you have added necessary server information. Tap  and then **Settings**. Tap the **Connections** tab, and then tap **Network Adapters**. Select the installed network card (usually the card’s name) and enter any necessary information. Most networks use DHCP to assign IP addresses dynamically; you should not have to change or enter any IP address unless your network administrator instructs you to do so.
- Verify with your network administrator that your user name and password are correct.
- Verify with your network administrator that the network you are trying to connect to is available, or try to connect to it from another computer.
- You may need to change the device name if you are trying to connect to a network and cannot because another device with the same name is already connected. To change the device name, tap  and then **Settings**. Tap the **System** tab, tap **About**, and then tap the **Device ID** tab.

Infrared Connection Problems

- Transfer only one file, or no more than 25 contact cards, at a time.
- Position the IR ports so that they line up at a distance less than 20 cm (8 inches) but more than 5 cm (2 inches) apart.
- Make sure that there are no obstacles between the two IR ports.
- Adjust the room lighting. Some types of light interfere with IR communications. Try moving to a different location or turning off some lights.

Care and Maintenance

Taking good care of your V37 will ensure trouble-free operation and reduce the risk of damage to your V37.

General Guidelines

- Keep your V37 away from excessive moisture and extreme temperatures.
- Avoid exposing your V37 to direct sunlight or strong ultraviolet light for extended periods of time.
- Do not place anything on top of your V37 as this may damage the display.
- Do not drop your V37.
- Store your V37 in a protective case when not in use.
- The screen surface is easily scratched. Use only the stylus to tap on the screen. Avoid touching it with your fingers, pens, or pencils.
- Never clean your V37 with the power on. Use a soft, lint-free cloth moistened with water to wipe the screen and the exterior of your V37.
- Never use paper towels to clean the screen.

Travel Guidelines

- Before traveling with your V37, back up your data. As an added precaution, bring along a backup copy.
- Turn off your V37 and disconnect all external devices.
- Make sure that the battery is fully charged.
- Take the AC adapter with you. Use the AC adapter as the power source and as a battery-recharger.
- Hand-carry your V37 in a protective case.
- Consult the airlines first before using your V37 on the plane. You need to be very careful when using electronic devices during the flight.
- If you plan to travel abroad with your V37, consult your dealer for the appropriate AC adapter for use in your country of destination.

Customer Support

For technical support or product service, see the table below or contact your reseller.

IMPORTANT:

- **You will need to provide the product serial number (on the back of the V37).**
- **Before sending the V37 out for service, be sure to backup all data and remove all third party software. See the Data Loss Disclaimer in the Appendix**

Country/ Region	Website / Email	T = Telephone F = FAX
United States	www.viewsonic.com/support vstech@viewsonic.com	T: (800) 688-6688 F: (909) 468-1202
Canada	www.viewsonic.com/support vstech@viewsonic.com	T: (800) 688-6688 F: (909) 468-1202
United Kingdom	www.viewsoniceurope.com service.eu@viewsoniceurope.com	T: 0800 833 648 F: 01794 500801
Europe, Middle East, Baltic countries, and North Africa	www.viewsoniceurope.com service.eu@viewsoniceurope.com	Contact your reseller
Australia and New Zealand	www.viewsonic.com.au service.au@viewsonic.com	T: +61 2 9929 3955 F: +61 2 9929 8393
Singapore/India and Southeast Asia	www.viewsonic.com.sg service.sg@viewsonic.com	T: 65 273 4018 F: 65 273 1566
Other Asia/Pacific countries	www.viewsonic.com.tw service.ap@viewsonic.com.tw	T: 886 2 2246 3456 F: 886 2 8242 3668
South Africa	www.viewsonic.com/asia service.ap@viewsonic.com	T: 886 2 2246 3456 F: 886 2 8242 3668

10 Appendix

Regulatory and Safety Information

Class B Regulations



USA

This equipment complies with the limits for a class B digital device as specified in Part 15 of FCC Rules which provide reasonable protection against harmful interference in a residential area. This equipment generates and uses radio frequency energy, and if not installed and used in accordance with the instructions, may cause harmful interference to radio communications. However, there is no guarantee that interference will not occur in a particular installation. In the unlikely event that there is interference to radio or television reception (which can be determined by turning the equipment off and on), the user is encouraged to try to correct the interference by one or more of the following measures:

- Reorienting or relocating the receiving antenna (radio or television).
- Relocating the equipment with respect to the receiver.
- Consult your dealer or an experienced radio/television technician.
- Any changes or modifications to the equipment not expressly approved by the manufacturer could void the user's authority to operate this equipment.
- Use of a shielded interface cable is required to comply with the Class B limits of Part 15 of FCC rules.

Canada

This Class B digital apparatus meets all requirements of the Canada Interference-Causing equipment regulations.

Cet appareil numérique de Classe B respecte toutes les exigences du Règlement Canadien sur le matériel brouilleur.

European Regulatory Notice

Products with the **CE** mark comply with both the Electromagnetic Compatibility Directive (89/336/EEC) and the Low Voltage Directive (73/23/EEC) - as mandated by Directive 93/68/ECC - issued by the Commission of the European Community.

Compliance with these directives implies conformity to the following European standards:

EN55022: Radio disturbance characteristics

EN55024: Immunity characteristics

EN6100-3-2: Limits for harmonic current emissions

EN6100-3-3: Limitation of voltage fluctuation and flicker in low-voltage supply system

EN60950: Product Safety

Battery Replacement

A Lithium Ion battery in this Pocket PC maintains system configuration information. In the event that the battery fails to maintain system configuration, we recommend that you call your local dealer.

The battery must be replaced by authorized service personnel. Contact your dealer or ViewSonic for service contact information. **Do not attempt to replace the battery yourself.**

WARNING: This unit contains a Lithium Ion battery that is not user-replaceable. To reduce risk of fire or burns, do not disassemble, crush, puncture, or dispose of the battery in fire or water.

About the AC Adapter

CAUTION: Only use the AC adapter (PHIHONG, PSC0R-050) supplied with your Pocket PC V37. Use of another type of AC adapter will result in malfunction and/or danger.

NOTE: This product is intended to be supplied with a Listed Power Unit marked "LPS" and output rated +5 V DC / 900 mA minimum.

The AC adapter is designed to ensure your personal safety and to be compatible with this equipment. Please follow these guidelines:

- Do not use the adapter in a high moisture environment. Never touch the adapter when your hands or feet are wet.
- Allow adequate ventilation around the adapter. Avoid locations with restricted airflow.
- Connect the adapter to a proper power source. The voltage and grounding requirements are found on the product case and/or packaging.
- Do not use the adapter if the cord becomes damaged.
- Do not attempt to service the unit. There are no serviceable parts inside. Replace the unit if it is damaged or exposed to excess moisture.

About Electrostatic Discharge

Electrostatic Discharge Warning

Electrostatic discharges can interfere with the normal functioning of electronic devices. Your Pocket PC can behave abnormally owing to such an event, resulting in the possible data corruption or loss of unsaved data. To recover from this, reset your Pocket PC as described in this User Guide.

NOTE: To avoid losing data due to electrostatic discharges or other types of events, it is recommended that you regularly save and backup data as described in this User Guide.

Limited Warranty

Pocket PC Products

What the warranty covers:

ViewSonic® warrants its Pocket PC products to be free from defects in material and workmanship during the warranty period. If a Pocket PC product proves to be defective in material or workmanship during the warranty period, ViewSonic will, at its sole option, repair or replace the product with a like product. Replacement product or parts may include remanufactured or refurbished parts or components. ViewSonic provides no warranty for the third party software included with the product. For specific warranty information, please see the EULAs included with the product. ViewSonic does not warrant that software will meet your requirements or that operation of software will be uninterrupted or error free. VIEWSONIC AND ITS SUPPLIERS DISCLAIM ALL WARRANTIES AND CONDITIONS, EITHER EXPRESS OR IMPLIED, INCLUDING, BUT NOT LIMITED TO, IMPLIED WARRANTIES OF MERCHANTABILITY, FITNESS FOR A PARTICULAR PURPOSE, AND NON-INFRINGEMENT.

How long the warranty is effective:*

ViewSonic Pocket PCs are warranted for one (1) year for all parts (except software) and one (1) year for all labor from the date of the first consumer purchase.

Who the warranty protects:

This warranty is valid only for the first consumer purchaser.

What the warranty does not cover:

1. Software
2. Any product on which the serial number has been defaced, modified or removed.
3. Damage, deterioration or malfunction resulting from:
 - a. Accident, misuse, neglect, fire, water, lightning, or other acts of nature, unauthorized product modification, or failure to follow instructions supplied with the product.
 - b. Repair or attempted repair by anyone not authorized by ViewSonic.
 - c. Damage to or loss of any programs, data or removable storage media.
 - d. Software or data loss occurring during repair or replacement.
 - e. Any damage of the product due to shipment.
 - f. Removal or installation of the product.
 - g. Causes external to the product, such as electrical power fluctuations or failure.
 - h. Use of supplies or parts not meeting ViewSonic's specifications.
 - i. Normal wear and tear.
 - j. Any other cause which does not relate to a product defect.
4. Removal, installation, and set-up service charges.

How to get service:

1. For information about receiving service under warranty, contact ViewSonic Customer Support. You will need to provide your product's serial number.
2. To obtain service under warranty, you will be required to provide (a) the original dated sales slip, (b) your name, (c) your address, (d) a description of the problem, and (e) the serial number of the product.
3. Take or ship the product freight prepaid in the original container to an authorized ViewSonic service center or ViewSonic.
4. For additional information or the name of the nearest ViewSonic service center, contact ViewSonic.

Limitation of implied warranties:

THERE ARE NO WARRANTIES, EXPRESS OR IMPLIED, WHICH EXTEND BEYOND THE DESCRIPTION CONTAINED HEREIN INCLUDING THE IMPLIED WARRANTY OF MERCHANTABILITY AND FITNESS FOR A PARTICULAR PURPOSE.

Exclusion of damages:

VIEWSONIC'S LIABILITY IS LIMITED TO THE COST OF REPAIR OR REPLACEMENT OF THE PRODUCT. VIEWSONIC SHALL NOT BE LIABLE FOR:

1. DAMAGE TO OTHER PROPERTY CAUSED BY ANY DEFECTS IN THE PRODUCT, DAMAGES BASED UPON INCONVENIENCE, LOSS OF USE OF THE PRODUCT, LOSS OF DATA, LOSS OF TIME, LOSS OF PROFITS, LOSS OF BUSINESS OPPORTUNITY, LOSS OF GOODWILL, INTERFERENCE WITH BUSINESS RELATIONSHIPS, OR OTHER COMMERCIAL LOSS, EVEN IF ADVISED OF THE POSSIBILITY OF SUCH DAMAGES.
2. ANY OTHER DAMAGES, WHETHER INCIDENTAL, CONSEQUENTIAL OR OTHERWISE.
3. ANY CLAIM AGAINST THE CUSTOMER BY ANY OTHER PARTY.

Effect of state law:

This warranty gives you specific legal rights, and you may also have other rights which vary from state to state. Some states do not allow limitations on implied warranties and/or do not allow the exclusion of incidental or consequential damages, so the above limitations and exclusions may not apply to you.

Sales outside the U.S.A. and Canada:

For warranty information and service on ViewSonic products sold outside of the U.S.A. and Canada, contact ViewSonic or your local ViewSonic dealer.

* **For Europe:** This Limited Warranty is effective in Europe for two (2) years for all parts (except software) and two (2) years for all labor from the date of the first consumer purchase.

ViewSonic Pocket PC Warranty (V1.0)

Release Date: September 9, 2002

Specifications

Processor	Processor Speed Cache	Intel X-Scale PXA255 400 MHz 32 KB Data, 32 KB Instruction
Memory	RAM ROM	64 MB SDRAM (36 MB user-accessible) 64 MB NAND Flash memory
Operating System		Microsoft Pocket PC 2002 Premium Edition
LCD	Screen Type Luminance Backlight Resolution Screen Size Colors	Transflective TFT 50 Cd/m ² (Nits) typical 6 LEDs 320 x 240 3.5 inches Up to 64K colors
Video Chip		Integrated with X-Scale PXA250
Audio	Features	Voice Recording (Mono) MP3 Playback support
SD Card Slot		Supports SD memory and SDIO Now! compatible card
Input/Output	Touch Panel Input Method Microphone Speaker Headphones USB Infrared Serial Cradle AC/DC	Resistive Touch Panel Stylus pen, On-Screen keyboard, and Handwriting recognition software Built-in (mono) Built-in 3.5 mm mini jack USB 1.1 (Client) for ActiveSync IrDA (SIR, 115.2 kbps) UART 16650 for ActiveSync 22 pin cradle connector 5 V, 1 A, DC jack
Indicators	Color LED	Amber -- charging Red (blinking) -- notification
Power	Battery AC Adapter	Lithium Ion, 900 mAh Active Mode: up to 8 hours (Backlight Off) Suspend Mode: approx. 14 days Replace battery at service center. NOTE: memory state is maintained for approx- imately 72 hours after low battery shut-down. Input: 100~240 VAC 50~60 Hz Output: 5 V DC, 1 A Recharge: 2.5 hours (100%) NOTE: AC adapter can be connected to main unit or cradle.
Dimensions	Physical (Pocket PC V37)	121.8 mm (H) x 76.8 mm (W) x 13.2 mm (D) 4.8" (H) x 3.02" (W) x 0.52" (D)
Weight	Net	139 g (4.9 oz.)
Operating Conditions	Temperature Humidity	32° F to 104° F (0° C to +40° C) 20% to 90% RH
Storage Conditions	Temperature Humidity	14° F to +140° F (-10° C to +60° C) 20% to 90% RH
Regulations		UL/cUL, FCC Part 15 B, CE, TUV/GS, BSMI, VCCI, C-tick, CCC

Data Loss Disclaimer

Before sending the V37 out for service, be sure to backup all data and remove all third party software.

With respect to all service provided, it is your responsibility to backup the contents of your V37, including any data you have stored or software you have installed on the V37. It is likely that the contents of your V37 will be lost in the course of service and ViewSonic will not be responsible for any damage to or loss of any programs, data or other information stored on any media or any part of any Product serviced hereunder.

IF DURING THE REPAIR OF THE PRODUCT THE CONTENTS OF THE V37 ARE ALTERED, DELETED, OR IN ANY WAY MODIFIED, VIEWSONIC IS NOT RESPONSIBLE WHATSOEVER. YOUR PRODUCT WILL BE RETURNED TO YOU CONFIGURED AS ORIGINALLY PURCHASED (SUBJECT TO AVAILABILITY OF SOFTWARE).

Be sure to remove all third party hardware, software, features, parts, options, alterations, and attachments not warranted by ViewSonic prior to sending the product to ViewSonic for service. ViewSonic is not liable for any loss or damage to these items.

ViewSonic Corporation

A-CD-PPCV37-UG

English 04-01-03