

EURODESK®

MX3282A

User's Manual

Version 1.1 March 2001

ENGLISH

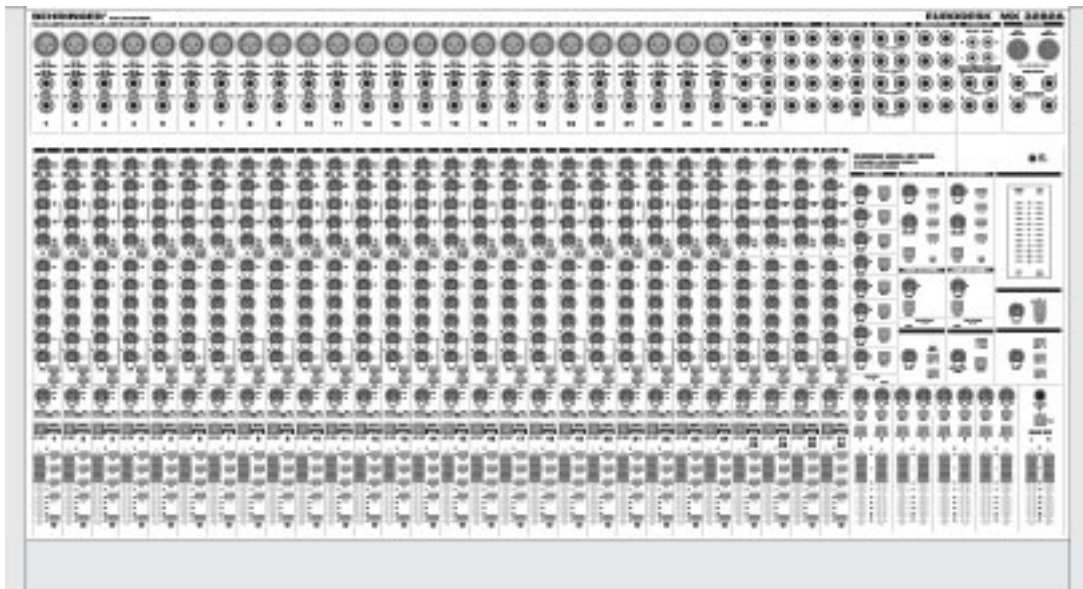

www.behringer.com

SAFETY INSTRUCTIONS

CAUTION: To reduce the risk of electrical shock, do not remove the cover (or back). No user serviceable parts inside; refer servicing to qualified personnel.



WARNING: To reduce the risk of fire or electrical shock, do not expose this appliance to rain or moisture.



This symbol, wherever it appears, alerts you to the presence of uninsulated dangerous voltage inside the enclosure - voltage that may be sufficient to constitute a risk of shock.



This symbol, wherever it appears, alerts you to important operating and maintenance instructions in the accompanying literature. Read the manual.

DETAILED SAFETY INSTRUCTIONS:

All the safety and operation instructions should be read before the appliance is operated.

Retain Instructions:

The safety and operating instructions should be retained for future reference.

Heed Warnings:

All warnings on the appliance and in the operating instructions should be adhered to.

Follow instructions:

All operation and user instructions should be followed.

Water and Moisture:

The appliance should not be used near water (e.g. near a bathtub, washbowl, kitchen sink, laundry tub, in a wet basement, or near a swimming pool etc.).

Ventilation:

The appliance should be situated so that its location or position does not interfere with its proper ventilation. For example, the appliance should not be situated on a bed, sofa rug, or similar surface that may block the ventilation openings, or placed in a built-in installation, such as a bookcase or cabinet that may impede the flow of air through the ventilation openings.

Heat:

The appliance should be situated away from heat sources such as radiators, heat registers, stoves, or other appliance (including amplifiers) that produce heat.

Power Source:

The appliance should be connected to a power supply only of the type described in the operating instructions or as marked on the appliance.

Grounding or Polarization:

Precautions should be taken so that the grounding or polarization means of an appliance is not defeated.

Power-Cord Protection:

Power supply cords should be routed so that they are not likely to be walked on or pinched by items placed upon or against them, paying particular attention to cords and plugs, convenience receptacles and the point where they exit from the appliance.

Cleaning:

The appliance should be cleaned only as recommended by the manufacturer.

Non-use Periods:

The power cord of the appliance should be unplugged from the outlet when left unused for a long period of time.

Object and Liquid Entry:

Care should be taken so that objects do not fall and liquids are not spilled into the enclosure through openings.

Damage Requiring Service:

The appliance should be serviced by qualified service personnel when:

- The power supply cord or the plug has been damaged; or
- Objects have fallen, or liquid has been spilled into the appliance; or
- The appliance has been exposed to rain; or
- The appliance does not appear to operate normally or exhibits a marked change in performance; or
- The appliance has been dropped, or the enclosure damaged.

Servicing:

The user should not attempt to service the appliance beyond that is described in the Operating Instructions. All other servicing should be referred to qualified service personnel.

FOREWORD

Dear Customer,

Welcome to the team of EURODESK users and thank you very much for expressing your confidence in BEHRINGER products by purchasing the MX3282A.

It is one of my most pleasant tasks to write this letter to you, because it is the culmination of many months of hard work delivered by our engineering team to reach a very ambitious goal: creating an outstanding device that will become a standard tool used by studios and PA companies. The task to design the MX3282A certainly meant a great deal of responsibility, which we assumed by focusing on you, the discerning user and musician. It also meant a lot of work and night shifts to accomplish this goal. But it was fun, too. Developing a product usually brings a lot of people together, and it really is a great feeling when everybody who participated in such a project can be proud of what we've achieved!

It is our philosophy to share our joy with you, because you are the most important member of the BEHRINGER family. With your highly competent suggestions for new products you've greatly contributed to shaping our company and making it successful. In return, we guarantee you uncompromising quality (manufactured under ISO9000 certified management system) as well as excellent technical and audio properties at an extremely affordable price. All of this will enable you to fully unfold your creativity without being hampered by budget constraints.

We are often asked how we are able to produce such high-grade devices at such unbelievably low prices. The answer is quite simple: it's you, our customers! Many satisfied customers means large sales volumes enabling us to get better conditions of purchase for components, etc. Isn't it only fair to pass this benefit back to you? Because we know that your success is our success too!

I would like to thank all people whose help on "Project MX3282A" has made it all possible. Everybody has made very personal contributions, starting from the designers of the unit via the many staff members in our company to you, the user of BEHRINGER products.

My friends, it's been worth the trouble!

Thank you very much,

A handwritten signature in black ink, appearing to read 'U. Behringer', with a long horizontal flourish extending to the right.

Uli Behringer

EURODESK®

Professional 32-channel 8-bus recording & live-mixing console in ultra low-noise design

- ▲ 32 microphone/line inputs, 24 mono and 4 stereo
- ▲ Ultra low-noise, discrete microphone preamps with +48 V phantom power and switchable low-cut filter
- ▲ 32 balanced line inputs and 24 balanced XLR microphone inputs with gold-plated contact surface
- ▲ 8 subgroups equipped with independent panpots, separate soloing, main mix switches and individual insert sockets
- ▲ 8 master aux sends with gain control and soloing function
- ▲ 4 multifunctional stereo aux returns featuring individual level and pan controls, solo and routing switches
- ▲ Ultra-musical original EURODESK 4-band EQ (stereo channels) and 3-band EQ with semi-parametric mids (mono channels)
- ▲ 4 pre/post fader switchable aux sends, two permanent pre fader and two permanent post fader located aux sends for maximum flexibility of monitoring functions and effects routing
- ▲ Insert facility on every single mono channel, subgroup and main channel
- ▲ Clear and easy comprehensible designed as split console, input and main sections divided
- ▲ State of the art 4580 ICs and high-quality components guarantee crystal-clear audio performance and excellent noise figures
- ▲ RCA sockets for 2-track recorders (input and output), input assignable to main mix or monitor
- ▲ Extremely high headroom—offering more dynamic range
- ▲ External power supply design provides endless power resources, superior transient response and humfree audio
- ▲ Balanced inputs and main outputs for highest possible signal quality
- ▲ LED indicators for mute, solo in place and PFL-solo functions
- ▲ Individual outputs for main mix, control room and headphones
- ▲ Extremely versatile headphones and talkback section
- ▲ High-precision, 8-digit LED metering device for input channels, main mix and subgroups
- ▲ Highest quality faders for main mix, channels and subgroups as well as sealed potentiometers
- ▲ BNC-connector for 12 V gooseneck lights
- ▲ Extremely rugged construction ensures long life even under the most demanding conditions
- ▲ Manufactured under ISO9000 certified management system

TABLE OF CONTENTS

1. THE MANUAL	7
1.1 Warranty	7
1.2 Nomenclature	7
1.3 Key	7
2. EURODESK OVERVIEW	8
2.1 Architecture	8
2.2 Metering	8
2.3 Power Supply Unit (PSU)	9
3. MONO INPUT CHANNELS	9
3.1 Input Level Setting	9
3.2 Equalizer	10
3.3 Aux Sends	10
3.4 Routing & Muting	10
4. STEREO INPUT CHANNELS	11
4.1 Input Level Setting	11
4.2 Equalizer	11
4.3 Aux Sends	11
4.4 Routing & Muting	11
5. SUBGROUPS AND INSERTS	12
5.1 Subgroups	12
5.2 Insert Points	12
6. MAIN SECTION	14
6.1 Aux Masters	14
6.2 Monitoring	15
6.3 Headphones	15
6.4 Solo/PFL	15
6.5 2-Track Input and Output	15
6.6 Talkback	16
7. CONNECTIONS	16
7.1 EURODESK MX3282A Back Panel	16
7.2 Patchfield and Plug Wiring Scheme	16
7.2.1 Soldering Guide	17
8. SETTING UP	19
8.1 Selecting Inputs	19
8.2 Initializing Channels for Gain Setting	19
8.3 Auditioning a Signal and Setting Up a Channel	19
8.4 Desk Normalization	20
9. PATCHBAY	20
9.1 Parallel	20
9.2 Half-normalled	20
9.3 Normalled	21
9.4 Open	21
9.5 Patchbay Organization	21
9.6 Looming Problems	23

10. APPLICATIONS	23
10.1 Keyboard Submixing	23
10.2 Live Concert with Simultaneous 8-Track Recording	23
10.3 8-Track Studio Recording	25
10.4 16-Track Studio Recording	27
10.5 Multitrack Initialization	28
10.6 Recording Levels	29
10.7 Track Sheet	29
10.8 Auditioning a Mix	29
11. TECHNICAL BACKGROUND	29
11.1 Mixing	29
11.1.1 Equalization	29
11.1.2 Gain Optimization	30
12. EXPANDING	30
13. MODIFICATIONS	31
14. SPECIFICATIONS	32
15. WARRANTY	33

1. THE MANUAL

Thank you for expressing your confidence in us and our work by purchasing the EURODESK MX3282A. Our first task in writing this manual is to make you feel comfortable with the special terms that are used to describe your EURODESK MX3282A and its proper use.

 **Reading this manual will make you aware of the many possibilities the EURODESK MX3282A offers you. Please keep this manual safely for future reference.**

1.1 Warranty

Please take the time to have the warranty card filled out completely, and return it within 14 days after the date of purchase, so as to be entitled to benefit from our extended warranty. You may also use our online registration option available on the Internet at www.behringer.com. You will find the serial number of your MX3282A on the rear panel.

Your EURODESK was carefully packed in the factory and the package was designed to protect the unit from rough handling. Nevertheless, we recommend that you carefully examine the packaging and its contents for any signs of physical damage, which may have occurred while shipping.

 **If the unit is damaged, please do NOT return it to us, but notify your dealer and the shipping company immediately, otherwise claims for damage or replacement may not be granted. Shipping claims must be made by the consignee.**

 **Before you connect your EURODESK and its external power supply unit (PSU) to the mains, please make sure that your local voltage matches the voltage required by the unit. On the PSU's rear panel you will find the information required (see chapter 2.3).**

 **The PSU and the mixing console are getting warm while in use. This is a normal effect and no reason to worry.**

 **Operation and installation of the EURODESK and connected studio equipment should only be done by qualified personnel. Always be sure that operating personnel is sufficiently earthed to avoid trouble caused by electrostatic charge.**

1.2 Nomenclature

Most specialist subjects are not really all that difficult provided you understand the language used, and the vocabulary of mixing is pretty straight-forward. Nevertheless it is as well to be clear about what certain terms mean. A "slot" in a recorder will always be referred to as a track, while that in a mixer will invariably be a channel. A group will always refer to a sub-mix of channels. Similarly the term band will be mentioned only in conjunction with frequency.

1.3 Key

On a separate sheet you will find some pages with drawings showing the front, the connector panel and the rear panel of your EURODESK. Always keep them available while studying this manual.

All EURODESK functions will be numbered consistently throughout the manual, whether they be in the text or in an illustration.

2. EURODESK OVERVIEW

2.1 Architecture

The MX3282A is a conventional split console. By this we mean that the inputs and outputs occupy separate areas of the board. This makes for easier visualization of signal path compared to an in-line design, which uses combined input/output channels. The main section on the right hand side handles all the outputs (as well as 4 stereo aux returns and a 2-track tape input), input channels are located on the left.

The configuration is 32 into 8 into 2. This means that there are 32 channel inputs in total (there are 24 mono and 4 stereo channels), assignable to 8 subgroup buses (plus the main mix) which in turn may be blended into the main mix stereo output. The subgroups (configurable as stereo pairs if required) are provided for connecting to a multitrack tape recorder, or for use as a mixing aid during mix-down or during a live concert. Every channel, and two out of four stereo aux returns included in the MX3282A can access any or all of these subgroups, or the main mix directly, via comprehensive routing matrices. All channels also have access to eight aux send buses. Each channel can access 6 aux sends simultaneously. For each channel the 8 aux sends are switchable between two configurations: six pre- and two post-, or six post- and two pre-fader, for live or studio operating environments respectively.

Input channels

The first 24 input channels are mono, with a choice of balanced mic (XLR, +48 V phantom power switchable) or line (1/4" TRS) inputs, both with exceptional gain architecture. A further 8 line inputs are configured as 4 stereo input channels, accepting all line level signals. Every channel has MUTE, SOLO/PFL and comprehensive EQ. A high-quality 60 mm fader feeds the main mix and/or subgroup buses via subgroup- and mix-assign switches. A constant-power channel PAN also selects between odd and even-numbered subgroup buses.

Subgroups

For ease and flexibility of mixing, eight mono subgroups with PAN and SOLO are provided. Each has its own individual output, and each may also be assigned to the main mix.

Aux sends

There are eight master aux send outputs, each with SOLO and GAIN.

Aux returns

Four line-level stereo aux returns, each with SOLO and GAIN, are located above the subgroup faders. Note that AUX RETURNS 1 and 2 are assignable to any mix bus.

Stereo aux returns

At the main sections top end (middle) you will find four stereo aux returns, each with SOLO and LEVEL control. AUX RETURN 3 and 4 are hard-wired to the main mix, while AUX RETURNS 1 and 2 can be switched to either main mix or the subgroups and therefore are equipped with a BALANCE control.

Main mix output / additional features



Main mix output level is being controlled via a pair of high-quality 60 mm faders. The main section also includes an assignable headphones output with LEVEL, a 2-track tape return assignable to the control room/monitors, and a solo output, adjustable for audition level and switchable between the solo and PFL function. The monitor (or control room) output is independently adjustable for level, and the integral TALKBACK mic is routable to 6 of the 8 aux buses, i.e. all possible pre-fader (cue) sends. A BNC connector is provided for a gooseneck lamp for those dark winter's night mixes.

Inserts

Mono channels, subgroups and the main mix all have insert points for patching in dynamics processors etc.

2.2 Metering

All input channels have signal and overload LEDs, while the L and R output has a pair of 12 digit bargraph meters. The main mix (L/R) meters also have clip LEDs (+28/22 dB: balanced/unbalanced), and double up as mono PFL or stereo solo meters, or 2-track return meters (in general, what you hear is what you see). During Solo/PFL only the main mix bargraph meters illuminate.

-  **The master clip LEDs (+22 dBu) should never be allowed to illuminate. If they do, reduce either the MAIN MIX fader or the group(s) and/or channel fader(s), or (as a last resort) the channel input gain(s). Maybe it's time to do a round of PFL metering.**
-  **In Solo/PFL mode a 0 dB meter reading matches an internal operating level of 0 dBu (0.775 V). However, when looking at the mix, 0 dB is referenced to +4 dBu, the 2-track operating level. I.e. if only one signal is present in the main mix bus, soloing that signal will cause the meter reading to increase by +4 dB.**

2.3 Power Supply Unit (PSU)

Any amplifier circuit is limited in its transient response by the available current. In common with most desks of this size, the EURODESK has several hundreds of line level operational amplifiers (op-amps) inside. When being driven hard, many desks begin to show signs of stress due to power supply limitations. Not so with the EURODESK. Due to the vast power resources of its external power supply unit, the sound should stay clean and crisp and tight right up to the operating limits of the op-amps themselves.

The EURODESK remote PSU connects to the desk at the rear of the console via a multiway connector. Give an extra 1/2 U of rack space to allow air to circulate around the heatsinks employed for heat dissipation. The EURODESK PSU chucks out a massive 100 Watts.

Please note:

On the rear of your PSU you will find the mains connector / fuse holder / voltage selector. Before you connect the unit, please make sure that the displayed voltage corresponds to your mains supply.

If you intend to change the operating voltage, remove the fuse holder and twist it by 180 degrees before you re-insert it. Matching the two markers indicates the selected voltage.

Note that the **correct fuse type and rate** must be installed corresponding to the mains voltage.

Connect the PSU to the mains power supply by the enclosed mains cable, then use the mains switch to power up your power supply unit and EURODESK.

-  **Never connect or disconnect your EURODESK and power supply unit when the power supply unit is "on"! Always start connecting your MX3282A to the PSU, check if the PSU is turned "off", plug into mains and then power up the PSU and thereby your EURODESK.**

3. MONO INPUT CHANNELS

Each channel comes with a balanced line input on 1/4" TRS jack, and an XLR mic input. Press the PHANTOM switch [2] at the back panel if required. The mic amp circuit has an unusually wide gain range [6] from 10 dB to 60 dB, is of extreme low-noise design, and utilizes high-current conjugate pair vintage transistor circuitry to deliver an incredibly warm and transparent sound.

When a jack is plugged into the balanced (self-unbalancing) line input, the gain structure is such that it can match any line level from +10 to -40 dBu. The crucial operating levels +4 dBu and -10 dBV are clearly and accurately legended ([6]).

3.1 Input Level Setting

Channel input level is determined by the GAIN trimpot [6]. Use SOLO/PFL [18] to accurately monitor the channel input on the left/right master output bargraph meters. This also sends the Solo/PFL-ed signal to the left and right speakers. Channel SOLO [18] has an associated LED [19].

-  **For level-setting (as opposed to localized listening) choose to use the Mono PFL bus rather than the post-fader (post-channel pan) stereo solo bus (CHANNEL MODE switch [46] not depressed). SOLO/PFL never interrupts the mix at the main recording outputs. It follows that aux sends and subgroups must also be unaffected, since they contribute directly to the main mix.**

In addition to switchable Solo/PFL metering, a couple of channel LEDs ([15] / [16]) illuminate when a signal is present (-20 dB), or if a channel is going into overload. These LEDs are particularly useful when using extreme EQ settings, or adding a dynamics processor via an insert.

You do not want the overload light to come on except very intermittently during a take or a mix. If it does light persistently, reduce input gain (see also the essential section 8: "SETTING UP").

3.2 Equalizer

All mono input channels are fitted with a semi-parametric 3-band EQ, plus a switchable low-cut filter for eliminating unwanted subsonics. The upper [8] and lower [11] shelving controls have their frequencies fixed at 12 kHz and 80 Hz respectively. The midrange control [9] is semi-parametric with a peaking response, Q fixed at 2 octaves, sweepable from 100 Hz - 8 kHz ([10]). All three bands have up to 15 dB of cut and boost, with a center detent for "off". Thirdly, there is a steep high pass (low-cut) filter [7], slope @ 18 dB/oct, for reducing floor rumble, breath noise and popping, woolly bottom end etc.

 **The combination of shelf boost at 80 Hz together with low-cut at 75 Hz results in a peaking response, useful for adding warmth to vocals and instruments, and a firm bottom to kick drums and basses, without losing control of low frequency speaker cones.**

3.3 Aux Sends

All eight aux sends [12] are mono and post-EQ. Aux sends 1 & 2 are fixed to be pre-fader for cueing purposes, while 3 & 4 are fixed post-fader for sending to effects etc. A SHIFT switch [13] toggles the third pair of aux send potentiometers between two bus pairs (5 & 6 or 7 & 8). These four aux sends are switchable pre/post-fader *en bloc* using the PRE switch [14].

For almost all FX send purposes, you will want aux sends to be post-fader, so that when a fader level is adjusted, any reverb send from that channel follows the fader. Otherwise, when the fader is pulled down, the reverb from that channel would still be audible. For cueing purposes, aux sends will usually be set pre-fader, i.e. independent of the channel fader (depress PRE switch [14] for aux sends 5/6/7/8).

 **Most reverbs etc. internally sum up the left and right inputs. The very few that do not may be driven in true stereo by using 2 aux sends.**

There is +15 dB of gain on every aux send. Such a high boost is usually only appropriate where the channel fader is set around -15 dB or lower. Here, an almost exclusively wet signal will be heard. In most consoles, such a wet mix requires the use of a pre setting for the channel aux send, losing fader control. With the EURODESK you can have a virtually wet mix with fader control.

Channels may be altered for pre-EQ aux sends (see section 13: "MODIFICATIONS").

3.4 Routing & Muting

Routing means selecting which bus you want a channel to address. There are five stereo buses in the EURODESK MX3282A (plus a stereo solo bus). Main mix and the four subgroup pairs are selected by five assign switches [22]. Solo/PFL we encountered in the section on input level setting (3.1).

Channel PAN [17] positions the output of the channel in the stereo field. Its constant-power design ensures there are no level discrepancies whether a signal is hard-panned, center-stage, or somewhere in-between. Such pin-point accuracy will be a revelation if you have been working on consoles with lower quality circuits.

All stereo buses follow channel PAN. Usually, only one of L-R, 1-2, 3-4 etc. will be selected for a particular channel.

 **An exception to this rule is when laying down voice takes. It is often convenient to have the mic channel(s) routed to all potential take tracks simultaneously, since you are often dropping in quickly between four or more tracks. It means one less button to press each time you switch tracks.**

Level to the group and main left and right busses is ultimately determined by the channel fader [23]. This is designed to give a smooth logarithmic taper of a type more usually associated with megabuck consoles. The low level performance particularly is far smoother than that of a “normal budget” fader.

The MUTE button [20], like that for SOLO [18] is ergonomically placed immediately above the channel fader, and has an associated LED [21] for excellent visual status indication of this much-used feature. Engaging mute is equivalent to setting a fader level of minus infinity. It follows that pre-fader aux sends are unaffected by application of mute.

4. STEREO INPUT CHANNELS

Each stereo channel comes with two line level inputs on 1/4" jacks, for left and right signals. When only the left input is connected, the channel operates in mono.

 **This feature is disabled, if the inputs and outputs of the EURODESK are wired permanently to a patchbay (see section 9: “PATCHFIELD”).**

Channel input sensitivity is variable between -20 and +20 dB by adjusting GAIN [6], enabling a perfect match with all common line-level sources including multitrack tape outputs, MIDI and other electronic instruments and effects units, all of which are normally designed to operate at either +4 dBu or -10 dBV.

4.1 Input Level Setting

This is exactly as for a mono channel (see section 3.1).

4.2 Equalizer

All stereo input channels are fitted with four-band, fixed-frequency EQ. Bands 1 and 4 are shelving, while bands 2 and 3 have a peaking response, with their Q set at 2 octaves.

The upper [8] and lower [11] shelving controls have their turnover frequencies fixed at 12 kHz and 80 Hz, whereas the midrange controls [25] and [26] have their bell center frequencies set at 8 kHz and 800 Hz.

All bands have up to 15 dB of cut and boost, with a center detent for “off”.

 **A stereo equalizer is generally preferable to using two mono equalizers when EQ-ing a stereo signal, as often discrepancies between left and right settings can occur.**

4.3 Aux Sends

These are the same as for mono channels (see section 3.3).

4.4 Routing & Muting

The only difference here from the mono channel described in 3.4 is in the implementation of the pan control. When a channel is run in mono, there is no difference at all.

In stereo operation however, this control functions as a BALANCE control [27], determining the relative balance of the left and right channel signals being sent to the left and right main mix buses, or odd and even subgroup buses. For example, with the BALANCE control turned fully clockwise, only the right portion of the channel's stereo signal will be routed to any or all of buses R, 2, 4 etc.

5. SUBGROUPS AND INSERTS

5.1 Subgroups

The principal routes to multitrack are via the subgroup outputs. There are eight mono (or four stereo) subgroups. All channels can access all of them, as can aux returns 1 and 2 ([31]). Subgroup level is determined by the SUBGROUP fader [54], while the signal level may be accurately checked by solo-ing ([52]).

Subgroup outputs can also be assigned to the main mix during mixdown by pressing the MAIN MIX switch [53], in which case stereo position in the L R mix is determined by the subgroup's PAN pot [51].

 **Try inserting compression/de-essing/an exciter or a noise gate across grouped signals (e.g. backing vocals, drums, layered synths).**

 **Try merging a dry signal with a little wet, then compressing the sum heavily. Though the reverb proportion will be low when a signal is present, the resultant reverb tail pumped up by the compressor at the start of each silence will give the illusion that the reverb was massive at the time. (The listener will be left wondering how the singer could sound so dear in such a wet acoustic!)**

5.2 Insert Points

Insert points are useful for adding dynamic processing or equalization to a channel, a group, or the mix. Unlike reverbs etc., which are usually added to the dry signal, dynamic processing is normally applied across an entire signal. Here an aux send would be inappropriate. Instead the signal is intercepted somewhere along the channel, fed through the dynamics processor and/or EQ, then returned to the console at the same point where it left. The insert point is normalized, i.e. the signal is only interrupted when a jack is plugged into it.

All mono input channels have got insert points, as have the subgroups and the main mix. Each insert point is accommodated on a single TRS jack socket wired tip = send, ring = return, sleeve = ground/screen. Inserts are always pre-fader, and also pre-EQ/pre-aux sends for channels.

 **If you want to insert a dynamics processor etc. into one of the stereo channels, it must be done between the source output and the EURODESK, as these channels have no bona-fide insert point.**

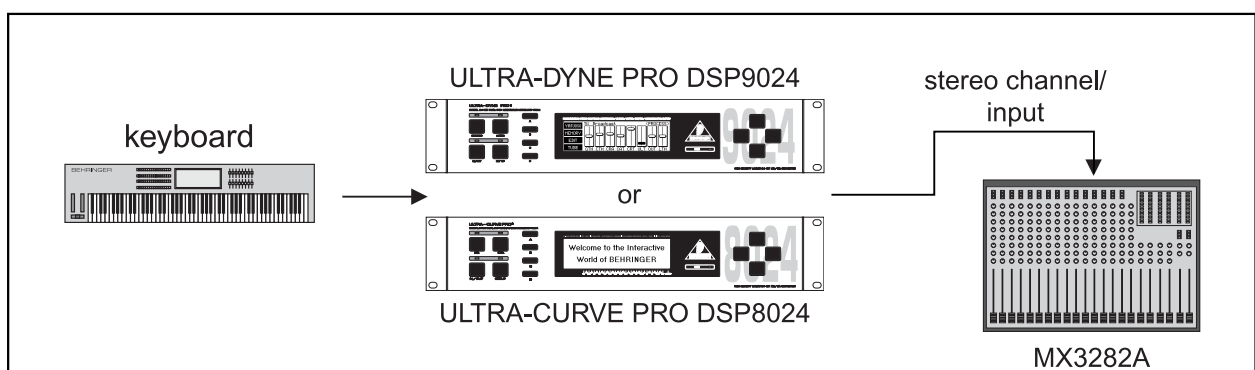



Fig. 5.1: Inserting into a stereo channel

 **Please note that we didn't draw the ground/screen connection in the following graphics to keep them as simple as possible.**

 **If you want to insert an external EQ or dynamics processor post-EQ, a subgroup insert should be used as follows:**

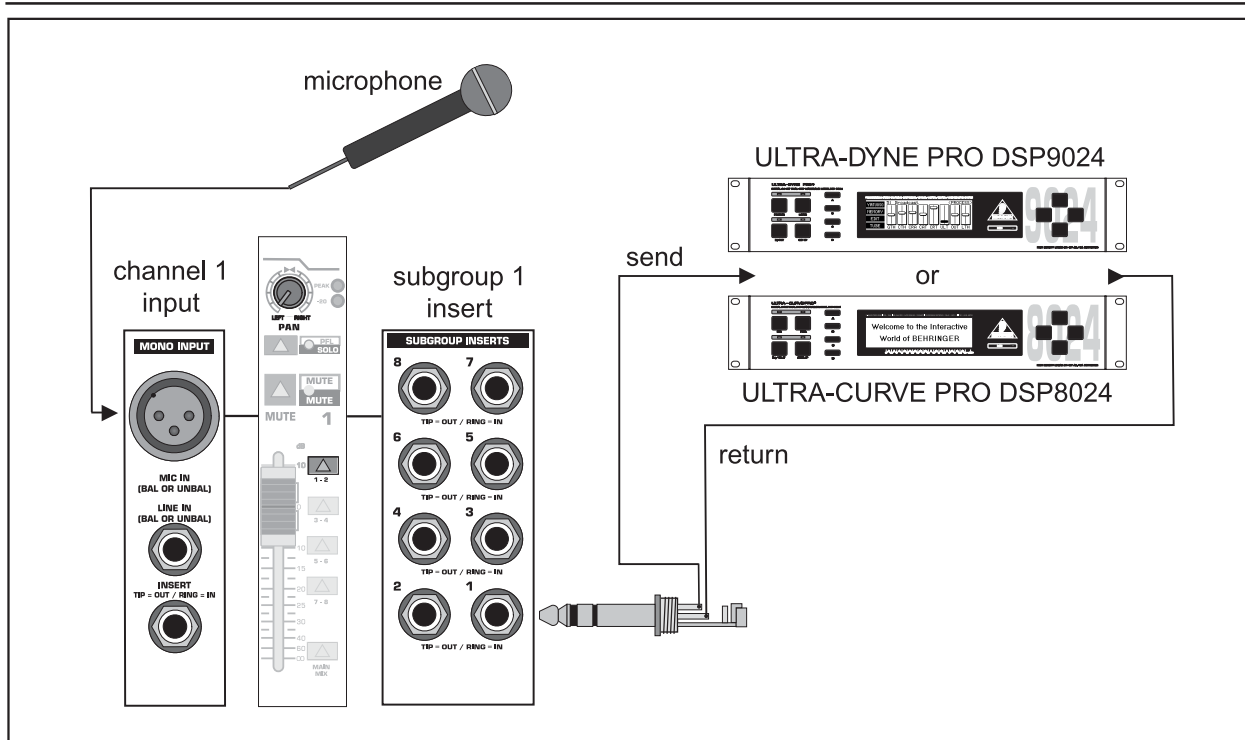

Fig. 5.2: Inserting an external EQ/dynamics processor post channel EQ

In this arrangement you might find that compression tends to soften the perceived amount of (especially treble) EQ applied. The solution here is to apply more EQ. This creates a real 'pressure' sound, great for high energy music such as dance.

In the above example, any aux sends to effects should be applied before the EQ/dynamics processing takes place. If you want the aux sends to be post-processing, you will need to address the signal to one of the subgroups and then insert the EQ/dynamics processor between the corresponding subgroup output (insert send) and a channel input (insert return).

You can now reclaim the channel 2 input as follows: By applying the channel's insert send you can route out an instrument's signal being plugged into the line input, treat it with an EQ/dynamics processor, and then reroute it via a subgroup (insert return) to the master section.

An additional patch enables channel EQ to be placed onto a subgroup with no reduction in the number of line inputs available, as well as providing an opportunity to lead a signal pre-EQ into a subgroup. By inserting a plug into the channel insert socket, the channel is interrupted between the gain pot and the EQ. A signal which is being led into the channel's mic- or line input is now guided into the subgroup inserts input. It appears to be sensible to use this signal path preferably for readily edited signals (e.g. tape tracks or post-EQ DI-outs from instruments amplifiers), as there is no EQ in the subgroup signal path.

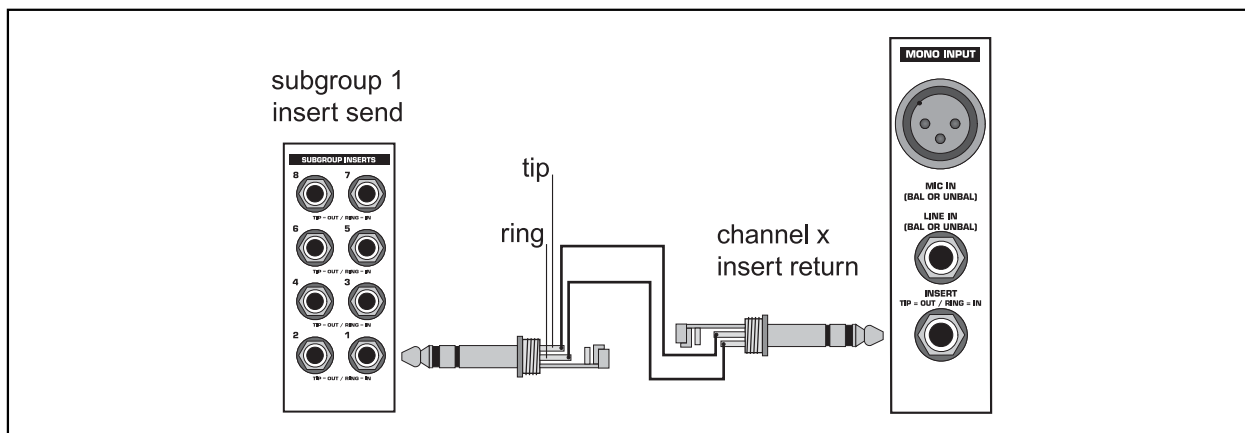



Fig. 5.3: Making use of the channel EQ for shaping subgroup-signal by applying inserts

-  EURODESK insert points are, of course, simultaneously inputs and outputs. For goodness sake, get them onto a patchbay, where they can appear as independent sockets, and do away with all these fiddly Y-teads that always seem to be the first to get knotted in the flightcase (see section 9: “PATCHBAY”). Now it is possible to do the incredibly useful patch shown in fig. 5.3 without having to make up what would amount to a ring-to-tip, tip-to-ring stereo patch lead.
-  Insert points may also be used as pre-EQ direct outputs without interrupting the signal flow. See fig. 7.1 Direct out connection.

6. MAIN SECTION

6.1 Aux Masters

Aux sends

Much of the main section (situated left and below the bargraph meters) is taken up by master aux sends and returns.

Stacked in a vertical column are eight master AUX SEND LEVEL pots [28], one for each bus. Each has a gain structure of $-\infty$ to +15 dB. The extra 15 dB of gain comes in once a knob passes a center detent (representing the ‘normal’ unity gain position), enabling insensitive outboard FX to be properly driven. Each aux send has a SOLO button [29], and, as with other areas of the mixer, a local SOLO light [35], which starts flashing when any of the aux master sends are solo-ed.

(This is to help you see exactly *what* has been solo-ed. Any experienced engineer will have had occasion to painstakingly search through *every* solo button on his / her console trying to find out why one of the main solo lights was flashing, while the control room monitors remained silent!)

Aux returns

Across from the aux sends are the stereo aux returns. These can be thought of as eight extra line inputs, configured as four stereo pairs. On these inputs there is up to 20 dB of gain available. Alternatively, a **mono** (center-panned) signal may be returned by plugging into the **left** aux return jack only.

-  **This feature is disabled if all line-level I/Os from the EURODESK are wired permanently to a patchbay (see section 9: “PATCHBAY”).**

Aux returns 1 & 2

Aux returns 1 and 2 have full group routing matrices to enable returning FX to be sent to tape, plus main mix bus assignment. The functions for aux return 1 (mirrored by aux return 2) are: routing-switches [35], LEVEL [31], BALANCE [32] and SOLO [33]. Level controls the amount of signal being blended into the mix or a group, while balance controls the relative amounts of left and right processed signal. Be sure to have BALANCE control in center-position, if you’re not actually working with it.

-  **As always, there are exceptions to the rule above. Some short stereo delay effects (say 30 ms to left, 50 ms to right) cause a psycho acoustic effect where the earlier delay seems louder. A similar effect is noticeable when harmonizing in stereo: a slight pitch shift upwards will seem louder than one that goes down. In both cases use BALANCE [32] to compensate. (An analogy comes from greece: the columns of the Parthenon in Athens are slightly bowed so as to appear straight.)**

When carrying out the setup mentioned above or any other stereo imaging exercise, don’t just rely on the control room monitors. Get a pair of headphones and listen in stereo and in reverse stereo, to allow for any hearing discrepancy between your ears.

Aux returns 3 & 4

Aux returns 3 and 4 are the poor relations, with only a LEVEL pot [36] and SOLO switch [37] each. These are always assigned to the main bus.

Solo

Below the aux returns 1/3 and 2/4 lies a local Solo LED [34]. This flashes whenever a solo button in the column above is pressed.

- 👉 **There is no absolute reason why the send from aux 1 should feed into a processor whose outputs are sent to the aux return 1. The processor could just as easily be patched into the aux return 3, or even a pair of channels. For many purposes, however, it is sensible to set up a default patch where the aux sends and returns correspond. It is logical to put your premier FX units into the aux 1 and aux 2 loops, since these returns enable you to record to tape without repatching.**
- 👉 **Sometimes an engineer wants to narrow the stereo width of a reverb field. To do this you will have to come back on channels, because they have full panorama facilities.**

6.2 Monitoring

Though most of you will want to audition the main mix most of the time there are exceptions. These include Solo/PFL and 2-TRACK playback [43]. The bargraph meters follow whatever source is being auditioned (the meters won't make much sense if more than one source is selected).

- 👉 **Altering what goes into the control room monitors does not affect the signal from the main mix recording outputs. That offers to you the opportunity to do a quick solo during a mix whenever you want without having to start again!**

The MONITOR/CTRL LEVEL pot [42] sets the level to the control room monitors. This is sourced post the main mix stereo fader setting. Your fades couldn't be heard otherwise.

Don't rely on a single pair of loudspeakers to audition your mix. You'd better use a variety of different speakers.

Lastly, there is a MONO button [44], useful for checking the phase correlation and/or coherence of a stereo signal. Again, this does not affect the main mix output.

6.3 Headphones

The headphones may be sourced from the monitor/control room mix [39], and/or from pre-fader aux sends 1/2 [40] or switchable pre/post aux sends 5/6 [41] for artist cueing. Two headphones sockets are provided on the back panel.

The headphone mix level is controlled by a LEVEL pot [38], and the gain is sufficient to drive headphones directly. This is fine for a MIDI suite with overdub booth, but for the bigger studio's headphone network using a separate headphones distribution amplifier like the BEHRINGER POWERPLAY PRO HA4600 is recommended. This can offer the added advantage of independent headphones level control for every performer.

6.4 Solo/PFL

Solo

Solo is short for Solo-in-Place, and is the preferred method for auditioning an isolated signal, or group of signals. Whenever a Solo button is pressed, all unselected channels are muted in the monitors. Stereo panning is maintained. The solo bus is derived from the output of the channel pans, aux sends, stereo line inputs and subgroups, and is always post-fader.

PFL

Pressing the channel mode switch [46] once disengages the stereo solo bus, and replaces it with a separate mono PFL (Pre-Fader Listen) bus. Now any channel which is solo-ed, isn't. It is PFL-ed instead. PFL should always be used for gain-setting.

The channel mode (PFL or Solo) is indicated by a pair of status LEDs (located below the bargraph meter [68]), pot [45] controls the solo level, which will normally be set to unity gain (center detent) to match the in-the-mix level (see also the essential section 8: "SETTING UP").

6.5 2-Track Input and Output

The 2-track input is on unbalanced RCA phono plugs, and is primarily made for auditioning mix playback from tape. The 2-TRACK switch [43] routes this signal to the control room monitors.

With the MON/CTR LEVEL control [42] fully clockwise, your 2-track input will be matched to the semi-professional level -10 dBV. For higher output recording sources (e.g. +4 dBu) turn the level of [42] down.

 **The 2-track input could usefully be connected to the output of a hi-fi pre-amp or integrated amplifier, allowing you to easily audition a variety of sources (e.g. CD, phono etc.).**

2-track output

A pair of balanced XLR and jack connectors deliver the mix output to your 2-track recorder (or PA system) at +4 dBu. Alternative RCA phono (-10 dBV) connectors are provided, too.

Level to tape is ultimately determined by precision faders [57]. Main mix insert points are provided for patching a gate, a compressor etc. pre-fader. This is important: Connecting a compressor or gate after the 2-track output would disrupt any attempt to acquiring a smooth fade using the output faders.

Although the 2-track output is primarily designed for recording, it can also be used as a PA feed, or as a send to the input of your sampler. In fact up to three simultaneous destinations can be serviced without resorting to a patchbay or splitter leads—there are three separate 2-track outputs on your EURODESK!

6.6 Talkback

The built-in flush-mounted mic [55] is activated by depressing the non-latching TALK switch [56] just above the MAIN MIX faders. Engaging talkback dims the control room monitors, (not lights!) by -20dB to avoid feedback. This does not affect the other talkback routes.

Talkback level is set by [47], and the mic can be routed to any or all of auxes 1/2, 5/6 or 7/8 ([48], [49], [50])—in other words every possible pre-fader (cue) aux send—to enable you to talk to artists remotely through their headphones or personal stage mixes.

Sometimes you will want a much higher rejection of feedback than a flush-mounted talkback mic could ever provide. When running a live concert mix, a dynamic mic plugged into a spare channel and routed to all the pre-fader sends only will do the job.

7. CONNECTIONS

7.1 EURODESK MX3282A Back Panel

DC power in

This circular multiway connector distributes the different DC operating voltages delivered by the PSU: +/-18 V (audio circuits), +48 V (mic phantom power), +12 V (lamp) and +5 V (LEDs).

Phantom power switch

When using capacitor mics, +48 V DC can be switched globally on or off by [2] (also see “Mic inputs”).

7.2 Patchfield and Plug Wiring Scheme

Most of the inputs (inserts being the major exception) are balanced. Refer to section 9 “PATCHBAY” if you are not sure what this means.

 **Unbalanced equipment may be connected to balanced inputs/outputs. Either use mono 1/4" jacks or connect ring and barrel of TRS jacks (or pin 1 and 3 of XLR plugs).**

Mono input channels 1 - 24

Insert points: unbalanced send and return on a single 1/4" TRS socket, wired tip = send, ring = return, sleeve = ground/screen.

Line inputs: balanced 1/4" TRS sockets, wired tip = hot (+ve), ring = cold (-ve), sleeve = ground/screen.

Mic inputs: XLR-type connectors, wired pin 1 = ground/screen, 2 = hot (+ve), 3 = cold (-ve), for balanced low-level operation.

 **Care should be taken NOT to plug mics into the console (or stagebox) while the phantom power [2] is on. Also mute the monitor / PA speakers when turning phantom power on or off. Allow 1 minute after powering up for the system to equilibrate before setting input gains.**

Stereo input channels 25 - 32

Four stereo pairs. Unbalanced 1/4" TRS sockets, wired tip = hot (+ve), sleeve = ground/screen.

Aux sends

Unbalanced 1/4" TRS sockets, wired tip = hot (+ve), sleeve = ground/screen.

Stereo aux returns

Four stereo pairs on balanced 1/4" sockets, wired tip = hot (+ve), ring = cold (-ve), sleeve = ground/ screen.

Subgroup inserts

For inserting into a subgroup signal. Unbalanced send and return on a single 1/4" TRS socket, wired tip = send, ring = return, sleeve = ground/screen.

Subgroup outputs

Primarily designed for feeding a multitrack recorder. Unbalanced 1/4" TRS sockets, wired tip = hot (+ve), sleeve = ground/screen.

2-track in / out

RCA sockets for use with tape recorders etc., signal = main mix. Use custom-made RCA cables for the 2-Track in/out traffic (center post = signal (+ve), sleeve = ground/screen).

Monitor & control room outputs

Will feed a pair of speakers (via an amp, of course). Balanced 1/4" TRS sockets, wired tip = hot (+ve), ring = cold (-ve), sleeve = ground/screen.

Phones outputs

Will feed two headphones. 1/4" TRS socket, wired tip = left signal, ring = right signal, sleeve = ground/screen.

Main inserts

For inserting into the main mix signal. Unbalanced send and return on a single 1/4" TRS socket, wired tip = send (out), ring = return (in), sleeve = ground/screen.

Main output (TRS sockets)

Unbalanced 1/4" TRS sockets, wired tip = hot (+ve), sleeve = ground/screen.

Main outputs (XLR)

Balanced XLR, wired pin 1 ground/screen, pin 2 hot (+ve), pin 3 cold (-ve). Maximum level is +28 dBu.

7.2.1 Soldering Guide

Fig. 7.1 shows how to solder your plugs correctly. Please read sections 7 "CONNECTIONS" and 13 "MODIFICATIONS" before you start heating your soldering iron!

 **All outputs are ground-compensated (decoupled from the mains supply earth) to eliminate the possibility of ground loops.**

 **Please make sure that every part of your equipment is connected to the mains earth. To avoid any risk of electric shock never disconnect the mains earth from any part of your equipment!**

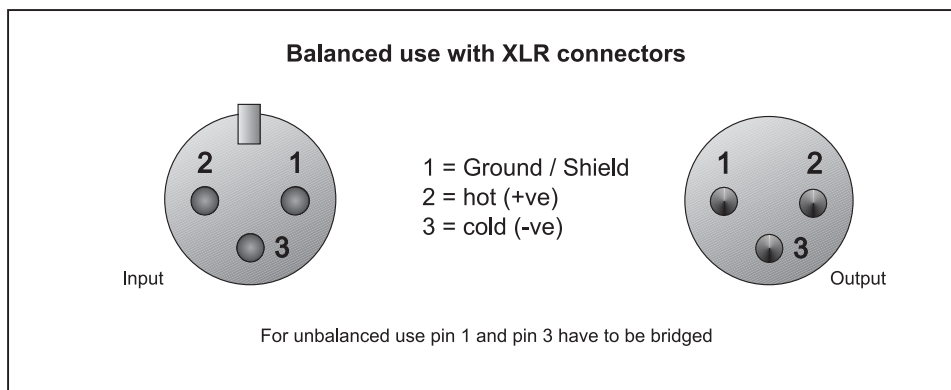
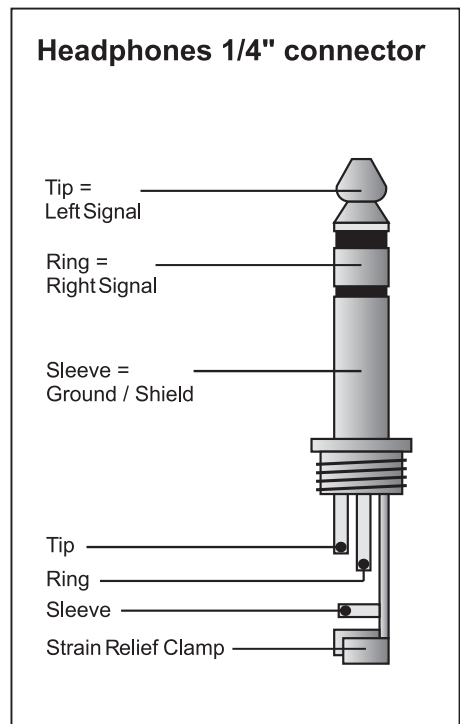
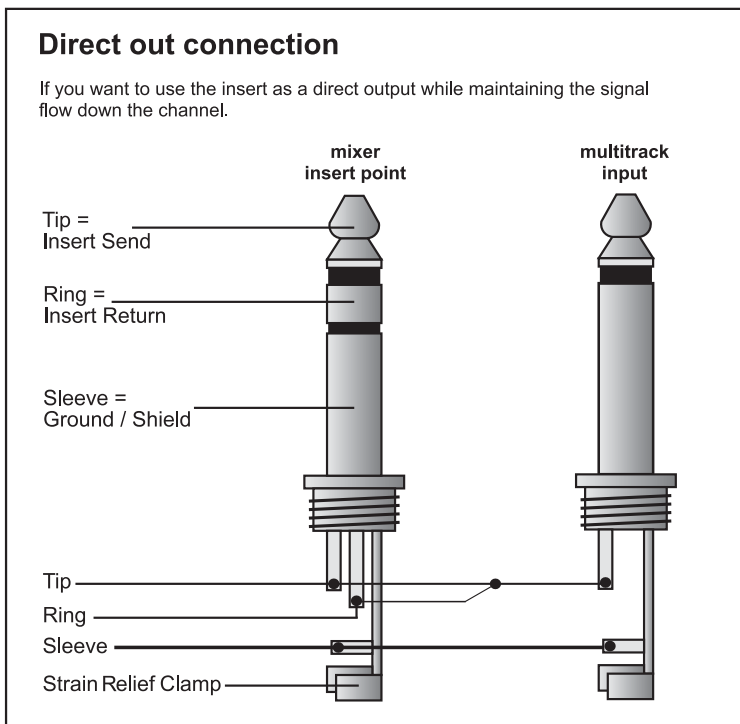
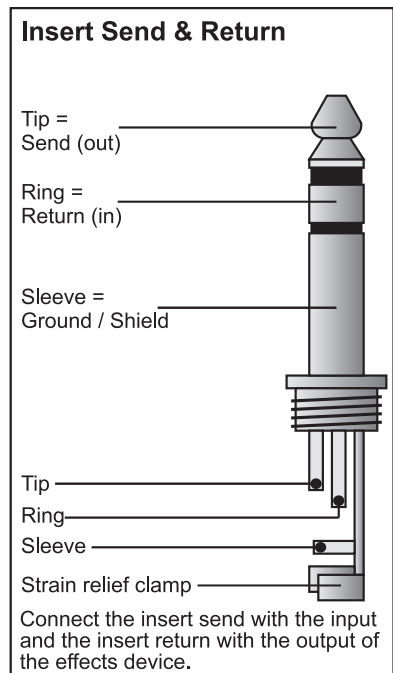
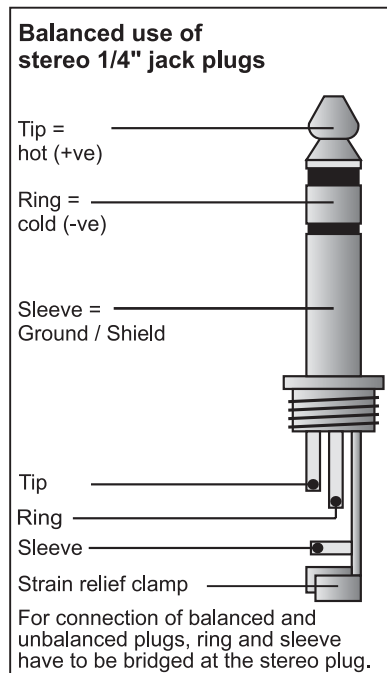
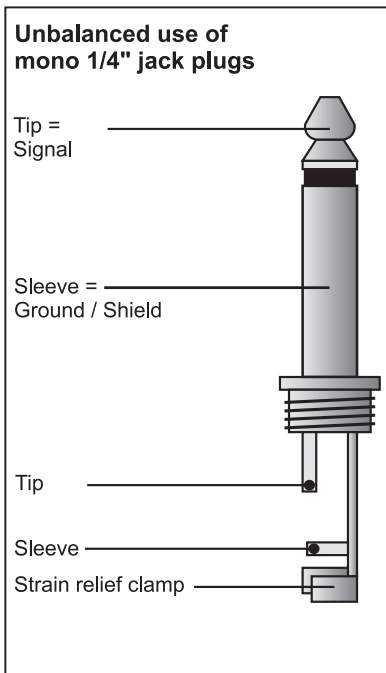



Fig. 7.1: Different plugs (overview)

8. SETTING UP

8.1 Selecting Inputs

1) Mono channels accept mic or line inputs.

If you are using the mic input, make sure nothing is connected to the line input (and vice-versa). Please note that mic inputs are many times more sensitive than line inputs!

 **Do not connect mics with phantom power switched on. NEVER use unbalanced mic cables with the phantom power switched on ever! Shorting +48 V DC to earth can cause serious damage.**

2) Stereo channels accept line level signals. Any stereo channel can be run in mono simply by connecting into the left jack socket only.

 **This feature is disabled if all line level in-/outputs from the EURODESK are wired permanently to a patchbay (see section 9 “PATCHBAY”).**

The stereo channels are suitable for a variety of line-level sources including MIDI instruments, effects outputs, and tape returns from multitrack.

3) Stereo aux inputs are primarily designed for returning effects units, though these too may be given over to multitrack returns or MIDI instrument outputs.

8.2 Initializing Channels for Gain Setting

1) Set gain to minimum and all aux sends to “off” (fully counterclockwise).

2) Set EQ to flat (all knobs at 12 o'clock).

3) Where applicable, set LO CUT switch 7 on for most mics, off for signals with desired very low frequency content.

4) Set CHANNEL MODE to PFL (46 up).

5) Depress SOLO switch 18.

8.3 Auditioning a Signal and Setting Up a Channel

1) Make a typical noise, or roll the tape. There should now be some activity at the main bargraph meters, indicating the PFL level.

2) Adjust the GAIN control 6 until transient peaks are regularly hitting +2 dB. Continuous signals should not exceed 0 dB.

3) With FX units, MIDI instruments and multitrack tape recorders (pro +4 dBu, semi-pro -10 dBV), it is important to match the operating level of the desk to that of your machine. If you are not sure which level your external equipment requires, try a 0 dB setting first. If the signal is too low, turn the GAIN pot to the right.

 **A -10 dBV nominal operating level for an effects processor is almost certainly referenced to 0 dB on the unit's input or output meter. If the FX processor has indication only for input level, ensure that the output gives comparable, i.e. 'unity', gain.**

4) If EQ is adjusted at any time, repeat steps 8.3 1) & 2).

5) If an insert is used to patch in a compressor, gate, EQ etc., use the outboard processor's bypass or effect off switch to A/B monitor the effected and bypassed signals, which should be level matched. (If the unit does not have a bypass switch or equivalent, you will have to keep connecting and disconnecting the device until you achieve unity gain.)

6) SOLO switch 18 up. Move onto next channel.

8.4 Desk Normalization

All board settings should be set to the normal default condition before or after every session. Usually faders are set to zero (minus infinity) EQs set flat, trimpots and channel aux sends turned fully anticlockwise etc. Many controls have a natural initial setting. For EQ cut and boost this is unity gain. However, some settings, such as selecting pre or post for channel aux sends, will depend on the operating environment (e.g. studio or live), or on a particular engineer's preferred way of working.

9. PATCHBAY

A patchbay allows to patch the audio signals of most components in your studio from a central point and send them to other units, which makes your entire cabling better structured and is indispensable for professional work. If you want to use your studio as effectively as possible then it is preferable to use a complete patchbay wiring scheme. But even smaller studio configurations will benefit from less sophisticated patchbay solutions.

The majority of commercially available patchbays include two rows with 24 phone jacks each in a 19" 1 U rack panel. On the rear, either a corresponding number of phone jacks or contacts for soldering signal leads can be found. Each group of four of these phone jacks forms one module. The configuration of some Patchbays can be changed by inserting jumpers or turning individual modules.

With the help of our ULTRAPATCH PRO PX2000, an easy-to-use 24-patchbay offering phone jacks throughout, you can easily understand the four different modes. With the ULTRAPATCH PRO you can select between the four different operating modes simply by setting a switch on the upper panel (example: module 17):

9.1 Parallel

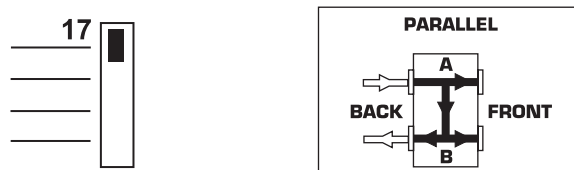

Fig. 9.1: Patchbay mode "parallel"

In this mode, all terminals of one module are interconnected. This configuration doesn't make sense at first glance but is used to split up and send *one* audio signal (e.g. aux send) to several destinations (e.g. effects devices).

9.2 Half-normalled

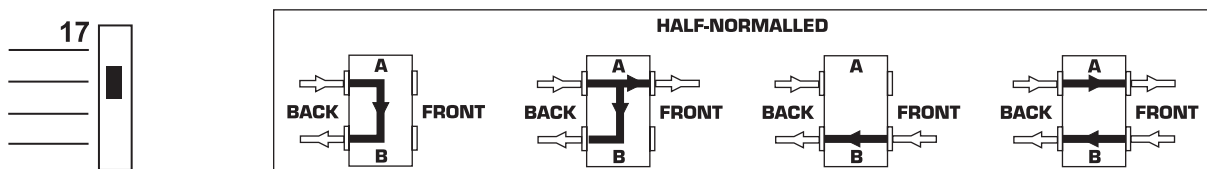

Fig. 9.2: Patchbay mode "half-normalled"

In this configuration, the contacts of the two jacks on the rear are interconnected. When you insert a plug into the upper front jack, the signal routed through the rear path is not interrupted. Only when the lower front jack is used will the rear panel route be split up, so that the two upper and the two lower phone jacks are connected to one another. This configuration is called "input break" and is used mainly for insert paths. So you can easily patch the signal from a mixing console channel at the Patchbay without interrupting the signal flow in the channel.

9.3 Normalled

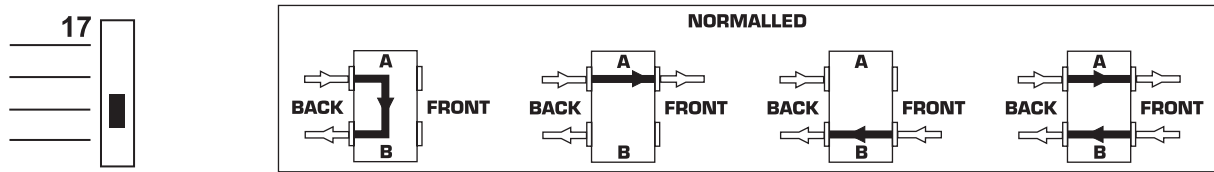

Fig. 9.3: Patchbay mode "normalled"

Here, and in contrast to the "half-normalled" setup, the signal route of the rear phone jacks is interrupted when you insert a plug both into the upper and lower front jacks.

9.4 Open

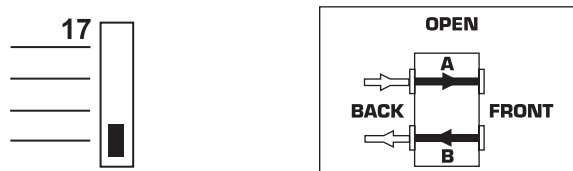

Fig. 9.4: Patchbay mode "open"

This mode is used to connect devices such as sound modules or CD players having no inputs of their own. This saves space, as you can route the left and right outputs to one module (left - top; right - bottom) or patch two devices to one module (top and bottom). Effects devices and 2-tracks can be configured this way, so the inputs and outputs are positioned on top of each other.

Basically, the inputs are routed to the bottom and the outputs to the top rear-wall connectors. Avoid routing digital signals over a patchbay as the pulse signal used for the transmission of such signals causes heavy interference in analog signals. Additionally, normal patchbays change the impedance of the digital cable route, which causes interference in the digital path. Use the BEHRINGER ULTRAMATCH SRC2000 specifically designed for this and other digital signal-related functions.

Microphone inputs operate at a level several orders of magnitude lower than line levels (+4 dBu or -10 dBV). Therefore, they should never be routed via a patchbay. In any case, patching in a field with 48 V DC (phantom power) flying about is to be avoided at all costs. It is best to plug mics directly into the mixing console or via special XLR-type wall boxes connected to the mic inputs of the console by good-quality balanced multicore cables (2-cond. + shield).

9.5 Patchbay Organization

Let us give you an example configuration that shows how you can most effectively use your patchbays. We assume you own a mixing console with 16 mic/line inputs plus inserts, 8 direct outputs, 8 subgroups with 4 inserts, 4 aux paths with 2 stereo returns and one stereo master output including insert jacks. Added to this we have an 8-track recorder (digital or analog), a few pieces of outboard equipment (FX, dynamics & EQ's), a CD player, tape deck, HiFi system and a headphones amp:

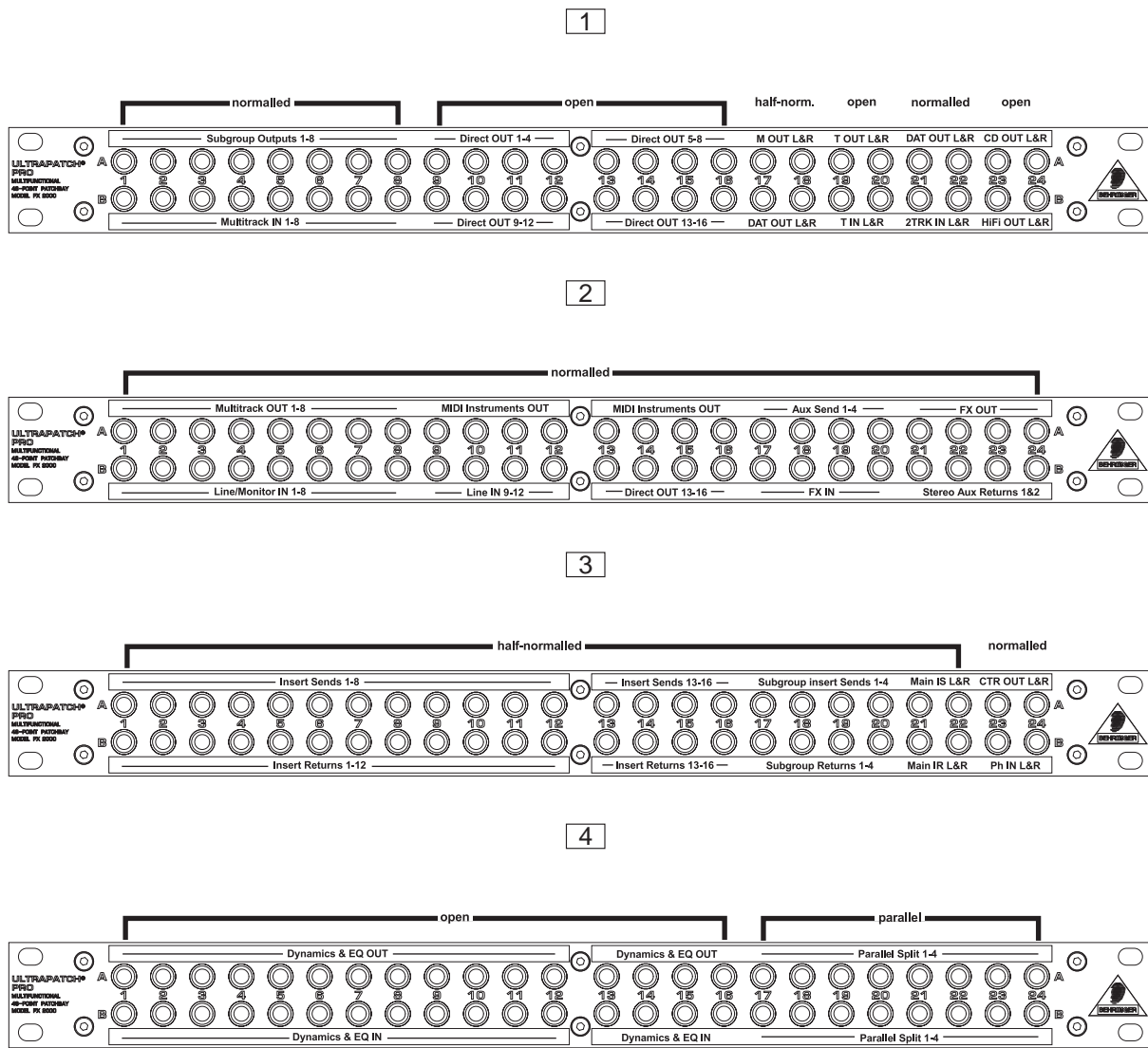

Fig. 9.5: Example of a studio organization with four patchbays

In the first eight modules of patchbay **1** the subgroup outputs are directly connected to the corresponding multitrack inputs. In addition to that it is also possible to record the signals coming from a subgroup on a different track of the multitrack. To save space and provide a clearly structured configuration, the direct outputs are connected both to the top and bottom jacks. Modules 17 & 18 are the stereo master output, which is half-normalled and thus allows for recording both to the DAT recorder and the tape deck, simply by patching it accordingly. Modules 19 & 20 (tape deck) are open, because it does not make sense connecting the inputs and outputs of the tape deck. 21 & 22 are normalled and route the DAT recorder outputs to the 2-track inputs of the mixing console. So it always is possible to control the recorded data on the 2-track from the mixing console. The CD player and the HiFi system are connected to modules 23 & 24, which are open, because they only serve as a source.

In patchbay **2** the first 16 modules are normalled (1 through 8 IN could also be used to connect the corresponding monitor inputs—if the console has a separate monitor section). MIDI devices such as samplers, expanders, keyboards, etc. are usually set up in every corner of the room. To make the cabling better structured we route these units to modules 9 through 16. This allows further workmanship of the MIDI devices at the mixing console. Modules 17 through 20 are normalled and have the FX inputs and the aux sends connected, 21 through 24 are also normalled and are patched to the two stereo aux returns with the FX outputs.

In patchbay **3**, modules 1 through 16 are for the channel insert. These modules are half-normalled, so that you have an additional route for the channel signals. The same applies to the insert paths of the subgroups and the master output. The headphones amp is connected to 23 & 24, which are normalled and connected to the control room outputs of the mixing console. Of course, you can also use pre-fader aux paths for the headphones mix.

Patchbay **4** manages the dynamics and frequency-processing devices in an open configuration (modules 1 through 16). Multigates and Compressors should be used here, in particular. Modules 17 through 24 are used to provide a “parallel split”, i.e. two modules are patched to each other on the rear with one patch cord, so that you can split up a signal applied on the front panel to several destinations. These modules have a parallel configuration.

It should be noted that patchbays should be placed one below the other in such a way that the patch cords won't hang all over the patchbays. In our example you don't have to span great distances, for instance, to patch the dynamics and EQ's to the insert paths.

9.6 Looming Problems

Loom wiring is an art unto itself, and it is worth taking time out to get it right. First off, it is important to avoid earth loops (a looped wire acts an aerial, picking up hum and electromagnetic radiation). Think of a tree. Every part of that tree is connected to every other part, but only by one route. That's how the total earth picture for your entire studio should look. Don't take the earth off your power cable plug to reduce audible 50 Hz mains hum. Rather you should be looking at disconnecting the signal screen somewhere (one or several audio cables).

It is good practice to ensure that all screens are commoned at the patchbay, in which case all unearthed equipment would pick up earth from this point via a single screen (more than one route = an earth loop), while mains-earthed equipment would have all screens cut at the equipment end.

Some quality equipment has an independent signal and mains earth. In this case at least one screen should carry earth to the equipment. Sometimes the only way to find out is “suck and see”.

Take care to ensure that using the patchbay does not disturb the studio's earth architecture. Always use short as possible patch leads with the screen connected at both ends.

Having designed mains hum out of the system, make up your cable looms from the patchbays outwards, and use cable ties, flexible sheaths, multicores, etc. to keep the back of your racks tidy.

10. APPLICATIONS

10.1 Keyboard Submixing



MIDI keyboard sub-mixing, live or in the studio, sequenced and/or played. This is relatively simple to achieve. Simply use the line inputs to mix stereo or mono outputs from your keyboards. Subgrouping may be useful *en route* to the mix, e.g. to control the level of drums versus music. Aux sends may be used either to feed on-stage monitors, artists headphones or effects units. You might want to use the stereo aux inputs for instruments with built-in EQ, since there is no EQ on these inputs. Effects could be brought back on any line input. The main L R output should feed the front-of-house or main studio console.

10.2 Live Concert with Simultaneous 8-Track Recording

Here some or all mono channels are likely to be tied up with stage mics. Carefully choose the right position so as to minimize feedback. Try to keep the stage volume as low as possible, as stage sound can cause a muddy front-of-house (FOH) sound. Don't forget to notch out troublesome frequencies using a graphic or parametric equalizer, or Feedback Destroyer (see the BEHRINGER FEEDBACK DESTROYER PRO DSP1124P and the BEHRINGER ULTRA-CURVE PRO DSP8024 which does all of these and more.)

The effects used in the FOH mix will not be recorded to multitrack. These can be added later during mixdown.

 Use the LO CUT filters **7** to eliminate floor rumble, mics popping etc.

-  Try using a compressor and noise gate on vocals, bass guitar and even drums via channel insert.
-  Effects may be a little over-the-top for a live band (not so for a dance act!). You might want to have 2 effects sends, but six independent cue feeds for on-stage monitoring.
-  Record the FOH mix to DAT (or to 1 or 2 channels of the multitrack) as a listening aid during mixdown (or to blend with dry submixes).

Channel Inputs	Source	Subgroup/Track	Mic/Line	mono/stereo
1	Vocals	1	M	m
2	Backing Vocals	2	M	m
3	Backing Vocals	2	M	m
4	Backing Vocals	2	M	m
5	Kick Drum	3&4 (Stereo Mix)	M	m
6	Snare Drum	3&4 (Stereo Mix)	M	m
7	Hi-Hat	3&4 (Stereo Mix)	M	m
8	Tom 1	3&4 (Stereo Mix)	M	m
9	Tom 2	3&4 (Stereo Mix)	M	m
10	Tom 3	3&4 (Stereo Mix)	M	m
11	Tom 4	3&4 (Stereo Mix)	M	m
12	Overhead L	3&4 (Stereo Mix)	M	m
13	Overhead R	3&4 (Stereo Mix)	M	m
14	Bass Guitar	5	M	m
15	Bass Guit. DI	5	L	m
16	Guitar	6	M	m
17	Brass 1	7	M	m
18	Brass 2	7	M	m
19	Brass 3	7	M	m
20	Brass 4	7	M	m
21	Keyboards 1	8	L	m
22	Keyboards 2	8	L	m
23	Keyboards 3	8	L	m
24	Keyboards 4	8	L	m
25/26	Effects 1	Mix (stereo)	L	s
27/28	Effects 2	Mix (stereo)	L	s
29/30	Intro Tape	Mix (stereo)	L	s
31/32	CD	Mix (stereo)	L	s
Aux Return 1	Effects 3	Mix (stereo)	L	s
Aux Return 2	Effects 4	Mix (stereo)	L	s
Aux Return 3	Effects 5	Mix (stereo)	L	s
Aux Return 4	Effects 6	Mix (stereo)	L	s
Subgroup Outputs		> Main Mix / tracks 1to 8		
Aux Output 1		> Cue 1 (pre fader) > Floor monitors 1		
Aux Output 2		> Cue 2 (pre fader) > Floor monitors 2		
Aux Output 3		> Effects 1		
Aux Output 4		> Effects 2		
Aux Output 5		> Effects 3		
Aux Output 6		> Effects 4		
Aux Output 7		> Effects 5		
Aux Output 8		> Effects 6		
Mix Output L		> Graphic EQ (Insert) > FOH		
Mix Output R		> Graphic EQ (Insert) > FOH		
Monitor Out L		> Sidefills (Main Stereo Feed)		
Monitor Out R		> Sidefills (Main Stereo Feed)		

Tab. 10.1: MX3282A tracksheet for live concert and simultaneous recording

10.3 8-Track Studio Recording

8-track MIDI project studio with sampler, 8-track recording system, one vocal mic and several effects units. With largely computer-generated dance music you will want to have plenty of line inputs, and an ability to take vocals quickly, efficiently, and with minimal desk disturbance. Often a vocal line is added after the music is almost complete. For this we try not to use a valuable aux send as a cue feed.

Once you have finished taking vocals, the subgroups may be used to submix keyboards, drums etc. into the main mix. You might want, for instance, to apply creative keyed gating to a portion of the mix. Use a subgroup insert to do this.

Auxless headphones mix

In a dance production, effects are often of paramount importance in creating interesting/evolving sounds, and aux sends are usually all dedicated to this purpose. Also it is also not unusual for a vocalist to be drafted in to add some colour to the mix at a late stage. The simplest solution here is to feed the main mix into the artist's cans. If you (or they) are uncomfortable working with the mix, try using a simple line mixer (like the BEHRINGER ULTRALINK PRO MX882) to blend the output of the mic channel (via a subgroup; possibly via a dedicated FX unit to keep the vocalist happy) with the main mix, the combined stereo signal then being fed into the vocalists cans.

If you need to hear the harmonies, but they're putting the vocalist off key, you'll want to be able to delete channels from the headphone mix. If you still don't want to assign a couple of aux buses to headphones monitoring because this would disturb the main mix, the following suggestion might prove useful: Set up a separate channel assignment on a subgroup pair, omitting the offending channels, and use that output instead of the main mix to drive the headphones either directly or via a line mixer as illustrated above.

 **In all cases the wet/dry balance of the supplementary vocal signal takes place within the FX processor.**

EURODESK MX3282A

Channel Input	Source	Subgroup/Track	Mic/Line	mono/stereo
1	Tape 1			
2	Tape 2	Mix	L	M
3	Tape 3	Mix	L	M
4	Tape 4	Mix	L	M
5	Tape 5	Mix	L	M
6	Tape 6	Mix	L	M
7	Tape 7	Mix	L	M
8	Tape 8	Mix	L	M
9	Sampler 1	Mix	L	M
10	Sampler 2	Mix	L	M
11	Sampler 3	Mix	L	M
12	Sampler 4	Mix	L	M
13	Sampler 5	Mix	L	M
14	Sampler 6	Mix	L	M
15	Sampler 7	Mix	L	M
16	Sampler 8	Mix	L	M
17	Drum Computer Kick	Mix	L	M
18	Drum Computer Snare	Mix	L	M
19	Drum Computer Hi-Hat	Mix	L	M
20	Drum Computer Clap	Mix	L	M
21	Synthesizer 1	Mix	L	M
22	Synthesizer 2	Mix	L	M
23	Synthesizer 3	Mix	L	M
24	Vocal Mic	all 8 Subgroups	M	M
25/26	Effect 1	Mix	L	S
27/28	Effect 2	Mix	L	S
29/30	Effect 3	Mix	L	S
31/32	Effect 4	Mix	L	S
Aux Return 1	Effect 5	Mix	L	S
Aux Return 2	Effect 6	Mix	L	S
Aux Return 3	Effect 7	Mix	L	S
Aux Return 4	Effect 8	Mix	L	S
Subgroup Outputs		> Main Mix/Tracks 1 to 8		
Aux Output 1	Effect 1			
Aux Output 2	Effect 2			
Aux Output 3	Effect 3			
Aux Output 4	Effect 4			
Aux Output 5	Effect 5			
Aux Output 6	Effect 6			
Aux Output 7	Effect 7			
Aux Output 8	Effect 8			
Mix Output L		> DAT		
Mix Output R		> DAT		
Monitor Out L		> CTRL-R./Headphones		
Monitor Out R		> CTRL-R./Headphones		

Tab. 10.2: 8-track studio recording

10.4 16-Track Studio Recording

This set-up is for a multipurpose studio capable of recording live bands. The following layout is for a bass & drum take while other artists also perform guides to give correct feel for the song. Mic channels are used to record to tape, eight tracks at a time (max.) via the subgroup outputs. Since there are no tape returns to monitor from tape when input channels are unavailable, you might have to temporarily patch the tape outputs into other line inputs, e.g. stereo input channels, if you want to audition a take before placing tape tracks onto their final destination desk channels. We suggest that during playback you audition in mono [39] as listening to hard-panned kick and snare drum will be irritating. If you are using analogue tape with timecode, leave track 15 free as a guard band. Place timecode on track 16.

Channel Input	Source	Subgroup/Track	Mic/Line	mono/stereo
1	Kick Drum	1	M	m
2	Snare Drum	2	M	m
3	Hi-Hat	3	M	m
4	Tom 1	4&5 (stereo mix)	M	m
5	Tom 2	4&5 (stereo mix)	M	m
6	Tom 3	4&5 (stereo mix)	M	m
7	Tom 4	4&5 (stereo mix)	M	m
8	Overheads L	6	M	m
9	Overheads R	7	M	m
10	Bass guitar	8	M	m
11	Bass guit. DI	8	L	m
12	Lead Vocal Guide	mix	M	m
13	Back Vocals Guide 1	mix	M	m
14	Back Vocals Guide 2	mix	M	m
15	Back Vocals Guide 3	mix	M	m
16	Guitar Guide	mix	M	m
17	Brass Guide 1	mix	M	m
18	Brass Guide 2	mix	M	m
19	Brass Guide 3	mix	M	m
20	Brass Guide 4	mix	M	m
21	Sequence Guide 1	mix	L	m
22	Sequence Guide 2	mix	L	m
23	Effect 1	mix	L	m
24	Effect 2	mix	L	m
25/26	Tape Monitor 1/2	mix	L	s
27/28	Tape Monitor 3/4	mix	L	s
29/30	Tape Monitor 5/6	mix	L	s
31/32	Tape Monitor 7/8	mix	L	s
AuxRtn1	Tape Monitor 9/10	mix	L	s
AuxRtn2	Tape Monitor 11/12	mix	L	s
AuxRtn3	Tape Monitor 13/14	mix	L	s
AuxRtn4	Tape Monitor 15/16	mix	L	s
Subgroup Out		> Main Mix / Tracks 1-16		
Aux Output 1		> Cue 1		
Aux Output 2		> Cue 2		
Aux Output 3		Effect 1		
Aux Output 4		Effect 2		
Aux Output 5		> Cue 3		
Aux Output 6		> Cue 4		
Aux Output 7		> Cue 5		
Aux Output 8		> Cue 6		
Mix Output L		> DAT		
Mix Output R		> DAT		
Monitor Out L		> Control Room		
Monitor Out R		> Control Room		

Tab. 10.3: MX3282A example: 16-track studio recording, bass guitar and drum tracks

Channel Input	Source	Subgroup/Track	Mic/Line	mono/stereo
1	(Kick Dr.) Tape 1	mix*	L	m
2	(Snare Dr.) Tape 2	mix*	L	m
3	(Hi-Hat) Tape 3	mix*	L	m
4	(Tom 1) Tape 4	mix*	L	m
5	(etc.) Tape 5	mix*	L	m
6	Tape 6	mix*	L	m
7	Tape 7	mix*	L	m
8	Tape 8	mix*	L	m
9	Tape 9	mix*	L	m
10	Tape 10	mix*	L	m
11	Tape 11	mix*	L	m
12	Lead Vocals Guide	mix*	M	m
13	Back Vocals Guide 1	mix*	M	m
14	Back Vocals Guide 2	mix*	M	m
15	Back Vocals Guide 3	mix*	M	m
16	Guitar Guide	1 (Track 9)	M	m
17	Brass Guide 1	2&3 (Tracks 10&11)	M	m
18	Brass Guide 2	2&3 (Tracks 10&11)	M	m
19	Brass Guide 3	2&3 (Tracks 10&11)	M	m
20	Brass Guide 4	2&3 (Tracks 10&11)	M	m
21	Sequence Guide 1	mix	L	m
22	Sequence Guide 2	mix	L	m
23	Effects 1	mix	L	m
24	Effects 2	mix	L	m
25/26	Tape Mon 1/2	mix	L	s
27/28	Tape Mon 3/4	mix	L	s
29/30	Tape Mon 5/6	mix	L	s
31/32	Tape Mon 7/8	mix	L	s
AuxRtn1	Tape Monitor 9/10	mix	L	s
AuxRtn2	Tape Monitor 11/12	mix	L	s
AuxRtn3	Tape Monitor 13/14	mix	L	s
AuxRtn4	Tape Monitor 15/16	mix	L	s
Outputs remain unchanged (temporary)				

Tab. 10.4: MX3282A example: 16-track studio recording “overdubs”

The layout shown in fig. 10.4 corresponds to the music overdub situation once all bass & drum takes have been completed. We have re-patched tape tracks onto main channels.

Remember to disconnect (from the wall boxes or desk XLR inputs) any microphones not in use. Otherwise the line inputs of channels 1-24 won't work properly (live mics picking up extraneous noise etc.).

*: The temporary tape monitor returns become redundant as and when tape tracks are able to be patched into main channels. You could begin to spread your FX and sequenced music returns over these stereo channels as they become available.

At last it is time for vocal overdubs and touch-ups like percussion parts.

(Fig. 10.4): Once overdubbing is complete the subgroups may be used in mono (or stereo pairs) as an aid to mixdown, e.g. to control multiple backing vocals, or drum kit tracks such as tom-toms and overhead mics.

10.5 Multitrack Initialization

Set up the multitrack so that any track in “record ready” condition has it's input monitored when the tape is stationary. Place all tracks to be recorded into “record ready” status (once a recording has been made, these tracks should automatically switch to tape playback).

Check that the input levels to each track are optimized before recording commences.

10.6 Recording Levels

When recording to digital, it's a good idea to keep the recorder's peak meters below 0 dB. Most (not all, esp. samplers) read 0 dB with some headroom left. This is because, unlike with analog, the onset of digital distortion is as sudden as it is horrible. If you really want to take your recording level to the limit (and fully exploit 16-bit digital's 96 dB dynamic range), you'll have to do some calibrating. How to do it? Well, you could run a tone at 0 dB from the mixer and use that as your DAT reference. But your DAT may be way under its maximum input limit. Probably a better way to work out just how hard you can drive your recorder is to incrementally increase the record level until the onset of digital distortion, subtract, say, 5 or 10 dB, and never exceed that level. Engage "peak hold" on your recorder before recording if you want to confirm that you haven't.

When recording to analog, the tape machine's VU meters should show around +3 dB on bass, but only around -10 dB for hi hat. Although analog distortion is more like compression at modest overload levels (often desirable on bottom end), higher frequencies cause saturation even at modest levels (an unpleasant "crunchiness"). Also, VU meters tend to progressively under-read above 1 kHz, due to their sluggish response time. Hi-hats should read about -10 dB on a VU meter, as against 0 dB for a typical snare drum, and +3 dB or more for a kick drum.

Peak meters read more-or-less independent of frequency. Aim for 0 dB recording level for all signals.

10.7 Track Sheet

When laying out channels for recording or mixing, try to be sensible. Keep tom-toms together, etc. Work out a scheme that suits you & stick to it. A common order is: kick drum, snare, hi-hat, tom-toms (as the audience sees the kit), cymbals (dito), bass, guitars, keyboards, other instruments, vocals. From session to session and gig to gig you will soon know where you are without ever having to look at a track sheet.

11. TECHNICAL BACKGROUND

11.1 Mixing

11.1.1 Equalization

In the beginning, EQ was an instrument for removing unwanted frequencies, or compensating for imperfect microphone response curves, or bumps in a studio's acoustic. It was a corrective device. Tamla Motown turned that notion upside down in the sixties with the novel idea that you try to find for each instrument a characteristic frequency not shared by the other instruments in the mix. Then you whack up its gain. This makes individual voices punch through a mix in a slightly unnatural but exciting way.

In general, corrective EQ usually involves broadband (slope) contouring, together with narrowband notching of unwanted resonances. The narrower the notch or "Q", the less the total signal will be affected.

Finding bad resonances is made easier by first frequency sweeping in BOOST mode.

"Motown" EQ is achieved by applying boost in a fairly broadband way. The broader the band, the more musical but less instrument-specific the effect. Applying boost over a narrow bandwidth will sound "honky". For sounds which require drastic corrective EQ, it is advisable to have a couple of channels of fully comprehensive parametric equalization in your rack. (You can always bounce tracks through the outboard EQ, freeing up the unit for the next task).

Check out the BEHRINGER ULTRA-CURVE PRO DSP8024, a superlative digital stereo equalizer and much, much more. Or our ULTRA-Q PRO PEQ2200 5-band constant-Q state-variable analog EQ.

For "advanced equalization", EQ might be applied to a signal as follows: First, trim the LF and HF shelves to achieve the required slope or "loudness". Now use a parametric EQ band to boost the most significant frequency for each instrument or tape track. Over all channels, if two or more of these frequencies coincide, then you might have to settle for second best in some cases, if you want to achieve optimum separation in the mix. Really nasty frequencies will need notching out.

A vocal signal can be enhanced by applying a significant boost in the 12 kHz region or higher, above the nasty sibilance region. This is especially effective if you've got a de-esser patched post-EQ.

 **Use the low-cut filter to tighten up channels in a mix: maybe remove it only for the bass, kick drum, toms, tablas, didgeridoo and other deliberate subsonics (when recording classical music ignore this advice).**

With the LF set to boost and the low-cut switch activated, you have got a peak response rather than shelving at the bottom. Good for tight but deep bass.

Remember EQ contouring can be done with cut as well as with boost. Cutting away the top and bottom, then pushing up the gain is equivalent to mid range boost! EQ is not a one way street!

Always reset a channel's input gain (or external devices' output level) after altering the amount of desk EQ cut or boost applied.

11.1.2 Gain Optimization

PFL (Pre-Fader-Listen) is the way to set a desk level. Master aux send levels are fixed at unity gain. As the mix progresses, more and more channels are likely to be sending to effects via the aux buses, and it's best to PFL all sends just before setting up for the final mix.

Outboard reverbs etc. should all be made to work hard. There's no point in having an 85 dB dynamic range if the input meter of your reverb is barely flickering. On the other hand, digital distortion is not one of the nicer noises around. You'll have to rely on your ears to detect digital distortion, since different outboard processors calibrate their meters differently.

If you hear distortion, turn down the input on the FX unit, and turn up the desk's aux return input.

99 times out of 100 distortion in the aux send > FX > aux return loop will come from the FX unit (FX gain too high), and the same goes for a high noise level (FX gain too low).

Analog multitrack tape should be driven quite hard, since its dynamic range (without noise reduction) is likely to be 20 to 30 dB worse than other elements in the recording chain. Try to record bright. You can always mix back duller. Brightening up an off-tape signal will bring up the level of tape noise. With digital tape or hard disk you have plenty of dynamic range, and treble pre-emphasis is not often necessary. Just don't let the signal distort!

When mixing or recording, keep the channel fader levels around or below 0 dB. If you do find the faders creeping up or down, apply a suitable offset over all channel faders, and try to control your bad habit in future!

12. EXPANDING

When the EURODESK is your main mixer, you may find that you run out of inputs as your system expands. It is possible to expand your mixing system by combining two or more mixers.

Adding extra line inputs to your EURODESK

A small line mixer (such as the BEHRINGER ULTRALINK PRO MX882 8+2 Channel Mixer/Splitter/Signal Router) can inexpensively add extra line inputs to your console. With the ULTRALINK PRO, any stereo,

line-level input on your EURODESK can become a stereo line input plus a further 6 pan-able mono line inputs. Great for adding tape monitor returns etc.

The EURODESK outputs are essentially submixes of several channels of sound, and are therefore likely to be considerably higher than the typical source signals (coming from mics, MIDI instruments or tape) seen by the master console. Therefore, we recommend a reduction of gain in those channels of the master console that are fed by the EURODESK's outputs.

Linking the EURODESK to a master console

Feed any or all of the main mix, subgroup outputs and aux outputs from your EURODESK into separate input channels of the master console. The aux outputs should be routed only to individual aux send buses on the master console. Now the aux sends from the EURODESK can access effects currently used by the master console.

13. MODIFICATIONS

The following modifications require you to do some soldering. Only attempt that if you are experienced in using an iron on PCBs. Otherwise, refer to qualified personnel. After modification the BEHRINGER warranty becomes discretionary.

Links should not be threaded into holes on the PCB. They should be soldered to the tinned areas around the holes, and bowed slightly upwards in between.

Aux sends > pre EQ

All channel aux sends are post-EQ. If you want to convert them, carry out the modification described below to each channel. The right PCB area is indicated by a yellow printing (see figures below).

- 1) Disconnect power supply.
- 2) Cut the 'post' track.
- 3) Add in a 'pre' link.
- 4) Repeat for all channels you want to be modified.

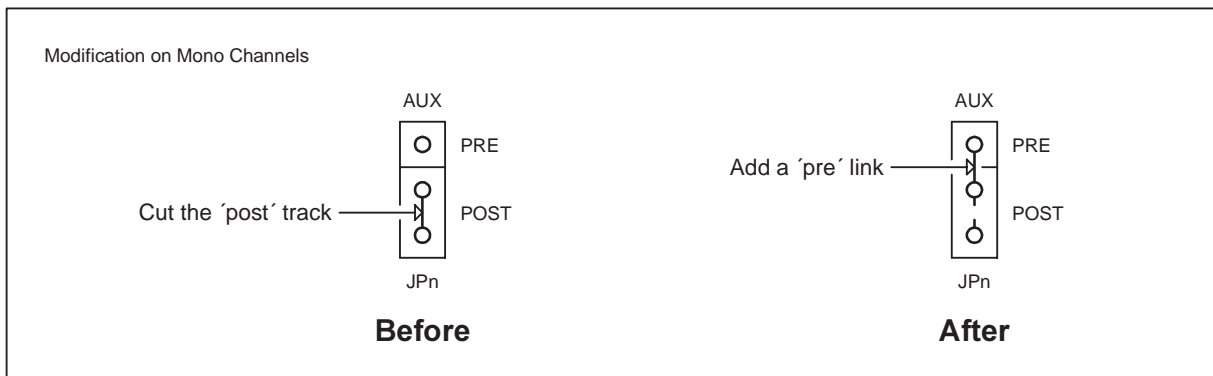

Fig. 13.1: Aux send > pre-EQ-modification on channels 1 to 24

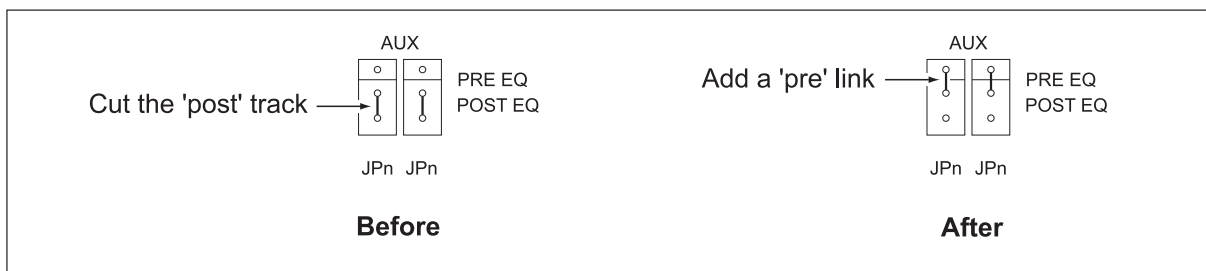

Fig. 13.2: Aux send > pre-EQ-modification on channels 25/26 to 31/32

14. SPECIFICATIONS

Input channels

Mic input	Electronically balanced, discrete input configuration
Mic E.I.N. (22 Hz - 22 kHz)	129.0 dBu, 150 Ohm source 117.3 dBqp, 150 Ohm source 132.0 dBu, input shorted 122.0 dBqp, input shorted
Distortion (THD&N)	0,007% @ +4 dBu, 1 kHz, bandwidth 80 kHz
Gain range	+10 dB to +60 dB
Max input (Mic)	+12 dBu
Line input	Electronically balanced
gain range	Unity to +40 dB
Max input (line)	+22 dBu
Channel fader range	+10 dB to -85 dB
Aux send gain range	off to Unity to +15 dB

Equalization

Hi shelving	12 kHz +/-15 dB, Q fixed at 2 oct.
Hi mid bell (Ch 25-32)	3 kHz +/-15 dB, Q fixed at 2 oct.
Mid sweep (Ch 1-24)	100 Hz - 8 kHz +/-15 dB, Q fixed at 1 oct.
Lo mid bell (Ch 25-32)	500 Hz +/-15 dB, Q fixed at 2 oct.
Lo shelving	80 Hz +/-15 dB, Q fixed at 2 oct.
Low-cut (high pass) filter	75 Hz, 18 dB/oct.

Channel insert

Max in / out	+22 dBu
Channel to channel crosstalk	-95 dB @ 1 kHz

Subgroup section

Noise	Bus noise @ fader 0 dB: -105.0 dBr (ref.: +4 dBu); -92.0 dBr (ref.: +4 dBu, all input channels assigned, Unity gain, channels muted); -87.0 dBr (ref.: +4 dBu, all input channels assigned, Unity gain)
-------	--

Submaster output

Max. output	+22 dBu balanced/unbalanced
Fader range	+10 dB to -85 dB/off

Main mix section

Noise	Bus noise @ fader 0 dB: -102.0 dBr (ref.: +4 dBu); -92.0 dBr (ref.: +4 dBu, all input channels assigned, Unity gain, channels muted); -87.0 dBr (ref. +4 dBu, all input channels assigned, Unity gain)
Max output	+28 dBu balanced, +22 dBu unbalanced

Aux returns

Gain range	off to Unity to +20 dB
------------	------------------------

Aux sends

Max. output	+22 dBu
-------------	---------

General

Distortion (THD & N)	0.007 %, @ +4 dBu, 1 kHz, bandwidth 80 kHz
Frequency response	20 Hz - 40 kHz +/-1 dB any input to any output; 10 Hz -120 kHz +/-3 dB

Physical dimensions

(H * W * D) Mixer	approx. 3 3/4" (90 mm) * 40" (1015 mm) * 20 3/4" (527 mm)
Weight	approx. 17,7 kg
(H * W * D) Power Supply Unit	approx. 3 1/2" (86 mm) * 17 1/8" (435 mm) * 9 3/4" (246 mm)
Weight	6,2 kg

BEHRINGER is constantly striving to maintain the highest professional standards. As a result of these efforts, modifications may be made from time to time to existing products without prior notice. Specifications and appearance may differ from those listed or shown.

15. WARRANTY

§ 1 WARRANTY CARD/ONLINE REGISTRATION

To be protected by the extended warranty, the buyer must complete and return the enclosed warranty card within 14 days of the date of purchase to BEHRINGER Spezielle Studiotechnik GmbH, in accordance with the conditions stipulated in § 3. Failure to return the card in due time (date as per postmark) will void any extended warranty claims.

Based on the conditions herein, the buyer may also choose to use the online registration option via the Internet (www.behringer.com or www.behringer.de).

§ 2 WARRANTY

1. BEHRINGER (BEHRINGER Spezielle Studiotechnik GmbH including all BEHRINGER subsidiaries listed on the enclosed page, except BEHRINGER Japan) warrants the mechanical and electronic components of this product to be free of defects in material and workmanship for a period of one (1) year from the original date of purchase, in accordance with the warranty regulations described below. If the product shows any defects within the specified warranty period that are not due to normal wear and tear and/or improper handling by the user, BEHRINGER shall, at its sole discretion, either repair or replace the product.

2. If the warranty claim proves to be justified, the product will be returned to the user freight prepaid.

3. Warranty claims other than those indicated above are expressly excluded.

§ 3 RETURN AUTHORIZATION NUMBER

1. To obtain warranty service, the buyer (or his authorized dealer) must call BEHRINGER (see enclosed list) during normal business hours **BEFORE** returning the product. All inquiries must be accompanied by a description of the problem. BEHRINGER will then issue a return authorization number.

2. Subsequently, the product must be returned in its original shipping carton, together with the return authorization number to the address indicated by BEHRINGER.

3. Shipments without freight prepaid will not be accepted.

§ 4 WARRANTY REGULATIONS

1. Warranty services will be furnished only if the product is accompanied by a copy of the original retail dealer's invoice. Any product deemed eligible for repair or replacement by BEHRINGER under the terms of this warranty will be repaired or replaced within 30 days of receipt of the product at BEHRINGER.

2. If the product needs to be modified or adapted in order to comply with applicable technical or safety standards on a national or local level, in any country which is not the country for which the product was originally developed and manufactured, this modification/adaptation shall not be considered a defect in materials or workmanship. The warranty does not cover any such modification/adaptation, irrespective of whether it was carried out properly or not. Under the terms of this warranty, BEHRINGER shall not be held responsible for any cost resulting from such a modification/adaptation.

3. Free inspections and maintenance/repair work are expressly excluded from this warranty, in particular, if caused by improper handling of the product by the user.

This also applies to defects caused by normal wear and tear, in particular, of faders, potentiometers, keys/buttons and similar parts.

4. Damages/defects caused by the following conditions are not covered by this warranty:

- ▲ misuse, neglect or failure to operate the unit in compliance with the instructions given in BEHRINGER user or service manuals.
- ▲ connection or operation of the unit in any way that does not comply with the technical or safety regulations applicable in the country where the product is used.
- ▲ damages/defects caused by force majeure or any other condition that is beyond the control of BEHRINGER.

5. Any repair or opening of the unit carried out by unauthorized personnel (user included) will void the warranty.

6. If an inspection of the product by BEHRINGER shows that the defect in question is not covered by the warranty, the inspection costs are payable by the customer.

7. Products which do not meet the terms of this warranty will be repaired exclusively at the buyer's expense. BEHRINGER will inform the buyer of any such circumstance. If the buyer fails to submit a written repair order within 6 weeks after notification, BEHRINGER will return the unit C.O.D. with a separate invoice for freight and packing. Such costs will also be invoiced separately when the buyer has sent in a written repair order.

§ 5 WARRANTY TRANSFERABILITY

This warranty is extended exclusively to the original buyer (customer of retail dealer) and is not transferable to anyone who may subsequently purchase this product. No other person (retail dealer, etc.) shall be entitled to give any warranty promise on behalf of BEHRINGER.

§ 6 CLAIM FOR DAMAGES

Failure of BEHRINGER to provide proper warranty service shall not entitle the buyer to claim (consequential) damages. In no event shall the liability of BEHRINGER exceed the invoiced value of the product.

§ 7 OTHER WARRANTY RIGHTS AND NATIONAL LAW

1. This warranty does not exclude or limit the buyer's statutory rights provided by national law, in particular, any such rights against the seller that arise from a legally effective purchase contract.

2. The warranty regulations mentioned herein are applicable unless they constitute an infringement of national warranty law.

The information contained in this manual is subject to change without notice. No part of this manual may be reproduced or transmitted in any form or by any means, electronic or mechanical, including photocopying and recording of any kind, for any purpose, without the expressed written permission of BEHRINGER Spezielle Studiotechnik GmbH.

BEHRINGER, EURORACK, EURODESK, ULTRA-DYNE, ULTRA-CURVE, ULTRA-Q, ULTRAPATCH, POWERPLAY and FEEDBACK DESTROYER are registered trademarks. ALL RIGHTS RESERVED.

© 2001 BEHRINGER Spezielle Studiotechnik GmbH.

BEHRINGER Spezielle Studiotechnik GmbH, Hanns-Martin-Schleyer-Str. 36-38, 47877 Willich-Müncheheide II, Germany
Tel. +49 (0) 21 54 / 92 06-0, Fax +49 (0) 21 54 / 92 06-30