

Grizzly *Industrial, Inc.*®

EDGE SANDER MODEL G0512 INSTRUCTION MANUAL



COPYRIGHT © MAY, 2003 BY GRIZZLY INDUSTRIAL, INC.

**WARNING: NO PORTION OF THIS MANUAL MAY BE REPRODUCED IN ANY SHAPE
OR FORM WITHOUT THE WRITTEN APPROVAL OF GRIZZLY INDUSTRIAL, INC.**

#528603624 PRINTED IN TAIWAN

ONLINE MANUAL DISCLAIMER

THE INFORMATION IN THIS MANUAL REPRESENTS THE CONFIGURATION OF THE MACHINE AS IT IS CURRENTLY BEING SHIPPED. THE MACHINE CONFIGURATION CAN CHANGE AS PRODUCT IMPROVEMENTS ARE INCORPORATED. IF YOU OWN AN EARLIER VERSION OF THE MACHINE, THIS MANUAL MAY NOT EXACTLY DEPICT YOUR MACHINE. CONTACT CUSTOMER SERVICE IF YOU HAVE ANY QUESTIONS ABOUT DIFFERENCES. PREVIOUS VERSIONS ARE NOT AVAILABLE ONLINE.

WARNING

Some dust created by power sanding, sawing, grinding, drilling, and other construction activities contains chemicals known to the State of California to cause cancer, birth defects or other reproductive harm. Some examples of these chemicals are:

- Lead from lead-based paints.
- Crystalline silica from bricks, cement, and other masonry products.
- Arsenic and chromium from chemically treated lumber.

Your risk from these exposures varies, depending on how often you do this type of work. To reduce your exposure to these chemicals: work in a well ventilated area, and work with approved safety equipment, such as those dust masks that are specially designed to filter out microscopic particles.

TABLE OF CONTENTS

SECTION 1: SAFETY	2
Safety Instructions For Power Tools	2
Additional Safety Instructions For Sanders	4
SECTION 2: INTRODUCTION	5
SECTION 3: CIRCUIT REQUIREMENTS	6
Grounding.....	7
Extension Cords	7
SECTION 4: IDENTIFICATION	8
SECTION 5: SET UP	9
Unpacking	9
G0512 Inventory.....	9
Hardware Recognition Chart	10
Clean Up	11
Site Considerations	11
Beginning Assembly.....	12
Installing Feet.....	12
Installing Tension Lever	13
Installing Sanding Belt	13
Attaching Dust Port	14
Installing Roller Guard	15
Test Run & Tracking	15
Installing Table	16
Installing Back Stop	18
Connecting to Dust Collection System.....	18
SECTION 6: OPERATIONS	19
Power Switch	19
Adjusting Table Height.....	20
Sanding Belt Selection	20
Edge & End Sanding	21
Contour Sanding	22
SECTION 7: MAINTENANCE	23
General.....	23
Table	23
Lubrication	23
Sanding Belt.....	23
SECTION 8: SERVICE ADJUSTMENTS	24
About Service.....	24
Adjusting Tensioner	24
Resetting Tensioner Spring Tension	25
Parallel Belt Tracking	26
Platen-to-Rollers Adjustments	28
SECTION 9: REFERENCE INFO	31
Aftermarket Accessories	31
Machine Data Sheet.....	32
Parts Breakdown and List	33
Troubleshooting Machine.....	35
Troubleshooting Sanding	36
G0512 Wiring Diagram.....	37
Warranty and Returns	38

SECTION 1: SAFETY

WARNING

For Your Own Safety Read Instruction Manual Before Operating This Equipment

The purpose of safety symbols is to attract your attention to possible hazardous conditions. This manual uses a series of symbols and signal words which are intended to convey the level of importance of the safety messages. The progression of symbols is described below. Remember that safety messages by themselves do not eliminate danger and are not a substitute for proper accident prevention measures.



Indicates an imminently hazardous situation which, if not avoided, WILL result in death or serious injury.



Indicates a potentially hazardous situation which, if not avoided, COULD result in death or serious injury.



Indicates a potentially hazardous situation which, if not avoided, MAY result in minor or moderate injury. It may also be used to alert against unsafe practices.

NOTICE

This symbol is used to alert the user to useful information about proper operation of the equipment.

WARNING

Safety Instructions For Power Tools

1. **KEEP GUARDS IN PLACE** and in working order.
2. **REMOVE ADJUSTING KEYS AND WRENCHES.** Form habit of checking to see that keys and adjusting wrenches are removed from tool before turning on.
3. **KEEP WORK AREA CLEAN.** Cluttered areas and benches invite accidents.
4. **NEVER USE IN DANGEROUS ENVIRONMENT.** DO NOT use power tools in damp or wet locations, or where any flammable or noxious fumes may exist. Keep work area well lighted.
5. **KEEP CHILDREN AND VISITORS AWAY.** All children and visitors should be kept at a safe distance from work area.
6. **MAKE WORKSHOP CHILD PROOF** with padlocks, master switches, or by removing starter keys.
7. **NEVER FORCE TOOL.** It will do the job better and safer at the rate for which it was designed.
8. **USE RIGHT TOOL.** DO NOT force tool or attachment to do a job for which it was not designed.

WARNING

Safety Instructions For Power Tools

- 9. USE PROPER EXTENSION CORD.** Make sure your extension cord is in good condition. Conductor size should be in accordance with the chart below. The amperage rating should be listed on the motor or tool nameplate. An undersized cord will cause a drop in line voltage resulting in loss of power and overheating. Your extension cord must also contain a ground wire and plug pin. Always repair or replace extension cords if they become damaged.

Minimum Gauge for Extension Cords

AMP RATING	LENGTH		
	25ft	50ft	100ft
0-6	16	16	16
7-10	16	16	14
11-12	16	16	14
13-16	14	12	12
17-20	12	12	10
21-30	10	10	No

- 10. WEAR PROPER APPAREL.** DO NOT wear loose clothing, gloves, neckties, rings, bracelets, or other jewelry which may get caught in moving parts. Non-slip footwear is recommended. Wear protective hair covering to contain long hair.
- 11. ALWAYS USE SAFETY GLASSES.** Also use face or dust mask if cutting operation is dusty. Everyday eyeglasses only have impact resistant lenses, they are NOT safety glasses.
- 12. SECURE WORK.** Use clamps or a vise to hold work when practical. It is safer than using your hand and frees both hands to operate tool.
- 13. DO NOT OVER-REACH.** Keep proper footing and balance at all times.
- 14. MAINTAIN TOOLS WITH CARE.** Keep tools sharp and clean for best and safest performance. Follow instructions for lubricating and changing accessories.

- 15. USE RECOMMENDED ACCESSORIES.** Consult the owner's manual for recommended accessories. The use of improper accessories may cause risk of injury.

- 16. REDUCE THE RISK OF UNINTENTIONAL STARTING.** On machines with magnetic contact starting switches there is a risk of starting if the machine is bumped or jarred. Always disconnect from power source before adjusting or servicing. Make sure switch is in OFF position before reconnecting.

- 17. CHECK DAMAGED PARTS.** Before further use of the tool, a guard or other part that is damaged should be carefully checked to determine that it will operate properly and perform its intended function. Check for alignment of moving parts, binding of moving parts, breakage of parts, mounting, and any other conditions that may affect its operation. A guard or other part that is damaged should be properly repaired or replaced.

- 18. NEVER LEAVE TOOL RUNNING UNATTENDED. TURN POWER OFF.** DO NOT leave tool until it comes to a complete stop.

- 19. NEVER OPERATE A MACHINE WHEN TIRED, OR UNDER THE INFLUENCE OF DRUGS OR ALCOHOL.** Full mental alertness is required at all times when running a machine.

- 20. NEVER ALLOW UNSUPERVISED OR UNTRAINED PERSONNEL TO OPERATE THE MACHINE.** Make sure any instructions you give in regards to machine operation are approved, correct, safe, and clearly understood.

- 21. IF AT ANY TIME YOU ARE EXPERIENCING DIFFICULTIES** performing the intended operation, stop using the machine! Then contact our service department or ask a qualified expert how the operation should be performed.

WARNING

Additional Safety Instructions For Sanders

- **DO NOT** allow anyone to stand near the sander while sanding wood stock.
- **DO NOT** jam the workpiece against the sanding belt. Firmly grasp the workpiece in both hands and ease it against the sanding belt, using light pressure.
- **DO NOT** wear loose clothing while operating this machine. Roll up or button sleeves at the cuff.
- **DO NOT** place hands near, or in contact with, sanding belt during operation.
- **ANY PROBLEM**, with the exception of belt tracking, that is concerned at all with any moving parts or accessories must be investigated and corrected with the power disconnected, and after everything has come to a complete stop.
- **PERFORM** machine inspections and maintenance service promptly when called for.
- **NEVER** leave the machine running unattended.
- **REPLACE** sanding belt when it becomes worn.
- **NEVER** sand more than one piece of stock at a time.
- **ALWAYS** inspect board stock for nails, staples, knots, and other imperfections that could be dislodged and thrown from the machine during sanding operations.
- **NEVER** operate the sander without an adequate dust collection system in place and running.
- **NEVER** sand tapered or pointed stock with the point facing the feed direction.
- **ALWAYS** wear a dust mask when sanding. Using this machine produces sawdust which may cause allergic reactions or respiratory problems.

CAUTION

No list of safety guidelines can be complete. Every shop environment is different. Always consider safety first, as it applies to your individual working conditions. Use this and other machinery with caution and respect. Failure to do so could result in serious personal injury, damage to equipment or poor work results.

WARNING

Like all power tools, there is danger associated with the Edge Sander. Accidents are frequently caused by lack of familiarity or failure to pay attention. Use this tool with respect and caution to lessen the possibility of operator injury. If normal safety precautions are overlooked or ignored, serious personal injury may occur.

SECTION 2: INTRODUCTION

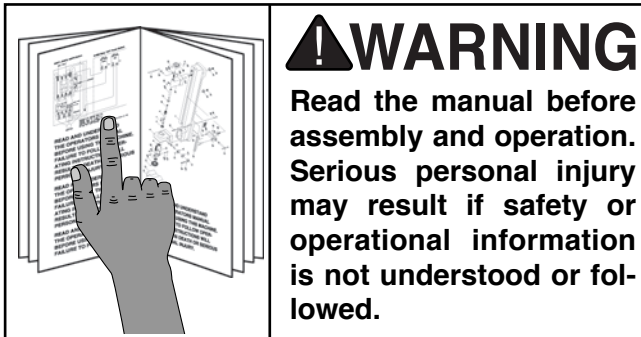

If you have any comments regarding this manual, please write to us at the address below:

Grizzly Industrial, Inc.
c/o Technical Documentation
P.O. Box 2069
Bellingham, WA 98227-2069

Most importantly, we stand behind our machines. If you have any service questions or parts requests, please call or write us at the location listed below.

We are proud to offer the Model G0512 Edge Sander. This Edge Sander is part of a growing Grizzly family of fine woodworking machinery. When used according to the guidelines set forth in this manual, you can expect years of trouble-free, enjoyable operation and proof of Grizzly's commitment to customer satisfaction.

This sander was developed for those projects that require a large support area and need the workpiece to be moved around the roller. The specially designed small 2½" edge diameter roller allows you to get into tighter radius projects like guitar bodies, curved chair legs etc.... The table is supported in four positions to eliminate sagging and to provide a stable base while working, and the quick belt release mechanism makes it easy to change belts fast.

We are pleased to provide this manual with the Model G0512. It was written to guide you through assembly, to review safety considerations, and to cover general operating procedures. It represents our effort to produce the best documentation possible.

Grizzly Industrial, Inc.
1203 Lycoming Mall Circle
Muncy, PA 17756
Phone: (570) 546-9663
Fax: (800) 438-5901
E-Mail: techsupport@grizzly.com
Web Site: <http://www.grizzly.com>

The specifications, drawings, and photographs illustrated in this manual represent the Model G0512 as supplied when the manual was prepared. However, owing to Grizzly's policy of continuous improvement, changes may be made at any time with no obligation on the part of Grizzly. For your convenience, we always keep current Grizzly manuals available on our website at www.grizzly.com. Any updates to your machine will be reflected in these manuals as soon as they are complete. Visit our site often to check for the latest updates to this manual!

SECTION 3: CIRCUIT REQUIREMENTS

Amperage Draw

The Model G0512 features a 110V/220V motor that is prewired at 220V.

Motor Load at 220V	10 amps
Motor Load at 110V	20 amps

Plug Type

The cord set enclosed does not have a plug as the style of plug you require will depend upon the type of service you currently have or plan to install. We recommend using the following plugs for your machine on a dedicated circuit only (see **Figures 1 & 2** for an example):

220V Plug & Receptacle	6-15
110V Plug & Receptacle	5-20

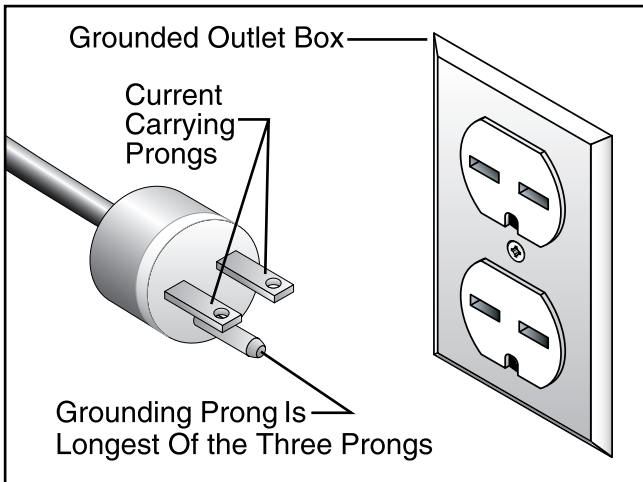

Figure 1. 6-15 plug and receptacle.

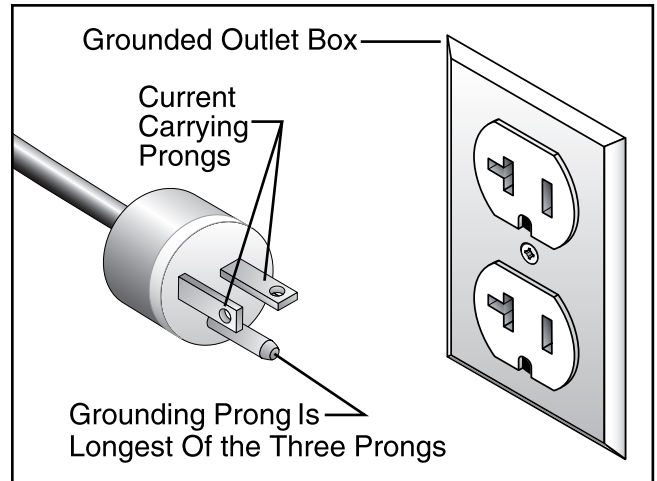

Figure 2. 5-20 plug and outlet.

Circuit Breaker Requirements

Please use the following guidelines when choosing a circuit breaker for your machine (circuit breakers rated any higher are not adequate to protect the circuit):

220V Circuit Breaker	10 amp
110V Circuit Breaker	20 amp

Your Circuit Capacity

Always check to see if the wires in your circuit are capable of handling the amperage load from your machine. If you are unsure, consult a qualified electrician. If you operate your sander on any circuit that is already close to its capacity, it might blow a fuse or trip a circuit breaker. However, if an unusual load does not exist and a power failure still occurs, contact a qualified electrician or our Service Department.

NOTICE

The Model G0512 is prewired for 220V operation. If you plan to rewire your machine for 110V, you must use a different switch. Consult a licensed electrician before attempting to rewire your machine!

WARNING

DO NOT connect your machine to the power source until you have completed the assembly process and have been instructed to do so in this manual. Otherwise, serious personal injury could occur.



Grounding

In the event of an electrical short, grounding reduces the risk of electric shock by providing a path of least resistance to disperse electric current. This tool is equipped with a power cord that has a plug with an equipment-grounding prong. The outlet must be properly installed and grounded in accordance with all local codes and ordinances.

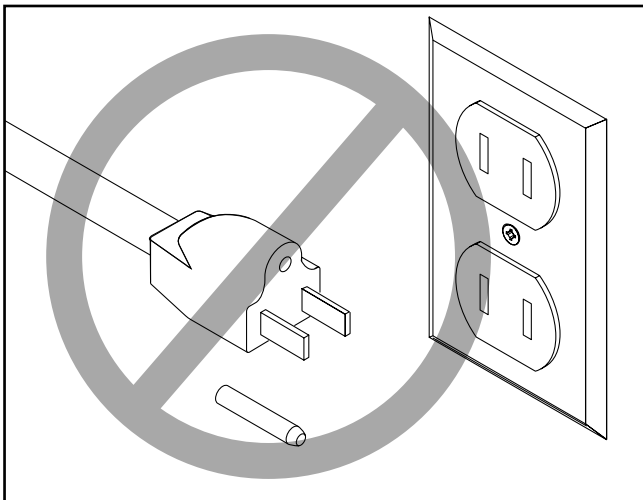
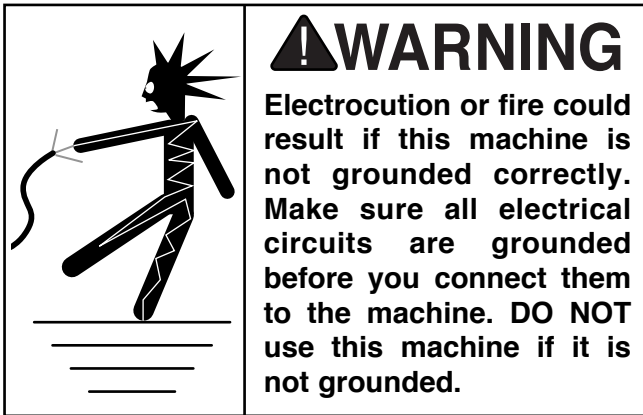

⚠ CAUTION
This machine must have a ground prong in the plug to help ensure that it is grounded. **DO NOT** remove ground prong from plug to fit into a two-pronged outlet! If the plug will not fit the outlet, have the proper outlet installed by a qualified electrician.



Extension Cords

220V Operation

We do not recommend the use of extension cords on 220V equipment. Instead, arrange the placement of your equipment and the installed wiring to eliminate the need for extension cords.

If you find it absolutely necessary to use an extension cord at 220V with your Grizzly Edge Sander:

- Make sure the cord is rated for Standard Service (grade S) or better.
- The extension cord must also contain a ground wire and plug prong.
- Use at least a 16 gauge cord if the cord is 50 feet long or less.
- Use at least a 14 gauge cord if the cord is between 51-100 feet.

110V Operation

If you find it necessary to use an extension cord at 110V with your Grizzly Edge Sander:

- Make sure the cord is rated Standard Service (grade S) or better.
- The extension cord must also contain a ground wire and plug pin.
- Use at least a 10 gauge cord if the cord is 50 feet long or less.
- **DO NOT** use a cord longer than 50 feet!



SECTION 4: IDENTIFICATION

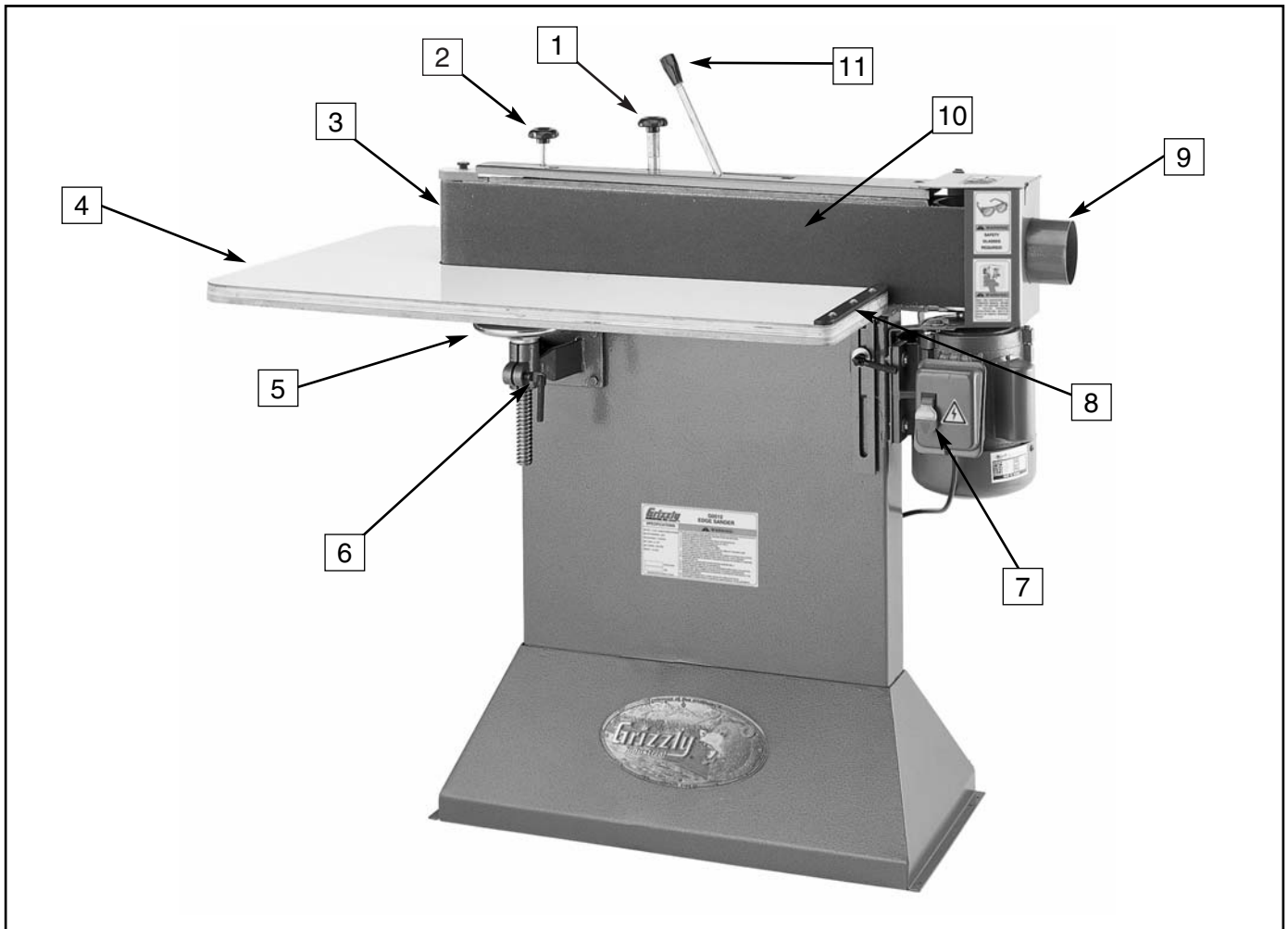

Figure 3. The following is a list of controls and components on the Model G0512. Please take time to become familiar with each item and its location. These items will be used throughout the manual and knowing them is essential to understanding the instructions and terminology used in this manual.

- | | |
|------------------------------|------------------------|
| 1. Belt Tracking Knob | 7. ON/OFF Switch |
| 2. Tracking Lock | 8. Back Stop |
| 3. Contour Sanding Area | 9. Dust Port |
| 4. Sanding Table | 10. Flat Sanding Area |
| 5. Table Elevation Handwheel | 11. Belt Tension Lever |
| 6. Lead Screw Lock Handle | |

SECTION 5: SET UP

Unpacking

The Model G0512 was carefully packed when it left our warehouse. If you discover the machine is damaged after you have signed for delivery, *please immediately call Customer Service at (570) 546-9663 for advice.*

Save the containers and all packing materials for possible inspection by the carrier or its agent. *Otherwise, filing a freight claim can be difficult.*

When you are completely satisfied with the condition of your shipment, you should inventory the contents.

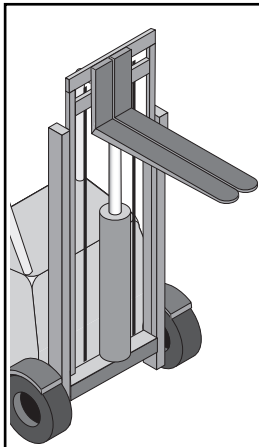

⚠️ WARNING

The Edge Sander is a heavy machine at approx. 250 lbs. shipping weight. **DO NOT** move the machine by yourself – you will need assistance or power equipment. Serious personal injury may occur if safe moving methods are not followed.

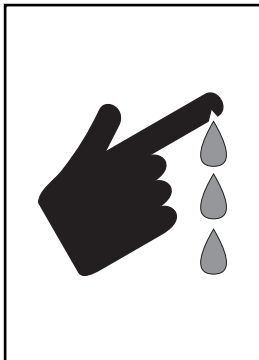

⚠️ CAUTION

Some metal parts may have sharp edges on them after they are formed. Please examine the edges of all metal parts before handling them. Failure to do so could result in injury.



G0512 Inventory

- G0512 Sander Unit1
- Wood Table1
- Dust Port1
- Lead Screw Bracket Assembly1
- L Support2
- Front L Support Assembly1
- Back Stop.....1
- Lever Handle1
- 6" x 80" Sanding Belt1
- Idler Roller Cover1
- Small Star Knob1
- Hardware Bag1
- Lock Handle3
- Flat Washer ³/₈"6
- Plastic Feet.....4
- Phillips Head Screw #10-24 x ⁵/₈"4
- Phillips Head Tap Screws #8 x ³/₄"19

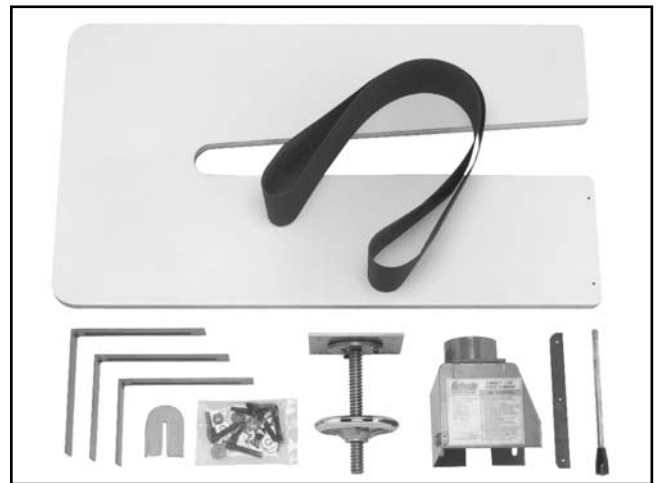







Figure 4. Model G0512 packaging inventory.



Hardware Recognition Chart

USE THIS CHART TO MATCH UP HARDWARE DURING THE ASSEMBLY PROCESS!

MEASURE BOLT DIAMETER BY PLACING INSIDE CIRCLE

-  #10
-  1/4"
-  5/16"
-  3/8"
-  7/16"
-  1/2"

-  5/8"

-  4mm

-  6mm

-  8mm

-  10mm

-  12mm

-  16mm

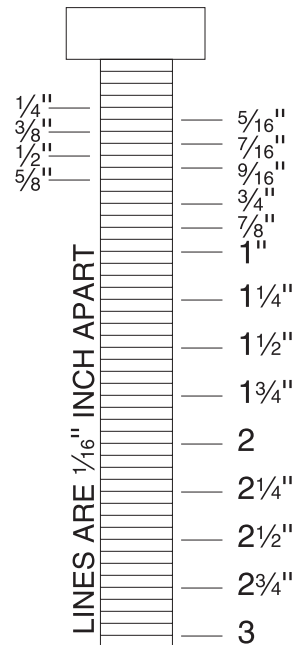
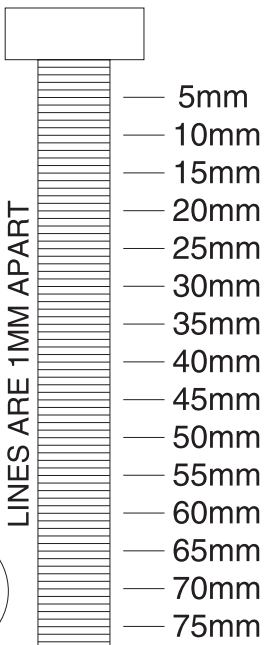
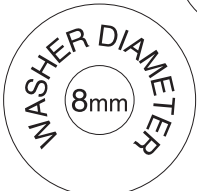
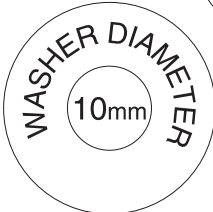
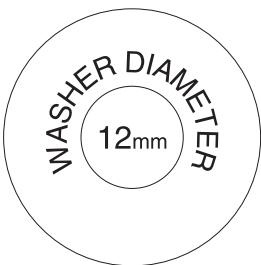
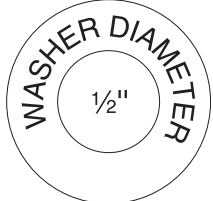
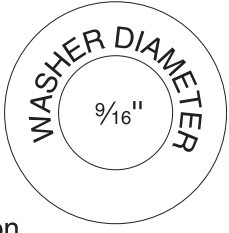
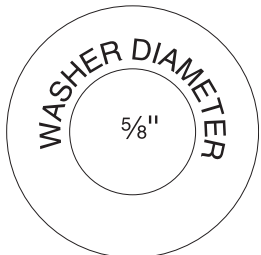
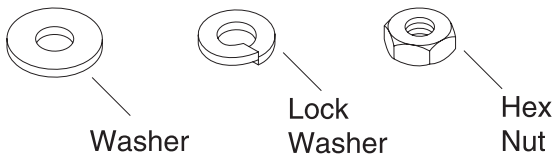
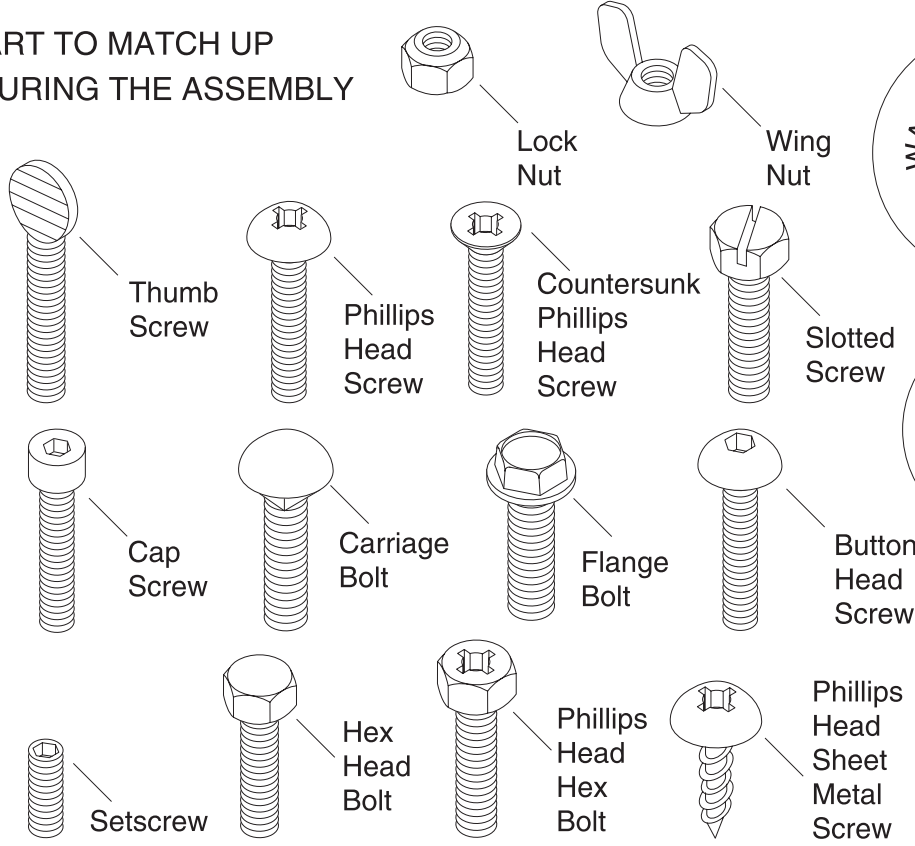

WASHERS ARE MEASURED BY THE INSIDE DIAMETER

Clean Up

The unpainted surfaces are coated with a waxy oil to protect them from corrosion during shipment. Remove this protective coating with a solvent cleaner or citrus-based degreaser such as Grizzly's G7895 Degreaser. To clean thoroughly, some parts may need to be removed. **For optimum performance from your machine, make sure you clean all moving parts or sliding contact surfaces that are coated.** Avoid chlorine-based solvents as they may damage painted surfaces should they come in contact.

	<p>⚠️ WARNING Do not use gasoline or other petroleum-based solvents to clean with. They have low flash points which make them extremely flammable. A risk of explosion and burning exists if these products are used.</p>
--	--

	<p>⚠️ WARNING Do not smoke while using solvents. A risk of explosion or fire exists and may result in serious personal injury.</p>
---	---

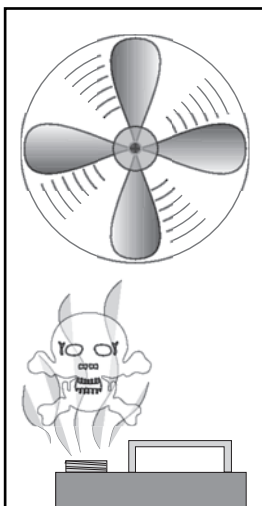
	<p>⚠️ CAUTION Many of the solvents commonly used to clean machinery can be toxic when inhaled or ingested. Lack of ventilation while using these solvents could cause serious personal health risks or fire. Take precautions from this hazard by only using cleaning solvents in a well ventilated area.</p>
---	--

Site Considerations

Floor Load

The Model G0512 weighs 235 lbs. and has a 14½" x 32" footprint on the bottom of the stand. Most commercial floors are suitable for your machine. Some residential floors may require additional build up to support both the machine and operator.

Working Clearances

Consider existing and anticipated needs, size of material to be processed through each machine, and space for auxiliary stands, work tables or other machinery when establishing a location for your bandsaw.

Lighting and Outlets

Lighting should be bright enough to eliminate shadow and prevent eye strain. Electrical circuits should be dedicated or large enough to handle amperage requirements. Outlets should be located near each machine so power or extension cords are clear of high-traffic areas. Observe local electrical codes for proper installation of new lighting, outlets, or circuits.

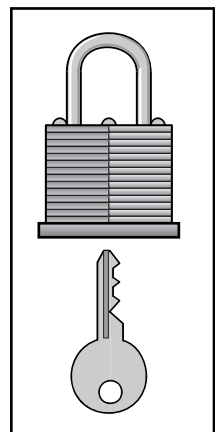
	<p>⚠️ CAUTION Unsupervised children and visitors inside your shop could cause serious personal injury to themselves. Lock all entrances to the shop when you are away and DO NOT allow unsupervised children or visitors in your shop at any time!</p>
--	--

Beginning Assembly

This section will cover the minimum assembly and adjustment instructions needed to begin operation. For best results, complete the assembly in the order provided in this manual and then read the remaining portion of the manual before attempting any type of operations.

Safety must come first! Read and follow these instructions before beginning assembly:

	<p>⚠️ WARNING Wear safety glasses during the entire assembly process. Failure to comply may result in serious personal injury.</p>
---	---

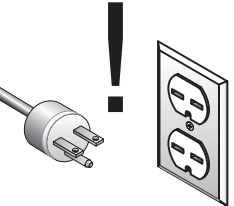
	<p>⚠️ WARNING Disconnect power to the machine when performing all assembly steps. Failure to do this may result in serious personal injury.</p>
--	--

	<p>⚠️ CAUTION Some metal parts may have sharp edges on them after they are formed. Please examine the edges of all metal parts before handling them. Failure to do so could result in injury.</p>
---	--

Most of your Edge Sander has been assembled at the factory, but some parts must be assembled or installed after delivery.



Installing Feet

To install the feet on the sander:

1. Thread the feet into the bottom of the stand as shown in **Figure 5**.

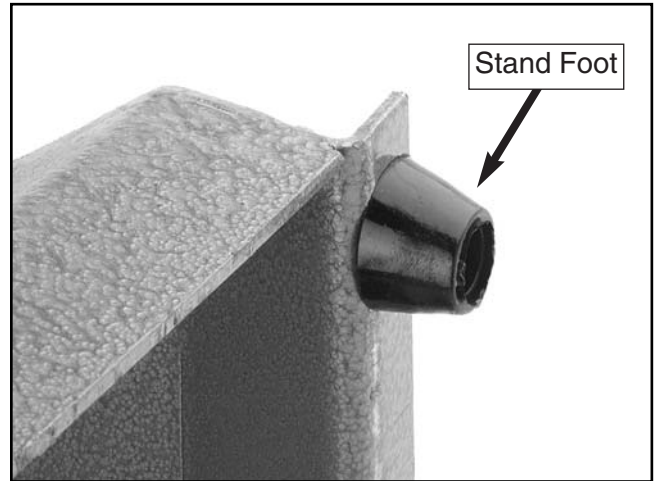

Figure 5. Stand foot threaded onto stand.



Installing Tension Lever

To install the tension lever:

1. Thread the end of the tension lever into the swivel assembly as shown in **Figure 6**.

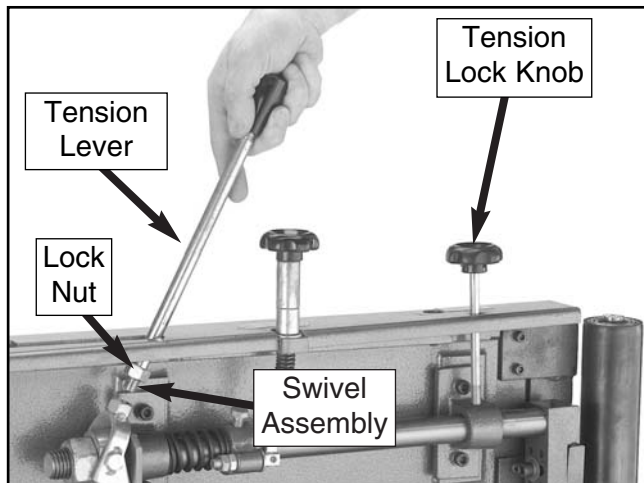

Figure 6. Installing tension lever in swivel assembly.

2. Tighten the lock nut against the swivel assembly to secure the tension lever.



Installing Sanding Belt

To install the sanding belt:

1. Make sure the tension lock knob is loosened.
2. Move the tension lever into the release position as shown in **Figure 7**.

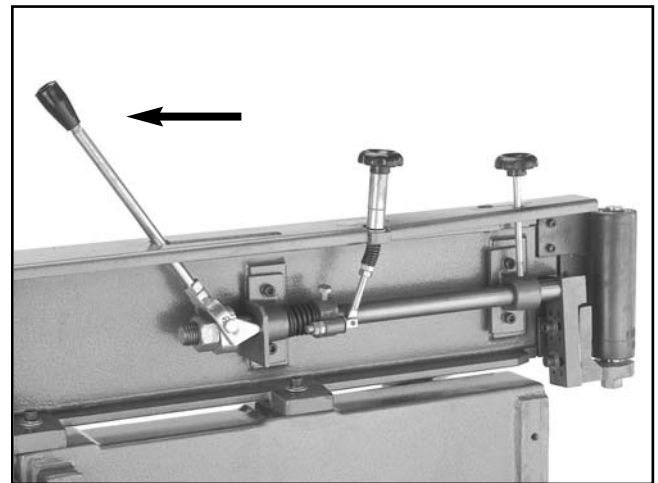

Figure 7. Tension lever in release position.

3. Make sure the arrows on the inside of the belt point in the counter-clockwise direction, and place the sanding belt over both rollers as shown in **Figure 8**.

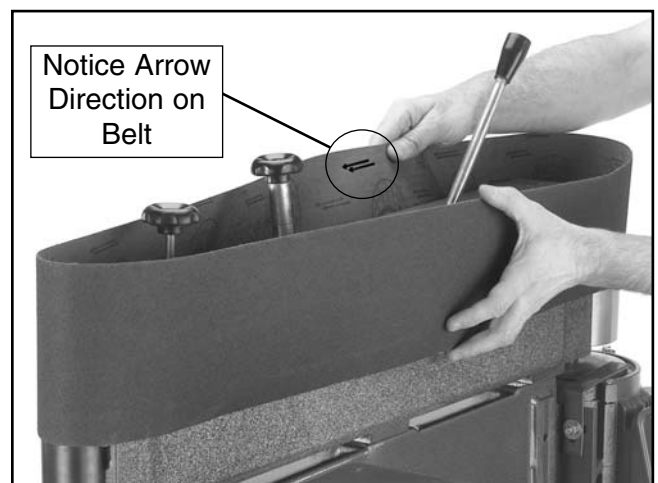

Figure 8. Installing sanding belt.



Attaching Dust Port

To attach the dust port:

1. Attach the dust port to the support brackets with the three $\frac{5}{16}$ "-18 x $\frac{1}{2}$ " hex bolts and washers, as shown in **Figure 9**, but DO NOT completely tighten the bolts yet.

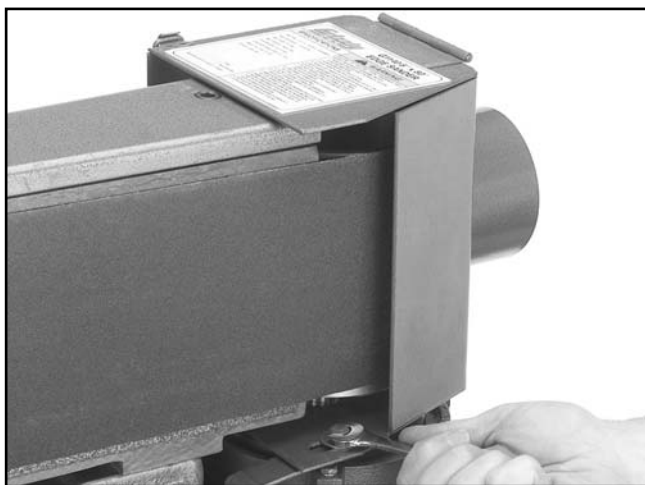

Figure 9. Dust port attached to brackets.

2. Position the dust port approximately $\frac{1}{2}$ " away from the driver roller and tighten the two attachment bolts from **step 1**.



Connecting Plug to Cord

The voltage you decide to use with your sander will determine which plug and receptacle you install. Read **pages 6 & 7**, in *Section 3: Circuit Requirements* for more information.

Install the plug and receptacle now.



Installing Roller Guard

To install the roller guard:

1. Place the guard on top of the idler roller and secure it in position with the included small star knob, as shown in **Figure 10**.

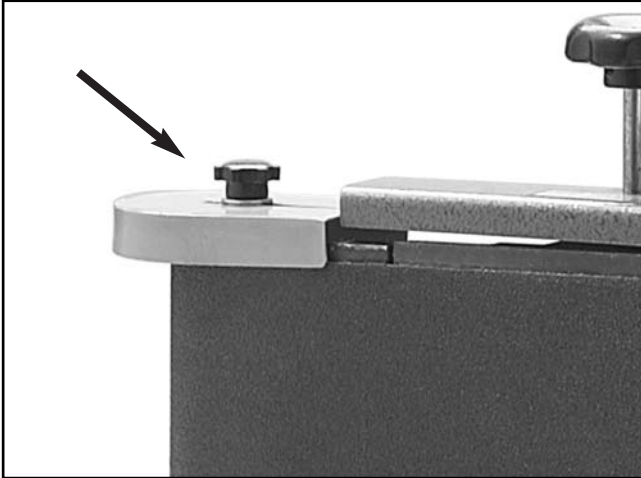

Figure 10. Idler roller guard installed and secured in position with small star knob.



Test Run & Tracking

Before you can install the table, you must run the sander to track the belt. However, you should perform a “pre-tracking” procedure before starting the sander to ensure that the belt does not come off of or bottom out on the rollers during the initial startup.

To pretrack the belt:

1. **Make sure that the sander is disconnected from the power!**
2. Loosen the tracking lock knob.
3. Standing in front of the sander, push the sanding belt multiple times along the platen, so that it moves in the direction of operation (counter-clockwise on the rollers), and watch how the belt tracks on the rollers.
4. Adjust the tracking higher or lower as needed and continue to rotate the belt by hand.
5. Repeat **steps 3 & 4** until the top of the sanding belt rides even with the top of the main roller as shown in **Figure 11**.

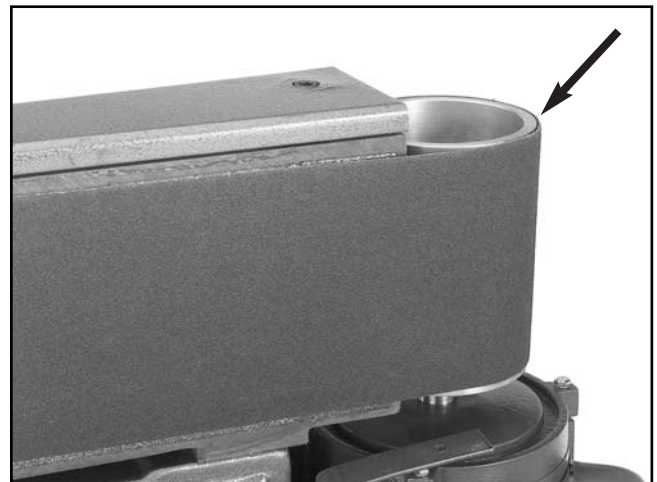

Figure 11. Sanding belt even with top of main roller.

To test run and track the belt:

1. Make sure the belt is properly pre-tracked as described previously.
2. Tie back loose clothing and long hair to protect yourself from getting caught in the moving sanding belt when you start the machine.
3. Make sure the switch is in the down position (OFF), then connect the sander to the power source.

CAUTION

Use extreme caution when preparing for your initial test run. Always keep one finger on the switch in order to quickly STOP the machine in the event of a malfunction or incorrect belt tracking.

4. Start the sander; it should run smoothly with little or no vibration or rubbing noises. Strange or unnatural noises should be investigated and corrected before further operation.

— If noises occur that can not be found by visual inspection, feel free to contact our Service Department for help.

5. Using the tracking control knob, carefully adjust the tracking higher or lower until the top of the sanding belt remains even with the top of the main roller. Note—*The tracking control knob is very sensitive, adjust it with caution.*

6. When the tracking appears to be correct, allow the sander to run for approximately one minute to verify that the tracking stays in the correct position.

— If the tracking does not stay correct, repeat **steps 5 & 6**.

7. When the sanding belt is tracking correctly, tighten the tracking lock knob.

Installing Table

Before installing the table, the sanding belt must be tracking correctly to ensure that the idler roller is close to the position that it will be in during operation.

To install the table:

1. **Disconnect the sander from the power source!**
2. Insert the lead screw assembly as shown in **Figure 12**.

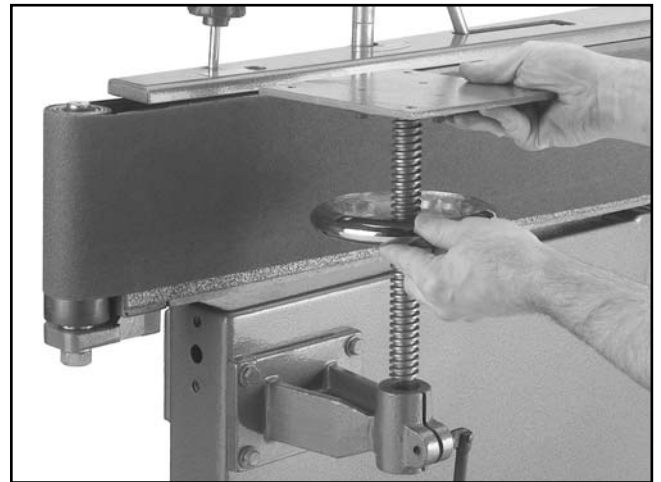

Figure 12. Lead screw assembly installed in bracket.

3. Identify the three table brackets in **Figure 13** before continuing.

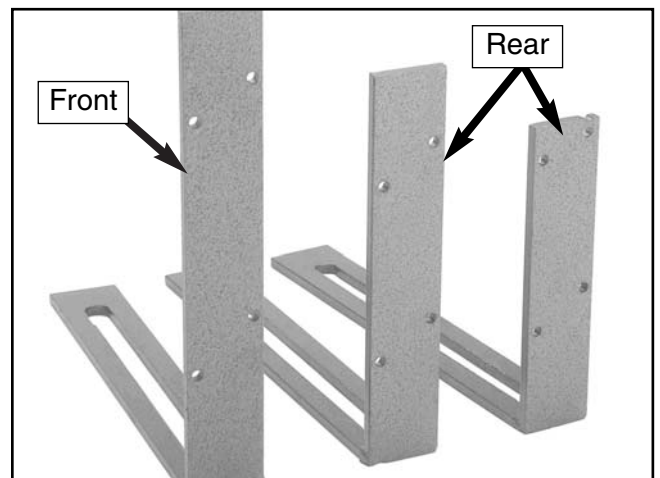

Figure 13. Table brackets laid out for identification.



4. Install the front L support with the lock handle and two $\frac{3}{8}$ " flat washers as shown in **Figure 14**.

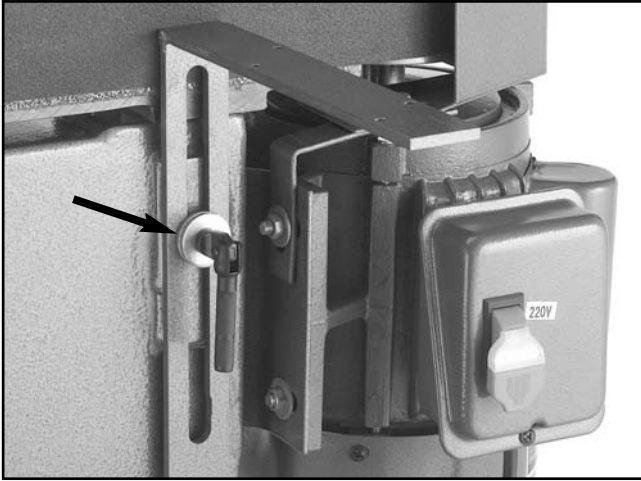

Figure 14. Front L support installed.

5. Install the L supports with the lock handles and remaining four $\frac{3}{8}$ " flat washers as shown in **Figure 15**. The smallest L support at the rear of the machine should be closest to the motor.

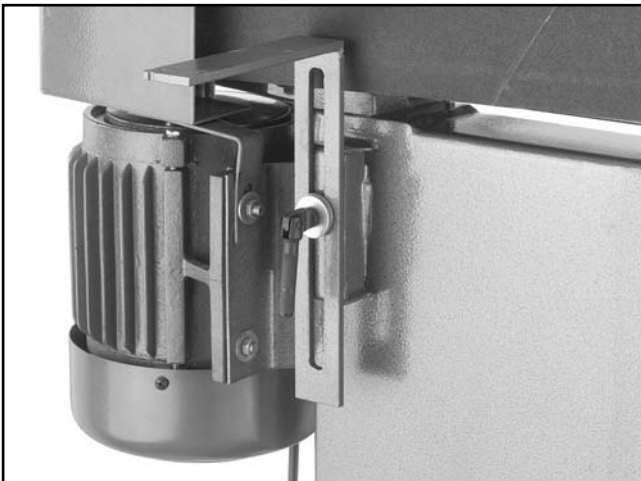

Figure 15. Rear L supports installed.

6. Lower the lead screw support all the way down and adjust all of the L support brackets up to approximately the same height. This will prepare the brackets for the table placement.
7. Place the table on the supports.

8. Use a 3mm or $\frac{1}{8}$ " Allen wrench as a gauge to position the table evenly away from the platen and the idler roller. Do this by placing the Allen wrench as shown in **Figure 16**, at the three locations shown in **Figure 17**.

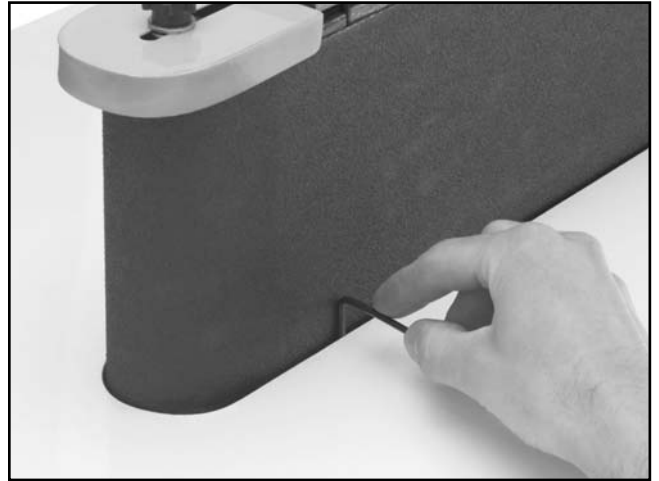

Figure 16. Allen wrench placed between platen and table.

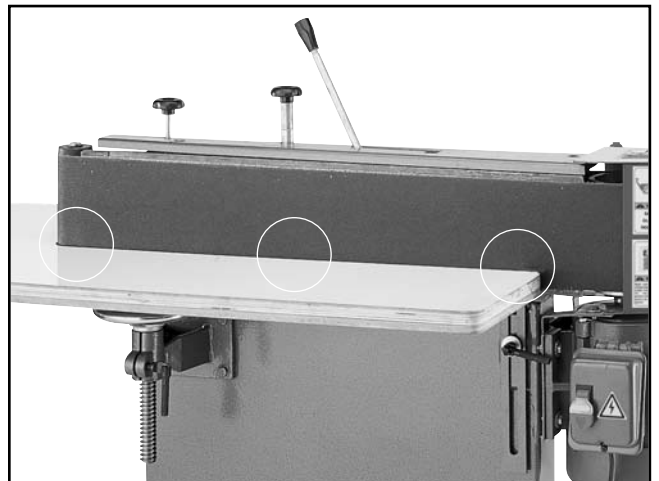

Figure 17. Three places to ensure the spacing between the sanding belt and the table is even.

9. Clamp the table to the supports or have an assistant hold the table in place, and secure the table to the supports with the #8 x $\frac{3}{4}$ " Phillips head tap screws provided in the hardware bag.



Installing Back Stop

To install the back stop:

1. Use a machinists square to position the back stop perpendicular to the platen, on the end of the table that is near the ON/OFF switch.
2. Secure the backstop to the table with three #8 x 3/4" Phillips head tap screws (as shown in **Figure 18**).

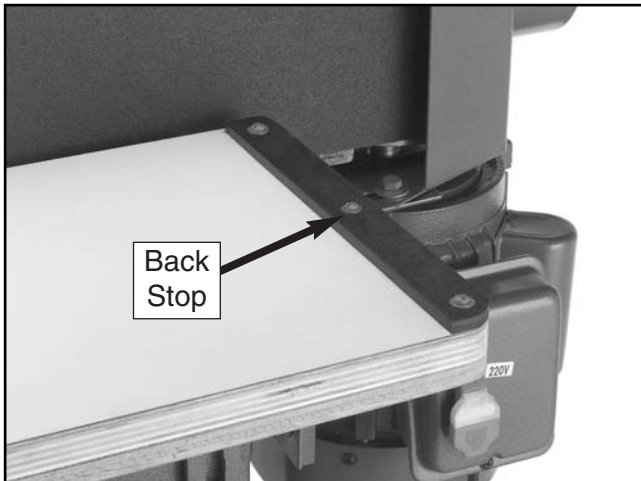

Figure 18. Back stop mounted on table.



Connecting to Dust Collection System

The dust port can be connected to a dust collection system with a 4" hose. However, in order to move the dust from the sander, the dust collection system must be able to move approximately 500 CFM where the hose connects to the dust port. *Note—This number is an approximation and is used for estimation purposes only.*

To connect the dust port to a dust collection system:

1. Slide the 4" hose completely over the dust port as shown in **Figure 19**.

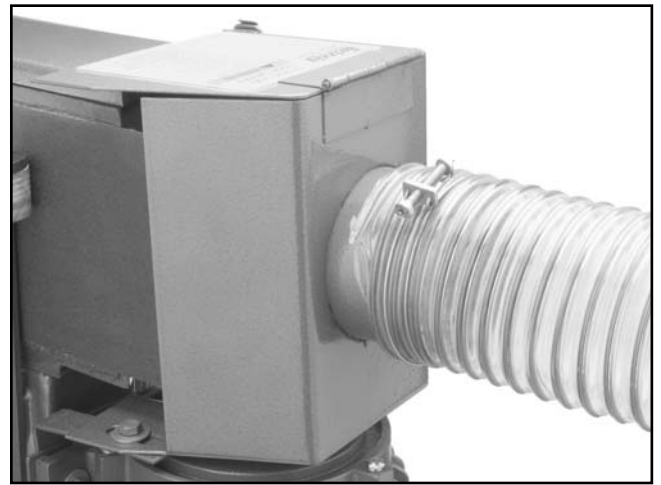

Figure 20. Dust port connected to dust collection system.

2. Tighten the hose clamp to ensure a snug, sealed fit.



SECTION 6: OPERATIONS

Your safety is important! Please follow the warnings below:

⚠️ WARNING

Operating this equipment creates the potential for flying debris to cause eye injury. Always wear safety glasses when operating equipment. Everyday glasses or reading glasses only have impact resistant lenses, they are not safety glasses. Be certain the safety glasses you wear meet the appropriate standards of the American National Standards Institute (ANSI).

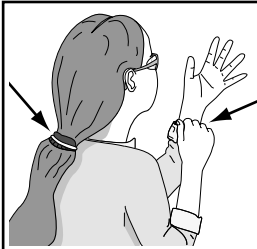

⚠️ WARNING

Keep loose clothing out of the way of machinery and keep hair pulled back during operations.

⚠️ WARNING

Sanding surfaces are capable of causing serious personal injury if they come in contact with fingers, hands, or other body parts. Use extreme care to provide a large buffer area between the sanding belt and any part of your body.

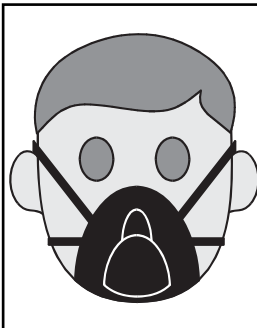

⚠️ CAUTION

Using this machine produces sawdust that may cause short and long-term respiratory illness. Always wear a dust mask when operating this machine.

Power Switch

Besides starting and stopping the sander, the power switch features an important safety lockout key. This key can be removed (as shown in Figure 21) to disable the sander so that it cannot be accidentally started.



Figure 21. Safety key removed from switch.



Adjusting Table Height

The table can be adjusted up or down to allow the operator to use more surface area of the sanding belt. Adjusting the height will also prevent the platen graphite and sanding belt from wearing out in one place.

To adjust the table:

1. Loosen the lock handles that secure the L supports and the lead screw.
2. Turn the lead screw handwheel (shown in **Figure 22**) to raise or lower the table to the desired height.

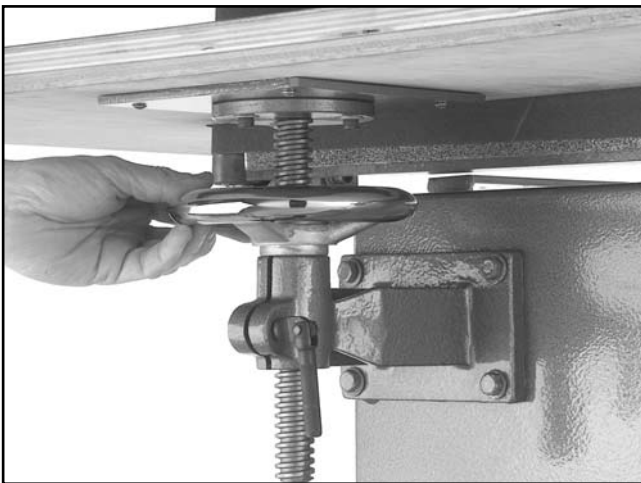

Figure 22. Lead screw handwheel.

3. Tighten all of the lock handles.



Sanding Belt Selection

The Model G0512 accepts a 6" x 80" sanding belt.

There are many types of sanding belts to choose from. We recommend Aluminum Oxide for general workshop environments. Below is a chart that groups abrasive types into different classes, and shows which grits fall into each class.

Grit	Type
60	Coarse
80-100	Medium
120-180	Fine
220	Very Fine

The general rule of thumb is to sand a workpiece with progressively higher grit numbers, with no one grit increase of more than 50.



Edge & End Sanding

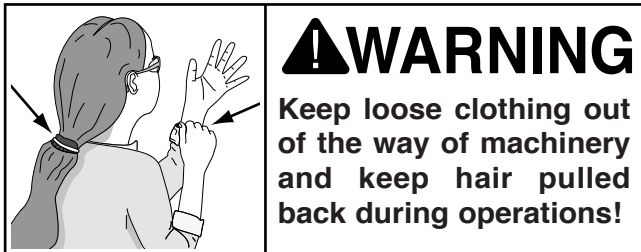

To perform an edge or end sanding operation:

1. Make sure the vertical tracking on the sanding belt is set.
2. Start the sander by pulling the switch up.
3. Support the workpiece against the back stop, keep your fingers away from the moving belt and slowly feed the workpiece into the moving belt, as shown in **Figures 23 & 24**.

⚠ CAUTION

If you must feed a workpiece into the sanding belt corner first, feed the trailing corner first. Feeding the leading corner first, could cause the sanding belt to grab the workpiece and jerk it out of your hands.

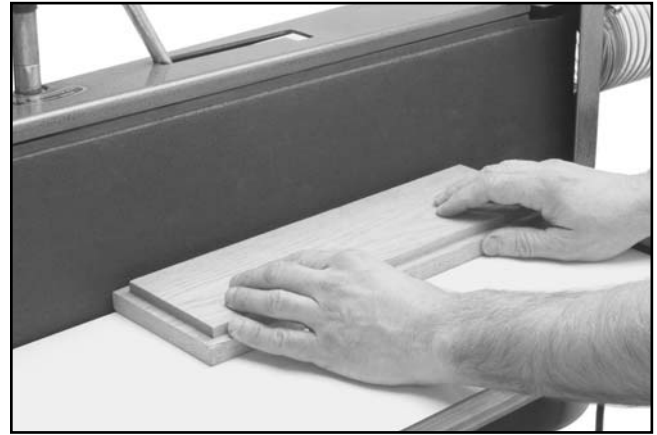

Figure 23. Typical edge sanding operation.



Figure 24. Typical end sanding operation.



Contour Sanding

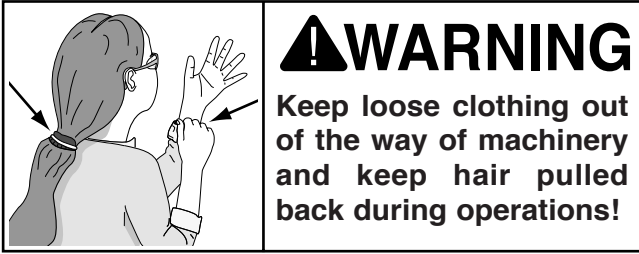

To perform a contour sanding operation:

1. Start the sander by pulling the switch up.
2. Grip the workpiece firmly and feed it into the curved end (as shown in **Figure 25**), and continue moving the workpiece profile along the contour until you achieve your desired shape.

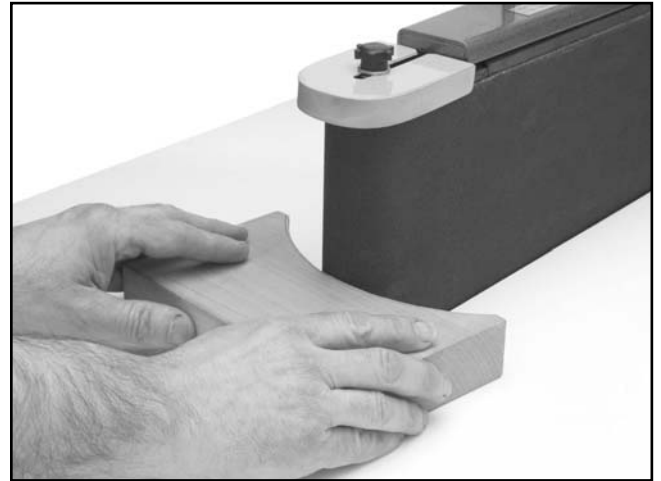

Figure 25. Typical contour sanding operation.



SECTION 7: MAINTENANCE



General

Regular periodic maintenance on your Grizzly Edge Sander will ensure its optimum performance. Make a habit of inspecting your sander each time you use it. Check for the following conditions and repair or replace when necessary.

1. Loose mounting bolts.
2. Worn switch.
3. Worn or damaged cords and plugs.
4. Any other condition that could hamper the safe operation of this machine.



Table

The laminate surface on the table can be wiped clean with a dry towel or cleaned with a solvent designed to remove wood resins if the table is gummy.

DO NOT expose the underside of the table to water because it may warp.



Lubrication

Bearings

Since all bearings are shielded and permanently lubricated, simply leave them alone until they need to be replaced. DO NOT lubricate them.

Table Height Lead Screw

Wipe off built-up sawdust and lubricate with an occasional shot of white lithium grease. After lubricating, be sure to move the lead screw through the full range of motion that it can travel, so that the grease is spread evenly.



Sanding Belt

The sanding belt should be regularly cleaned as it becomes clogged with sawdust. Clean the sanding belt with PRO STIK® belt cleaners (Model G1511/G1512). Belts that are regularly cleaned have a much longer useful life, than belts that are neglected. See **page 31** for more detail on PRO STIK™ belt cleaners.



SECTION 8: SERVICE ADJUSTMENTS

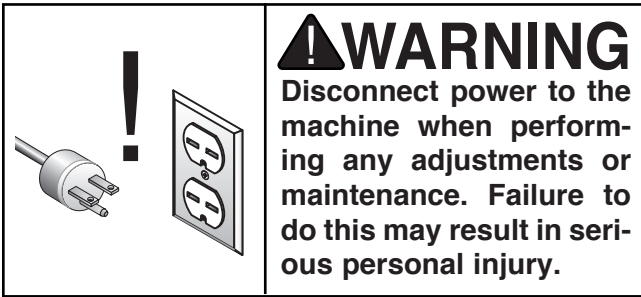

About Service

This section is designed to help the operator with adjustments that were made at the factory and might also need to be made during the life of the machine.

This section is provided for your convenience—it is not a substitute for the Grizzly Service Department. If any adjustments arise that are not described in this manual, then feel free to call the Grizzly Service Department.

Similarly, if you are unsure of how to perform any procedure in this section, the Grizzly Service Department will be happy to guide you through the procedures or help in any other way.



Adjusting Tensioner

The belt tensioner is normally adjusted as the belt stretches. Two good indications of belt stretch (or a loose belt) are if the belt slaps against the plate while running or if it slips on the rollers.

On the other hand, if the belt tension is too tight, you will have a hard time installing and removing the belt when the belt tension is released.

To adjust the belt tensioner:

1. **Disconnect the sander from the power source!**
2. Lower the table as far as it will go.
3. Loosen the tracking lock knob, release the belt tension, and remove the sanding belt from the sander.
4. Move the belt tension lever to the position where the belt is normally tensioned.
5. Locate the belt tension nut and the tracking control bolt shown in **Figure 35**.

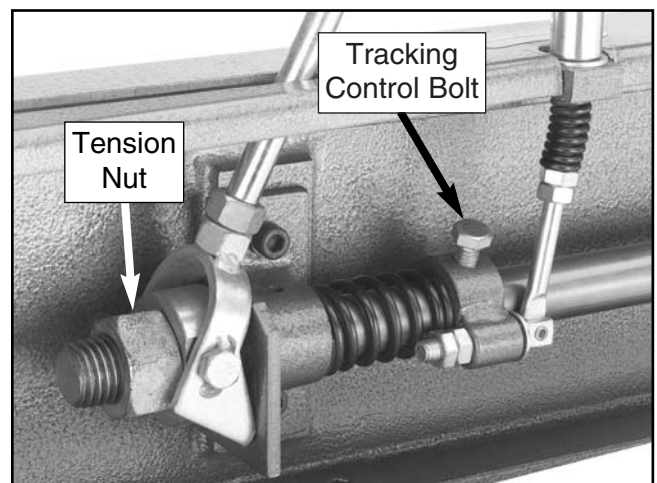

Figure 35. Belt tension nut and tracking control bolt.

6. Rotate the tension nut counter-clockwise to increase the tension and clockwise to decrease the tension.

— *Decreased Tension:* If you rotated the tension nut clockwise, move the belt tension lever to the release position. If it is not too stiff, continue to **step 7**. If it is too stiff to move comfortably, then either the shaft spring tension needs to be reset, the tension shaft needs lubrication, or the idler roller-to-platen relationship needs to be adjusted (**page 29-30**).

— *Increased Tension:* If you rotated the tension nut counter-clockwise, check the beginning movement of the belt tension lever. If there is no play in the first 2" of travel, continue to **step 7**. If there is play in the first 2", then the tension shaft spring tension needs to be reset, as described in the next sub-section.

7. Replace the sanding belt and examine the effect of the tension adjustment on your belt. Repeat the adjustment procedure if necessary.



Resetting Tensioner Spring Tension

The tensioner spring (shown in **Figure 36**) applies pressure to the sanding belt when the belt tension lever is in the tension position. When repeated adjustments are made to the tensioner nut, the spring tension may lose the original setting from the factory, at which point it will need to be reset.

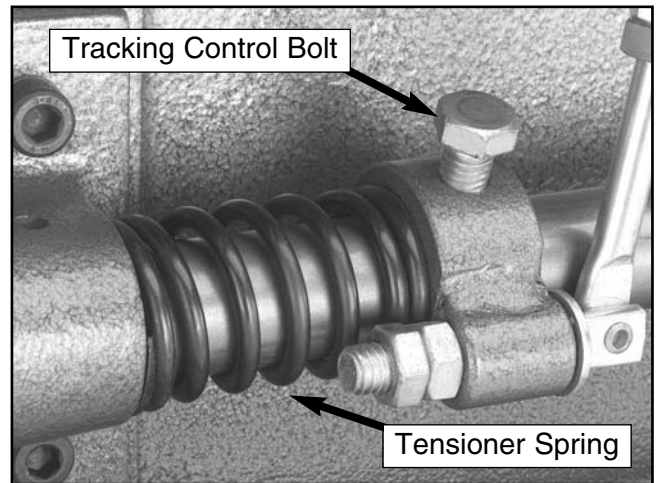

Figure 36. Tensioner spring and tracking control bolt.

To reset the tensioner spring:

1. **Disconnect the sander from the power source!**
2. Remove the table from the sander.
3. Loosen the tracking lock knob and remove the sanding belt from the sander.
4. Move the belt tension lever to the tension position.

- Turn the tension nut counter-clockwise until the threads of the tension shaft are flush with the nut, as shown in **Figure 37**.

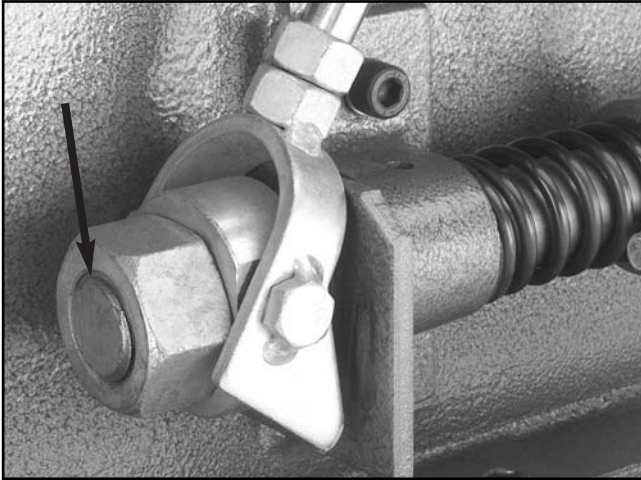

Figure 37. Tension nut flush with threads.

- Loosen the tracking control bolt (**Figure 36, page 25**).
- Pull on the idler roller to take up the slack in the tension shaft.
- Tighten the tracking control bolt.
- Turn the tension nut clockwise approximately three full turns.
- Engage and disengage the belt tension lever, then tighten the tension nut two more full turns.
- Adjust the idler roller-to-platen relationship as described on **pages 29-30**.
- Install the sanding belt and table, and track the sanding belt before operating the sander. Note—*It may be necessary to slightly adjust the tension nut to make the table fit.*



Parallel Belt Tracking

The belt should track on the rollers so that the top edge of the sanding belt stays parallel with the top edge of the platen graphite, as illustrated in **Figure 38**.

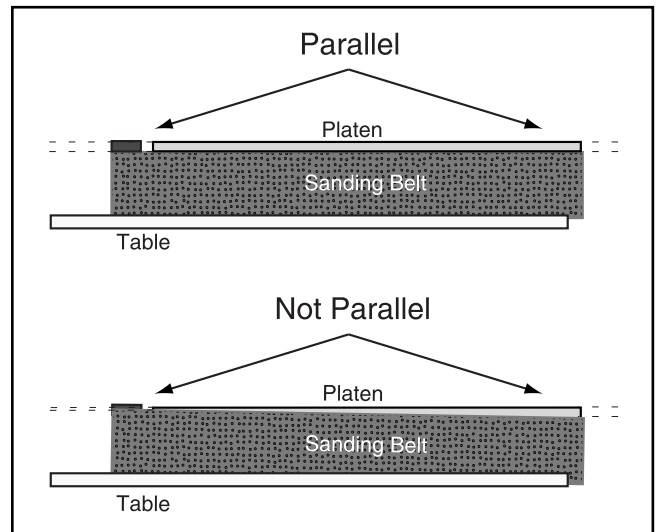

Figure 38. Illustration of parallel belt tracking.

To check the parallel tracking of the sanding belt:

Track the sanding belt, so that the side of the belt that is tracking higher is even with the top of the graphite.

- If the lower side of the belt is more than $\frac{1}{8}$ " away from the top of the graphite, write down the distance between the low side of the belt and the top of the platen, then proceed with the parallel belt tracking instructions.
- If the lower side of the belt is less than $\frac{1}{8}$ " away from the top of the graphite, then you do not need to adjust your belt for parallel tracking.

To adjust the parallel tracking of the sanding belt:

1. **Disconnect the sander from the power source!**
2. Remove the dust port.
3. Remove the table by removing the lock handles, but keeping the L support brackets and elevation plate attached to the table as shown in **Figure 39**.

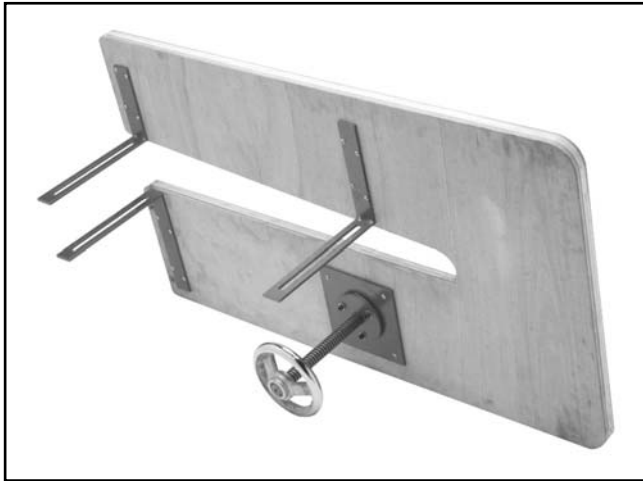

Figure 39. Table removed w/attached supports.

4. Remove the sanding belt.
5. Loosen the two cap screws (shown with black arrows in **Figure 40**) approximately half a turn, and notice the four setscrews nearby (shown with white arrows in **Figure 40**)—these control the parallel tracking of the sanding belt.

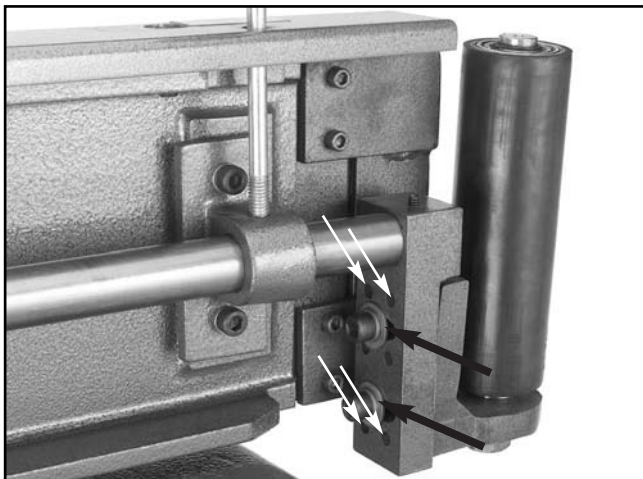

Figure 40. Idler roller adjustment screws.

6. Thread in the necessary two of the four parallel tracking setscrews approximately $\frac{1}{4}$ - $\frac{1}{2}$ a turn, as discussed below.

— If the low side of the belt was on the left end of the sander (as you are standing in front), then thread the two **bottom** setscrews into the plate (clockwise) and unthread (counter-clockwise) the two **top** setscrews out of the plate in the same amount of turns as the bottom setscrews.

— If the low side of the of the belt was on the right end of the sander (as you are standing in front), then evenly thread the two **top** setscrews into the plate (clockwise) and evenly unthread (counter-clockwise) the two **bottom** setscrews out of the plate in the same amount of turns as the top setscrews.

7. Tighten the two cap screws shown in **Figure 40**.
8. Replace and track the belt with the tracking knob, so the side of the belt that is tracking higher (if it is) is even with the top of the graphite.

— If the lower side of the belt is less than $\frac{1}{8}$ " away from the top of the graphite, then you do not need to make further adjustments for parallel tracking.

— If the lower side of the belt is still more than $\frac{1}{8}$ " away from the top of the graphite, estimate how much the belt moved from when you originally checked it. Compare this movement with how much you turned the two setscrews in **step 6**, and then repeat **steps 4-7**, but adjust the setscrews discussed in **step 6** the amount that you estimate will fix the parallel tracking. Repeat as necessary until the parallel tracking is correct.



Platen-to-Rollers Adjustments

The platen can be adjusted forward or backward in relation to the main and idler rollers. When the platen is correctly adjusted, it should extend beyond the rollers approximately $\frac{1}{8}$ ". If the platen extends beyond this, the belt will stretch and the graphite pad will wear quicker.

Because the idler roller is attached to the platen, it will need to be adjusted independently to complete this procedure.

Also, if the main roller is not vertically parallel with the platen, the motor will need to be adjusted on the motor mount to complete this procedure.

Instructions for all three adjustments will be given below. First, check the platen-to-roller relationship to see if you need to make the adjustments.

To check the platen-to-main roller relationship:

1. **Disconnect the sander from the power source!**
2. Remove the sanding belt and dust port.
3. Place a straightedge across the TOP part of the platen graphite and the main roller as shown in **Figure 41**. Measure the gap, if there is one, between the straightedge and the main roller.



Figure 41. Checking top of platen-to-roller.

4. Now place the straightedge across the BOTTOM part of the platen graphite and the main roller as shown in **Figure 42**. Measure the gap, if there is one, between the straightedge and the main roller.

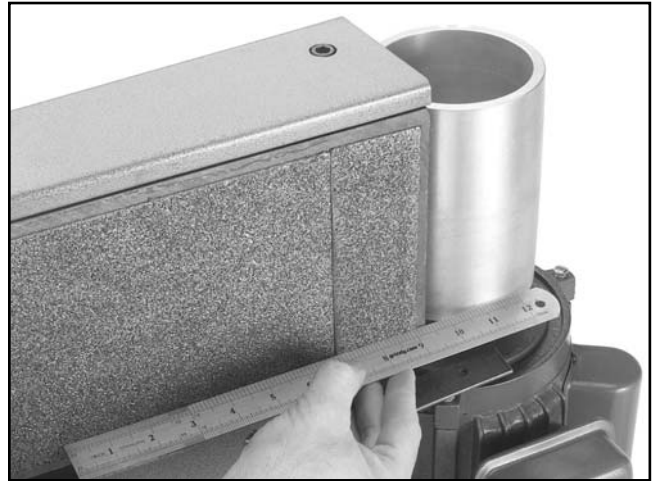

Figure 42. Checking bottom of platen-to-roller.

5. Analyze the results of your check in **steps 3-4**, using the criteria below:
 - *Correct Platen-to-Main Roller Relationship:* The distance between the straightedge and the main roller is approximately $\frac{1}{8}$ " at both the top and bottom. No adjustments are necessary to the platen position or the main roller position.
 - *Platen Incorrect:* The distances between the straightedge and the main roller at both the top and bottom are more or less than $\frac{1}{8}$ ", but the distances at both the top and bottom are approximately the same. The platen needs to be adjusted.
 - *Main Roller Incorrect:* The distance between the straightedge and the main roller is different at the top than it is at the bottom. The main roller needs to be adjusted.

To check the platen-to-idler roller relationship:

1. Follow **steps 1–2** from the previous instructions.

2. Place the straightedge across the TOP of the platen graphite and the idler roller. Measure the gap, if there is one, between the straightedge and the main roller.
3. Place the straightedge across the BOTTOM of the platen graphite and the idler roller. Measure the gap, if there is one, between the straightedge and the main roller.

— *Correct Platen-to-Idler Roller Relationship:* The distance between the straightedge and the idler roller is approximately $\frac{1}{8}$ " at both the top and bottom. No adjustments are necessary to the idler roller position.

— *Idler Roller Incorrect:* The distances between the straightedge and the main roller at both the top and bottom are more or less than $\frac{1}{8}$ ". Adjust the idler roller.

To adjust the main roller-to-platen relationship:

1. **Disconnect the sander from the power source!**
2. Remove the sanding belt and dust port.
3. Loosen the four motor mount bolts/nuts that secure the motor to the motor bracket. **Figure 43** shows two of the four motor mount bolts.

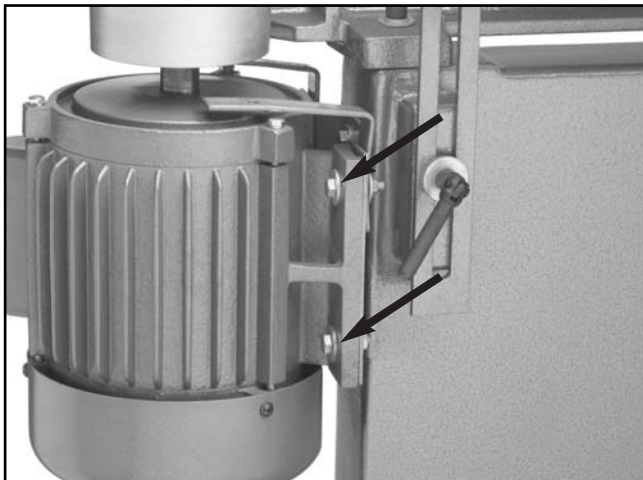

Figure 43. Two of the four motor mount bolts.

4. Place a straightedge across the TOP part of the platen graphite and the main roller, and adjust the main roller so that it is even with the platen graphite at both the top and bottom of the roller. Note—*You can also adjust the motor approximately $\frac{1}{8}$ " behind the platen and skip **step 7**, but this alternative may be more more complicated.*
5. Tighten the motor mount bolts carefully, making sure not to move the motor from its corrected position.
6. Recheck the main roller-to-platen alignment.
 - If the alignment is correct, then it is adjusted correctly. Proceed to **step 7**.
 - If the alignment is incorrect, repeat **steps 3-5**.
7. Adjust the platen as described on the previous page.
8. Replace the sanding belt and dust port, and retrack the sanding belt with the tracking knob before resuming sanding operations.

To adjust the idler roller-to-platen relationship:

1. **Disconnect the sander from the power source!**
2. Remove the sanding belt.

3. Loosen the two cap screws, shown in **Figure 44**, approximately one full turn.

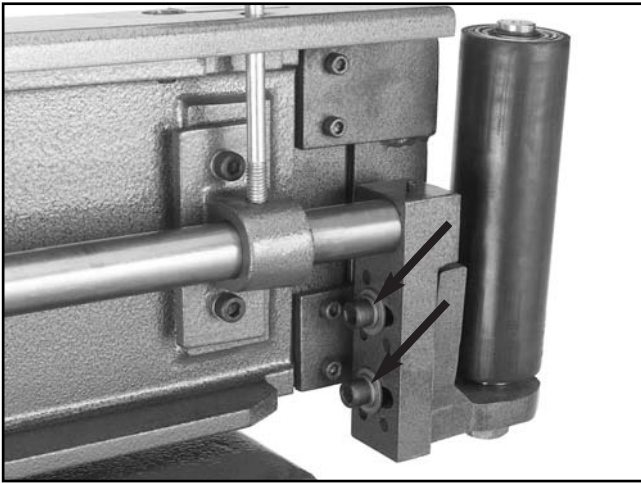

Figure 44. Idler roller adjustment cap screws.

4. Place a straightedge across the TOP part of the platen graphite and in front of the idler roller, and adjust the idler roller so that it is approximately $\frac{1}{8}$ " away from the straightedge.
5. Place a straightedge across the BOTTOM part of the platen graphite and in front of the idler roller, and adjust the idler roller so that it is approximately $\frac{1}{8}$ " away from the straightedge.
6. Check the adjustments made in **steps 5-6**, and tighten the cap screws that you loosened in **step 3**, making sure not to move the corrected idler roller position during tightening.
7. Replace the sanding belt and dust port, and retrack the sanding belt with the tracking knob before resuming sanding operations.

The platen can also be adjusted, but this adjustment should be done carefully because moving the platen too far will make the sanding belt press against the table.

To adjust the platen:

1. **Disconnect the sander from the power source!**
2. Remove the sanding belt and dust port.

3. Loosen the two cap screws shown in **Figure 45**.

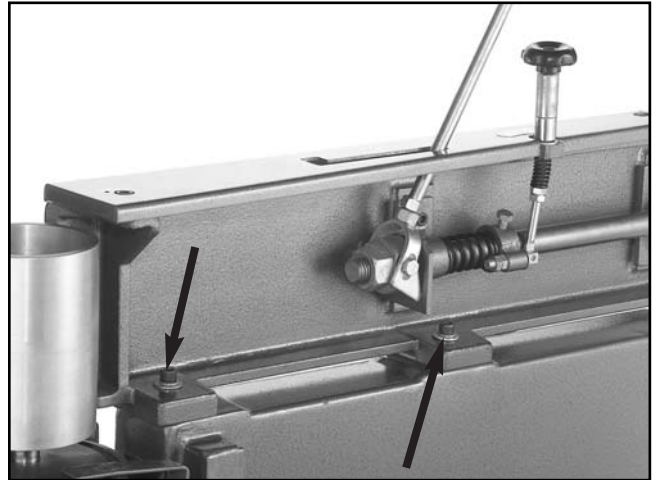

Figure 45. The two cap screws that secure the platen for adjustments.

4. Place a straightedge across the platen graphite and in front of the main roller.
5. Adjust the platen so the distance between the straightedge and main roller is approximately $\frac{1}{8}$ ".
6. Tighten both cap screws in an even manner and recheck the distance between the platen and the main roller to make sure that it did not move when you tightened the cap screws.
 - If the platen did move, repeat **steps 3-5** until it is positioned properly.
 - If the platen did not move, then it is adjusted correctly. Proceed to **step 7**.
7. Replace the sanding belt and dust port, and retrack the sanding belt with the tracking knob before resuming sanding operations.



SECTION 9: REFERENCE INFO

The following pages contain troubleshooting, the wiring diagram, general machine data, parts diagrams, parts lists and Warranty/Return information for your Model G0512.

If you need parts or help in assembling your machine, or if you need operational information, call the Grizzly Service Department. Trained service technicians will be glad to help you.

If you have any comments regarding this manual, please write to Grizzly at the address below:

Grizzly Industrial, Inc.
% Technical Documentation
P.O. Box 2069
Bellingham, WA 98227-2069

We recommend you keep a copy of our current catalog for complete information regarding Grizzly's warranty and return policy. If you need additional technical information relating to this machine, or if you need general assistance or replacement parts, please contact the Service Department at the location listed below.

Grizzly Industrial, Inc.
1203 Lycoming Mall Circle
Muncy, PA 17756
Phone: (570) 546-9663
Fax: (800) 438-5901
E-Mail: techsupport@grizzly.com
Web Site: <http://www.grizzly.com>



Aftermarket Accessories

To order any of the aftermarket accessories below, call our customer service line 24 hours a day at 1-800-523-4777.

Extra 6" x 80" Belts

<u>Grit</u>	<u>Model</u>
60	G1532
80	G4287
100	G1533
120	G4288
150	G1534
180	G4289
220	G4290

PRO-STICK® Abrasive Belt Cleaners

Extend the life of your belts!

<u>Size</u>	<u>Model</u>
1½" X 1½" X 8½"	G1511
2" X 2" X 12"	G1512



Figure 46. PRO-STIK® Abrasive Belt Cleaners.





MACHINE DATA SHEET

Customer Service #: (570) 546-9663 • To Order Call: (800) 523-4777 • Fax #: (800) 438-5901

GRIZZLY MODEL G0512 HEAVY-DUTY EDGE SANDER

Design Type Expanded Table, Floor Model

Overall Dimensions and Specifications:

Table Size24" x 42¹/₄"
 Overall Height (With Handle Up)48³/₄"
 Table Height33"-39"
 Length.....52¹/₂"
 Width24"
 Platen Size.....6¹/₄" x 31¹/₂", Graphite Coated
 Belt Size6" x 80"
 Belt Speed1800 FPM
 Shipping Weight.....250 lbs.
 Machine Weight235 lbs.
 Footprint14¹/₂" x 32"

Construction:

BaseWelded Steel - Powder Coated
 TableComposite w/ Formica Surface
 Rubber Idler Roller.....Shielded Ball Bearing, 2¹/₈"
 Drive RollerCast Aluminum, 4¹/₂"

Motor:

TypeTEFC Capacitor Start Induction
 Horsepower1¹/₂ HP
 Phase / Voltage Single Phase / 110V / 220V; Prewired 220V
 Amps20 / 10
 Cycle and RPM60 Hertz / 1725 RPM
 SwitchToggle Safety Switch w/ Safety Lock Tab
 Power TransferDirect Drive
 BearingsShielded & Lubricated Ball Bearings

Features:

.....Extended Sanding Surface
Work Stop
4" Dust Port
Quick Belt Release
Belt Tracking and Tension Adjustment
Handwheel Table Height Adjustment
Powder Coated Stand

Specifications, while deemed accurate, are not guaranteed.

Parts Breakdown and List

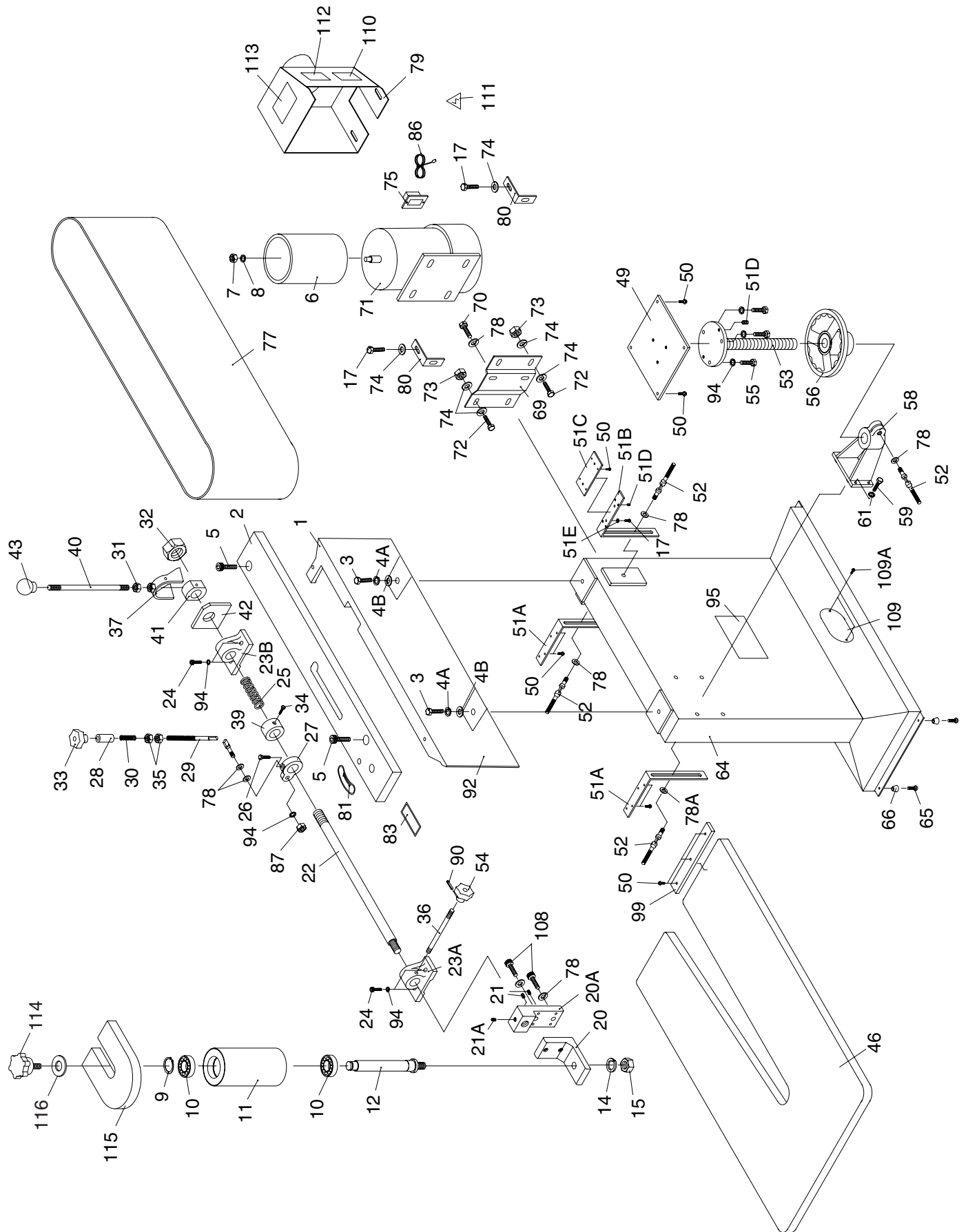

REF	PART #	DESCRIPTION
1	P0512001	PLATEN
2	P0512002	PLATEN COVER
3	PB16	HEX BOLT 3/8"-16 X 1 1/2"
4A	PLW06M	LOCK WASHER 10MM
4B	PW02	FLAT WASHER 3/8"
5	PSB14	CAP SCREW 3/8"-16 X 1"
6	P0512006	DRIVER ROLLER
7	PN09	HEX NUT 5/8"-18
8	PLW10M	LOCK WASHER 16MM
9	PR08M	EXT RETAINING RING 19MM
10	P0512010	BALL BEARING R12-Z
11	P0512011	RUBBER IDLER ROLLER
12	P0512012	ROLLER AXLE
14	PLW10M	LOCK WASHER 16MM
15	PN04	HEX NUT 5/8"-11
17	PB09	HEX BOLT 5/16"-18 X 1/2"
20	P0512020	ROLLER SUPPORT BRACKET
20A	P0512020A	ROLLER BLOCK BRACKET
21	PSS10	SET SCREW 1/4"-20 X 5/8"
21A	P0512021A	SPECIAL SCREW 1/4"-20 X 5/8"
22	P0512022	BELT ADJUST SHAFT
23A	P0512023A	ADJUST SHAFT SLIDE (A)
23B	P0512023B	ADJUST SHAFT SLIDE (B)
24	PSB03	CAP SCREW 5/16"-18 X 1
25	P0512025	SPRING
26	PB07	HEX BOLT 5/16"-18 X 3/4"
27	P0512027	ARM CONTROL CASTING
28	P0512028	SLEEVE
29	P0512029	CONTROL SHAFT
30	P0512030	SPRING
31	PN13	HEX NUT 1/2"-13
32	PN22	HEX NUT 1-8
33	P0512033	TILT KNOB 3/8"
34	PB21	HEX BOLT 3/8"-16 X 3/4"
35	PN08	HEX NUT 3/8"-16
36	P0512036	LOCK KNOB STUD 3/8" X 5 3/8"
37	P0512037	SWIVEL ASSEMBLY
39	P0512039	COLLAR
40	P0512040	LEVER
41	P0512041	SWIVEL ASSEMBLY
42	P0512042	PLATE
43	P0512043	HANDLE 1/2"
46	P0512046	TABLE
49	P0512049	PARTITION
50	PHTEK11	PHLP HD TAP SCREW #8 X 3/4"
51A	P0512051A	TABLE SUPP BRACKET (A)
51B	P0512051B	TABLE SUPP BRACKET (B)
51C	P0512051C	ADJUSTMENT PLATE

REF	PART #	DESCRIPTION
51D	PSS02	SETSCREW 5/16"-18 X 3/8"
52	P0512052	SWIVEL HANDLE 3/8" X 1 1/4"
53	P0512053	LEAD SCREW
54	P0512054	KNOB 3/8"
55	PB32	HEX BOLT 5/16"-18 X 5/8"
56	P0512056	HAND WHEEL
58	P0512058	SPLIT CASTING
59	PB18	HEX BOLT 3/8"-16 X 1"
61	PLW06M	LOCK WASHER 10MM
64	P0512064	STAND
65	PS22	PHLP HD SCR 10-24 X 5/8"
66	P0512066	RUBBER FOOT
69	P0512069	MOTOR BRACKET
70	PB18	HEX BOLT 3/8"-16 X 1"
71	P0512071	MOTOR 1 1/2HP
71-1	P0512071-1	MOTOR FAN COVER
71-2	P0512071-2	MOTOR FAN
71-3	P0512071-3	MOTOR WIRING CAP
71-4	PC400A	CAPACITOR 400MFD 125VAC
71-5	P0512071-5	CAPACITOR COVER
72	PB12	HEX BOLT 5/16"-18 X 1 1/4"
73	PN02	HEX NUT 5/16"-18
74	PW07	FLAT WASHER 5/16"
75	G8988	SWITCH
77	G1532	SANDING BELT 6" X 80"
78	PW02	FLAT WASHER 3/8"
79	P0512079	DUST COLLECTION HOOD
80	P0512080	LEFT BRACKET
81	P0512081	TRACKING ARROW LABEL
83	P0512083	TRACKING LOCK LABEL
86	PWRCRD220L	POWER CORD 2 POLE/3 WIRE
87	PN08	HEX NUT 3/8"-16
90	PRP37M	ROLL PIN 3 X 14
92	P0512092	GRAPHITE PAD
94	PLW04M	LOCK WASHER 8MM
95	P0512095	MACHINE ID LABEL
99	P0512099	BACK STOP
108	PSB26	CAP SCREW 3/8"-16 X 1 1/2"
109	G8588	GRIZZLY LOGO PLATE
109A	PHTEK10	TAP SCREW #8 X 5/8"
110	PLABEL-12	READ MANUAL LABEL
111	PLABEL-14	ELECTRICITY LABEL
112	PLABEL-11	SAFETY GLASSES LABEL
113	PLABEL-13	UNPLUG SANDER LABEL
114	P0512114	SMALL STAR KNOB
115	P0512115	IDLER ROLLER COVER
116	PW06	FLAT WASHER 1/4"

Troubleshooting Machine

SYMPTOM	POSSIBLE CAUSE	CORRECTIVE ACTION
Motor will not start.	<ol style="list-style-type: none"> 1. Low voltage. 2. Open circuit in motor or loose connections. 	<ol style="list-style-type: none"> 1. Check power line for proper voltage. 2. Inspect all lead connections on motor for loose or open connections.
Motor will not start; fuses or circuit breakers blow.	<ol style="list-style-type: none"> 1. Short circuit in line cord or plug. 2. Short circuit in motor or loose connections. 3. Incorrect fuses or circuit breakers in power line. 	<ol style="list-style-type: none"> 1. Inspect cord or plug for damaged insulation and shorted wires. 2. Inspect all connections on motor for loose or shorted terminals or worn insulation. 3. Install correct fuses or circuit breakers.
Motor overheats.	<ol style="list-style-type: none"> 1. Motor overloaded. 2. Air circulation through the motor restricted. 	<ol style="list-style-type: none"> 1. Reduce load on motor. 2. Clean out motor to provide normal air circulation.
Motor stalls (resulting in blown fuses or tripped circuit).	<ol style="list-style-type: none"> 1. Short circuit in motor or loose connections. 2. Low voltage. 3. Incorrect fuses or circuit breakers in power line. 4. Motor overloaded. 	<ol style="list-style-type: none"> 1. Inspect connections on motor for loose or shorted terminals or worn insulation. 2. Correct the low voltage conditions. 3. Install correct fuses or circuit breakers. 4. Reduce load on motor.
Machine slows when operating.	<ol style="list-style-type: none"> 1. Applying too much pressure to work-piece. 2. Undersized circuit or using ext cord. 	<ol style="list-style-type: none"> 1. Sand with less pressure—let the movement of the belt do the work. 2. Make sure circuit wires are proper gauge & don't use ext cords!
Loud, repetitious noise coming from machine.	<ol style="list-style-type: none"> 1. Pulley setscrews or keys are missing or loose. 2. Motor fan is hitting the cover. 	<ol style="list-style-type: none"> 1. Inspect keys and setscrews. Replace or tighten if necessary. 2. Tighten fan or shim cover.
Machine vibrates excessively.	<ol style="list-style-type: none"> 1. Stand not stable on floor. 2. Incorrect motor mounting. 3. Incorrect sanding belt tension. 4. Weak or broken tension spring. 5. Idler roller is too loose. 6. Broken/defective sanding belt. 	<ol style="list-style-type: none"> 1. Secure stand to floor, reposition to level surface, or shim stand. 2. Check/adjust motor mounting. 3. Make sure tension lever is in tensioning position. Follow belt tensioning instructions in this manual. 4. Replace spring. 5. Adjust idler roller. 6. Replace sanding belt.

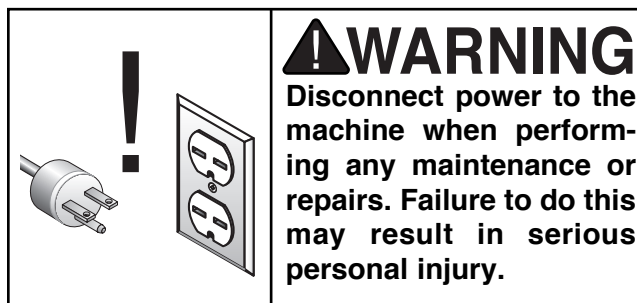

Troubleshooting Sanding

SYMPTOM	POSSIBLE CAUSE	CORRECTIVE ACTION
Deep sanding grooves or marks in workpiece.	<ol style="list-style-type: none"> 1. Sanding belt grit too coarse for the desired finish. 2. Workpiece is being sanded across the grain. 3. Too much sanding force on workpiece. 4. Workpiece held still against the belt. 	<ol style="list-style-type: none"> 1. Use a finer grit sanding belt. 2. Sand with the grain. 3. Reduce pressure on workpiece while sanding. 4. Keep workpiece moving while sanding on the belt.
Grains easily rub off the belt.	<ol style="list-style-type: none"> 1. Sanding belt has been stored in an incorrect environment. 2. Sanding belt has been folded or smashed. 	<ol style="list-style-type: none"> 1. Store sanding belt away from extremely dry or hot temperatures. 2. Hang sanding belt or store unfolded and unstacked.
Glazed sanding belt.	<ol style="list-style-type: none"> 1. Sanding wet stock. 2. Sanding stock with high residue. 	<ol style="list-style-type: none"> 1. Dry stock properly before sanding. 2. Use different stock. Or, accept the characteristics of the stock and plan on cleaning/replacing belts frequently.
Burning marks on workpiece.	<ol style="list-style-type: none"> 1. Using too fine of sanding belt grit. 2. Using too much pressure against belt. 3. Work held still for too long. 	<ol style="list-style-type: none"> 1. Use a coarser grit sanding belt. 2. Reduce pressure on workpiece while sanding. 3. Do not keep workpiece in one place for too long.
Sanding belt clogs quickly or burns.	<ol style="list-style-type: none"> 1. Using too much pressure against belt. 2. Sanding softwood. 	<ol style="list-style-type: none"> 1. Reduce pressure on workpiece while sanding. 2. Use different stock. Or, accept the characteristics of the stock and plan on cleaning/replacing belts frequently.
Workpiece frequently gets pulled out of your hand.	<ol style="list-style-type: none"> 1. Not supporting the workpiece against the stop. 2. Starting the workpiece on a leading corner. 	<ol style="list-style-type: none"> 1. Use back stop to support workpiece. 2. Start workpiece on a trailing corner.
Sanding belt comes off during operation.	<ol style="list-style-type: none"> 1. Tracking out of adjustment. 	<ol style="list-style-type: none"> 1. Track the belt as described in <i>Section: 5 Set Up</i>.

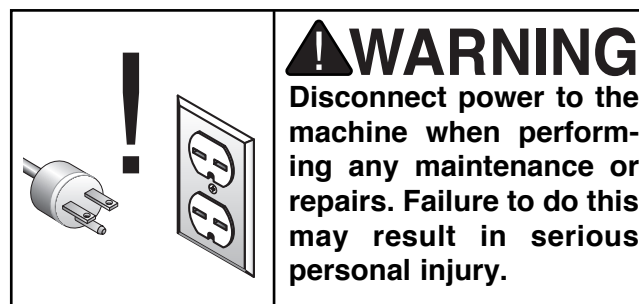

G0512 Wiring Diagram

⚠ DANGER

Disconnect power from machine before performing any electrical service. Failure to do this will result in a shock hazard, leading to injury or death.

NOTE: THE WIRES FROM THE POWER SUPPLY, EXCEPT THE GREEN GROUND WIRE, ARE INTERCHANGABLE, THEREFORE COLORS ARE NOT SPECIFIED.

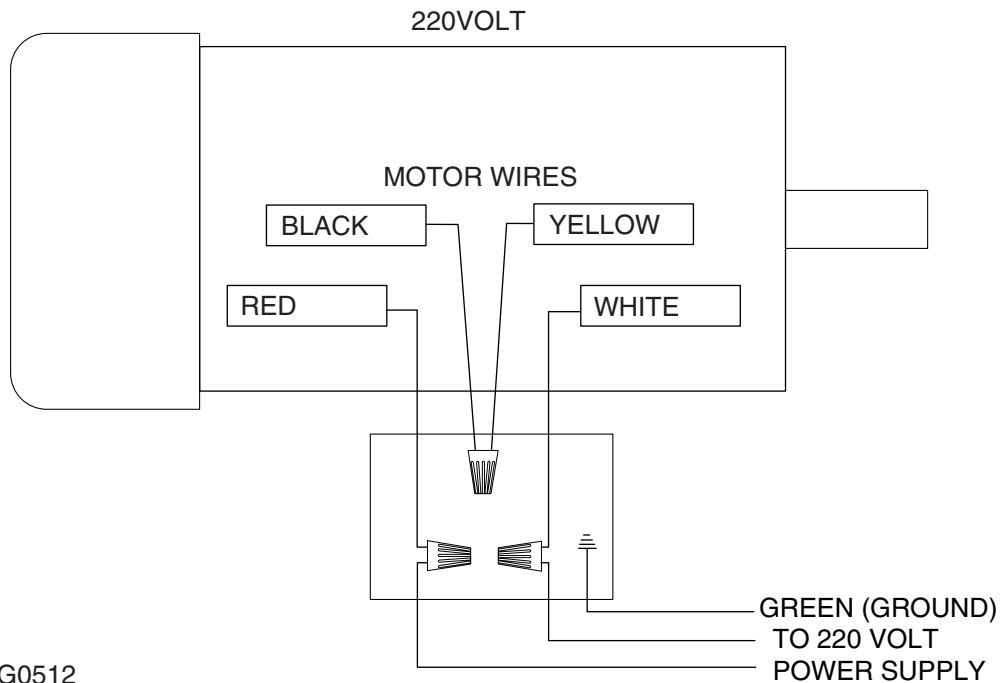
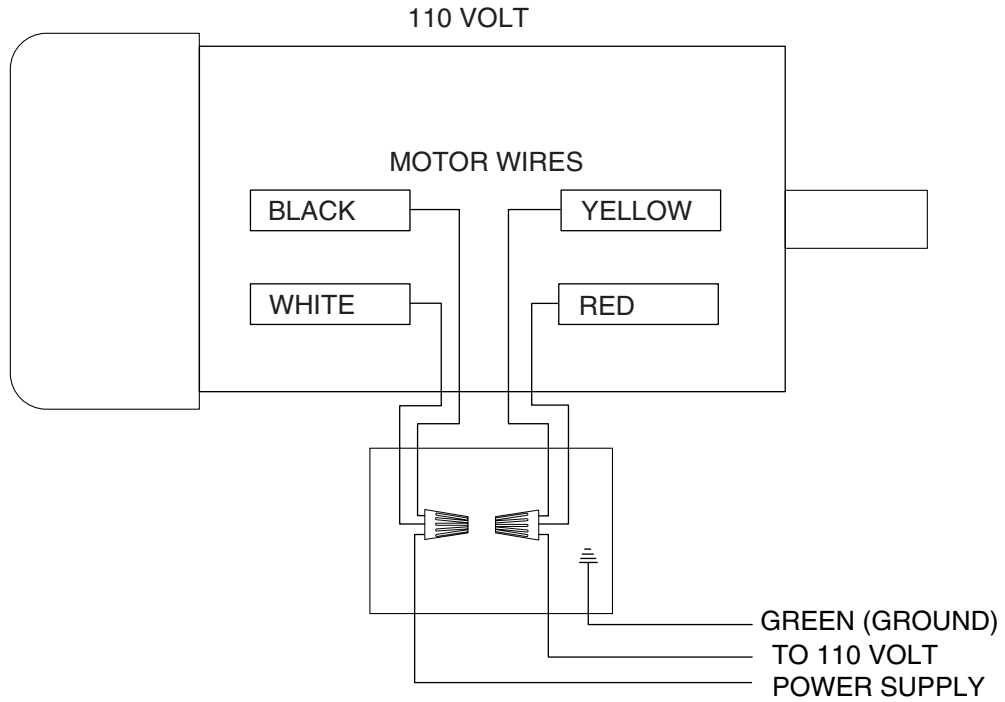

Model G0512

Copyright © May, 2003. Grizzly Industrial, Inc.†

G0512 Edge Sander

Warranty and Returns

Grizzly Industrial, Inc. warrants every product it sells for a period of **1 year** to the original purchaser from the date of purchase. This warranty does not apply to defects due directly or indirectly to misuse, abuse, negligence, accidents, repairs or alterations or lack of maintenance. This is Grizzly's sole written warranty and any and all warranties that may be implied by law, including any merchantability or fitness, for any particular purpose, are hereby limited to the duration of this written warranty. We do not warrant or represent that the merchandise complies with the provisions of any law or acts unless the manufacturer so warrants. In no event shall Grizzly's liability under this warranty exceed the purchase price paid for the product and any legal actions brought against Grizzly shall be tried in the State of Washington, County of Whatcom.

We shall in no event be liable for death, injuries to persons or property or for incidental, contingent, special, or consequential damages arising from the use of our products.

To take advantage of this warranty, contact us by mail or phone and give us all the details. We will then issue you a "Return Number," which must be clearly posted on the outside as well as the inside of the carton. We will not accept any item back without this number. Proof of purchase must accompany the merchandise.

The manufacturers reserve the right to change specifications at any time because they constantly strive to achieve better quality equipment. We make every effort to ensure that our products meet high quality and durability standards and we hope you never need to use this warranty.

Please feel free to write or call us if you have any questions about the machine or the manual.

Thank you again for your business and continued support. We hope to serve you again soon.

WARRANTY CARD

Name _____
Street _____
City _____ State _____ Zip _____
Phone Number _____ E-Mail _____ FAX _____
MODEL # G0512 Edge Sander Serial # _____ Order # _____

The following information is given on a voluntary basis. It will be used for marketing purposes to help us develop better products and services. Of course, all information is strictly confidential.

1. How did you learn about us?
- | | |
|---|------------------------------------|
| <input type="checkbox"/> Advertisement | <input type="checkbox"/> Friend |
| <input type="checkbox"/> Catalog | <input type="checkbox"/> Card Deck |
| <input type="checkbox"/> World Wide Web | |
| ____ Other _____ | |
2. Which of the following magazines do you subscribe to.
- | | |
|--|---|
| <input type="checkbox"/> American Woodworker | <input type="checkbox"/> Practical Homeowner |
| <input type="checkbox"/> Cabinetmaker | <input type="checkbox"/> Shop Notes |
| <input type="checkbox"/> Family Handyman | <input type="checkbox"/> Today's Homeowner |
| <input type="checkbox"/> Fine Homebuilding | <input type="checkbox"/> WOOD |
| <input type="checkbox"/> Fine Woodworking | <input type="checkbox"/> Wooden Boat |
| <input type="checkbox"/> Home Handyman | <input type="checkbox"/> Woodshop News |
| <input type="checkbox"/> Journal of Light Construction | <input type="checkbox"/> Woodsmith |
| <input type="checkbox"/> Old House Journal | <input type="checkbox"/> Woodwork |
| <input type="checkbox"/> Popular Mechanics | <input type="checkbox"/> Woodworker |
| <input type="checkbox"/> Popular Science | <input type="checkbox"/> Woodworker's Journal |
| <input type="checkbox"/> Popular Woodworking | <input type="checkbox"/> Workbench |
| ____ Other _____ | |
3. Which of the following woodworking/remodeling shows do you watch?
- | | |
|--|--|
| <input type="checkbox"/> Backyard America | <input type="checkbox"/> The New Yankee Workshop |
| <input type="checkbox"/> Home Time | <input type="checkbox"/> This Old House |
| <input type="checkbox"/> The American Woodworker | <input type="checkbox"/> Woodwright's Shop |
| ____ Other _____ | |
4. What is your annual household income?
- | | |
|--|--|
| <input type="checkbox"/> \$20,000-\$29,999 | <input type="checkbox"/> \$60,000-\$69,999 |
| <input type="checkbox"/> \$30,000-\$39,999 | <input type="checkbox"/> \$70,000-\$79,999 |
| <input type="checkbox"/> \$40,000-\$49,999 | <input type="checkbox"/> \$80,000-\$89,999 |
| <input type="checkbox"/> \$50,000-\$59,999 | <input type="checkbox"/> \$90,000 + |
5. What is your age group?
- | | |
|--------------------------------|--------------------------------|
| <input type="checkbox"/> 20-29 | <input type="checkbox"/> 50-59 |
| <input type="checkbox"/> 30-39 | <input type="checkbox"/> 60-69 |
| <input type="checkbox"/> 40-49 | <input type="checkbox"/> 70 + |
6. How long have you been a woodworker?
- | | |
|--------------------------------------|---------------------------------------|
| <input type="checkbox"/> 0 - 2 Years | <input type="checkbox"/> 8 - 20 Years |
| <input type="checkbox"/> 2 - 8 Years | <input type="checkbox"/> 20+ Years |
7. How would you rank your woodworking skills?
- | | |
|---------------------------------------|---|
| <input type="checkbox"/> Simple | <input type="checkbox"/> Advanced |
| <input type="checkbox"/> Intermediate | <input type="checkbox"/> Master Craftsman |
8. What stationary woodworking tools do you own? Check all that apply.
- | | |
|--|--|
| <input type="checkbox"/> Air Compressor | <input type="checkbox"/> Panel Saw |
| <input type="checkbox"/> Band Saw | <input type="checkbox"/> Planer |
| <input type="checkbox"/> Drill Press | <input type="checkbox"/> Power Feeder |
| <input type="checkbox"/> Drum Sander | <input type="checkbox"/> Radial Arm Saw |
| <input type="checkbox"/> Dust Collector | <input type="checkbox"/> Shaper |
| <input type="checkbox"/> Horizontal Boring Machine | <input type="checkbox"/> Spindle Sander |
| <input type="checkbox"/> Jointer | <input type="checkbox"/> Table Saw |
| <input type="checkbox"/> Lathe | <input type="checkbox"/> Vacuum Veneer Press |
| <input type="checkbox"/> Mortiser | <input type="checkbox"/> Wide Belt Sander |
| ____ Other _____ | |
9. How many of your woodworking machines are Grizzly? _____
10. Which benchtop tools do you own? Check all that apply.
- | | |
|--|---|
| <input type="checkbox"/> 1" x 42" Belt Sander | <input type="checkbox"/> 6" - Edge Grinder |
| <input type="checkbox"/> 5" - Edge Drill Press | <input type="checkbox"/> Mini Lathe |
| <input type="checkbox"/> Edge Table Saw | <input type="checkbox"/> 10" - 12" Thickness Planer |
| <input type="checkbox"/> Edge - 10" Bandsaw | <input type="checkbox"/> Scroll Saw |
| <input type="checkbox"/> Disc/Belt Sander | <input type="checkbox"/> Spindle/Belt Sander |
| <input type="checkbox"/> Mini Jointer | |
| ____ Other _____ | |
11. How many of the machines checked above are Grizzly? _____
12. Which portable/hand held power tools do you own? Check all that apply.
- | | |
|---|--|
| <input type="checkbox"/> Belt Sander | <input type="checkbox"/> Orbital Sander |
| <input type="checkbox"/> Biscuit Joiner | <input type="checkbox"/> Palm Sander |
| <input type="checkbox"/> Circular Saw | <input type="checkbox"/> Portable Planer |
| <input type="checkbox"/> Detail Sander | <input type="checkbox"/> Saber Saw |
| <input type="checkbox"/> Drill/Driver | <input type="checkbox"/> Reciprocating Saw |
| <input type="checkbox"/> Miter Saw | <input type="checkbox"/> Router |
| ____ Other _____ | |
13. What machines/supplies would you like Grizzly Industrial to carry?

14. What new accessories would you like Grizzly Industrial to carry?

15. What other companies do you purchase your tools and supplies from?

16. Do you think your purchase represents good value?
 Yes No
17. Would you recommend Grizzly Industrial to a friend?
 Yes No
18. Would you allow us to use your name as a reference for Grizzly customers in your area? **Note: We never use names more than three times.**
 Yes No
19. Comments: _____

CUT ALONG DOTTED LINE

FOLD ALONG DOTTED LINE



Place
Stamp
Here



GRIZZLY INDUSTRIAL, INC.
P.O. BOX 2069
BELLINGHAM, WA 98227-2069



FOLD ALONG DOTTED LINE

Send a Grizzly Catalog to a friend:

Name _____
Street _____
City _____ State _____ Zip _____

TAPE ALONG EDGES--PLEASE DO NOT STAPLE

grizzly.com

TOOL WEBSITE

Buy Direct and Save with Grizzly® – Trusted, Proven and a Great Value!

Visit Our Website Today And Discover Why
Grizzly® Is The Industry Leader!

- 
- 
- 

B

A

B

G

1-800-523-4777

