

SHARP

COLOR TELEVISION

MODEL
27F541

OPERATION MANUAL



Products that have earned the ENERGY STAR® are designed to protect the environment through superior energy efficiency.

CONTENTS

	PAGE		
• IMPORTANT INFORMATION/IMPORTANT SAFEGUARDS	2-4	• Parent Control	16-26
• Supplied Accessories	5	• V-CHIP Operation	16-23
• Before Operating Your Television	5	• VIEW TIMER	24-26
• Antenna Connections	5, 6	• Energy Save	27
• Quick Reference Control Operation	7-8	• Set Up	28-34
• EZ SETUP during First Use	9	• EZ Setup	28
• Demo Mode	10	• Channel Setting	29-31
• Accessing the MAIN MENU screen without Remote Control	10	• Blue Screen	31, 32
• Language	11	• Personal Preference	33
• Sleep Timer	11	• Universal Plus Function	34
• Video Adjust	12	• Auto Input	35
• Audio Select	13	• CH/Input ID	36, 37
• MTS (Multichannel TV Sound)	13	• Using the Video and Audio Input Terminals	38-39
• SPEAKER (Internal Speaker Switch)	13	• Using the Audio Output Terminals	40
• FAO (Fixed Audio Output)	13	• Operation of Universal Remote Control	41-44
• AUDIO ADJUST	14	• Before Calling for Service	45
• Closed Caption	15	• Calling for Service	45
		• Specifications	46
		• Limited Warranty	59

This operation manual includes basic operating instructions in Spanish and French.
SPANISH is on page 47-52.
FRENCH is on page 53-58.

B225WJ

Welcome to the SHARP Family. We are pleased that you are now the owner of a SHARP Color Television – built for outstanding quality, reliability and performance.

Every SHARP Color Television set is tuned and adjusted for proper color and sound, and has passed through the most stringent quality control tests at the factory. We have prepared this OPERATION MANUAL so that you may adjust the picture and color to your personal viewing preference.

We sincerely hope that you receive the greatest satisfaction and enjoyment from your new SHARP Color Television set for years to come.

Please read these instructions carefully, and keep them handy for your future reference.

IMPORTANT

To aid reporting in case of loss or theft, please record the TV's model and serial numbers in the space provided. The numbers are located at the rear of the TV.

Model No.:

Serial No.:

IMPORTANT INFORMATION

There are two important reasons for prompt warranty registration of your new SHARP television set. Use the REGISTRATION CARD packed in with the set.

FIRST – WARRANTY

This is to assure that you will immediately receive the full consumer benefit of the parts, service and labor warranty applicable to your purchase.

SECOND – CONSUMER PRODUCT SAFETY ACT

To assure that you will promptly receive any safety notification on inspection, modification or recall that SHARP may be required to give under the 1972 Consumer Product Safety Act. PLEASE READ CAREFULLY THE IMPORTANT "LIMITED WARRANTY" CLAUSE ON THE LAST PAGE.

WARNING: TO REDUCE THE RISK OF FIRE OR ELECTRIC SHOCK, DO NOT EXPOSE THIS APPLIANCE TO WET LOCATIONS.

	CAUTION RISK OF ELECTRIC SHOCK DO NOT OPEN	
CAUTION: TO REDUCE THE RISK OF ELECTRIC SHOCK, DO NOT REMOVE COVER (OR BACK). NO USER-SERVICEABLE PARTS INSIDE. REFER SERVICING TO QUALIFIED SERVICE PERSONNEL.		



The lightning flash with arrowhead within a triangle is intended to tell the user that parts inside the product are a risk of electric shock to persons.



The exclamation point within a triangle is intended to tell the user that important operating and servicing instructions are in the papers with the appliance.

"Note to CATV system installer: This reminder is provided to call the CATV system installer's attention to Article 820-40 of the National Electrical Code that provides guidelines for proper grounding and, in particular, specifies that the cable ground shall be connected to the grounding system of the building, as close to the point of cable entry as practical."

WARNING – FCC Regulations state that any unauthorized changes or modifications to this equipment not expressly approved by the manufacturer could void the user's authority to operate this equipment.

PRODUCT DISPOSAL

This product utilizes a Cathode Ray Tube (CRT) containing lead and tin-lead solder. Disposal of these materials may be regulated due to environment considerations. For disposal or recycling information, please contact your local authorities or the Electronics Industries Alliance: www.eiae.org

IMPORTANT INFORMATION (Continued)

CAUTION:

- Do not place the AC power cord under the TV set or other heavy items.
- To prevent fire, never place any type of candle or naked flames on the top or near the TV set.
- To prevent fire or shock hazard, do not expose this products to dripping or splashing. No objects filled with liquids, such as vases, should be placed on the product.

IMPORTANT SAFEGUARDS

CAUTION: Please read all of these instructions before you operate your television and save these instructions for later use.

Electrical energy can perform many useful functions. This unit has been engineered and manufactured to assure your personal safety. BUT IMPROPER USE CAN RESULT IN POTENTIAL ELECTRICAL SHOCK OR FIRE HAZARDS. In order not to defeat the safeguards incorporated in this equipment, observe the following basic rules for its installation, use and servicing.

1. Unplug this television equipment from the wall outlet before cleaning.
2. Do not use liquid cleaners or aerosol cleaners. Use a damp cloth for cleaning.
3. Do not use attachments not recommended by the television equipment manufacturer as they may cause hazards.
4. Do not use this television equipment near water — for example, near a bath tub, washbowl, kitchen sink or laundry tub, in a wet basement, or near a swimming pool, etc.
5. Do not place this equipment on an unstable cart, stand, or table. The television equipment may fall, causing serious injury to a child or an adult, and serious damage to the equipment. Use only with a cart or stand recommended by the manufacturer or sold with the television equipment.
6. Television equipment and cart combination should be moved with care. Quick stops, excessive force, and uneven surfaces may cause the equipment and cart combination to overturn.
7. Wall or shelf mounting should follow the manufacturer's instructions, and should use a mounting kit approved by the manufacturer.
8. Slots and openings in the cabinet and the back or bottom are provided for ventilation. To insure reliable operation of the television equipment and to protect it from overheating, these openings must not be blocked or covered. This television equipment should not be placed in a built-in insulation such as a bookcase unless proper ventilation is provided.
9. The openings should never be covered with a cloth or other material, and the bottom openings should not be blocked by placing the television equipment on a bed, sofa, rug, or other similar surface. This television equipment should never be placed near or over a radiator or heat register.
10. This television equipment should be operated only from the type of power source indicated on the marking label. If you are not sure of the type of power supplied to your home, consult your television dealer or local power company.



For television equipment designed to operate from battery power, refer to the operating instructions.

11. As a safety feature, television equipment is equipped with a 2-wire polarized plug (one plug blade bigger than the other). The 2-wire polarized plug will fit only one way into the power outlet.
If the plug does not fit, ask your electrician to replace your obsolete outlet. Do not modify the plug and defeat this safety feature.
12. Do not allow anything to rest on the power cord. Do not locate this television equipment where the cord will be abused by persons walking on it.

IMPORTANT SAFEGUARDS (Continued)

13. Follow all warnings and instructions marked on the television equipment.
14. If an outside antenna is connected to the television equipment, be sure the antenna system is grounded so as to provide some protection against voltage surges and built-up static charges. Section 810 of the National Electrical Code provides information with respect to proper grounding of the mast and supporting structure, grounding of the lead-in wire to an antenna discharge unit, size of grounding conductors, location of antenna-discharge unit, connection to grounding electrodes, and requirements for the grounding electrode.

EXAMPLE OF ANTENNA GROUNDING AS PER
NATIONAL ELECTRICAL CODE

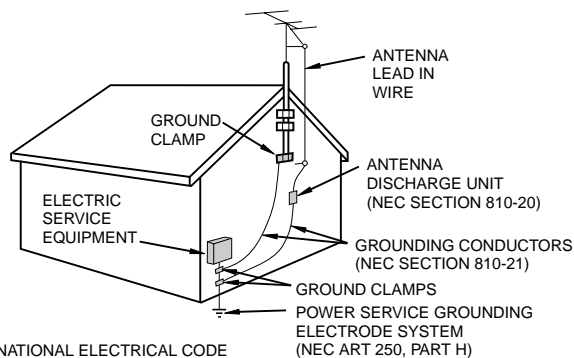

15. For added protection for this television equipment during a lightning storm, or when it is left unattended and unused for long periods of time, unplug it from the wall outlet and disconnect the antenna. This will prevent damage to the equipment due to lightning and power-line surges.
16. An outside antenna system should not be located in the vicinity of overhead power lines or other electric light or power circuits, or where it can fall into such power lines or circuits. When installing an outside antenna system, extreme care should be taken to keep from touching such power lines or circuits as contact with them might be fatal.
17. Do not overload wall outlets and extension cords as this can result in fire or electric shock.
18. Never push objects of any kind into this television equipment through cabinet slots as they may touch dangerous voltage points or short out parts that could result in a fire or electric shock. Never spill liquid of any kind on the television equipment.
19. Do not attempt to service this television equipment yourself as opening or removing covers may expose you to dangerous voltage or other hazards. Refer all servicing to qualified service personnel.
20. Unplug this television equipment from the wall outlet and refer servicing to qualified service personnel under the following conditions:
 - A. When the power cord or plug is damaged or frayed.
 - B. If liquid has been spilled into the television equipment.
 - C. If the television equipment has been exposed to rain or water.
 - D. If the television equipment does not operate normally by following the operating instructions. Adjust only those controls that are covered by the operating instructions as improper adjustment of other controls may result in damage and will often require extensive work by a qualified technician to restore the television equipment to normal operation.
 - E. If the television equipment has been dropped or the cabinet has been damaged.
 - F. When the television equipment exhibits a distinct change in performance — this indicates a need for service.
21. Upon completion of any service or repairs to this television equipment, ask the service technician to perform routine safety checks to determine that the television is in safe operating condition.
22. When replacement parts are required, be sure the service technician has used replacement parts specified by the manufacturer that have the same characteristics as the original part. Unauthorized substitutions may result in fire, electric shock, or other hazards.

Supplied Accessories

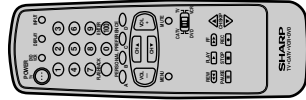

Infrared Remote Control

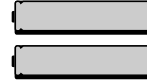

Size AA
Dry Batteries

Before Operating Your Television

Location

- For normal operation, your TV should be located in an area of the room where cool adequate ventilation is provided. Do not place the back of the television set in a place where free airflow will be restricted.
- Any magnetic force may disturb the color picture. Make sure that magnets, electric clocks, toys using magnets or any other magnetic substance, such as iron are kept well away from the TV set.

Power

Your TV operates on 120 Volts, 60 Hz (normal household current) and has a polarized plug. If you are unable to insert the plug fully into the outlet, try reversing the plug. Should it fail to fit, contact an electrician. Do not defeat the safety feature of the polarized plug.

Note:

- If the set is not going to be used for a long period, such as during a vacation, unplug the set from the wall outlet to economize power. (If the TV set is plugged in, a slight current still flows, even with the POWER BUTTON in the OFF position.)
- Lines and other noise may appear in TV broadcast images when an FM tuner or radio is located near the TV and both radio and TV broadcasts are being received. Should such noise appear, turn off the radio.
- If you are listening to an AM broadcast, turn the TV off. AM broadcast signals may not be received due to interference from the TV.
- **Before using the television, prepare the Remote Control**
To use the remote control, insert batteries first.

Inserting the batteries



- With your thumbnail, pull up the slit as indicated by the arrow to remove the battery cover. Insert two batteries (size "AA"). Be sure to match the battery \oplus/\ominus terminals with the \oplus/\ominus marks inside the compartment.

Antenna Connections

Antennas

- The antenna requirements for good color television reception are more important than those for black & white television reception. For this reason, a good quality outdoor antenna is strongly recommended.

The following is a brief explanation of the type of connections that are provided with the various antenna systems:

1. A 75-ohm system is generally a round cable with F-type connector that can easily be attached to a terminal without tools (not supplied).
2. A 300-ohm system is a flat "twin-lead" cable that can be attached to a 75-ohm terminal through a 300/75-ohm ADAPTOR (not supplied).

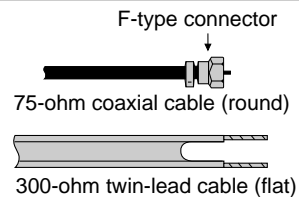

Antenna Connections (Continued)

OUTDOOR ANTENNA CONNECTION

- Refer to one of the following two diagrams when connecting to an outdoor antenna.
 - A: Using a VHF/UHF combination outdoor antenna.
 - B: Using separate VHF and/or UHF outdoor antenna.
- Connect an outdoor antenna cable lead-in to the ANT/CABLE terminal on the rear of the TV set.

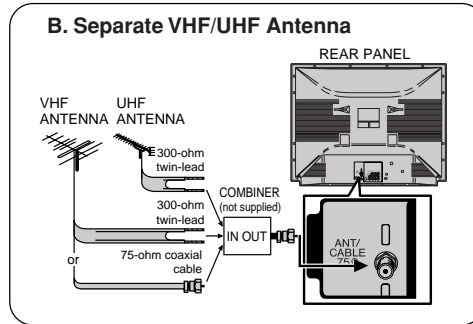
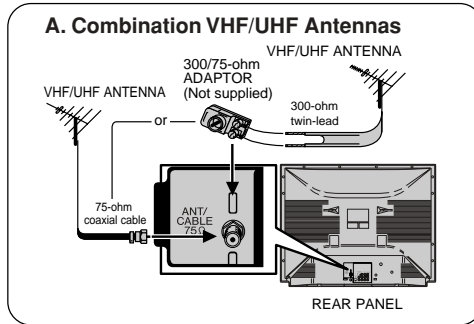

NOTICE

F-type connector should be finger-tightened only.

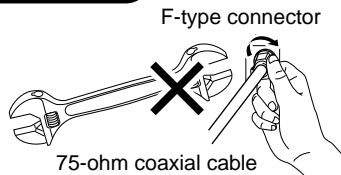

When connecting the RF cable to the TV set, do not tighten F-type connector with tools. If tools are used, it may cause damage to your TV set. (The breaking of internal circuit, etc.)

CABLE TV (CATV) CONNECTION

- A 75 ohm coaxial cable connector is built into the set for easy hookup. When connecting the 75 ohm coaxial cable to the set, screw the 75 ohm cable to the COAXIAL CABLE CONNECTOR.
- Some cable TV companies offer "premium pay channels". Since the signals of these premium pay channels are scrambled, a cable TV converter/descrambler is generally provided to the subscriber by the cable TV company. This converter/descrambler is necessary for normal viewing of the scrambled channels. (Set your TV on channel 3 or 4. Typically one of these channels is used. If this is unknown, consult your cable TV company.) For more specific instructions on installing cable TV, consult your cable TV company. One possible method of utilizing the converter/descrambler provided by your cable TV company is explained below.

Please note: RF switch equipped with position A/B (not provided) is required.

"A" position on the RF switch (not supplied) : You can view all unscrambled channels using the TV's channel keys.

"B" position on the RF switch (not supplied) : You can view the scrambled channels via the converter/descrambler using the converter's channel keys.

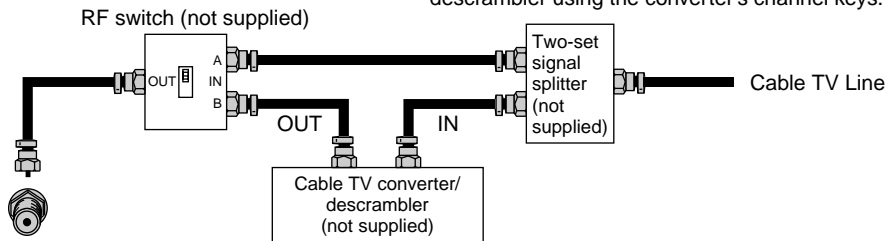

Note:

- Consult your SHARP Dealer or Service Center for the type of splitter, RF switch or combiner that might be required.

Quick Reference Control Operation

● Part Names

Front Panel

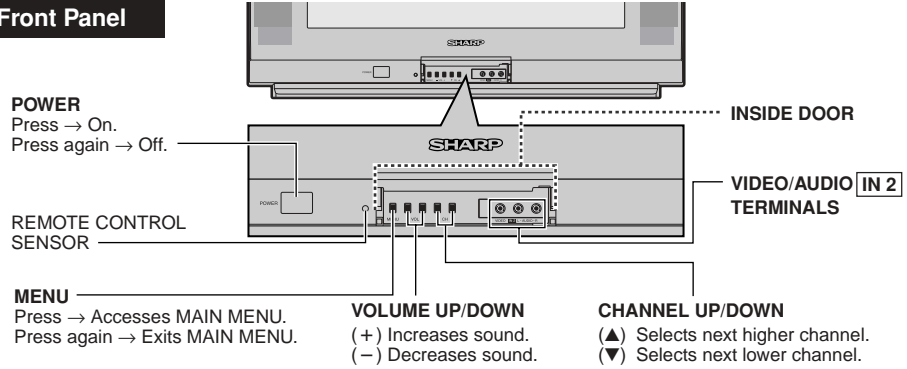

To open the door
Using the projection located under the "PULL-OPEN" indication, pull and lift the door open.



To close the door
Using the projection, lower the door until closed.

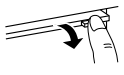

Caution:

- When opening or closing the door, do not insert your fingers into the gap between the door and front panel. This may result in an injury.

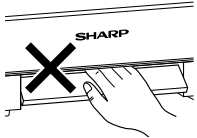

Rear Panel

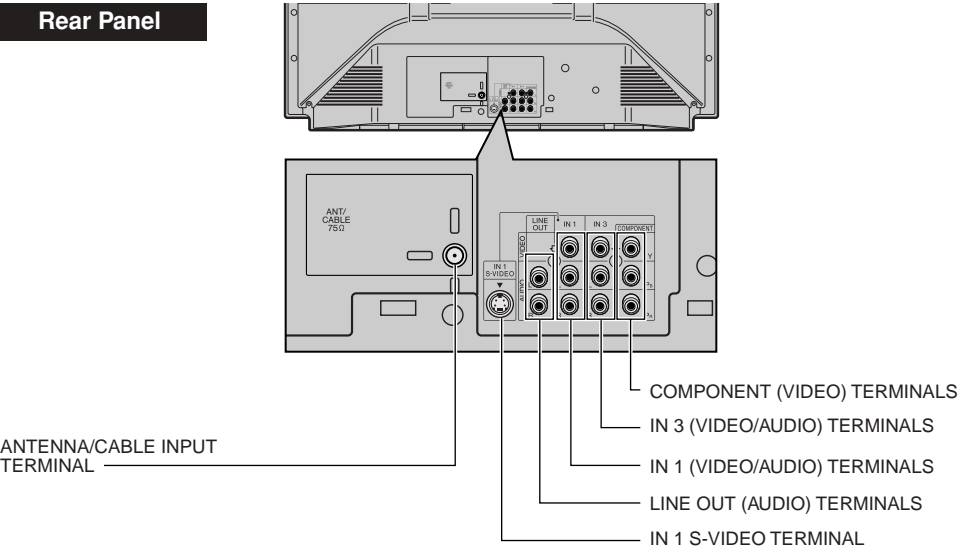

Note:

- The TV set and remote control illustrations and the on-screen displays in this manual may differ from their actual appearance.

Quick Reference Control Operation (Continued)

● Part Names

Basic Remote Control Functions

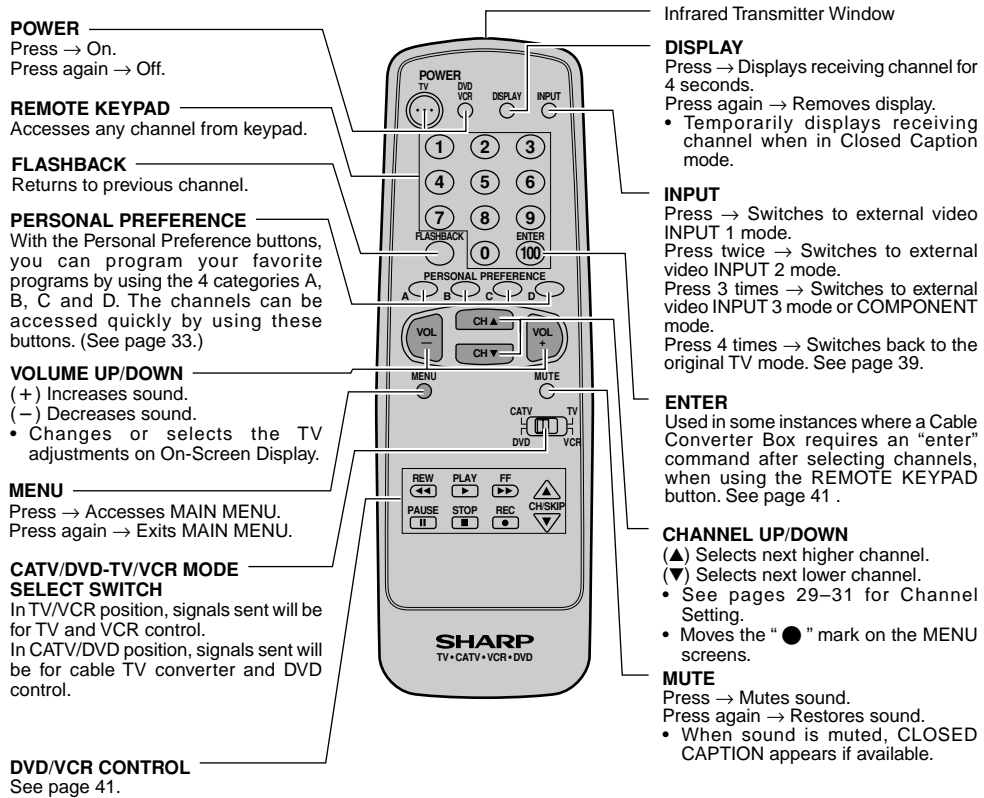

Note:

- The above shaded buttons on the Remote Control glow in the dark. To use the glow-in-the-dark display on the remote control, place it under a fluorescent light or other lighting.
- The phosphorescent material contains no radioactive or toxic material, so it is safe to use.
- The degree of illumination will vary depending on the strength of lighting used.
- The degree of illumination will decrease with time and depending on the temperature.
- The time needed to charge the phosphorescent display will vary depending on the surrounding lighting.
- Sunlight and fluorescent lighting are the most effective when charging the display.
- The TV set and remote control illustrations and the on-screen displays in this manual may differ from their actual appearance.

EZ SETUP during First Use

- When you turn on the TV for the first time, it will automatically memorize the broadcasting channels. Please perform the following instructions before pressing the **POWER** button.
 - Insert the batteries into the remote control. (See page 5)
 - Connect the antenna cable to the TV set. (See pages 5, 6)
 - Plug in the **AC POWER** cord to the wall outlet.

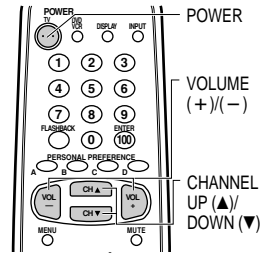

- Press the **POWER** button on the TV set or on the Remote Control to turn on the TV. The **SELECT LANGUAGE** screen will be displayed.

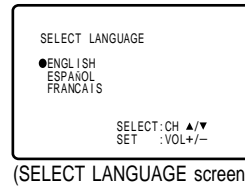
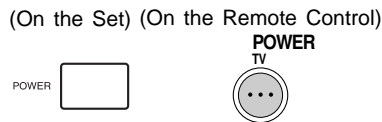

- Press **CH ▲/▼** to select "ENGLISH", "ESPAÑOL (SPANISH)" or "FRANCAIS (FRENCH)".

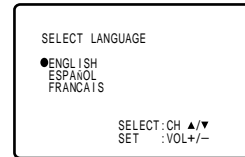

- Press **VOL +/-** to access the **EZ SETUP** screen.

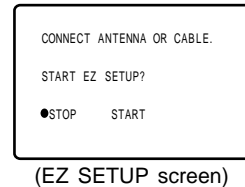
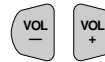

- Press **VOL +**. The tuner will automatically search for the broadcasting and cable TV channels. (The CH No. will automatically increase when it appears.)
If you want to stop the **EZ SETUP** process once it has started, press **VOL -** and it will be canceled.
If you want to **SET UP** again, please refer to page 28 on **SET UP**.

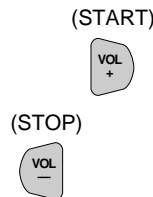

To cancel EZ SETUP
Press **VOL -**.

- Once **EZ SETUP** is complete, the lowest channel number memorized will be displayed.



Note:

- If **EZ SETUP** does not memorize all the channels in your region, please refer to pages 29–31 for more information on manually memorizing the channels using **CHANNEL SETTING**.
- It may be difficult to **PRESET** when the broadcast signals are weak, the channel cycle frequency is incorrect or frequency jamming is occurring around the area. Please refer to pages 29–31 for more information on manually memorizing the channels using **CHANNEL SETTING**.

Demo Mode

- To learn more about the TV set, you can enter DEMO mode. Simply press and hold **MENU** on the TV set for more than 3 seconds.
- To cancel DEMO mode, again press **MENU** on the TV set for more than 3 seconds.

Example:
DEMO mode display



(On the Set)

MENU



MENU

MENU
button

Accessing the MAIN MENU screen without Remote Control

- If you misplaced your Remote Control you can still access most settings via the MAIN MENU screen by pressing **MENU** on the TV set.
- Some features of your TV set are not accessible without the Remote Control. If you lost your Remote Control, contact a Sharp Service Center for a replacement.

(On the Set)



MENU

MENU
button

Language

- The language for the ON SCREEN DISPLAY can be set to **ENGLISH, SPANISH** or **FRENCH**.

1 Press **MENU** to access the MAIN MENU screen.

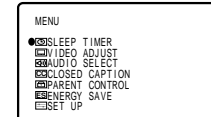

(MAIN MENU screen)

2 Press **CH ▲/▼** to move the “●” mark to “SET UP”.

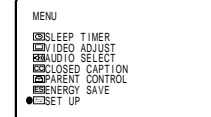

3 Press **VOL +/-** to access the SET UP screen, then press **CH ▲/▼** to move the “●” mark to “LANGUAGE”.

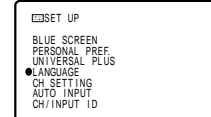
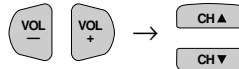

(SET UP screen)

4 Press **VOL +/-** to access the LANGUAGE select screen.

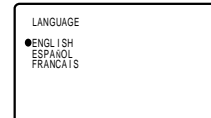
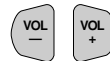

(LANGUAGE select screen)

5 Press **CH ▲/▼** to select “ENGLISH”, “ESPAÑOL (SPANISH)” or “FRANCAIS (FRENCH)”.

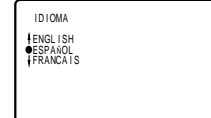

6 Press **MENU** to exit.



Sleep Timer

- You can preset your television to turn off automatically in increments of 30, 60, 90 or 120 minutes.

1 Press **MENU** to access the MAIN MENU screen.

2 Press **VOL +/-** to access the SLEEP TIMER screen.

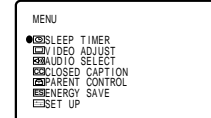
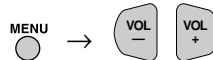

3 Press **VOL +/-** to set a sleep time of 30, 60, 90 or 120 minutes.

4 Press **MENU** to exit.



(SLEEP TIMER screen)

Note:

- To turn off the SLEEP TIMER, repeat the above SLEEP TIMER steps and select “--- M REMAIN” during step 3.
- While SLEEP TIMER is active, the time remaining will be briefly displayed on-screen at regular intervals or when the Remote’s **DISPLAY** key is pressed twice. 5 minutes before the SLEEP TIMER turns off the TV, the screen prompts the time remaining for 4 seconds. The SLEEP TIMER shows a similar display for each remaining minute and a 10-second display right before shutting off the TV.
- If you turn the POWER OFF, the SLEEP TIMER will automatically reset.

Video Adjust

Description of Adjustment Items

Selected item	VOL + button	VOL - button
PICTURE	To increase contrast	To decrease contrast
TINT	To make skin tones greenish	To make skin tones purplish
COLOR	To increase color intensity	To decrease color intensity
BRIGHT	To increase brightness	To decrease brightness
SHARP	To increase sharpness	To decrease sharpness
COLOR TEMP.	To choose a LOW, ML, MH or HIGH color tone.	
RESET	To return all adjustments to factory preset levels.	

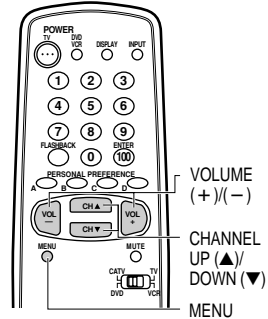

- 1 Press **MENU** to access the MAIN MENU screen.
- 2 Press **CH ▲/▼** to move the “●” mark to “VIDEO ADJUST”.

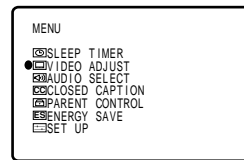
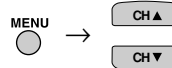

(MAIN MENU screen)

- 3 Press **VOL +/-** to access the PICTURE adjust screen.

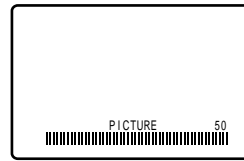
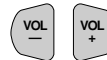

(PICTURE adjust screen)

- 4 Press **CH ▲/▼** to select the desired adjustment item. (Refer to the diagram below.)

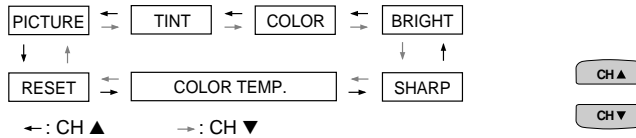

- 5 Press **VOL +/-** to adjust the setting.

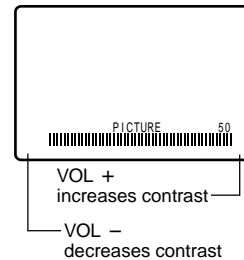
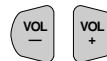

- 6 Repeat steps 4 to 5 to adjust other settings.

- 7 Press **MENU** to exit.



Note:

- VIDEO ADJUST setting, once set, is shared among AIR/CABLE, INPUT 1, INPUT 2, and INPUT 3 modes.
- VIDEO ADJUST setting for INPUT 3 when used as COMPONENT can be set independently.

Audio Select

■ MTS (Multichannel TV Sound)

This function allows reception of stereo or bilingual TV sound.

- You can enjoy Hi-Fi stereo sound or SAP broadcasts where available.

Stereo broadcasts

Live television broadcasts of sports, shows, concerts, etc. can be received in dynamic stereo sound.

SAP broadcasts

Television broadcast can be received with either MAIN or SAP sound.

MAIN sound: The normal program soundtrack. (Monaural or stereo where available.)

SAP sound: Second language, supplementary commentaries, etc. (SAP sound is monaural.)

- If stereo sound is difficult to hear;

You can obtain clearer sound by manually switching to fixed monaural mode.

■ SPEAKER (Internal Speaker Switch)

This function turns the TV's internal speakers "ON" or "OFF" when listening to sound from external speakers by using the AUDIO OUTPUT Terminals. (See page 40).

■ FAO (Fixed Audio Output)

This function turns the TV's internal speakers "OFF" and allows fixed audio output from the AUDIO OUTPUT Terminals. (See page 40). With FAO, the TV's volume control is disabled.

- 1 Press **MENU** to access the MAIN MENU screen.

- 2 Press **CH ▲/▼** to move the "●" mark to "AUDIO SELECT".

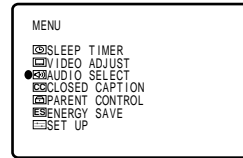
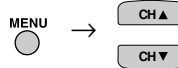

(MAIN MENU screen)

- 3 Press **VOL +/-** to access the AUDIO SELECT screen.

- 4 Press **CH ▲/▼** to move the "●" mark to "MTS", "SPEAKER", "FAO" or "AUDIO ADJUST".

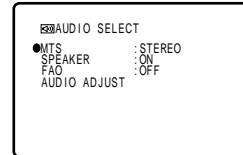
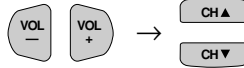

(AUDIO SELECT screen)

- 5 Press **VOL +/-** to select "STEREO", "SAP" or "MONO" when the "●" mark is at "MTS" position.

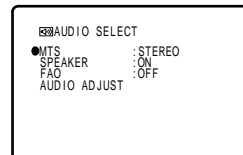
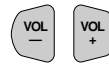
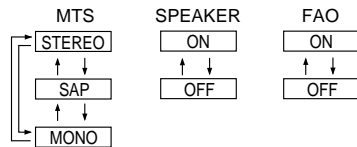

(AUDIO SELECT screen)

Audio Select (Continued)

AUDIO ADJUST

When the "●" mark is at "AUDIO ADJUST", press **VOL +/-** to access the AUDIO ADJUST screen. To access the desired item, press **CH ▲/▼**. To adjust the audio setting, press **VOL +/-**.

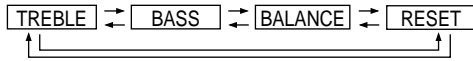

Selected item	VOL + button	VOL - button
TREBLE	To increase treble response.	To decrease treble response.
BASS	To increase bass response.	To decrease bass response.
BALANCE	To emphasize the right speaker's volume.	To emphasize the left speaker's volume.
RESET	To return all adjustments to factory preset levels.	

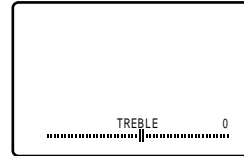

6 Press **MENU** to exit.



An example screen displaying ON AIR when receiving stereo broadcasts

Current channel number

"← ON AIR" will appear next to STEREO or SAP when receiving STEREO or SAP broadcasts.

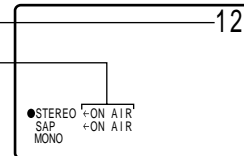

(CHANNEL call on screen)

Note:

- Once MONO mode is selected, the TV sound remains monaural even if the TV set receives a stereo broadcast. You must switch the mode back to STEREO if you want to hear stereo sound again.
- Selecting MTS while receiving video signals from INPUT terminals does not change the type of sound; in this case, sound is determined by the video source.
- If "FAO" mode is on, "SPEAKER" mode will automatically turn off. Changing "SPEAKER" setting will not affect "FAO" mode.

Closed Caption

How to set CLOSED CAPTION

- Your TV is equipped with an internal Closed Caption decoder. "Closed Caption" is a system which allows conversations, narration, and sound effects in TV programs and home videos to appear as captions on the TV screen (see the illustration).
- Not all the programs and videos will offer closed captioning. Please look for the "CC" symbol to ensure that captions will be shown.
- Closed Caption broadcast can be viewed in two modes: CAPTION and TEXT. For each mode, two channels are available, CH1 and CH2. The CAPTION mode shows subtitles of dialogs and commentaries of TV dramas and news programs while allowing clear view of the picture. The TEXT mode displays over the picture other various information (such as TV program schedule, weather forecast, etc.) that is independent of the TV programs.

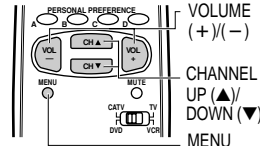

- Press **MENU** to access the MAIN MENU screen.
- Press **CH ▲/▼** to move the "●" mark to "CLOSED CAPTION".

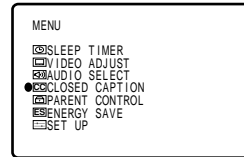
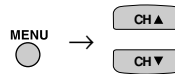

(MAIN MENU screen)

- Press **VOL +/-** to access the CLOSED CAPTION setting screen.

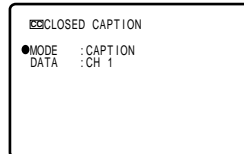
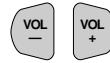

(CLOSED CAPTION setting screen)

- Press **CH ▲/▼** to move the "●" mark to either "MODE" or "DATA".

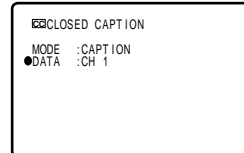

- Press **VOL +/-** to change the CLOSED CAPTION setting.

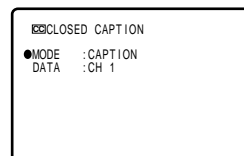
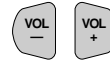
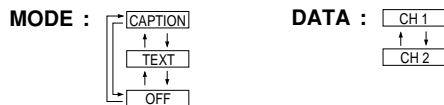

- Press **MENU** to exit.



Note:

- If a broadcast contains CLOSED CAPTION and the **MUTE** button is pressed, the set enters CAPTION mode automatically. Pressing **MUTE** again will return the set to its previous condition.
- Closed Caption may malfunction (white blocks, strange characters, etc.) if signal conditions are poor or if there are problems at the broadcast source. This does not necessarily indicate a problem with your TV.
- If any button is pressed to call up the ON SCREEN DISPLAY while viewing a CLOSED CAPTION broadcast, the closed captions will disappear momentarily.
- If no TEXT broadcast is being received while viewing in the TEXT mode, the screen may become dark and blank for some programs. Should this occur, switch the Closed Caption mode to "OFF".

Parent Control (V-CHIP Operation)

■ V-CHIP

- This function allows you to restrict TV programs and also allows you to control TV usage based on FCC data. This function is to prevent your children from watching violence or sexual scenes that may be harmful.
- Restriction of TV programs includes two characters that contain information about the program's MPAA rating and the TV Parental Guidelines. MPAA is restricted by age. TV Parental Guidelines are restricted by age and contents.
- Since a TV program may use either the MPAA rating or the TV Guidelines you should adjust both for complete control.

[1] MPAA RATING

RATING		
age based	G	GENERAL AUDIENCES. All ages admitted.
	PG	PARENTAL GUIDANCE SUGGESTED. Some material may not be suitable for children.
	PG-13	PARENTS STRONGLY CAUTIONED. Some material may be inappropriate for children under 13.
	R	RESTRICTED. Under 17 requires accompanying parent or adult guardian.
	NC-17	NO ONE 17 AND UNDER ADMITTED.
	X	X Rating is an older rating that is unified with NC-17 but may be encoded on older movie's data.

• MPAA RATING

Example 1:

"PG-13" in the age-based rating is blocked, this will automatically block the higher ratings "R", "NC-17", "X" also.

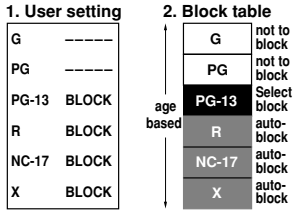

Example 2:

"R" in the age-based rating is blocked, this will automatically block the higher rating "NC-17", "X" also.

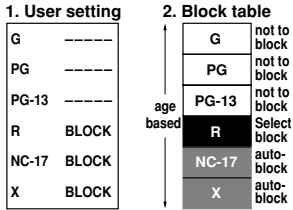

Note:

- MPAA RATING is only age-based.

[2] TV PARENTAL GUIDELINES

RATING		⇔ content based ⇔					
		AGE	D (Sexually Suggestive Dialog)	L (Adult Language)	S (Sexual Situation)	V (Violence)	FV (Fantasy Violence)
↑ age based ↓	TV-Y (All children)	<input checked="" type="checkbox"/>	-	-	-	-	-
	TV-Y7 (Direct to Older Children)	<input checked="" type="checkbox"/>	-	-	-	-	<input checked="" type="checkbox"/>
	TV-G (General Audience)	<input checked="" type="checkbox"/>	-	-	-	-	-
	TV-PG (Parental Guidance Suggested)	<input checked="" type="checkbox"/>	<input checked="" type="checkbox"/>	<input checked="" type="checkbox"/>	<input checked="" type="checkbox"/>	<input checked="" type="checkbox"/>	-
	TV-14 (Parents Strongly Cautioned)	<input checked="" type="checkbox"/>	<input checked="" type="checkbox"/>	<input checked="" type="checkbox"/>	<input checked="" type="checkbox"/>	<input checked="" type="checkbox"/>	-
	TV-MA (Mature Audience Only)	<input checked="" type="checkbox"/>	-	<input checked="" type="checkbox"/>	<input checked="" type="checkbox"/>	<input checked="" type="checkbox"/>	-

- : Content Rating can be set.
- : Content Rating cannot be set (not normally broadcast by TV station).

Parent Control (V-CHIP Operation) (Continued)

• **TV PARENTAL GUIDELINES (Example)**

Example 1.1 : Age Based setting

Clear s (block) from each "AGE" box for all ratings.
This will automatically unblock everything.

	AGE	D	L	S	V	FV	
TV-Y	<input type="checkbox"/>	-	-	-	-	-	<input type="checkbox"/> VIEW
TV-Y7	<input type="checkbox"/>	-	-	-	-	-	<input checked="" type="checkbox"/> BLOCK
TV-G	<input type="checkbox"/>	-	-	-	-	-	
TV-PG	<input type="checkbox"/>	-	-	-	-	-	
TV-14	<input type="checkbox"/>	-	-	-	-	-	
TV-MA	<input type="checkbox"/>	-	-	-	-	-	
MENU: RETURN							

Example 1.2 : Age Based setting

For "TV-G" put a in the "AGE" box. This will automatically block the higher age ratings "TV-PG", "TV-14" and "TV-MA" as well as "TV-G". Please note the content ratings "D", "L", "S", "V" are automatically blocked as well.

	AGE	D	L	S	V	FV	
TV-Y	<input type="checkbox"/>	-	-	-	-	-	<input type="checkbox"/> VIEW
TV-Y7	<input type="checkbox"/>	-	-	-	-	-	<input checked="" type="checkbox"/> BLOCK
TV-G	<input checked="" type="checkbox"/>	-	-	-	-	-	
TV-PG	<input checked="" type="checkbox"/>	<input checked="" type="checkbox"/>	<input checked="" type="checkbox"/>	<input checked="" type="checkbox"/>	<input checked="" type="checkbox"/>	<input checked="" type="checkbox"/>	
TV-14	<input checked="" type="checkbox"/>	<input checked="" type="checkbox"/>	<input checked="" type="checkbox"/>	<input checked="" type="checkbox"/>	<input checked="" type="checkbox"/>	<input checked="" type="checkbox"/>	
TV-MA	<input checked="" type="checkbox"/>	<input checked="" type="checkbox"/>	<input checked="" type="checkbox"/>	<input checked="" type="checkbox"/>	<input checked="" type="checkbox"/>	<input checked="" type="checkbox"/>	
MENU: RETURN							

Example 2.1 : Content Based setting

If you choose to unblock every content-based items ("D", "L", "S", "V"), clear the (block) from each "AGE" box of "TV-PG", "TV-14" and "TV-MA".

	AGE	D	L	S	V	FV	
TV-Y	<input type="checkbox"/>	-	-	-	-	-	<input type="checkbox"/> VIEW
TV-Y7	<input type="checkbox"/>	-	-	-	-	-	<input checked="" type="checkbox"/> BLOCK
TV-G	<input type="checkbox"/>	-	-	-	-	-	
TV-PG	<input checked="" type="checkbox"/>	-	-	-	-	-	
TV-14	<input checked="" type="checkbox"/>	-	-	-	-	-	
TV-MA	<input checked="" type="checkbox"/>	-	-	-	-	-	
MENU: RETURN							

Example 2.2 : Content Based setting

Put a in the box corresponding to "TV-PG" (row) and "V (Violence)" (column). This will automatically block the "V" boxes for "TV-14" and "TV-MA". Setting only "TV-PG-V", "TV-14-V" or "TV-MA-V" will not block all programs rated "TV-PG", "TV-14" or "TV-MA".

	AGE	D	L	S	V	FV	
TV-Y	<input type="checkbox"/>	-	-	-	-	-	<input type="checkbox"/> VIEW
TV-Y7	<input type="checkbox"/>	-	-	-	-	-	<input checked="" type="checkbox"/> BLOCK
TV-G	<input type="checkbox"/>	-	-	-	-	-	
TV-PG	<input checked="" type="checkbox"/>	-	-	-	<input checked="" type="checkbox"/>	-	
TV-14	<input type="checkbox"/>	-	-	-	<input checked="" type="checkbox"/>	-	
TV-MA	<input type="checkbox"/>	-	-	-	<input checked="" type="checkbox"/>	-	
MENU: RETURN							

Example 3 : Resetting an Age Based setting

For "TV-14", put a (block) in the "AGE" box. This will again automatically block the content ratings "D", "L", "S", "V" for "TV-MA" as well as "TV-14" ("D" is not available for "TV-MA"). Please note that the lower age rating "TV-PG" does not change from its previous settings after this.

	AGE	D	L	S	V	FV	
TV-Y	<input type="checkbox"/>	-	-	-	-	-	<input type="checkbox"/> VIEW
TV-Y7	<input type="checkbox"/>	-	-	-	-	-	<input checked="" type="checkbox"/> BLOCK
TV-G	<input type="checkbox"/>	-	-	-	-	-	
TV-PG	<input type="checkbox"/>	-	-	-	-	-	
TV-14	<input checked="" type="checkbox"/>	<input checked="" type="checkbox"/>	<input checked="" type="checkbox"/>	<input checked="" type="checkbox"/>	<input checked="" type="checkbox"/>	<input checked="" type="checkbox"/>	
TV-MA	<input type="checkbox"/>	<input checked="" type="checkbox"/>	<input checked="" type="checkbox"/>	<input checked="" type="checkbox"/>	<input checked="" type="checkbox"/>	<input checked="" type="checkbox"/>	
MENU: RETURN							

Note:

- Content ratings can be modified but only in the combinations indicated by in the table on page 16.
- Changing a lower age rating's content setting to "BLOCK" automatically changes the same higher age rating's content setting to "BLOCK" regardless of their previous settings.
- Changing a lower rating's "AGE" setting to "BLOCK" automatically changes all higher ratings to "BLOCK" regardless of their previous settings.
- For "TV-Y7", "TV-PG", "TV-14" and "TV-MA", if you clear the in the "AGE" box (unblock) you can still change settings based on content.
- Clearing a higher rating's age or content setting will not clear lower settings. Make sure that all undesired boxes are blocked.

[3] ADDITIONAL MODE

Besides "MPAA RATINGS" and "TV PARENTAL GUIDELINES", new ratings system's data can be downloaded when they become available. (See page 20.)

Parent Control (V-CHIP Operation) (Continued)

• How to set V-CHIP

[1] MPAA RATING

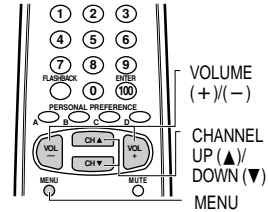

- 1 Press **MENU** to access the MAIN MENU screen.

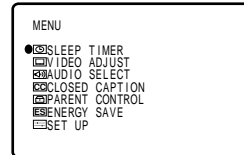

(MAIN MENU screen)

- 2 Press **CH ▲/▼** to move the “●” mark to “PARENT CONTROL”.

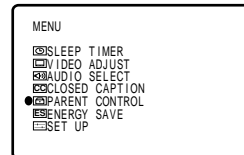

- 3 Press **VOL +/-** to access the PARENT CONTROL screen.

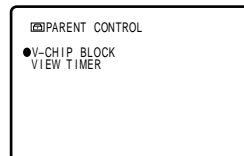
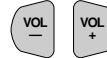

(PARENT CONTROL screen)

- 4 Press **VOL +/-** to access the V-CHIP select screen.

Note: →

- If SECRET No. is already set, enter the SECRET No. (See • **To change the V-CHIP BLOCK after registering a secret No.** on page 22.).

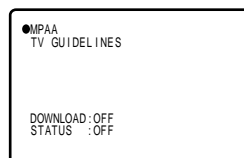
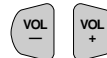

(V-CHIP select screen)

- 5 Press **VOL +/-** to select “MPAA”. Press **CH ▲/▼** to move the “●” mark to “PG”, then press **VOL +/-** to select BLOCK. If you set “PG” to BLOCK, “PG-13”, “R”, “NC-17” and “X” are automatically blocked.

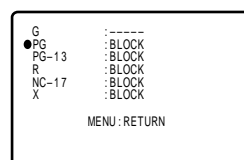
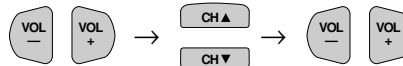

- 6 Press **MENU** to return to the V-CHIP select screen.



Parent Control (V-CHIP Operation) (Continued)

7 Press **MENU**, then "INPUT SECRET No." will be displayed.

Note:

- If SECRET No. is already set, skip to step 9.



8 Enter a 4-digit SECRET No. using the **REMOTE KEYPAD**.

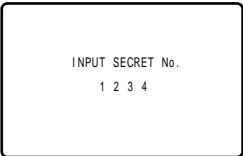

9 When done, press **MENU** to exit.



Note:

- If you set "G" to BLOCK, all ratings are automatically blocked.
- If you set "X" to BLOCK, "G", "PG", "PG-13", "R" and "NC-17" are not blocked.

[2] TV GUIDELINES

1 Repeat steps 1 to 4 of **[1] MPAA RATING**.

2 Press **CH ▲/▼** to move the "●" mark to "TV GUIDELINES".



(V-CHIP select screen)

3 Press **VOL +/-** to access the TV GUIDELINES screen.



4 To change AGE and CONTENT SETTING, press **CH ▲/▼** to move the "●" mark to the desired rating and then press **VOL +/-** to select.

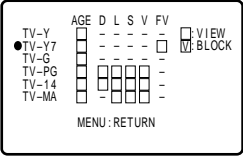
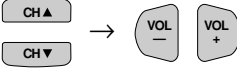

(TV GUIDELINES screen)

5 Press **CH ▲/▼** to move the "●" mark to the desired content item and then press **VOL +/-** to select either "BLOCK" or "- - - - -" (unlock).

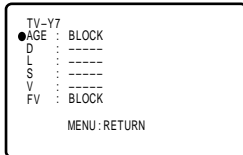
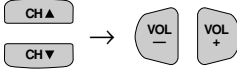

(CONTENT RATING screen)

6 Press **MENU** to return to the TV GUIDELINES screen.

7 Repeat steps 4 to 6 until all ratings and their contents are set.

8 When done, press **MENU** to return to V-CHIP select screen.

9 Press **MENU** to exit.

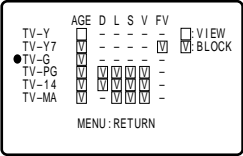

Note:

- If SECRET No. is not set, enter a SECRET No. as show in steps 7 and 8 of **[1] MPAA RATING**.

Parent Control (V-CHIP Operation) (Continued)

- [3] **Downloading additional rating mode**
 There will be an additional new rating system. In that case, please set up as follows. Subsequently the new rating system will set up automatically.

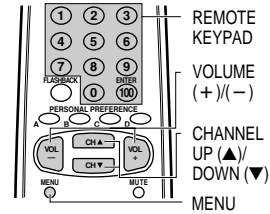

- Repeat steps 1 to 4 of [1] **MPAA RATING**.
- Press **CH ▲/▼** to move the "●" mark to "DOWNLOAD".

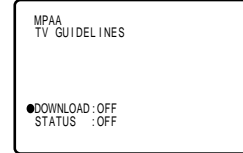

- Press **VOL +/-** to select "DOWNLOAD : ON".

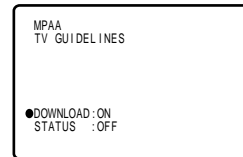
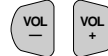

- Press **MENU**, then "INPUT SECRET No." will be displayed.

Note:

- If SECRET No. is already set, skip to step 6.

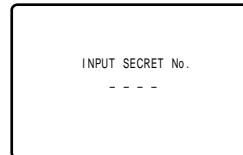

- Enter a 4-digit secret No. using the **REMOTE KEYPAD**.

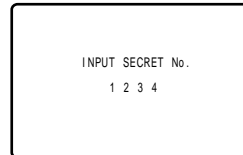
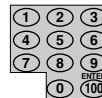

- Press **MENU** to exit.



• **Downloading V-CHIP data**

- If you watch a program containing "new rating system data", the DOWNLOAD screen will be displayed.



(DOWNLOAD screen)

- The DOWNLOAD screen will disappear, once downloading is finished.

Note:

- DOWNLOAD will not start, if you are not watching a program containing "new rating system data".

Parent Control (V-CHIP Operation) (Continued)

- **How to set additional rating mode (Example)**
Once downloading is complete, you can set the blocking pattern as follows.

- 1 Repeat steps 1 to 4 of [1] MPAA RATING.
- 2 Press **CH ▲/▼** to move the "●" mark to "Cdn. English Ratings", then press **VOL +/-**.

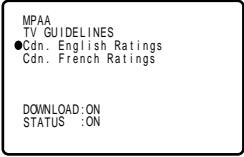
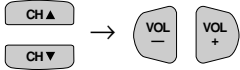

(After downloading the rating data)

- 3 You can select "BLOCK" or "-----" (unblock) for each rating item by pressing **CH ▲/▼** and **VOL +/-**.

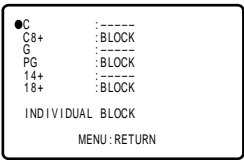
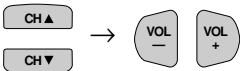

(ENGLISH INDIVIDUAL BLOCK screen)

- 4 You can select "BLOCK" or "-----" (unblock) for each rating item by pressing **CH ▲/▼** and **VOL +/-** if you select "Cdn. French Ratings" in step 2.

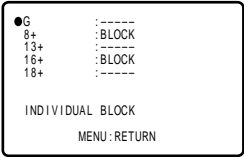
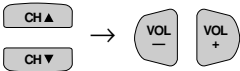

(FRENCH INDIVIDUAL BLOCK screen)

Note: ➤

- You are able to download up to 4 different rating systems.

Parent Control (V-CHIP Operation) (Continued)

• Activating the V-CHIP BLOCK

1 Repeat steps 1 to 4 of [1] MPAA RATING.

2 Press **CH ▲/▼** to move the "●" mark to "STATUS". Press **VOL +/–** to activate the V-CHIP BLOCK. (If STATUS is OFF, V-CHIP BLOCK will not operate.)

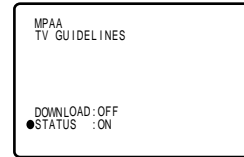
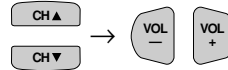

(V-CHIP select screen)

3 Press **MENU**, then "INPUT SECRET No." will be displayed.

Note:

- If SECRET No. is already set, skip to step 5.

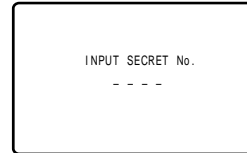

4 Enter a 4-digit secret No. using the **REMOTE KEYPAD**.

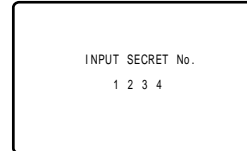

5 Press **MENU** and the secret No. will be registered.



• To temporarily cancel the V-CHIP BLOCK

1 "V-CHIP HAS BEEN ACTIVATED" appears if you view a program with the same program rating data you configured.

Note:

- "V-CHIP HAS BEEN ACTIVATED" will not be displayed if STATUS is not configured to "ON".

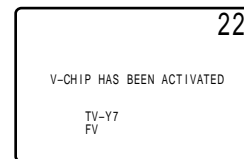

2 Press **MENU**, then "INPUT SECRET No." will be displayed.

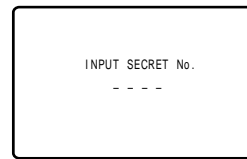

3 Enter the 4-digit secret No. using the **REMOTE KEYPAD**, then V-CHIP BLOCK will be canceled temporarily. If the wrong secret No. is chosen, "SECRET No. IS INCORRECT" will be displayed. Input the secret No. again in this case.

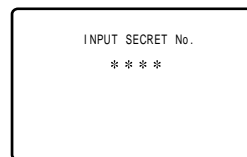

Note:

- If you turn the power ON from OFF, the V-CHIP BLOCK will be activated again.

Parent Control (V-CHIP Operation) (Continued)

● To change the V-CHIP BLOCK after registering a secret No.

- 1 Repeat steps 1 to 4 of [1] MPAA RATING, then "INPUT SECRET No." will be displayed.

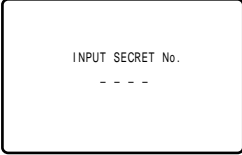

- 2 Enter the 4-digit secret No. using the **REMOTE KEYPAD** and the V-CHIP select screen will be displayed. Set V-CHIP BLOCK again.

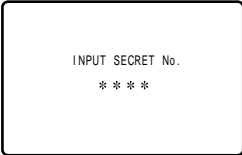

● If you forget or need to change your secret No., clear the original secret No. and set up a new one.

- 1 Repeat steps 1 to 4 of [1] MPAA RATING, or 1 to 2 of To temporarily cancel the V-CHIP BLOCK, then "INPUT SECRET No." will be displayed.

- 2 Press and hold both **VOL +** and **CH ▲** on the TV set simultaneously until the message "INPUT SECRET No." disappears.

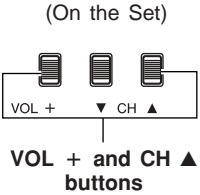

- 3 Press the **MENU** button twice to exit.



Parent Control (VIEW TIMER)

VIEW TIMER

This function allows you to restrict TV viewing time and also allows you to control TV usage. This function is to prevent your children from watching too much TV.

VIEWING TIME (an accumulative timer: counts only the time duration while the TV power is on.)

- VIEWING TIME can be set from 30M (30 minutes) to 10H00M (10 hours) in 30 minutes intervals.

OFF TIME (Restricts TV viewing after the VIEWING TIME reaches zero.)

- OFF TIME can be set from 30M (30 minutes) to 10H00M (10 hours) in 30 minutes intervals.

STATUS (Select ON to activate VIEW TIMER)

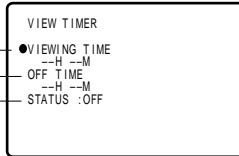

How to set VIEW TIMER

1 Press **MENU** to access the MAIN MENU screen.

2 Press **CH ▲/▼** to move the "●" mark to "PARENT CONTROL".

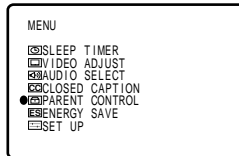
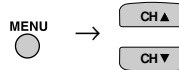

(MAIN MENU screen)

3 Press **VOL +/-** to access the PARENT CONTROL screen.

4 Press **CH ▲/▼** to move the "●" mark to "VIEW TIMER".

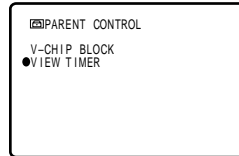
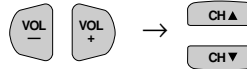

(PARENT CONTROL screen)

5 Press **VOL +/-** to access "VIEW TIMER".

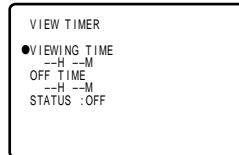

6 Press **CH ▲/▼** to select "VIEWING TIME" and "OFF TIME". For each selection, press the **VOL +/-** to set the time duration.

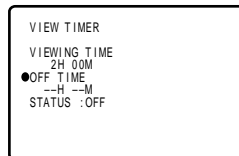
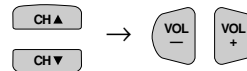

7 Press **CH ▲/▼** to select "STATUS". Press the **VOL +/-** to turn ON the "VIEW TIMER". (If STATUS is OFF, VIEW TIMER will not operate.)

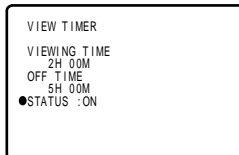
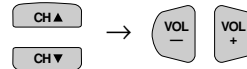

8 Press **MENU**. "INPUT SECRET No." will be displayed.

Note:

- If SECRET No. is already set, skip to step 10.

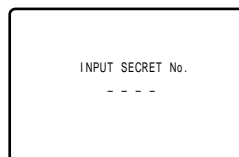

Parent Control (VIEW TIMER) (Continued)

9 Enter a 4-digit SECRET No. using the **REMOTE KEYPAD**.

10 Press **MENU** to exit.

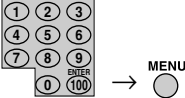

Example:

- To restrict anybody from watching TV for more than 5 hours, after watching the TV for 2 hours, your settings would look like the one on the right.
- You can choose to watch the 2 hours of TV as you wish. For example, you could watch 1 hour of TV, turn the TV off for 30 minutes, then turn the TV on and watch the remaining 1 hour of the VIEWING TIME.

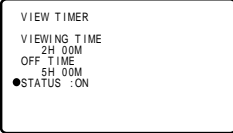

To change the VIEW TIMER setting after registering a secret No.

1 Repeat steps 1 to 4 of **How to set VIEW TIMER**. Press **VOL +/-**, and "INPUT SECRET No." will be displayed.

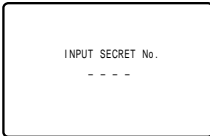
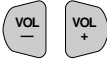

2 Enter the 4-digit SECRET No. using the **REMOTE KEYPAD**, and the VIEW TIMER access screen will be displayed. Repeat steps **5, 6**.



Note:

- When you choose the correct secret No., the VIEW TIMER access screen is displayed. If the wrong secret No. is chosen, "SECRET No. IS INCORRECT" is displayed. Input the secret No. again in this case.

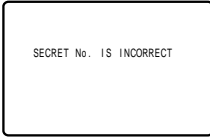

To cancel the VIEW TIMER (While the TV set is OFF but the VIEW TIMER is set.)

1 Turn on the TV; a blue screen message "TIME OVER" will appear. If you do nothing, the TV will turn off in approximately 30 seconds.

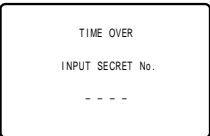

2 Enter the 4-digit secret No. using the **REMOTE KEYPAD**. When you choose the correct secret No., the VIEW TIMER is canceled. If the wrong secret No. is chosen, "SECRET No. IS INCORRECT" is displayed. Input the secret No. again in this case.



Parent Control (VIEW TIMER) (Continued)

- To cancel the VIEW TIMER setting or change the secret No. (If you forget the SECRET No.)

1 Repeat steps 1 to 4 of **How to set VIEWTIMER**. Press **VOL +/-**, and "INPUT SECRET No." will be displayed.

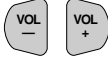

2 Press and hold both **VOL +** and **CH ▲** on the TV set simultaneously until the VIEW TIMER access screen is displayed. Now you can cancel the VIEW TIMER settings or change the SECRET No. while "INPUT SECRET No." is displayed.

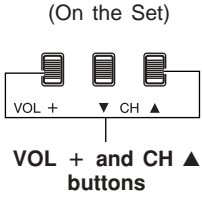

- Notice of Remaining VIEWING TIME**
 - For every 30 minute interval, the remaining time will be displayed for 4 seconds. For the last 5 minutes, the remaining time will be displayed every minute.
 - "0 REMAIN" will be displayed for 10 seconds just before the VIEWING TIME expires.

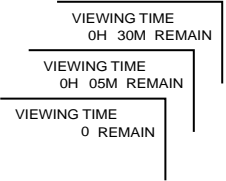

Energy Save

- This feature lets you lower the power consumption of your TV set which in turn saves you money and minimizes the impact on the environment. When this feature is turned on, it reduces the brightness of the TV to a level that consumes approximately 20 percent less energy than when the feature is turned off. The reduction in brightness will be less noticeable under low room lighting conditions.

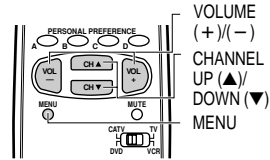

- Press **MENU** to access the MAIN MENU screen.
- Press **CH ▲/▼** to move the "●" mark to "ENERGY SAVE".

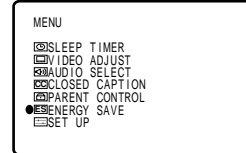
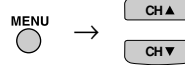

(MAIN MENU screen)

- Press **VOL +/-** to access the ENERGY SAVE select screen.

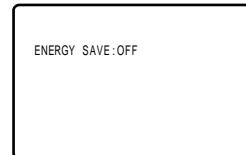
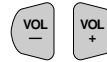

(ENERGY SAVE select screen)

- Press **VOL +/-** to select "ON".

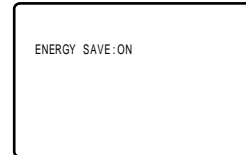
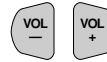

- Press **MENU** to exit.



Set Up

■ EZ Setup

By operating the channel preset functions, you can preset your TV to the desired channels for viewing.

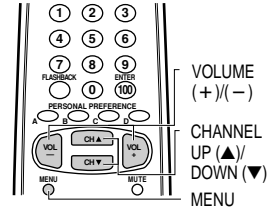

- 1 Press **MENU** to access the MAIN MENU screen.
- 2 Press **CH ▲/▼** to move the “●” mark to “SET UP”.

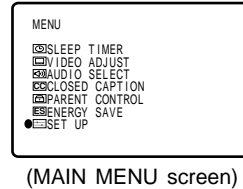
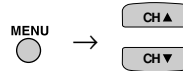

- 3 Press **VOL +/-** to access the SET UP screen, then press **CH ▲/▼** to move the “●” mark to “CH SETTING”.

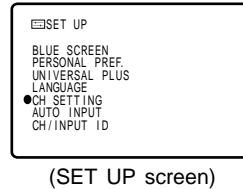
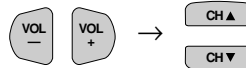

- 4 Press **VOL +/-** to access the CH SETTING screen.

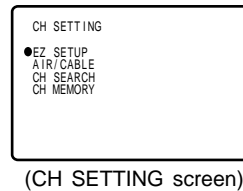
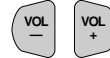

- 5 Press **VOL +/-** to access the EZ SETUP screen.

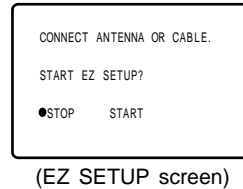
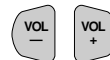

- 6 Press **VOL +**.
 The tuner will automatically search for the broadcasting and cable TV channels. (The CH No. will automatically increase when it appears.)

If you want to stop the EZ SETUP process once it has started, press **VOL -**. Search will be canceled.

To cancel EZ SETUP
 Press **VOL -**.

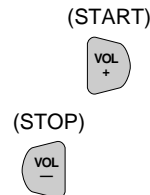

- 7 Once EZ SETUP is complete, the lowest channel number memorized will be displayed.

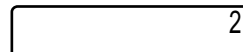

Set Up (Continued)

■ Channel Setting

If EZ SETUP does not memorize all the channels in your region, follow the instructions below to manually memorize the channel.

- 1 Press **MENU** to access the MAIN MENU screen.
- 2 Press **CH ▲/▼** to move the “●” mark to “SET UP”.

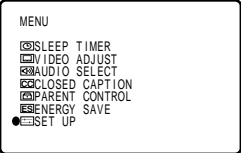
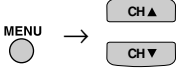

(MAIN MENU screen)

- 3 Press **VOL +/-** to access the SET UP screen.
- 4 Press **CH ▲/▼** to move the “●” mark to “CH SETTING”.

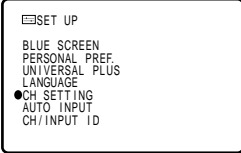
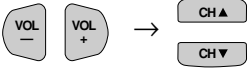

(SET UP screen)

- 5 Press **VOL +/-** to access the CH SETTING screen.

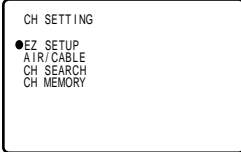
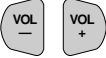

(CH SETTING screen)

- 6 Press **CH ▲/▼** to move the “●” mark to “AIR/CABLE”, then press **VOL +/-** to access the AIR/CABLE screen.

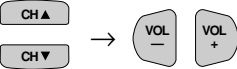

- 7 Press **CH ▲/▼** to move the “●” mark to the desired mode.

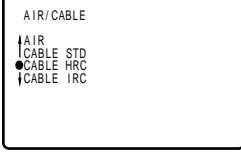
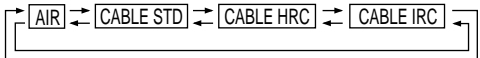

(AIR/CABLE screen)

- 8 Press **MENU** to exit.



Note:

- Receivable channels of your TV set are:

AIR channels: VHF: 2 through 13. UHF: 14 through 69.	CABLE channels: 1 (HRC and IRC mode only) 2 through 125 (STD, HRC and IRC)
--	--

Set Up (Continued)

• Saving broadcast TV channels into memory

- 1** Press **MENU** to access the MAIN MENU screen, then press **CH ▲/▼** to move the “●” mark to “SET UP”.

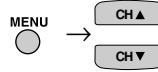

- 2** Press **VOL +/-** to access the SET UP screen, then press **CH ▲/▼** to move the “●” mark to “CH SETTING”.

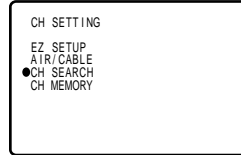
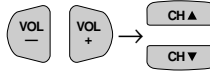

(CH SETTING screen)

- 3** Press **VOL +/-** to access the CH SETTING screen.

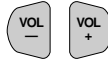

- 4** Press **CH ▲/▼** to move the “●” mark to “CH SEARCH”, then press **VOL +/-** to access the CH SEARCH screen.

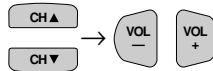

(CH SEARCH screen)

To start:

Press **VOL +**. The tuner will search through all available channels in your area and add them into the TV memory.

(START)



To stop:

Press **VOL -**. CH SEARCH will stop at the current channel and will not add any higher channels.

(STOP)



- 5** Press **MENU** to exit.



Note:

- If you press **VOL +** again while in the CH SEARCH mode, auto-program will start again, and the previously memorized channels will be lost.

• Adding weak or additional channels or erasing unwanted channels from TV memory

- 1** Press **MENU** to access the MAIN MENU screen, then press **CH ▲/▼** to move the “●” mark to “SET UP”.

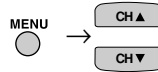

- 2** Press **VOL +/-** to access the SET UP screen, then press **CH ▲/▼** to move the “●” mark to “CH SETTING”.

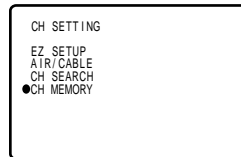
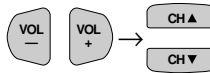

(CH SETTING screen)

- 3** Press **VOL +/-** to access the CH SETTING screen.

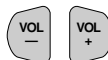

- 4** Press **CH ▲/▼** to move the “●” mark to “CH MEMORY”, then press **VOL +/-** to access the CH MEMORY screen.

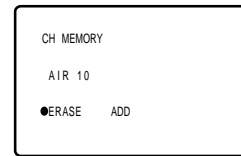
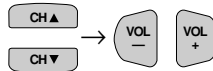

(CH MEMORY screen)

- 5** Use **CH ▲/▼** or **REMOTE KEYPAD** to select each desired channel to add or erase.

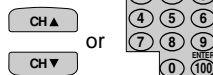

Set Up (Continued)

6 Press **VOL +** to add a channel to the TV memory or press **VOL -** to erase a channel from the TV memory.

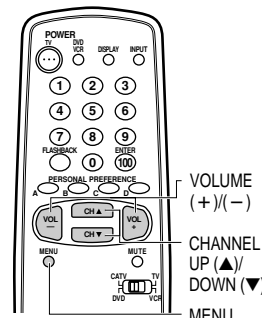
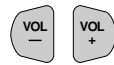
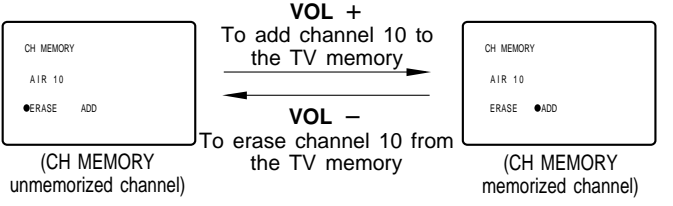

7 Press **MENU** to exit.



■ BLUE SCREEN
Automatically turns the screen blue if a broadcast signal is not received. After 15 minutes of non-reception, the TV will turn off automatically.

1 Press **MENU** to access the MAIN MENU screen.
2 Press **CH ▲/▼** to move the “●” mark to “SET UP”.

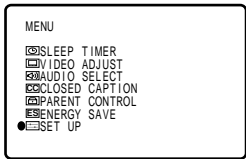
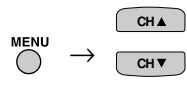

(MAIN MENU screen)

3 Press **VOL +/-** to access the SET UP screen.

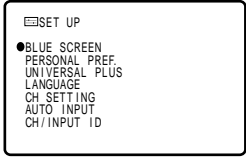
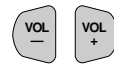

(SET UP screen)

4 Press **VOL +/-** to access the BLUE SCREEN select screen.

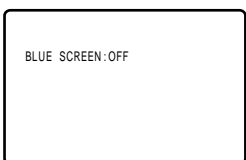
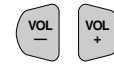

(BLUE SCREEN select screen)

5 Press **VOL +/-** to select “ON”.

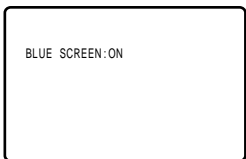
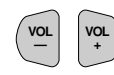

Set Up (Continued)

6 Press **MENU** to exit.



When the BLUE SCREEN is set to "ON"

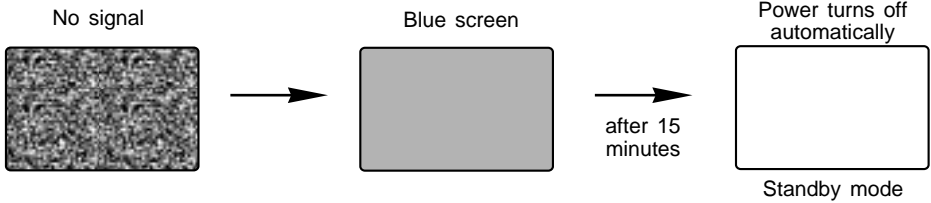

Note: →

- Poor reception due to weak signals, or too much noise might activate the BLUE SCREEN function despite the presence of a broadcast signal. To continue watching TV under these conditions, switch the BLUE SCREEN "OFF".
- While INPUT 1, 2, or 3 (COMPONENT) is selected, the BLUE SCREEN will not be shown even if BLUE SCREEN is turned on.

Set Up (Continued)

Personal Preference

By setting **PERSONAL PREFERENCE** channels in advance, you can select your favorite channels easily.

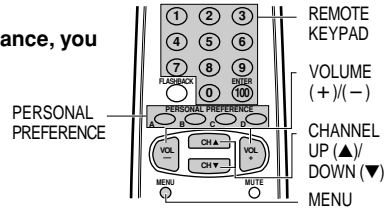

- 1 Press **MENU** to access the MAIN MENU screen.
- 2 Press **CH ▲/▼** to move the "●" mark to "SET UP".

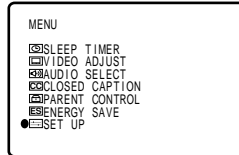
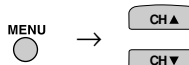

(MAIN MENU screen)

- 3 Press **VOL +/-** to access the SET UP screen, then press **CH ▲/▼** to move the "●" mark to "PERSONAL PREF."

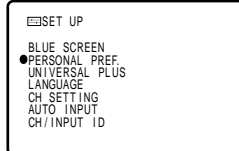
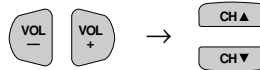

(SETUP screen)

- 4 Press **VOL +/-** to select the **PERSONAL PREFERENCE** select screen in which you can program 4 favorite channels, in 4 different categories. (total of 16 channels)

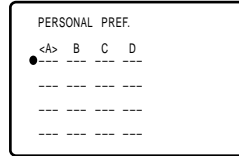
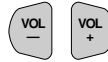

(PERSONAL PREFERENCE select screen)

- 5 Press **VOL +/-** and **CH ▲/▼** to move the "●" mark to the desired position.

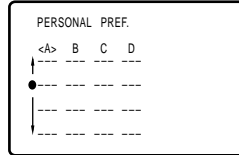

- 6 Press **REMOTE KEYPAD** on the Remote to input the CHANNEL Number into memory. Press **INPUT** on the Remote to register the INPUT mode into memory.

Example: 125 — Press "100" followed by "2" and then "5".
 25 — Press "2" and then "5".
 4 — Press "0" and then "4".



To reset a registered CHANNEL Number, input "0" twice.

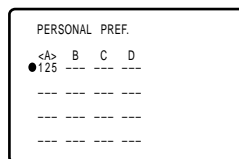

- 7 Repeat steps 5 and 6 to register the next CHANNEL Number or INPUT mode.

- 8 Press **MENU** to exit.



To select the **PERSONAL PREFERENCE** channel.

If the channels are memorized as shown on the right, press the Remote's "A" button to select the channels below.

→ 125 → 25 → 40 → 4

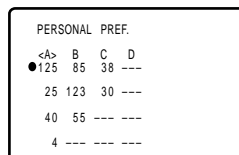

Set Up (Continued)

■ Universal Plus Function

VCR or DVD input mode will be selected automatically by pressing the VCR/DVD PLAY button on the Remote Control.

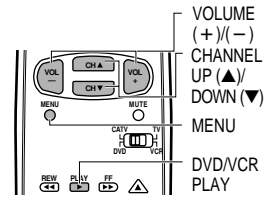

- 1 Press **MENU** to access the MAIN MENU screen.
- 2 Press **CH ▲/▼** to move the “●” mark to “SET UP”.

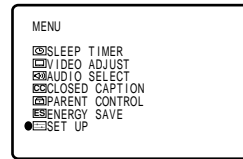
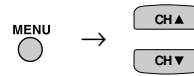

(MAIN MENU screen)

- 3 Press **VOL +/-** to access the SET UP screen.

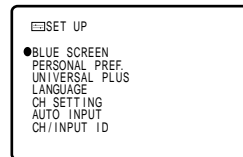
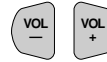

(SET UP screen)

- 4 Press **CH ▲/▼** to move the “●” mark to “UNIVERSAL PLUS”.

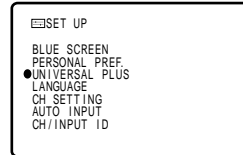

- 5 Press **VOL +/-** to access the UNIVERSAL PLUS select screen to select VCR or DVD mode.

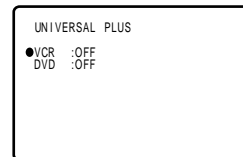
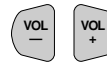

(UNIVERSAL PLUS select screen)

- 6 Press **CH ▲/▼** to select the VCR or DVD, and press **VOL +/-** to select “CH3”, “CH4”, “INPUT 1”, “INPUT 2”, “INPUT 3 (COMPONENT)” or “OFF”.

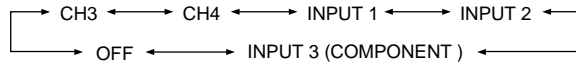

Switch to the input mode your VCR or DVD is connected to. If connected through RF (antenna terminal), select either CH3 or CH4 to match the setting of the VCR or DVD.

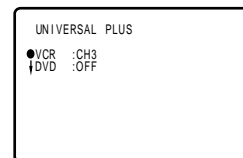
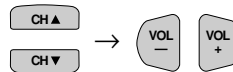

- 7 Press **MENU** to exit.



Auto Input

- The unit is preset to switch to the INPUT 2 screen automatically when VIDEO equipment is connected to the INPUT 2 terminal. Do the following to switch this feature off:

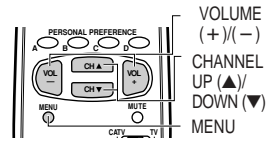

- Press **MENU** to access the MAIN MENU screen.
- Press **CH ▲/▼** to move the “●” mark to “SET UP”.

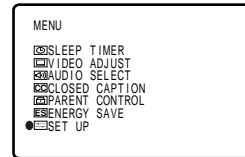
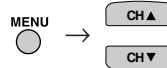

(MAIN MENU screen)

- Press **VOL +/-** to access the SET UP screen, then press **CH ▲/▼** to move the “●” mark to “AUTO INPUT”.

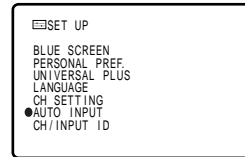
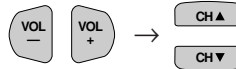

(SET UP screen)

- Press **VOL +/-** to access the AUTO INPUT select screen.
Press **VOL +/-** to select “AUTO”.

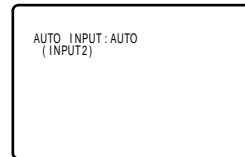
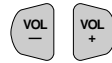

(AUTO INPUT select screen)

- You may turn off “AUTO INPUT” when it is not in use.
Press **VOL +/-** to select “OFF”.

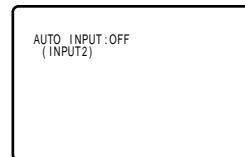
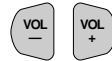

- Press **MENU** to exit.



CH/Input ID

- You can assign an ID label to each channel or input mode. These ID labels can be 4 characters long maximum and will be displayed along with the channel number/input mode when the labeled channel is selected. (Example: labeling air channel 10 "TV12".)

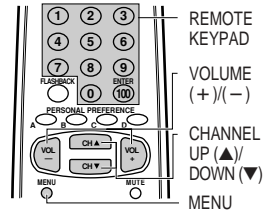

- Press **MENU** to access the MAIN MENU screen.

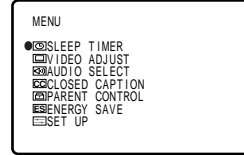

(MAIN MENU screen)

- Press **CH ▲/▼** to move the "●" mark to "SET UP".

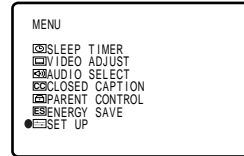

- Press **VOL +/-** to access the SET UP screen then press **CH ▲/▼** to move the "●" mark to "CH/INPUT ID".

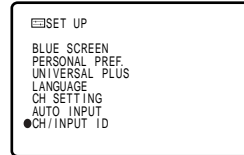
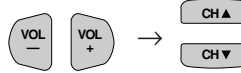

(SET UP screen)

- Press **VOL +/-** to access the CH/INPUT ID screen.

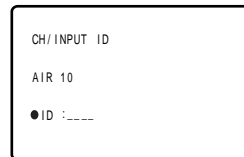
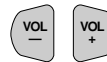

(CH/INPUT ID screen)

CH/Input ID (Continued)

- 5** Use **CH ▲/▼** or **REMOTE KEYPAD** to select each desired channel to label.
Press **INPUT** on the Remote to label the INPUT mode.

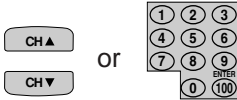

ID: Labeling the channel name

Press **VOL +/-** to select "ID" then press **VOL +** to select the first character. Press **CH ▲/▼** to enter a desired letter. Press **VOL +/-** to enter the next desired letter. Press **MENU** to return to the CH/INPUT ID screen.

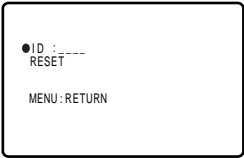
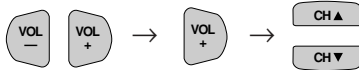

(ID Input screen)

Selectable characters:

- Space: _
- Alphabets: A-Z
- Numbers: 0-9
- Symbols: — . & () / +

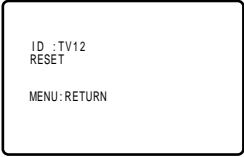
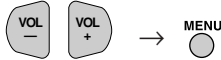

Example TV 12

RESET: Resetting the ID to “_ _ _ _”

Press **CH ▲/▼** to move the “●” mark to “RESET”, then press **VOL +/-**. The previously set ID will return to “_ _ _ _”.

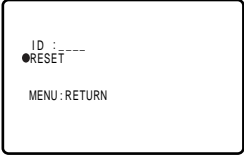
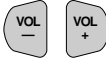
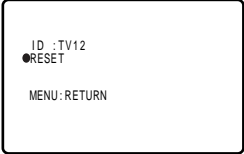

- 6** Press **MENU** to exit.



Note:

- The maximum number of ID labels available to register channel names is 20 for AIR channels and 40 for CABLE channels.
- If you wish to register a new ID when all the available ID labels are assigned, delete a registered ID to make room.

Using the Video and Audio Input Terminals

- **Connecting video equipment for playback of video material.**
- To view video material from external video equipment, make sure to connect the equipment properly to the input terminals on the TV set.

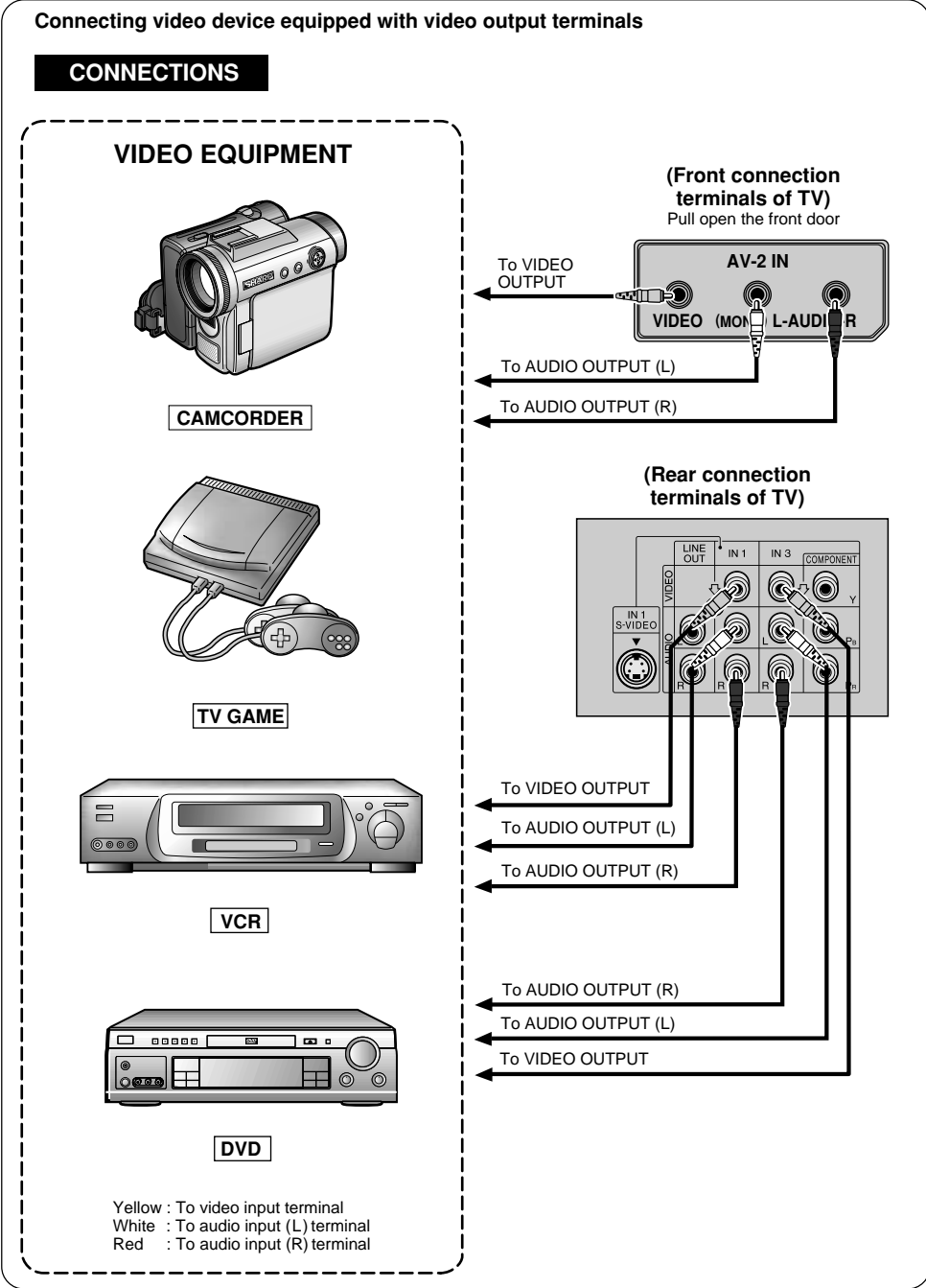

Using the Video and Audio Input Terminals (Continued)

Notes:

- COMPONENT terminals are DVD compatible, allows you to enjoy the highest quality playback image than the image from IN 1 S-VIDEO terminal.
- The IN 1 S-VIDEO terminal is used to obtain a higher quality image by importing image signals.
- The S-VIDEO terminal is for the video image only. To receive an audio signal, connect the audio cable to the IN 1 AUDIO terminals (left and right).

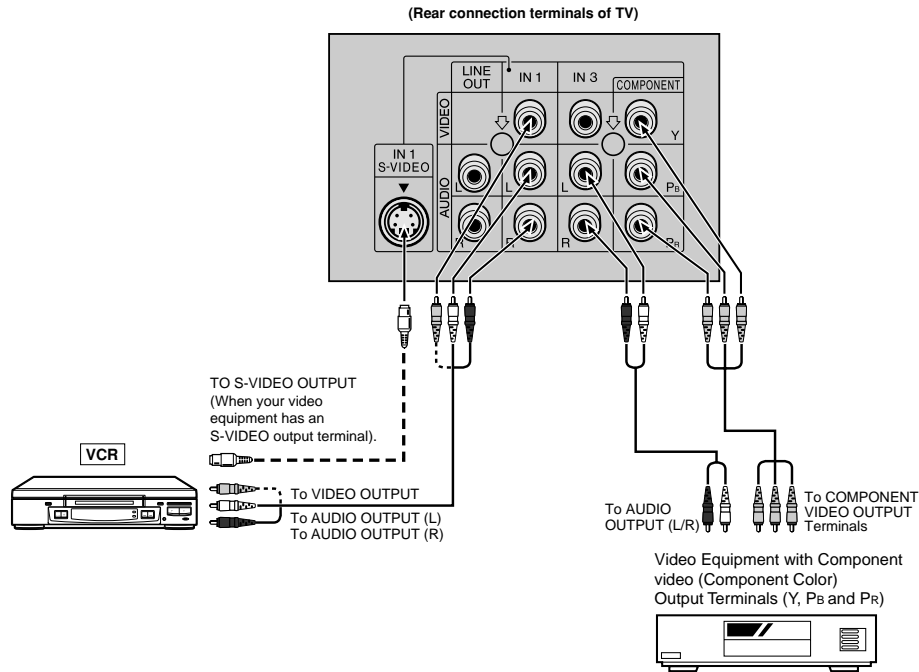

• To watch video material playback

- Press the Remote's **INPUT** button to select the VIDEO INPUT mode for the video equipment you wish to play.
- The external VIDEO INPUT mode will change as follows each time the **INPUT** button is pressed.

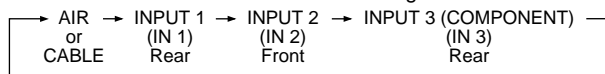

- When the AV cables are connected to the VIDEO INPUT 3 and COMPONENT Y, P_B and P_R terminals simultaneously, the COMPONENT terminal has priority over the VIDEO terminal.
- INPUT mode can be selected by pressing either the **CH ▲** on the TV remote control when the TV is set to the highest channel stored in memory, or by pressing the **CH ▼** when it is set to the lowest channel.

Note:

- When connecting video or audio equipment to the television, be sure that the power is turned off in order to prevent damage to either the television or the equipment being connected.
- The S-Video terminal has priority over the VIDEO terminal (IN 1). When you wish to use video equipment connected to the VIDEO terminal (IN 1), unplug equipment connected to the S-VIDEO terminal.
- For detailed information on the connection and use of auxiliary equipment, refer to the instruction manuals of the equipment being used.
- The connection cables/cords can be obtained from your local video store.

Using the Audio Output Terminals

- These terminals are used for connecting an external audio amplifier. The STEREO/MONO/SAP, VOLUME, MUTE and FAO functions can all be controlled via the television's remote control or directly on the TV itself. These terminals relay the audio signal of all programs being displayed on the TV screen.

(AUDIO OUTPUT terminals are located on the rear of the cabinet.)

CONNECTIONS

(Rear connection terminals of TV)

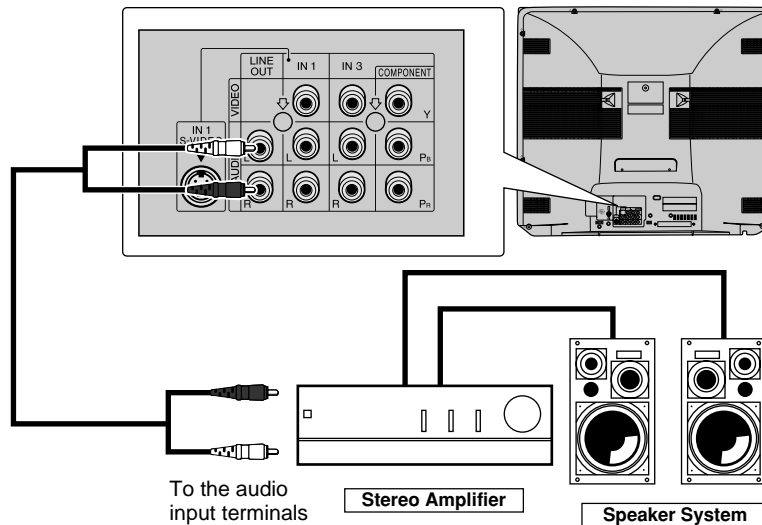

- (1) Before connecting the cables, turn on the TV and adjust the TV volume for a moderate listening level.
- (2) Turn off the TV and connect the audio cables to the AUDIO LINE OUTPUT terminals on the TV.
- (3) Turn the TV set and stereo amplifier on.
- (4) If you desire, you can turn off the sound of the TV's internal speakers by accessing the TV's AUDIO SELECT screen. See pages 13, 14.
- (5) Adjust the volume control on the stereo amplifier to a moderate listening level.
- (6) Control of the audio can be adjusted using the audio controls (STEREO/MONO/SAP, VOLUME, MUTE and FAO), from either the remote control, or directly from the TV set.

Note:

- For detailed information on the connection and use of auxiliary equipment, refer to the operation manuals of the equipment being used.
- When connecting monaural equipment to the AUDIO INPUT or OUTPUT of this set, use an audio connection cord and plug adaptor as shown below.
- When FAO is set to "OFF", we recommend you to keep the TV's audio output level high for optimal sound quality. (see page 13.)

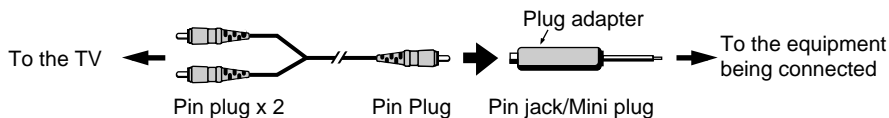

Operation of Universal Remote Control

• Universal Remote Control

With the purchase of your television set you also have received the latest innovation in remote control technology. With its easy-to-use push button keyboard, your Remote can control your television set and most infrared remote controlled VCRs, cable TV converters and DVDs as well.

Note:

- Depending on the model year produced, brand and type of VCR, cable TV converter and DVD, some models may not be compatible with the remote control.
- Some brands may not enable channel selection until the **ENTER** is pressed. In such case, try the following.

Example:

- When you select channel 24,
- (1) Press **REMOTE KEYPAD** "2".
 - (2) Press **REMOTE KEYPAD** "4".
 - (3) Press **ENTER**.

For detailed information on the use of the Cable TV converter Box refer to their operating manuals.

• Using your Remote with your TV

After installing the batteries, set the **CATV/ DVD-TV/VCR** on the Remote to the TV position. (If you can change the channel of the TV by pressing **CH ▲/▼** on the Remote Control, it is in the TV position.)

• "Identifying" VCRs, cable TV converters and DVDs

Your Remote Control has been set at the factory to operate your TV and many remote controlled VCRs, cable TV converters and DVDs. However, in some cases an easy one-time set-up step may be necessary before the Remote will operate accessory VCRs, cable TV converters and DVDs.

- In this set-up step, the Remote locates and memorizes the remote control transmitter code for the VCR, cable TV converters and DVDs.
- Once "identified", the Remote sends proper signals to operate your accessory.
- This identifying step will not have to be repeated until power to the Remote is interrupted due to a battery failure.

• Using your remote control with a VCR

Once you make certain the Remote Control has "identified" your remote controlled VCR or DVD, the Remote is ready to operate your unit. The various VCR or DVD function buttons on the Remote will not operate your VCR or DVD if those features are not already found on your unit.

- All VCR buttons will operate whether the Remote is in TV or VCR modes.
- For detailed information on the use of the VCR or DVD, refer to the operation manual of the VCR or DVD.

DVD/VCR POWER

Press to turn the VCR or DVD on and off.

PLAY ►

Press to playback a tape or disc.

REWIND ◀◀

Press to rewind a tape or reverse a disc. For some VCRs or DVDs you may need to press **STOP** first, then **REWIND**.

PAUSE II

Press to temporarily stop the tape or disc during playback or recording (VCR only). Press again to release **PAUSE**.

STOP ■

Press to stop the tape or disc.

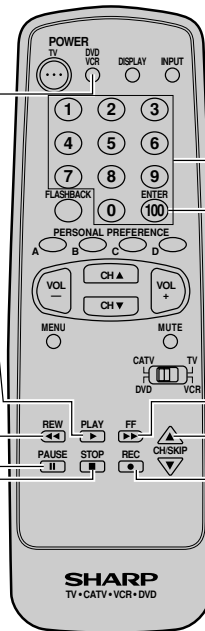

REMOTE KEYPAD

Use to enter two-digit code numbers when identifying your VCR, DVD and CATV converter.

ENTER

FF ►►

Press to rapidly advance the tape or disc. For some VCRs or DVDs, you may need to press **STOP** first, then **FF**.

VCR CHANNEL UP (▲)/ DOWN (▼)

Press to scan up or down through channels on the VCR.

DVD SKIP

Press to jump forward to the beginning of the next chapter/track, or backward to the beginning of the current chapter/track, and automatically start to play that chapter/track.

RECORD ●

Press to begin recording. (VCR only)

Operation of Universal Remote Control (Continued)

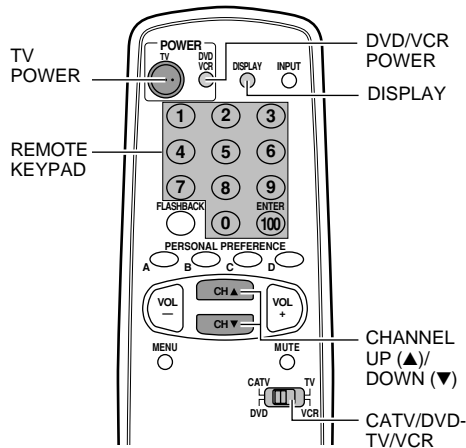

• How to identify a VCR

The remote control may already be set to operate your VCR. Try this initial check before going on to the following "identifying" section.

- (1) Slide **CATV/DVD-TV/VCR** switch to VCR.
- (2) Point the Remote towards VCR and press **POWER (DVD/VCR)**.
- (3) Does the Remote turn the VCR ON and OFF?
 - If yes, the Remote is ready to operate the VCR and no further steps are needed.
 - If no, continue to the "identifying" section.

Setting Method

Refer to the following steps and list to quickly find the remote control code for your accessory VCR.

- First look up your VCR's remote control code number before going through the Setting Method.
- (1) Slide **CATV/DVD-TV/VCR** switch to VCR.
 - (2) Press and hold down **DISPLAY** and **CH ▼** on your remote control. Then release both buttons.
 - (3) Within 10 seconds after releasing **DISPLAY** and **CH ▼**, enter your VCR's two-digit remote control code number using the **REMOTE KEYPAD** (refer to the list).
 - The remote control is now ready to send commands to your VCR.

Some brands have more than one remote code listed, due to changes in the remote codes from early to later model years, or due to format differences (VHS/BETA). In such cases, you may have to try more than one code to find the code your VCR accepts.

Note: ➤

Depending on the model, year produced, brand, and type of VCR, some models may not be compatible with the remote control.

VCR BRAND	REMOTE CONTROL CODE NUMBER
Akai	25, 26, 37
Audio Dynamics	15, 22, 30
Broksonic	32
Canon	04
Capehart	34
Craig	10, 31
Curtis Mathis	04
Daewoo	34
DBX	15, 22, 30
Dynatech	29
Emerson	21, 32, 35
Fisher	09, 10, 11
Funai	28, 29
GE	04
Goldstar	24
Hitachi	06
Instant Replay	04
JC Penney	04, 06, 24, 30
JVC	15, 41, 42
Kenwood	14, 15
Lloyds	29
Magnavox	04, 05, 08
Magnin	31
Marantz	30
Memorex	04, 10, 24, 29
Minolta	06
Mitsubishi	17, 18, 39, 40
Montgomery Ward	02, 43
Multitech	29
NEC	15, 22, 30
Panasonic	04, 44, 45
Pentax	05, 06
Philco	04, 05
Philips	04, 05, 08
Quasar	04
RCA	06, 07, 33
Realistic	01, 02, 10, 24
Samsung	23, 31
Sanyo	14, 10
Scott	20
Sears	06, 11, 24
Sharp	01, 02, 03
Shintom	36
Sony	12, 13, 38
Sound Design	29
Sylvania	04, 05, 08
Symphonic	29
Tatung	15
Teac	15, 29
Teknika	27, 29
Thomas	29
TMK	21
Toshiba	19, 20
Video Concepts	30
Yamaha	15, 29, 30
Zenith	16

Operation of Universal Remote Control (Continued)

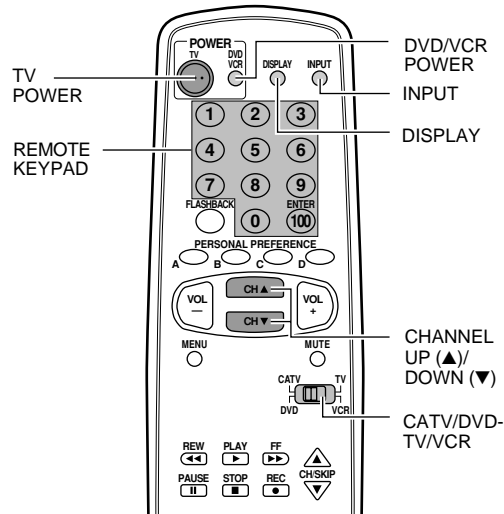

• How to identify a DVD

The remote control may already be set to operate your DVD. Try this initial check before going on to the following "identifying" section.

- (1) Slide **CATV/DVD-TV/VCR** switch to DVD.
- (2) Point Remote towards DVD and press **DVD/VCR POWER**.
- (3) Does the Remote turn the DVD ON and OFF?
 - If yes, the Remote is ready to operate the DVD and no further steps are needed.
 - If no, continue to the "identifying" section.

Setting Method.

Refer to the following steps and list to quickly find the remote control code for your accessory DVD.

- First look up your DVD's remote control code number before going through the Setting Method.
- (1) Slide **CATV/DVD-TV/VCR** switch to DVD.
 - (2) Press and hold down **INPUT** and **CH ▼** on your remote control. Then release both buttons.
 - (3) Within 10 seconds after releasing **INPUT** and **CH ▼**, enter your DVD's two-digit remote control code number using **REMOTE KEYPAD** (refer to the list).
 - The remote control is now ready to send commands to your DVD.

DVD BRAND	REMOTE CONTROL CODE NUMBER
Denon	02
JVC	09
Magnavox	04
Marantz	04
Mitsubishi	06
Panasonic	02
Philips	04
Pioneer	08
Proscan	03
RCA	03
Samsung	07
Sharp	01, 10
Sony	05
Toshiba	04
Yamaha	02
Zenith	04

Note:

Depending on the model, year produced, brand, and type of DVD, some models may not be compatible with the remote control.

Operation of Universal Remote Control (Continued)

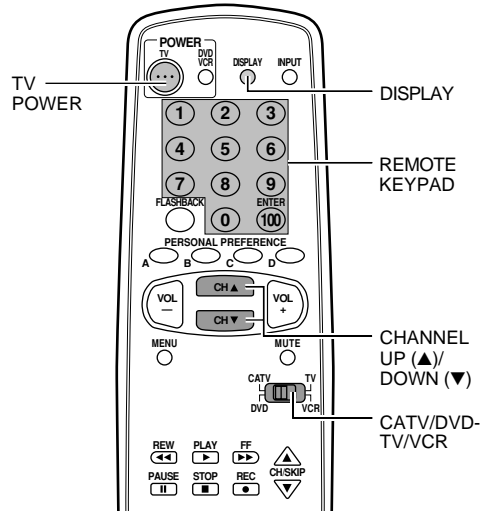

- **How to identify a cable converter**

Setting Method.

Refer to the following steps and list to quickly find the remote control code for your cable TV converter.

- First look up your converter's remote code number before going through the Setting Method below.
- (1) Slide **CATV /DVD-TV/VCR** switch to **CATV**.
- (2) Press and hold down **DISPLAY** and **CH ▼** on your remote control. Then release both buttons.
- (3) Within 10 seconds after releasing **DISPLAY** and **CH ▼**, enter your converter's two-digit code number using **REMOTE KEYPAD** (refer to the list).
- The remote control is now ready to send commands to your converter.
- Some brands have more than one remote code listed due to changes in the remote codes from early to later model years. In such cases, you may have to try more than one code to find the code your converter accepts.

Note: ➤

Depending on the model, year produced, brand, and type of CATV converter, some models may not be compatible with the remote control.

CATV CONVERTER BRAND	REMOTE CONTROL CODE NUMBER
Anvision	07, 08
Cable Star	07, 08
Eagle	08
General Instrument	04, 05, 15, 23, 24, 25, 30, 36
Jerrold	04, 05, 15, 23, 24, 25, 30, 36
Magnavox	07, 08, 19, 25, 28, 29, 32, 33, 40, 41
Oak Sigma	18
Panasonic	27, 39
Philips	07, 08, 19, 26, 28, 29, 32, 33, 40, 41
Pioneer	18, 20
Randtek	07, 08
RCA	27, 43
Scientific Atlanta	03, 22, 42
Sony	44
Viewstar	07, 08, 19, 26, 28, 29, 32, 33, 40, 41
Zenith	14

Before Calling for Service

Check these items and see if you can correct the trouble with a slight adjustment of the controls.

QUICK SERVICE CHECK LIST	PROBLEM	No Playback of VCR and Disc Player	No Picture or Sound from External Video/Audio Products	Remote Control Doesn't Work	Bars on Screen	Picture Distorted	Picture Rolls Vertically	No Color	Poor Reception on Some Channels	Weak Picture	Lines or Streaks in Picture	Ghosts in Picture	Picture Blurred	Sound OK, Picture Poor	Picture OK, Sound Poor	No Picture or Sound	Dark and Blank Picture	External Electrical Noise Interfering with TV's Operation	Color on Part of the Screen Appears Distorted
POSSIBLE REMEDY																			
Try a new channel, if OK, then there is a possible station trouble.					X	X	X	X	X	X	X	X	X	X	X				
Is TV plugged in? Power at outlet?		X	X													X			
Is TV's POWER button on?		X														X			
Is antenna connected to terminal on the back of the set?							X	X	X		X		X		X				
If outside antenna is being used, check for broken wire.				X	X	X	X	X	X	X	X	X	X	X	X				
Check for local interference or external electrical noise.				X		X		X		X	X		X	X			X		
Turn off the POWER and then turn it on after about a minute.		X														X			
Adjust COLOR control.							X												
Adjust PICTURE control.										X				X					
Check external Video/Audio products: look for loose/broken connection leads. (Refer to pages 38-40)	X	X												X	X	X			
Check batteries of Remote Control.			X																
Slide CATV/DVD-TV/VCR Select Switch to TV position.			X																
Are audio cables connected firmly? Check the volume level.																X			
Is SPEAKER ON? See pages 13, 14.																X			
Change Closed Caption mode to "OFF"/Energy Save mode to "OFF".																	X		
Unplug the TV and plug it in again after 2 minutes or longer.			X			X	X	X	X					X	X	X	X	X	X

Note:

- If no TEXT broadcast is being received while viewing in the TEXT mode, the screen may become dark and blank for some programs. Should this occur, switch the Closed Caption mode to "OFF".



(Dark and Blank Picture)

Calling for Service

For location of the nearest Sharp Authorized Servicer, or to obtain product literature accessories, supplies, or customer assistance, please call 1-800-BE-SHARP.

Specifications

MODEL	27F541		
Receiving System	NTSC		
Stereo Broadcast	MTS/SAP		
Reception Channels			
AIR	VHF	2-13 ch	
	UHF	14-69 ch	
CATV	1-125 ch		
Channel Tuning	181-channel Reception PLL tuning system		
Antenna Input Impedance	VHF/UHF 75 ohm Unbalanced		
Screen Size	27" Diagonally Measured		
Terminals	Audio/Video input x 3 (Front x 1, Rear x 2) S-Video input x 1 (Rear) COMPONENT-IN x 1 (Rear) Audio output x 1 (Rear) Antenna x 1 (Rear)		
Sound Output	5 W (RMS) x 2		
Power Source	AC 120 V, 60 Hz		
Power Consumption	130 W		
Dimensions [(W) x (H) x (D)] mm	29 ³¹ / ₃₂ " (W) x 23 ⁹ / ₁₆ " (H) x 20 ¹⁷ / ₆₄ " (D) [761 mm (W) x 598.5 mm (H) x 515 mm (D)]		
Weight (approx.)	91.9 lbs. (41.7 kg)		

- Design and specifications are subject to change without notice.