

# LAVAMAT W 1460 ELECTRONIC

Washing Machine

User information



## Dear Customer,

Please read this user information carefully.

Pay particular attention to the section "Safety" on the first Info pages.

Please keep this user information in a safe place for later reference.

Pass it on to any future owners of the unit.



The warning triangle and /or signal words (**Warning!**, **Caution!**, **Important!**) emphasise information which is important for your safety or for the unit's functional reliability. It is imperative that this information is observed.



**1.** This symbol guides you step by step through the operation of the appliance.

**2.** ...



Next to this symbol you will find additional information and practical tips on using the appliance.



Tips and information on economical and environmentally responsible use of the unit are identified with the clover leaf.

For any faults which occur, this user information contains information on how to remedy these faults yourself. See the section "What to do if ..."

Printed on recycled paper.

Thinking ecologically means acting ecologically.

# Contents

<b>Operating Instructions</b> .....	6
<b>Safety</b> .....	6
<b>Disposal</b> .....	8
<b>Environmental tips</b> .....	9
<b>Unit description</b> .....	10
Front view .....	10
Drawer for Detergent and Conditioners .....	10
Control Panel .....	11
Programme selector .....	11
Programme Option Buttons .....	13
<b>Consumption Values and Programme Times</b> .....	13
<b>Before the First Wash</b> .....	15
<b>Prepare washing cycle</b> .....	15
Sort washing and prepare .....	15
Types of Washing and Care Symbols .....	16
Washing Detergents and Care Agents .....	17
Which washing detergent and care agent? .....	17
How much washing detergent and care agent? .....	17
Water softener .....	17
<b>Running a washing cycle</b> .....	18
Brief instructions .....	18
Opening and closing the door .....	19
Add the washing .....	19
Adding detergent/conditioners .....	20
Setting the washing programme .....	21
Changing Spin Speed/selecting RINSE HOLD .....	21
Starting the Wash Programme .....	22
Programme Progress .....	22
Changing the washing programme .....	22
Washing cycle complete/removing the washing .....	23

<b>Programme Tables</b> .....	24
Washing .....	24
Separate Rinsing .....	25
Separate Spinning .....	25
<b>Cleaning and Care</b> .....	26
Control panel .....	26
Detergent Drawer .....	26
Washing Drum .....	27
Main door .....	27
<b>What to do if ...</b> .....	28
Remedying Faults .....	28
If the washing results are not satisfactory .....	32
Carrying out emergency drainage .....	33
Drain pump .....	34
Additional rinse cycles (RINSE+) .....	36
<b>Child Safety Feature</b> .....	37
<b>Installation and connection instructions</b> .....	38
<b>Installation Safety Precautions</b> .....	38
<b>Installation of the appliance</b> .....	39
Transporting the appliance .....	39
Remove transport packaging .....	39
Prepare the installation place .....	41
Installation on a concrete base .....	41
Installation on vibrating floors .....	41
Compensate for floor unevenness .....	42

---

<b>Electrical connection</b> .....	43
<b>Water connection</b> .....	43
Permissible water pressure .....	43
Water inflow .....	44
Water drain .....	45
Delivery heads over 1m .....	45
<b>Technical data</b> .....	46
<b>Dimensions</b> .....	46
<b>Warranty conditions / Customer service centres</b> .....	47
<b>Index</b> .....	50
<b>Service</b> .....	51

# Operating Instructions



## Safety

The safety aspects of AEG electrical appliances comply with accepted technical standards and the German Appliance Safety Law. However, as manufacturers we regard it as our responsibility to inform you about the following safety instructions.

### Before Using for the First Time

- Refer to the "Installation and Connection Instructions" further on in this user information.
- If units are delivered in the winter months at minus temperatures: Store the washing machine at room temperature for a few hours before putting it into operation.

### Correct Use

- The washing machine is only intended for washing normal domestic washing. If the appliance is used for a wrong purpose or wrongly operated, the manufacturer cannot assume any liability for any damages.
- Additions or modifications to the washing machine are strictly forbidden due to safety reasons.
- Use only detergent which is suitable for washing machines. Refer to the detergent manufacturer's instructions.
- The washing must not contain any flammable solvents. Also bear this in mind when washing pre-cleaned washing.
- Do not use the washing machine for dry-cleaning.
- Dyes /dye-removing agents may only be used in the washing machine if the manufacturer expressly permits use of these products. We cannot accept liability for any damage.
- Use only water from the water mains. Use rain water or service water only if it meets the requirements defined in DIN 1986 and DIN 1988.
- Frost damage is not covered by the warranty! If the washing machine is in a room subject to possible frost hazards, emergency emptying must be carried out if there is a risk of frost (see the Section "Carrying out emergency emptying").

## Safety of Children and Infirm Persons

- Packaging materials (e.g. films, polystyrene) can be dangerous for children. Risk of suffocation! Keep packaging away from children.
- The appliance is not intended for use by young children or infirm persons without supervision.
- Children frequently cannot recognise hazards involved in handling electrical appliances. Therefore, ensure that they are properly supervised during operation and never allow children to play with the washing machine – there is a risk that they can lock themselves inside it.
- Ensure that children or small animals do not climb into the washing machine's drum.
- When disposing of washing machines pull out the mains plug, destroy the door lock, cut off the electrical supply lead and dispose of the plug and remaining cable. This means that playing children cannot shut themselves in and cannot encounter a potentially lethal hazard.

## General Safety

- Repairs to the washing machine may only be carried out by qualified specialists. Incorrect repairs may result in significant risk to the user. If repairs are necessary, consult our customer service or your specialist dealer.
- Never use the washing machine if the mains cable is damaged or the control panel, work surface or base panel area are so badly damaged that the interior of the unit is openly accessible.
- Switch off the washing machine before carrying out cleaning, care and maintenance work. Also pull the mains plug out of the socket or, – if it is permanently connected, – switch off the circuit breaker at the household power distribution box or completely remove the screw-in fuse.
- If operation is stopped, disconnect the appliance from the mains supply and shut off the tap.
- Never pull the cable to remove the plug from the socket. Always pull the plug itself.
- Multiple connectors, couplings and extension cables must not be used. **There is a risk of fire with overheating!**
- Do not spray down the washing machine with a water jet. Risk of electric shock!
- The glass in the door becomes hot in the case of wash programmes with high temperatures. Do not touch!

- Allow the washing solution to cool before carrying out an emergency emptying operation or cleaning the drain pump.
- Small animals can chew the power cables and water hoses. Risk of electric shock and danger of water damage! Keep small animals away from the washing machine.



## Disposal

### **Disposing of the Packaging Material!**

Dispose of the packaging of your washing machine correctly. All packaging materials used are environmentally-compatible and recyclable.

- Plastic parts are identified with internationally standardised abbreviations:
  - >PE< for polyethylene, e.g. packing films.
  - >PS< for polystyrene, e.g. cushion parts (always CFC-free)
  - >POM< for polyoxymethylene, e.g. plastic clips.
- Cardboard packaging is manufactured from recycled paper and should be deposited in the waste paper collection for recycling.

### **Disposing of your old appliance!**

When you put your unit out of operation one day, please bring it to your nearest recycling centre or to your dealer.





## Environmental tips

- A pre-wash cycle is not necessary in the case of washing which is not excessively dirt. This saves detergent, water and time (and is gentle on the environment.)
- If the indicated load capacities are taken full advantage of, the washing machine is especially efficient.
- For small loads, use only one half to one third of the recommended detergent quantity.
- Suitable pre-treatment enables marks and limited amounts of dirt to be removed. You can then wash at a lower temperature.
- Wash slightly to normally dirty cottons with the energy-saving program.
- There is often no need for the softener. Try it once! If you use a drier, your washing will become soft and fluffy even without a softener.
- In the case of medium to high water hardness (hardness range runs to upwards, see "Detergent and care agents"), you should use a water softener. The detergent can then always be metered for hardness range I (= soft).

# Unit description

## Front view

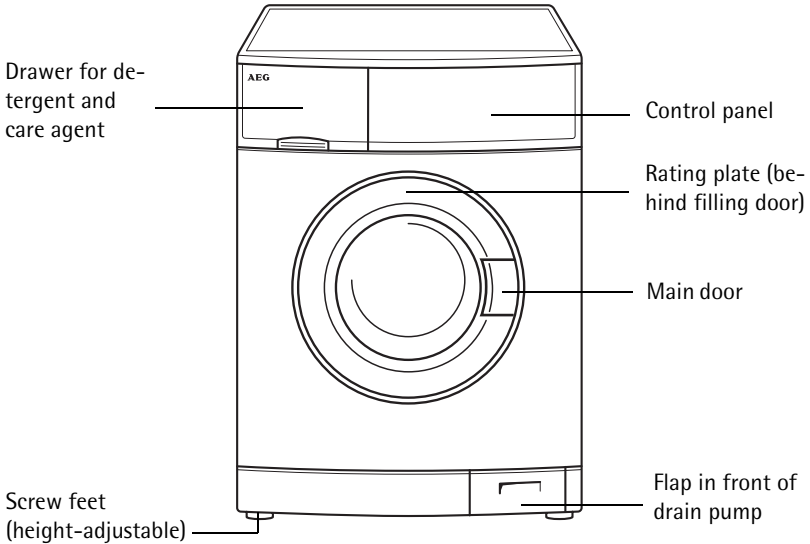

## Drawer for Detergent and Conditioners

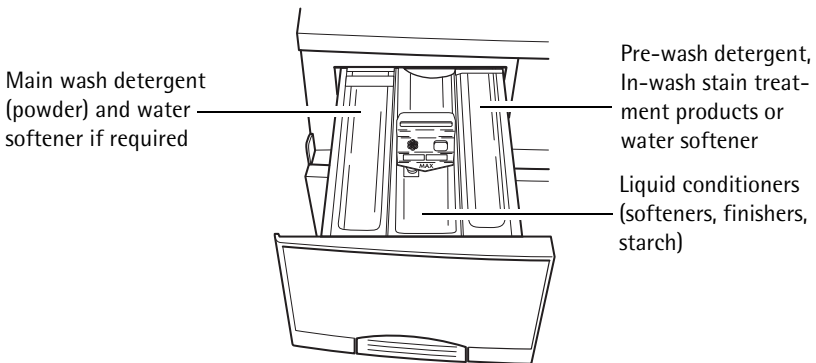

## Control Panel

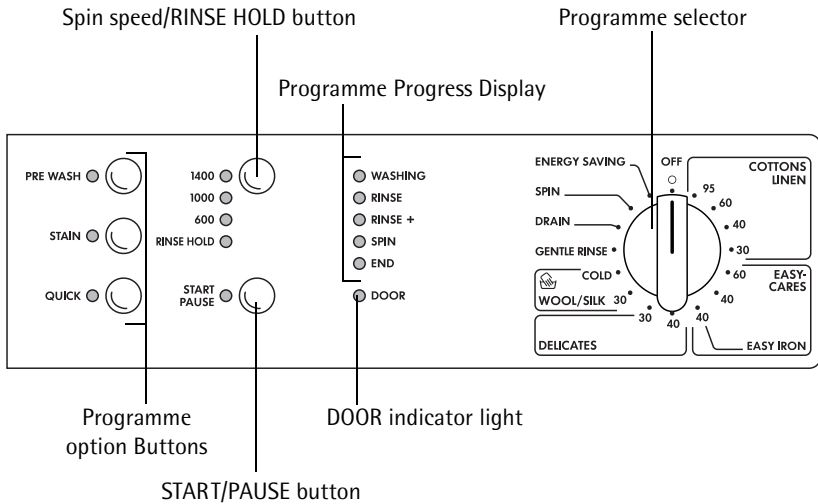

## Programme selector

The programme selector is used to select the wash cycle (for example, water level, drum movement, number of rinses, spin speed) and the water temperature according to the type of washing.

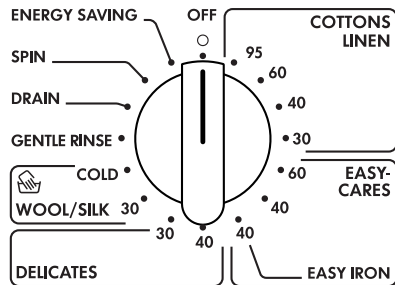

### OFF

- Switches the washing machine off - at all other positions the machine is on.
- To amend programme settings selected by mistake, turn the selector to OFF. This restores the original settings.

### COTTONS/LINEN

Main wash cycle for Cottons/Coloureds (cottons/linens) from 30 °C to 95 °C.

### **EASY-CARES**

Main wash cycle for easy-care fabrics (mixed fibres) at 40 °C or 60 °C.

**EASY IRON position:** main wash cycle at 40°C for easy-care fabrics which, after washing with this programme, require only light ironing or no ironing at all.

### **DELICATES**

Main wash cycle for Delicates at 30 °C or 40°C.

### **WOOL/SILK (Handwash)**

Main wash cycle (cold or 30 °C) for machine-washable or hand-washable woollen items and silk, carrying the symbol  (Handwash).

### **GENTLE RINSE**

Separate gentle rinse, for example to rinse hand-washed items (3 rinses, liquid conditioner washed in from  compartment, spin).

### **DRAIN**

Draining of the water after one rinse hold (without spinning).



The effect of Rinse Hold is that the washing is left to soak in the last rinse water, without spinning.

### **SPIN**

Draining of the water after Rinse Hold and Spin, or separate Spin for hand-washed Cottons/Linen.

### **ENERGY SAVING**

Energy and water saving wash at approx. 60 °C for lightly to normally soiled Cottons/Coloureds (cottons/linen) with an extended wash time (cannot be combined with the QUICK option).

## Programme Option Buttons

The programme option buttons are used to adapt the programme to suit the degree of soiling of the wash. The programme options are not needed for normally soiled washing.

The different functions can be combined together, depending on the programme.



### PRE-WASH

Warm pre-wash before the main wash, which follows automatically; intermediate spin in the COTTONS/LINEN and EASY CARES programme; no intermediate spin in the DELICATES programme.

### STAIN

For heavily soiled or stained washing. In-wash stain treatment products are washed in at the optimum time as the programme progresses. Can only be selected with wash temperatures of 40 °C and above, as stain treatment products are only effective at higher temperatures.

### QUICK

Shortened wash programme for lightly soiled washing.



With the WOOL/SILK  (Handwash) setting, the programme option buttons cannot be used. (Any buttons that are pressed have no effect.)

## Consumption Values and Programme Times

The following tables give the values for selected programmes under standard conditions. The tables do, however, give a helpful guide for normal household use.

Programme selector/Temperature	Load in kg	Water in litres	Energy in kWh	Time in minutes
COTTONS/LINEN 95	6	62	2.20	146
ENERGY SAVING 60 <sup>1)</sup>	6	58	1.12	135
COTTONS/LINEN 40	6	62	0.70	120
EASY-CARES 40	3	58	0.52	80
DELICATES 30	3	62	0.42	66
WOOL/SILK  (Handwash) 30	2	54	0.45	54

1) **Note:** Programme setting for testing in accordance with standard EN60 456. Actual consumption will vary from the indicated values depending on water pressure, water hardness, inlet water temperature, room temperature, type and quantity of washing, detergent used, variations in mains voltage and any option functions selected.

## Before the First Wash

-  **1.** Pull out the washing powder drawer slightly.
- 2.** Pour about 1 litre of water through the washing powder drawer into the washing machine. With the next program start, this will close the solution container and the eco-sluiice can function correctly.
- 3.** Run the washing cycle without washing (COTTONS/LINEN 95 °C, with half the amount of washing detergent). This removes residues left over from production on the drum and solution container.

# Prepare washing cycle

## Sort washing and prepare

- Sort the washing according to the care symbol and type (see "Washing types and care codes").
- Empty all pockets.
- Remove metal objects (paper clips, safety pins etc.).
- To prevent damage to the washing and tangled washing: Close zip fasteners, button bed and pillow covers closed, tie up loose strings e.g. of aprons.
- Turn articles with double layered textiles inside out (sleeping bags, anoraks etc.).
- In the case of knitted coloured textiles and also with wool and textiles with jewelry attached: turn inside out.
- Wash small and sensitive items (e.g. baby socks, tights and stockings, bras etc.) in a washing net, a cushion with a zip fastener or in larger socks.
- Handle curtains with particular care. Metal rollers or burred, plastic rollers must be removed or tied into a net or bag. We cannot accept liability for damage.
- Coloureds and white items must not be washed together in a washing cycle. This could discolour white washing or turn it grey.
- There is often excess dye in new, coloured items. It is best to wash such items separately the first time.
- Mix small and large items. This improves the washing effect and the washing is more favourably distributed during spinning.
- Fluff washing before placing into the washing machine.
- Do not place folded washing into the drum.
- Pay attention to the care instruction "wash separately" and "wash separately several times".

## Types of Washing and Care Symbols

Care symbols help you to choose the correct wash programme. Washing should be sorted by type, and according to their care symbols. The temperature indicated on the care symbol is the maximum wash temperature.

### **Cottons**

Cotton and linen items with this care symbol are not sensitive to machine washing or high temperatures. The COTTONS/LINEN programme is suitable for this type of washing.

### **Linen**

Cotton and linen items with this care symbol are not sensitive to machine washing. The COTTONS/LINEN programme is suitable for this type of washing.

### **Easy-Cares**

Materials such as fine cotton, wool-blend fabrics, viscose, and synthetics with these care symbols require gentler treatment. The EASY-CARES/EASY IRON programmes are suitable for this type of washing.

### **Delicates**

Materials such as layered fibres, microfibres, viscose, synthetics, and net curtains with this care symbol require particularly careful treatment. The DELICATES programme is suitable for this type of washing.

### **Wool/silk and especially sensitive materials**

Woollens, wool blends and silk with these care symbols are particularly sensitive to machine washing. The WOOL/SILK  (Handwash) programme is suitable for this type of washing.

**Important!** Materials with the care symbol  (Not machine-washable!) should not be washed in the washing machine.



## Washing Detergents and Care Agents

### Which washing detergent and care agent?

Use only washing detergents and care agents which are suitable for use in washing machines. Always follow the manufacturer's instructions.

### How much washing detergent and care agent?

The amount to be used depends on:

- the dirtiness of the washing
- the hardness category of the mains water supply
- the filling quantity



If the detergent manufacturer gives no details of the dosing quantities for minimum loads, add one third less for half loads and, in the case of very small loads and for EASY IRON, only half the amount of detergent recommended for a full load.

Refer to the detergent/care agent manufacturer's instructions on use and dosage.

## Water softener

For medium to high water hardness (hardness class II upwards), you should use softener. Refer to the manufacturer's instructions. Then always add the appropriate amount of detergent for hardness class I (= soft). The responsible water works will provide information on the local water hardness.



Since the water softener is rinsed in before the main detergent (water pre-softening), 80% of the stated quantity of softener shown on the package is sufficient.

### Water hardness details

Hardness class	Water hardness in °dH (German hardness scale)	Water hardness in mmol (millimol per litre)
I - soft	0 - 7	to 1.3
II - medium hard	7 - 14	1.3 - 2.5
III - hard	14 - 21	2.5 - 3.8
IV - very hard	greater than 21	greater than 3.8

# Running a washing cycle

## Brief instructions

A washing cycle consists of the following steps:



1. Open the door and load the washing.
2. Close the door.
3. Add detergent/conditioner.
4. Set the appropriate washing programme:
  - Set the programme and temperature using the programme selector
  - Set programme options as required.
5. Change the Spin Speed /select RINSE HOLD as necessary.
6. Start the washing programme by pressing the START/PAUSE button.

### **After the washing programme has ended:**

**Important!** If the washing cycle has ended with a Rinse Hold, select DRAIN or SPIN before opening the door.

7. Open the door and remove the washing.  
The door can be opened after the DOOR light goes off and the END light has come on.
8. To switch off the washing machine: turn the programme selector to OFF.

## Opening and closing the door

-  To open: pull the door by the handle.
-  To close: push the door firmly shut.

When the machine is switched on, the DOOR light and the START/PAUSE light indicate whether the door can be opened





DOOR indicator	START/PAUSE indicator	Can the door be opened?
flashes	flashes	yes, after about 2 minutes
lit	lit	no <sup>1)</sup>
is off	flashes	yes

1) Door is locked due to high water level or high temperature.

-  If the END light flashes 4 times and an acoustic signal is emitted 4 times, it means there was an attempt to start a wash programme without closing the door properly. If this happens, push the door firmly shut and start the wash programme again.

## Add the washing

-  For the maximum filling quantities, see the "Program tables". See "Sort and prepare washing" for information on correctly preparing the washing.

-  1. Sort and prepare the washing according to type.
- 2. Open the filling door: Pull on the handle of the filling door.
- 3. Fill with washing.
 

Important! When closing the door, make sure no items of washing get stuck! This could damage textiles and the unit.
- 4. Close the filling door securely.

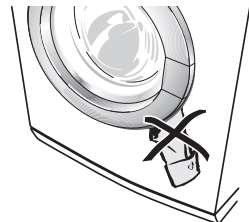

## Adding detergent/conditioners

**i** For instructions concerning detergent and conditioners, see Section "Washing Detergents and Care Agents".

- 1.** Open the detergent dispenser drawer: press the flap on the drawer so as to be able to grasp the handle (1), and pull out the drawer (2).

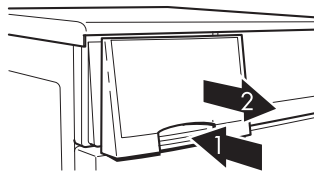

- 2.** Add the detergent/conditioners.

### Compartment for main wash powder detergents

(If you use a water softener and need the right-hand compartment for the pre-wash/stain treatment product, add the water softener to the left-hand compartment with the main wash detergent.)

### Compartment for liquid conditioners (softeners, finishers, starch)

**Important!** Do not fill the compartment past the MAX mark. If required, dilute concentrated fluids up to the MAX mark, dissolve powdered starches.

**Note:** A small amount of water remaining in the liquid conditioner compartment is normal and does not affect rinse results.

### Compartment for Pre-wash detergent or in-wash stain treatment products

(for the PRE WASH or STAIN programme options only)  
or for water softener

- 3.** Push the drawer in fully.

**i** **If using liquid detergents/tablets:**

Add liquid detergent or tablets using the dosage container provided by the detergent manufacturer. Follow the instructions on the detergent packaging.

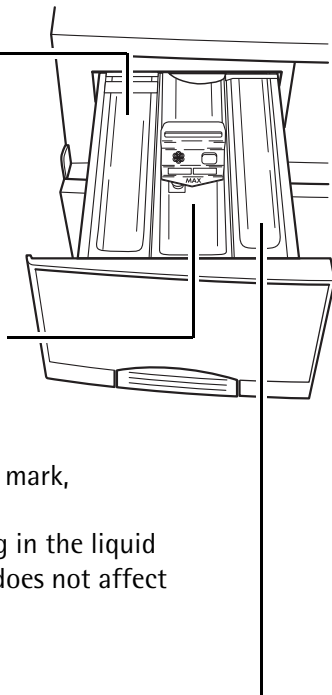

## Setting the washing programme

**i** For the appropriate programme, temperature and possible programme options suitable for any type of washing, see "Programme Tables".

**1.** Select the desired wash programme and temperature with the programme selector.

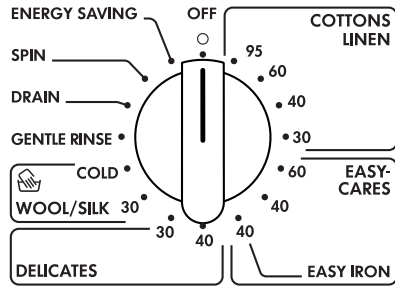

**2.** If required, select the appropriate programme option(s):

The indicator of the selected programme option illuminates.

- To change the selection, press another button.
- To cancel a selection, press the button again.



## Changing Spin Speed/selecting RINSE HOLD

**1.** To change the Spin Speed for the final rinse or select RINSE HOLD:

Keep pressing the Spin Speed/RINSE HOLD button until the indicator light for the desired speed (or RINSE HOLD) comes on.

If RINSE HOLD is selected, the washing is left to soak in the last rinse water, without spinning.

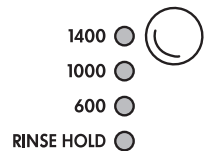

**i** If the Spin Speed is not changed, the final spin is automatically adjusted to suit the washing programme:

- |                        |                             |
|------------------------|-----------------------------|
| - COTTONS/LINEN        | 1400 revolutions per minute |
| - ENERGY SAVING        | 1400 revolutions per minute |
| - EASY-CARES/EASY IRON | 1000 revolutions per minute |
| - DELICATES            | 1000 revolutions per minute |
| - WOOL/SILK            | 1000 revolutions per minute |

The speed of intermediate spins depends on the selected programme and cannot be changed.

## Starting the Wash Programme

1. Check that the water tap is open.
2. To start the wash programme, press the START/PAUSE button. The wash programme starts.



- i** If the END light flashes 4 times and an acoustic signal is emitted 4 times when the START/PAUSE button is pressed, the door is not closed properly. In this case, push the door in firmly, and press START/PAUSE again.

## Programme Progress

### Programme Progress Display

Prior to the start, the programme steps chosen are displayed by the programme progress display. During the wash programme, the current programme step is displayed.



## Changing the washing programme

### Changing or cancelling the programme

1. Press the START/PAUSE button.
2. Turn the programme selector to OFF. The washing programme is cancelled.
3. Set another washing programme, if required. Otherwise, turn the programme selector to DRAIN or SPIN and press the START/PAUSE button. (The water is drained or the washing is spun.)

- i** The washing programme can be temporarily interrupted at any time by pressing the START/PAUSE button. It is then re-started by pressing the button again. A washing programme can only be changed after the programme selector has been turned to OFF.

### Selecting a programme option

The programme options QUICK or STAIN can still be selected after the programme has started.

1. Press the START/PAUSE button.
2. Press the QUICK or STAIN button.
3. Press the START/PAUSE button. The washing programme continues.

### Changing the Spin Speed

The Spin Speed can still be changed or RINSE HOLD set, while the programme is running.

1. Press the START/PAUSE button.
2. Change the spin speed with the Spin Speed/RINSE HOLD button.
3. Press the START/PAUSE button again. The washing programme continues.

### Washing cycle complete/removing the washing

Once a washing programme cycle has come to an end, END illuminates on the Programme Progress Display.

If RINSE HOLD was selected, the indicator lights beside DOOR and END come on.

1. After a Rinse Hold, the water must first be drained:
  - Either turn the programme selector to OFF, then turn to DRAIN and press the START/PAUSE button (the water is drained without spinning),
  - or
  - turn the programme selector to OFF, then turn to SPIN and press the START/PAUSE button (the water is drained and the washing given a spin. The spin speed can also be changed during the spin cycle).When this stage of the programme is completed, the END light comes on.

2. Open the door.

The door can be opened after the DOOR light goes off and the END light has come on.













3. Remove the washing.
4. Turn the programme selector to OFF.
5. Close the water tap.
6. After the washing cycle is completed, pull out the detergent dispenser drawer slightly, to allow it to dry. Leave the door slightly open, to air the inside of the washing machine.

**Important!** If the washing machine is not used for a long time: Close the water tap and disconnect the washing machine from the electricity mains.

# Programme Tables

## Washing

The tables do not show all the possible settings, only those most likely to be selected for everyday purposes.

Type of washing, Care symbol	Max. Load <sup>1)</sup> (Dry weight) <sup>2)</sup>	Programme selector Temperature [in °C]	Possible programme options
Cottons 	6 kg	COTTONS/LINEN 95	PRE WASH or STAIN QUICK
Cottons/Coloureds <sup>3)</sup>  	6 kg	ENERGY SAVING	PRE WASH or STAIN
Coloureds  	6 kg	COTTONS/LINEN 30 to 60	PRE WASH or STAIN <sup>4)</sup> QUICK
Easy-cares  	3 kg	EASY-CARES 40, 60	PRE WASH or STAIN QUICK
	1 kg	EASY IRON <sup>5)</sup> 40	
Delicates 	3 kg (or 15-20m <sup>2</sup> net curtains)	DELICATES 30, 40	PRE WASH QUICK
Wool/Silk (Handwash)   	2 kg	 WOOL/SILK COLD, 30	

1) The load amount inquiry operates in accordance with the EN 60456 standard load.

2) A 10 litre bucket holds around 2.5 kg of dry clothes (cotton).

3) Programme settings for testing in accordance with or in support of EN 60 456 and IEC 60 456 are described in the chapter "Consumption Values and Programme Times".

4) A temperature of at least 40 °C is needed for the STAIN programme, to make stain treatment products effective.

5) Creasing can largely be avoided, but only by keeping wash loads under 1 kg, About 1 kg of dry clothes is equivalent to between 5 and 7 easy-care men's shirts.



## Separate Rinsing

Type of washing	Max. load (dry weight)	Programme selector
Cottons/Coloureds	6kg	GENTLE RINSE
Easy-Cares/Delicates <sup>1)</sup>	3kg	

1) Reduce spin speed

## Separate Spinning

Type of washing	Max. load (dry weight)	Programme selector
Cottons/Coloureds	6kg	SPIN
Easy-Cares <sup>1)</sup>	3kg	
Delicates <sup>1)</sup>	3kg	
Wool/Silk (Handwash) <sup>1)</sup>	2kg	

1) Reduce spin speed.

# Cleaning and Care

## Control panel

Important! Do not use any furniture cleaning agents or aggressive cleaning agents in order to clean panel and control parts.

- ☞ Wipe control panels with a damp cloth. When doing so, use warm water.

## Detergent Drawer

The detergent drawer should be cleaned from time to time.

- ☞ 1. Pull the detergent drawer out as far as it will go.
- 2. Remove the detergent drawer by pulling sharply.
- 3. Take the conditioner insert out of the middle compartment.
- 4. Clean the conditioner insert under running water.

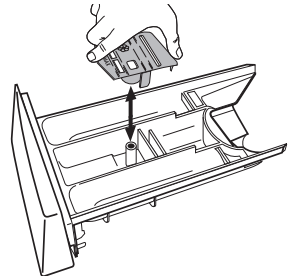

- 5. Clean the compartments with warm water from the rear side. It is best to use a flat brush.

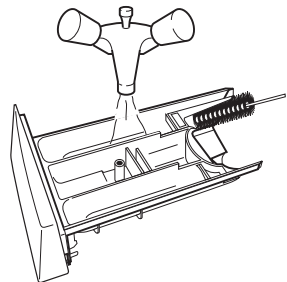

- 6. Push on the conditioner insert as far as it will go so that it is securely in place.

7. Use a brush to clean the entire rinsing-in section of the washing machine, particularly also the nozzles on the top side of the rinsing-in chamber.

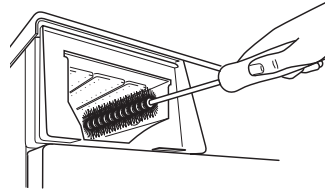

8. Set the detergent drawer into the guide tracks and push in.

## Washing Drum

The washing drum is made of stainless steel. Rusting foreign bodies in the washing can cause rust deposits on the drum.

**Important!** Do not clean the stainless steel drum with decalcifying agents containing acids, scouring agents containing chlorine or iron, or steel wool. Our Customer Service can provide suitable agents.

- ☞ Remove any rust deposits on the drum using a stainless steel cleaning agent.

## Main door

- ☞ Check on a regular basis to see if deposits or foreign objects are present in or at the rubber sleeve behind the door, and remove.

# What to do if ...

## Remedying Faults

In the event of a fault, try to solve the problem yourself with the aid of the information provided here. If you call Customer Service to deal with one of the faults listed here or to remedy an operating fault, the customer service technician's visit will not be free of charge, even during the warranty period.

Problem	Possible cause	Remedy
The washing machine does not work.	The mains plug is not inserted.	Insert the mains plug.
	The house fuse has blown.	Replace the fuse.
	The door is not closed properly.	Close the door. There should be an audible click.
	The START/PAUSE button was not pressed for long enough.	Press and hold the START/PAUSE button until the programme starts.
The door cannot be closed.	The child safety feature is engaged.	Release child safety feature (see Section "Child Safety Feature").
The END light flashes 4 times and an acoustic signal is emitted 4 times	The door is not closed properly.	Close the door properly. Start the programme again.
The END light flashes once an acoustic signal is emitted once.	The water tap is closed.	Open the water tap. Start the programme again.
	The filter in the socket of the inlet hose is blocked.	Close the water tap. Disconnect the hose from the water tap, remove the filter and clean under running water.
	Water tap is blocked with limescale or is faulty.	Check the water tap and have it repaired if necessary.

Problem	Possible cause	Remedy
The END light flashes 8 times and an acoustic signal is emitted 8 times.	The programme selector has not clicked into place correctly.	First turn the programme selector to OFF, then set the desired programme to the exact position.
The washing machine vibrates when operating, or is noisy.	Transit packaging was not removed.	Remove the transit packaging as described in the Installation and Connection instructions.
	The machine is not level.	Adjust the feet according to the Installation and Connection instructions.
	There is very little washing in the drum (for example one dressing gown).	This does not affect the operation of the machine.
	Water could not be fully drained out before spinning because the drain hose is kinked or the water pump is blocked.	Check the drain hose and remove any kinks if necessary or clean the water pump and if necessary remove any foreign bodies from the pump housing.
Excessive foaming during the main wash.	Probably too much detergent has been used	It may be necessary to reduce the amount of detergent used. Follow the detergent manufacturer's recommendations.

Problem	Possible cause	Remedy
Water leaks out of the washing machine.	The screw connection of the inlet hose is leaking.	Tighten the inlet hose screw connection.
	The drainage hose is leaking.	Check the drainage hose and replace if necessary.
	The drain pump cover is not correctly closed.	Close the cover correctly.
	Washing is caught in the door.	Stop the programme, remove the washing caught in the door. Restart the programme.
	The emergency emptying hose is not correctly closed or is leaking.	Close the emergency emptying hose (see Section "Carry out emergency emptying"). Call your local Service Force Centre if the emergency emptying hose is leaking.
Fabric softener was not rinsed in, the  compartment is filled with water.	The insert in the conditioner compartment is not correctly attached or is blocked.	Clean the detergent dispenser drawer and attach the conditioner insert correctly.
Washing is heavily creased.	Probably too much washing has been put in the drum.	Pay attention to the maximum load quantity (see Programme Tables). In the case of easy-care fabrics, select the EASY IRON programme.
The washing has not been spun as dry as usual.	The washing was not able to be distributed evenly in the drum prior to spinning.	Always load the drum as full as possible with a combination of large and small items.
Washing is not thoroughly spun, water remains visible in the drum. The END light flashes twice, an acoustic signal is emitted twice.	The drain hose is kinked.	Remove the kink.
	The maximum pump height (outlet height 1 m from the base of the appliance) is exceeded.	Contact your local Service Force Centre. For pumping heights over 1 m a conversion kit is available as a special accessory.
	The drain pump is blocked.	Switch off the machine and disconnect the mains plug. Clean the drain pump.
	For siphon attachments: the siphon is blocked.	Clean the siphon.

Problem	Possible cause	Remedy
<p>The door cannot be opened when the washing machine is on. START/PAUSE and DOOR lights come on.</p>	<p>Door is locked due to high water level, or high temperature.</p>	<p>Wait until the programme has ended, the DOOR light goes off and the END light is lit.</p>
		<p>If it is necessary to open the door immediately, Turn the programme selector to OFF; then turn it to DRAIN. Press the START/PAUSE button. When the water has been pumped out, the door can be opened.</p>
<p>Power failure during a wash programme (all indicator lights are off).</p>	<p>The failure may be caused by a blown house fuse or by a mains supply fault into the house. (For safety reasons, the door remains locked for around 2 minutes.)</p>	<p>The programme continues when power is restored. If washing has to be taken out during a power cut: Turn the control knob to OFF. Carry out emergency emptying (see Section "Carry out emergency emptying"). After about 2 minutes, the door can be opened by pulling on the handle.</p>
<p>Remnants of detergent are building up in the detergent drawer.</p>	<p>The water tap is not fully opened.</p>	<p>Open the water tap fully.</p>
	<p>The inlet hose filter in the inlet coupling of the inlet hose at the tap is blocked.</p>	<p>Close the water tap. Unscrew the inlet hose from the water tap and from the machine. Clean the filter.</p>
<p>The rinse water is cloudy.</p>	<p>The cause is probably a detergent with a high silicate content.</p>	<p>This has no negative effects on rinse results; use a liquid detergent if necessary.</p>
<p>When pressing a programme option button, the corresponding indicator does not light up.</p>	<p>The selected programme option cannot be combined with the set programme.</p>	<p>Make another selection.</p>

## **If the washing results are not satisfactory**

### **If the washing has turned grey and if limescale is deposited in the drum, then**

- Too little detergent was used.
- The wrong detergent was used.
- Special soiling was not pre-treated.
- Program or temperature not set correctly.
- If multi-component detergents are used, the individual components were not used in the correct ratio.

### **If there are still grey spots on the washing,**

- Washing soiled with ointments, grease or oils was washed with too little detergent.
- Too lower temperature was used for washing.
- A frequent cause is that softener - particularly that in concentrated form - has reached the washing. Wash out such spots quickly and use the softener concerned carefully.

### **If at the end of the last rinse foam is still visible**

- Modern detergents can also cause foam in the last rinse. However, the washing is still sufficiently rinsed.

### **If there are white remnants on the washing**

- These are insoluble components of modern detergents. They are not the result of an insufficient rinsing effect. Shake or brush out the washing. In future, perhaps you should turn the washing inside out before washing it. Examine your choice of detergent and if necessary use liquid detergent.



## Carrying out emergency drainage

- If the washing machine no longer pumps off the washing solution, emergency drainage must be performed.
- If the washing machine is in a room where there is a risk of frost, emergency drainage must be performed if there is a possibility of frost.

In addition: unscrew the inlet hose from the water tap and place it on the floor. Empty the drainage hose.



**Warning!** Switch off the washing machine before performing emergency drainage and pull out the mains plug.

**Caution!** The washing solution escaping from the emergency drainage hose may be hot. There is a risk of scalding! Allow the washing solution to cool down before performing emergency drainage.

1. Place a flat collecting vessel in order to collect the washing solution which is draining off.
2. Fold open the flap in the right section of the base outwards and pull it off.

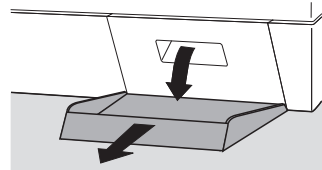

3. Remove the emergency drainage hose from its holder.

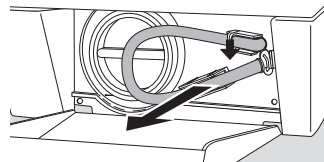

4. Place the container under the hose.
5. Detach the plug of the emergency drainage hose by turning it anticlockwise and pull it out.

The washing solution runs out. Depending on the amount of solution, it may be necessary to empty the collecting vessel several times. To do this, close the emergency drainage hose temporarily with the plug.

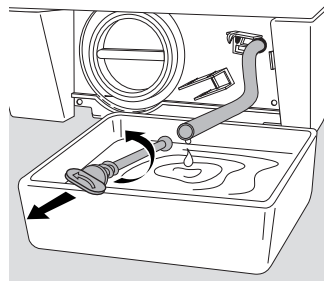

**When the water is completely drained:**

6. Push the plug securely into the emergency drainage hose and turn it clockwise to secure it.
7. Replace the emergency drainage hose in its holder.
8. Put on the flap and close.

## Drain pump

The drain pump is maintenance-free. The cover of the drain pump is required to be opened only in the event of a malfunction when no more water is being pumped out, e.g. if the pump wheel is blocked. Before loading the machine, please always ensure that there are no foreign objects present in the pockets or inbetween the items to be washed. Paper clips, nails etc. which may find their way into the washing machine along with the washing will remain in the drain pump housing (foreign objects are protected by the pump wheel).

To restart the drain pump when it is blocked, please proceed as follows:



**Warning!** Switch off the washing machine and remove the mains plug before cleaning the drain pump!

1. First carry out an emergency emptying procedure (see section "Carrying out emergency emptying").
2. Place a cloth on the floor in front of the cover of the drain pump. Residual water may run out.
3. Unscrew the drain pump cover in an anti-clockwise motion and pull it out.

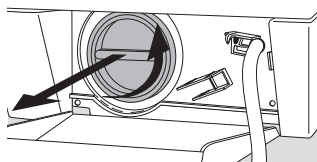

4. Remove any foreign objects and fabric lint from the pump housing and from the pump wheel.

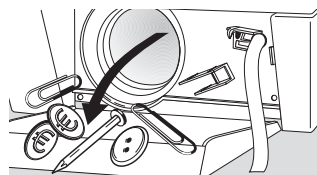

5. Check that you are able to turn the pump wheel at the very rear of the pump housing. (If the wheel rotates with a jerky motion, this is normal.) If you cannot turn the pump wheel, please contact customer service.

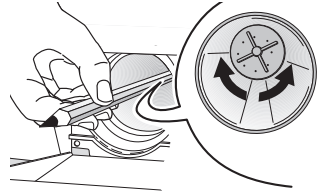

6. Replace the pump cover. Laterally insert the webs on the cover into the guide slots and securely screw on the cover in a clockwise motion.

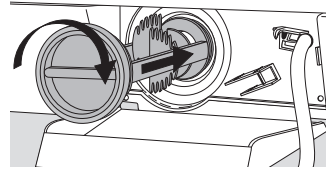

7. Close the emergency emptying hose and place it in the holder.

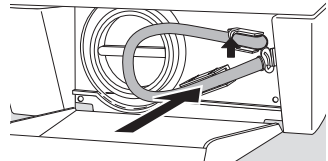

8. Close the flap.

## Additional rinse cycles (RINSE+)

The washing machine is set for very economical water consumption. However, for people who suffer from allergies, it can be helpful to rinse with extra water.

-  If RINSE+ is set, two extra rinse cycles are added to the COTTONS/LINEN, EASY-CARES/EASY IRON and DELICATES programmes. When the machine is delivered, no additional rinse cycles are set.

### To set additional rinse cycles:

1. Turn programme knob to COTTONS/LINEN, EASY-CARES/EASY IRON or DELICATES (any temperature).
2. Press and hold the PRE WASH and QUICK buttons at the same time for at least 2 seconds. RINSE and RINSE+ light up on the programme progress display. The additional rinse cycles are now set. They remain stored until cancelled again.

-  Additional rinse cycles increase both water consumption and programme duration.

### To cancel the additional rinse cycles:

1. Turn the programme knob to COTTONS/LINEN, EASY-CARES/EASY IRON or DELICATES again.
2. Press and hold the PRE WASH and QUICK buttons at the same time for at least 2 seconds. RINSE+ lights up on the programme progress display. The additional rinse cycles are now cancelled.

## Child Safety Feature

If the child safety feature is set, the filling door can no longer be closed and no washing program can be started.

### Setting the child safety feature



Use a coin to turn the rotary knob on the inside of the filling door clockwise as far as it will go.



**Warning!** The rotary knob must not be in a vertical position after adjustment, otherwise the child safety feature is not active. The rotary knob must project as shown in the diagram

### Cancelling the child safety feature



Turn the rotary knob anticlockwise as far as it will go.

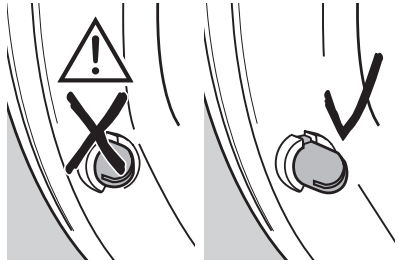
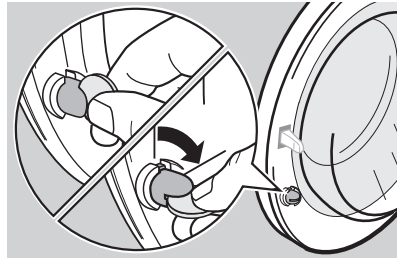

# Installation and connection instructions

## Installation Safety Precautions

- Do not tilt the washing machine onto its front or onto its right side (viewed from the front). Electronic components can get wet.
- Check the washing machine for transport damages. A damaged unit must never be put into operation under any circumstances. In the event of damage, please contact your supplier.
- Ensure that all parts of the transport safeguard are removed and that the unit is splash protected, see "Removing transport safeguard". Otherwise, the units or neighbouring furniture can be damaged when spinning.
- Always insert the plug into a correctly installed earthed socket.
- In the case of permanent connection: A permanent connection may only be made by an authorised specialist.
- Before putting the machine into operation, ensure that the mains voltage and current type shown on the unit's rating plate correspond with those at the place where the machine is being installed. The fuse rating is also found on the rating plate.
- Should work be carried out on the water supply installations in order to allow the machine to be connected properly to the water supply, this work must be carried out by an authorised installer.
- Should work be carried out on the mains supply in order to allow the machine to be connected properly to the electricity supply, this work must be carried out by an authorised electrician.
- The mains lead may only be replaced by the customer service or by an authorised electrician.

# Installation of the appliance

**i** Washing machines with curved panels are not suitable for installing under units.

## Transporting the appliance

- Do not place the washing machine on its front or on its right side (viewed from the front). Otherwise, electrical components can get wet.
- Never transport the unit without the transport safeguard. Do not remove the transport safeguard until the appliance is at the installation location. Transporting the unit without the transport safeguard can damage it.
- Lift the appliance neither by an open filling door nor by the base.
- When transporting the unit with a sack trolley: Attach the sack trolley only at the side.

## Remove transport packaging

**Important!** It is essential to remove the transport packaging before putting the appliance into operation. Keep all parts of the transport packaging in a safe place for future use.

- 1.** Open both hose holders on the appliance's rear side and remove the hoses and mains cable.

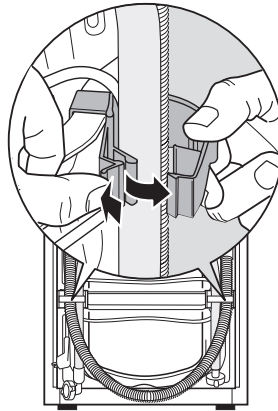

- 2.** Pull both hose holders off the appliance with a strong pull.

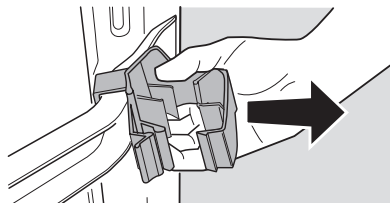

**i** The special spanner (A) and the caps (B) (2 each) and (C) (1 each) are supplied with it.

3. Remove the screw D, including the compression spring with the special spanner A.

4. Cover the hole with the cap C.

**Important!** When fitting the plastic caps, press until they snap into the rear panel securely.

5. Remove the two screws (E) with the special spanner (A).

6. Remove the 4 screws (F).

7. Remove the transit bar (G).

8. Screw the 4 screws (F) back in for safe keeping.

9. Close the 2 large holes with the caps (B).

**Important!** When fitting the plastic caps (B), press until they snap into the rear panel securely.

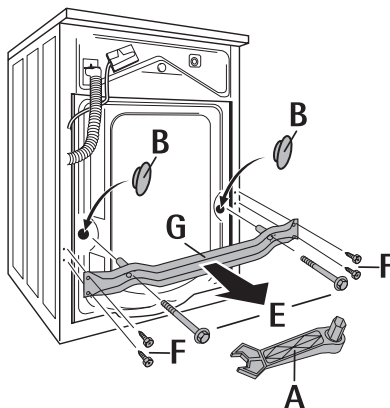
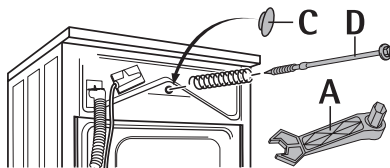



## Prepare the installation place

- The installation surface must be clean and dry, free of floor polish residues and other greasy coatings so that the unit does not slip away. Do not use lubricants as a sliding aid.
- Installation on a high-veil carpet or floor tiles with soft sponge backs is not recommended because the standing safety of the appliance is then no longer ensured.
- By installation surfaces with small-format tiles, lay a conventional rubber mat underneath.
- Minor unevenness of the floor surface should never be levelled out by laying pieces of wood, card or similar materials, but rather should always be compensated for by adjusting the screw feet.
- If, for space reasons, it is not possible to avoid setting up the unit directly next to a gas or coal-fired cooker: install a thermal insulation panel between the cooker and washing machine (85 x 57cm) which must have an aluminium film on the side against the cooker.
- The washing machine must not be set up in a room where there is a danger of frost. Frost hazard!
- Flexible feed and drain tubings may not be crinkled or squeezed.

## Installation on a concrete base

If the unit is set up on a concrete base, for safety reasons it is essential to fit stand plates in which the washing machine is adjusted. The stand plates are available from Customer Service under the spare parts number 645 425 058.

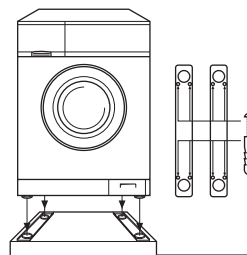

## Installation on vibrating floors

Where the floor vibrates, particularly in the case of wooden beam floors with pliable boards, securely screw a water-resistant wooden panel at least 15mm thick onto at least 2 floor planks. If possible, set up the unit in the corner of a room, as the wooden floor is optimally restrained there and is therefore least likely to be subject to resonance vibrations.

## Compensate for floor unevenness

Floor unevenness can be compensated for and the height can be corrected with the four adjustable screw feet. The height can be adjusted in the range +10 .. -5mm.

To adjust the feet use the special spanner supplied for removing the transport braces.

-  1. Slide the special key firmly onto the hexagon head of the threaded foot as far as it will go.
2. Adjust the screw feet so that the unit is horizontal and stable. The unit must not wobble over when loaded.
3. If necessary, check the setting with a spirit level.

**Important!** Minor unevenness of the floor surface should never be levelled out by laying pieces of wood, card or similar materials, but rather should always be compensated for by adjusting the adjustable feet.

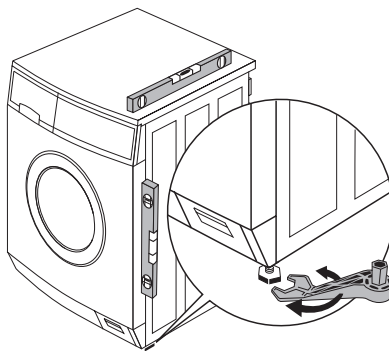



## Water inflow

A pressure hose of 1.35m in length is supplied.

If a longer inflow hose is required, only a VDE-approved, complete set of hoses with fitted hose screw connections offered by our Customer Service is permissible.

- Hose sets in lengths of 2.2m, 3.5m and 5m are available for washing machines without Aqua-Control.
- Hose sets in lengths of 2.0m, 2.9m and 3.5m are available for washing machines with Aqua-Control.

**Important!** Never cut into pieces in order to extend the hoses!



Sealing rings are supplied either in the plastic nuts of the hose screw connection or in the enclosed pack. Do not use other seals!



1. Connect the hose with the angled connection to the machine.

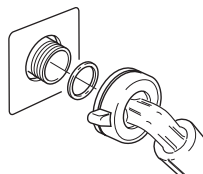

**Important!**

- Do not lay the inlet hose vertically downwards, instead run it to the right or left as shown in the diagram.
- Tighten the hose screw connection only by hand.

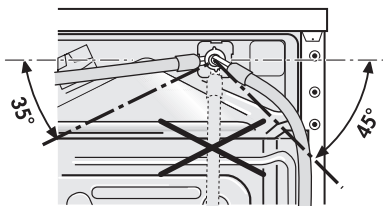

2. Connect the hose with the straight connection to a water valve with a screw thread R 3/4 (inches).

**Important!** Only tighten the screw connection manually.

3. By slowly opening the water valve before putting the washing machine into operation, check that the connection is free of leaks.

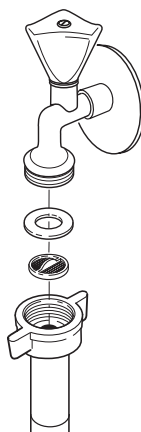

## Water drain

The drainage hose can either be connected to a siphon or hung in a wash basin or discharge basin or a bath tub.

Only original hoses may be used for extensions (max. 3m laid on the floor and then up to 80cm high). Customer Service stocks drainage hoses in lengths of 2.7 and 4m.

**Important!** It is essential to lay the drainage hose without kinks.

### Water drain-off inside a siphon

The grommet on the hose end fits all standard siphon types.



Secure the connection between the grommet and siphon with a hose clamp.

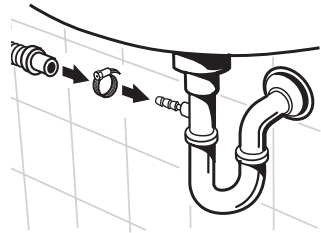

### Water drain-off inside a basin

#### Important!

- Small basins are not suitable for drainage. Water could overflow!
- The end of the drainage hose must not be submerged in the pumped-out water. Otherwise, the water could be sucked back into the unit.
- When hanging in a wash basin or a bath tub, the drainage hose must be secured with the supplied attachable bend to prevent it slipping. The back-surge force of the escaping water could otherwise force the hose out of the basin.



Tie the bend to the tap or the wall using a piece of string.

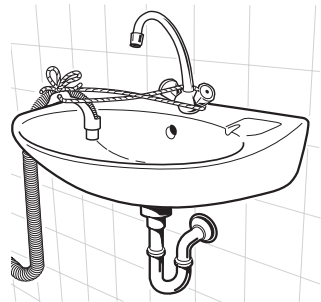
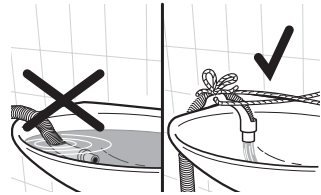

## Delivery heads over 1m

To pump off the washing / rinsing solution, every washing machine has a drain pump which carries liquids up to a height of 1m via the drainage hose, calculated from the machine's standing surface.

Please contact Customer Service for delivery heads of over 1m.

## Technical data

Adjustment possibility  
Filling quantity (program-dependent)  
Area of use  
Drum speed, spinning  
Water pressure

Approx. +10 / -5mm  
max. 6kg  
Domestic  
See rating plate  
1-10 bar (= 10 - 100 N/cm<sup>2</sup>  
= 0.1 - 1.0 Mpa)

## Dimensions

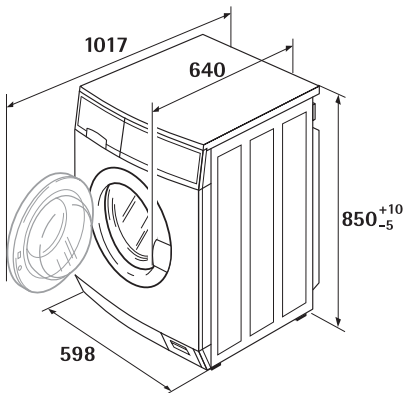

(dimensions in mm)

# Warranty conditions / Customer service centres

## Weitere Kundendienststellen im Ausland

In diesen Ländern gelten die Garantiebedingungen der örtlichen Partner. Diese können dort eingesehen werden.

## Further after-sales service agencies overseas

In these countries our AEG agents' own guarantee conditions are applicable. Please obtain further details direct.

## Autres agences étrangères assurant le service après-vente

Dans ces pays, les conditions de garantie des concessionnaires de la région sont valables. Vous pouvez les consulter sur place.

## Otros puntos de Postventa en el extranjero

En estos países rigen las condiciones de nuestros representantes locales. las cuales pueden ser consultadas allí mismo.

## Ulteriori uffici del servizio tecnico assistenza clienti all'estero

In questi paesi sono valide le condizioni di garanzia dei partner locali. Queste condizioni possono essere esaminate sul luogo.

## Serviços de assistência técnica no estrangeiro

Nestes países são válidas as condições de garantia dos concessionários locais, podendo aí ser consultadas.

## További vevőszolgálati irodák külföldön

Ezekben az országokban a mi AEG vevőszolgálatainknál saját jótállási feltételek alkalmazhatók. A további adatokat kérjük közvetlenül szerezzék be.

## Servisne službe

Na garancijskem listu boste našli seznam pooblaščenih servisnih služb AEG.

### U.A.E. Abu Dhabi

Universal Trading Company  
P.O. Box 43 99  
Tel.: 335331

### Jordan

Jordan Household  
Supply Co. Ltd.  
P.O. Box 3/68  
Amman/Tel.: 69 70 50

### Malta

ITC  
International Trading Company  
White House Building  
Mountbatte Street  
Blata L-Bajda/Tel.: 220644

### Egypt

Middle East Commercial  
Center  
P.O. Box 19  
Kairo-Heliopolis  
Tel.: 29917/31634

### Kanada

EURO-LINE Appliances  
2150 Winston PARK Drive 20  
Oakville, Ontario L6H 5V1  
Tel.: 905 829 3980  
Fax: 905 829 3985

### Mauritius

Happy World Centre Ltd.  
P.O. 7 54  
1 Chausee Street  
Port Louis  
Tel.: 25355

**Australia**

ANDI-Co Pty. Ltd  
9 Kingston Town Close  
Oakleigh VIC 3166  
Tel.: (03) 9569 1235  
Fax: (03) 9569 1450

**Bahrain/Arabian Gulf**

A.A. Zayani & Sons  
P.O. Box 9 32  
Bahrain  
Tel.: 261060

**Bulgaria**

Electrolux Bulgaria E.O.O.D.  
91 Levski Blvd.  
1000 Sofia  
Tel.: 2 806676  
Fax. 2 980 5276

**Cyprus**

Hadjikyrlakos & Sons Ltd.  
Prodromou 121  
P.O. Box 21587  
Nicosia 1511  
Service Telephones:  
Nicosia 02 481226  
Limassol 05 562182  
Larnaca 04 633929  
Paphos 06 932 699

**Estonia**

Electrolux Estonia Ltd.  
Mustamäe tee 24  
EE0006 Tallinn  
Tel.: (372) 6 650 090  
Fax: (372) 6 650 092

**Hongkong**

Wo Kee Services Ltd.  
585-609 Castle Peak Road  
Kwai Chung N.T.  
Hongkong  
Tel.: 2494 4000

**Korea (South)**

Core Incorp.  
3/F Chewoo Bldg.  
200 Nonhyun-Dong  
Kangnam-Ku  
Seoul  
Telefon 82 2 549 89 61

**Croatia**

Electrolux D.O.O.  
Suplova 7  
10000 Zagreb  
Tel.: 1 61 19512  
Fax: 1 61 19513

**Kuwait/Arabian Gulf**

Ali Al-Ghanim Est.  
P.O. Box 10 83  
Tel.: 5322463  
Fax: 5242114

**Lebanon**

Adib & Assaferi  
P.O. Box 539  
Tripoli

**Latavia**

Electrolux Latavia Ltd.  
Terlaton Street 42/44  
1011 Riga  
Tel.: 371 2 297821  
Fax: 371 2 821286

**Lthuania**

Electrolux Lthuania  
Verkui 29  
2600 Vilnius  
Tel.: 372 272 3326  
Fax: 372 272 3366

**Namibia**

AEG NAMIBIA (PTY) LIM-  
ITED-Jeppe Street  
Northern Industrial Area  
Windhoek  
Tel.: (061) 21-6082/4  
Fax: (061) 217838

**New Zealand**

Euro-Life New Zealand Ltd.  
Privat Bag  
58 Symonds Street  
Auckland  
Tel.: (09) 525 2222

**Nouvelle Caledonie**

Socometra N.C.  
B.P. 483  
Nouman  
Tel.: 275444

**Oman**

Moshin Haider Darwish  
P.O. Box 1 35  
Muscat  
Tel.: 703743

**Poland**

Electrolux Poland Sp. zo.o.  
ul. Domaniewska 41  
02-034 Warszawa  
tel.: 022 874 33 33  
fax: 022 874 33 00

**Russia**

Electrolux Russia Ltd.  
16 Olympiysky prospekt  
129090 Moscow  
Tel.: (095) 937 7837  
Fax: (095) 926 5513



**Israel**

Electricity & Electronic  
Services-Evis LTD.  
19 Hataasia st.  
Raanana,  
Industrial area 43654  
Tel: 972-9-7448118  
Fax: 972-9-7603618  
e-mail: evis@evis.co.il

**Malaysia**

Arzbergh Engineering  
No. 49A/B, Jalan Petaling  
Utama 7  
4600 Petaling Jaya  
Tel.: 3 795 1084  
Fax: 3 795 1082

**Saudi Arabia**

Alia Trading Corporation  
P.O. Box 4101  
King Abdul Aziz Street  
Riyadh  
Tel.: 4645977  
Al Nahas Est.  
Musaidia Market I  
P.O. Box 1 15 29  
Jeddah  
Tel.: 6606852

**Japan**

Electrolux Japan Ltd.  
Domestic Appliances Depart-  
ment  
Maruzen Showa Warehouse  
Building  
Tookai 4-5-12, Ota-ku  
143-006 Tokyo  
Tel.: 0120-13-7117  
Fax: 03-3790-5257

**Singapore**

Arzbergh Engineering  
19 Tanglin Road 06-07  
Singapore 247909  
Tel.: 65 7356572  
Fax: 7351124

**Slovenia**

Electrolux Slovenia D.O.O.  
Traska Ul. 132  
1000 Ljubljana  
Tel.: 61 1234 137  
Fax: 61 1234 238

**Thailand**

OLYMPIA Thai Ltd.  
44 Ratchadapisek Road  
10320 Bangkok  
Tel.: 2 513 6111  
Fax: 2 513 2574

**Slovakia Rep.**

Electrolux Slovakia S.R.O.  
Seberiniho 1  
821 03 Bratislava  
Tel.: 02 4333 4322, 4355  
Fax: 02 4333 6976

**South Africa**

AEG (Pty) Ltd.  
55, 12th Road  
P.O. Box 1 02 64  
Kew/Johannesburg 2000  
Tel.: 8069111

**Hungary**

Electrolux Lehel KFT  
(AEG Div)  
Erzsébet Királyné útja 87.  
1142 Budapest  
Tel.: 00361/467-3200

**USA**

ANDI Co. Appl. Inc. East  
65 Campus Plaza  
Edison, New Jersey 0837  
USA/Tel.: (201) 2258839

**Syria**

Masri & Shami  
P.O. Box 24 96  
Damascus  
Tel.: 214080

# Index

## C

- lab Cancelling the programme ..... 22
- lab Care agent ..... 17
- lab Changing the programme ..... 22
- lab Child safety feature ..... 28, 37
- lab Coloureds ..... 11, 24
- lab Conditioner ..... 10, 18, 20
- lab Cottons ..... 11, 16, 24
- lab Curtains ..... 15
- lab Customer Service ..... 27, 28, 51

## D

- lab Delicates ..... 12, 16, 24
- lab Detergent ..... 10, 17, 18, 20
- lab Detergent dispenser drawer ..... 10, 20
- lab Drain ..... 12, 22, 23
- lab Drain pump ..... 10, 34

## E

- lab Easy iron ..... 12, 24
- lab Easy-cares ..... 12, 16, 24
- lab Emergency drainage ..... 33
- lab Energy saving ..... 12

## G

- lab Gentle rinse ..... 12, 25

## H

- lab Handwash ..... 12, 24, 25

## I

- lab In-wash stain treatment ..... 10

## L

- lab Linen ..... 16
- lab Load ..... 13, 24

## N

- lab Net curtains ..... 24

## O

- lab Opening the door ..... 19, 31

## P

- lab Pre-wash ..... 13, 20, 21, 24
  - lab detergent ..... 10, 20
- lab Programme progress display ..... 22

## Q

- lab Quick ..... 13, 21, 22, 24

## R

- lab Rating plate ..... 10, 43, 51
- lab Rinse hold ..... 12, 21, 23
- lab Rinse+ ..... 36
- lab Risk of frost ..... 6, 33

## S

- lab Silk ..... 12, 16, 25
- lab Sluice ..... 15
- lab Softener ..... 10, 20
- lab Spin ..... 18, 23
- lab Spinning ..... 12, 21, 25
- lab Stain ..... 9, 13, 21, 22, 24, 32

## W

- lab Warranty ..... 6, 28, 47
- lab Washing
  - lab coloureds ..... 15
  - lab lightly soiled ..... 9
  - lab normally dirty ..... 9
- lab Washing powder ..... 17
- lab Water
  - lab hardness ..... 9, 17
  - lab softener ..... 9, 17, 20
- lab Wool ..... 12, 16, 24, 25
  - lab hand washable ..... 12, 24

# Service

In the chapter "What to do if..." , some faults are listed which you can remedy yourself. Look there first if a fault occurs. If you do not find any information there, please consult your Customer Service. (You can find the addresses and telephone numbers in the section "Customer Service Centres".)

Always prepare in advance for the discussion. By doing so you will simplify the diagnosis and the decision on whether customer service is necessary.

Note the PNC number and S. number. You will find both on the rating plate on the inside of the door of your washing machine.

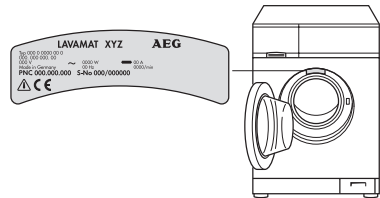

PNC .....

S. No. ....

Answer as precisely as possible:

- What form does the fault take?
- Under what circumstances does the fault occur?

### When do you incur costs even during the warranty period?

- If you could have remedied the fault yourself with the aid of the fault table (see the section "What to do if..."),
- If several journeys by the customer service technician are necessary because for example he did not receive all the important information before his visit and must collect spare parts. These multiple trips can be avoided if you prepare your phone call as described above.

 **From the Electrolux Group. The world's No. 1 choice.**

*The Electrolux Group is the world's largest producer of powered appliances for kitchen, cleaning and outdoor use. More than 55 million Electrolux Group products (such as refrigerators, cookers, washing machines, vacuum cleaners, chain saws and lawn mowers) are sold each year to a value of approx. USD 14 billion in more than 150 countries around the world.*

AEG Hausgeräte GmbH  
Postfach 1036  
D-90327 Nürnberg

<http://www.aeg.hausgeraete.de>

© Copyright by AEG

822 943 723-01-100603-01

Subject to change without notice